

This drawing is confidential and must not be reproduced or used without the consent of EXM

Ce dessin est confidentiel et ne doit pas être reproduit ou utilisé sans le consentement de EXM

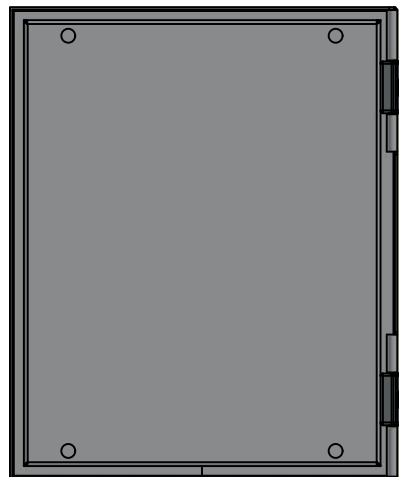

TOP



BACK

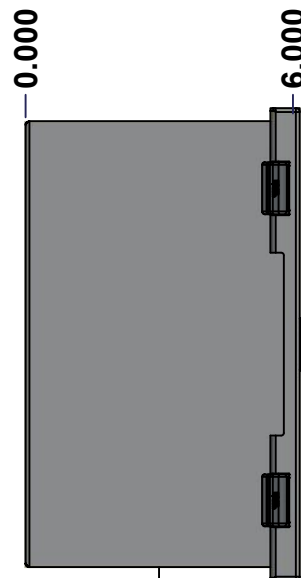

LEFT

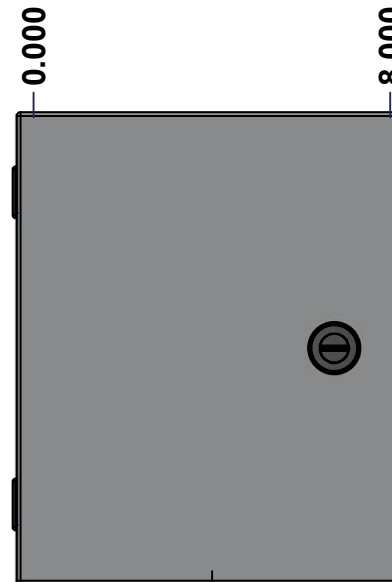

FRONT

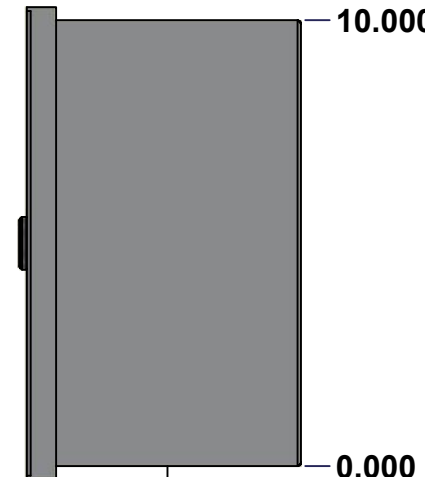

RIGHT

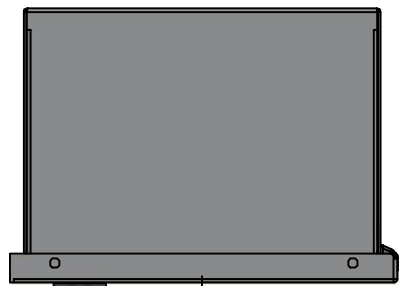

BOTTOM

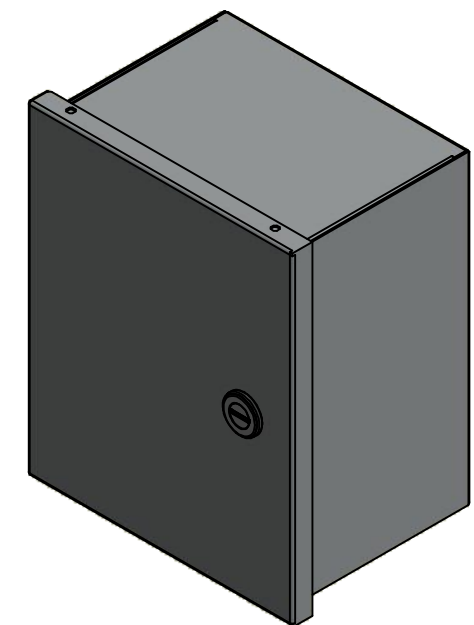

Isometric View

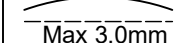
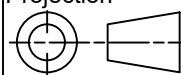

| No. | Revisions | Date | By/Par |
|-----|-----------|------|--------|
| | | | |
| | | | |
| | | | |
| | | | |

| | | |
|----------------------------------------------------------------------------------------------------------------------------------------------------------------------------------------|-------------------------------------------|-------------------------------------------------------------------------------------------------------------------------------------------------------------------------------------------------------------------------------------|
|  Tél: (450) 979-4373 Fax: (450) 979-4626 www.exmweb.com | | Flatness Aplatissement  Max 3.0mm Projection  |
| Customer Client | Date | |
| Drawn By Dessiné Par | BoxCad: BoxCad | Date 12/23/2013 |
| Material Matière | 16 Ga Cold Rolled A1008 CS Type B (1.4mm) | |
| Color Couleur | Asa-61 Grey | Finish Fini Smooth |
| Description 1100 10" x 8" x 6" Assembly | | Detail Rev. |
| Part Number Numéro Pièce | 1100100806 | Rev. 1 0 |

SEE BILL OF MATERIAL ON LAST PAGE

This drawing is confidential and must not be reproduced or used without the consent of EXM

Ce dessin est confidentiel et ne doit pas être reproduit ou utilisé sans le consentement de EXM

| NOTE | |
|------|------------------------------------------------|
| ITEM | DESCRIPTION |
| 1 | NEMA 1 Enclosure |
| 2 | C/W Standard ground standoffs on box and cover |
| 3 | W/O Standard door stiffener |
| 4 | C/W Standard inner panel (Included) |
| 5 | C/W Standard inner panel mounting standoffs |

| No. | Revisions | Date | By/Par |
|-----|-----------|------|--------|
| | | | |
| | | | |
| | | | |
| | | | |
| | | | |
| | | | |

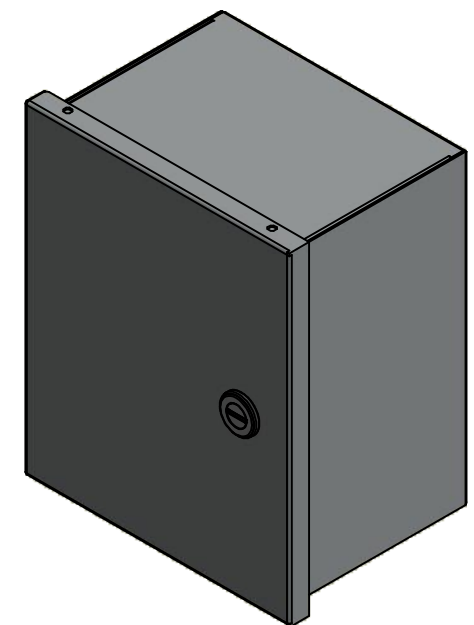

Isometric View



Tél: (450) 979-4373
 Fax: (450) 979-4626
www.exmweb.com



| | |
|---------------------------------------------------------------|-----------------------|
| Customer Client | Date |
| Drawn By / Dessiné Par: BoxCad: BoxCad | Date: 12/23/2013 |
| Material / Matière: 16 Ga Cold Rolled A1008 CS Type B (1.4mm) | |
| Color / Couleur: Asa-61 Grey | Finish / Fini: Smooth |

| PACKING | | |
|----------------------|-----|-----------------------------------------|
| ITEM | QTY | DESCRIPTION |
| Cardboard sleeve | 1 | Top |
| Thermal plastic film | 1 | Use with Packing Tunnel Wrapper Machine |
| Packaging label | 1 | White label with product number |

| Qty | Part Number | Rev | Description |
|------------|-------------|-----|----------------------------------------|
| 1 | 880 SP1008 | 0 | 880 SP1008 - Inner Panel |
| 1 | 1100100806C | 0 | 1100 10" x 8" Cover |
| 1 | STK-K-00200 | 1 | M6 x 8mm Hexagon/Slot Screw (Bag of 6) |
| 1 | 1100100806B | 0 | 1100 10" x 8" x 6" Body |
| 2 | STK-Q-08100 | 1 | M5 Nylon Insert Lock Nut |
| Parts List | | | |

| | |
|-----------------------------------------------|-------------|
| Description: 1100 10" x 8" x 6" Assembly | Detail Rev. |
| Part Number / Numéro Pièce: 1100100806 | Rev. 0 |
| | 2/9 |

This drawing is confidential and must not be reproduced or used without the consent of EXM

Ce dessin est confidentiel et ne doit pas être reproduit ou utilisé sans le consentement de EXM



TOP

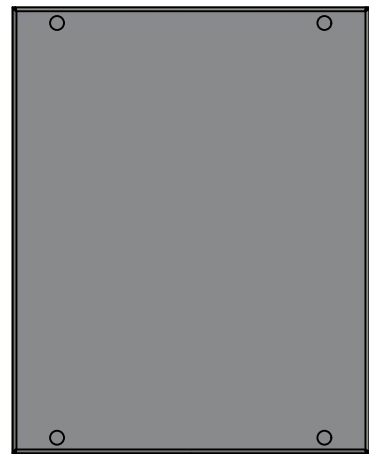

BACK

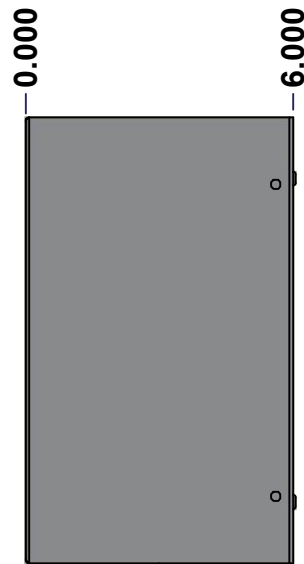

LEFT

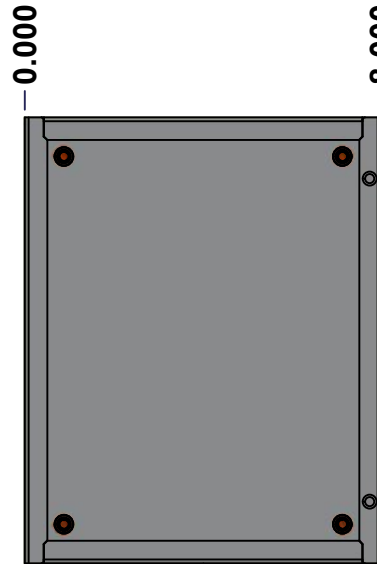

FRONT

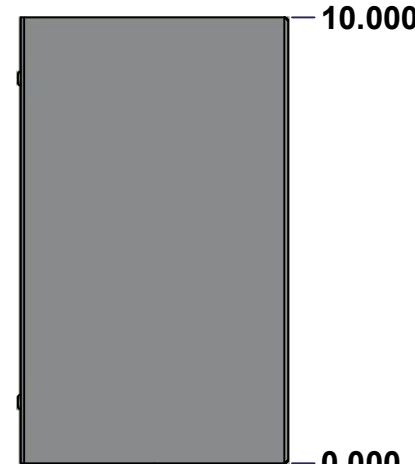

RIGHT



BOTTOM

| No. | Revisions | Date | By/Par |
|-----|-----------|------|--------|
| | | | |
| | | | |
| | | | |
| | | | |

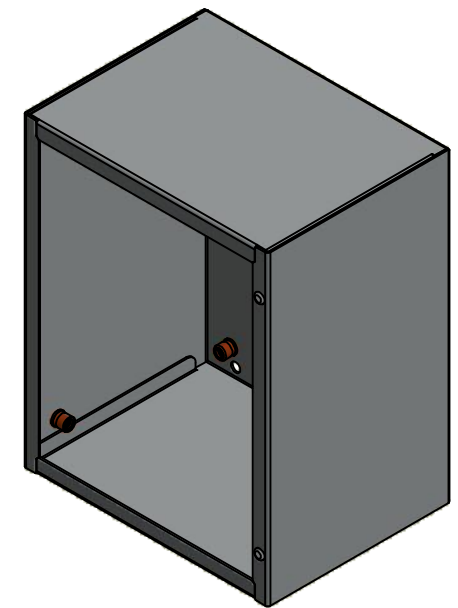

Isometric View



Tél: (450) 979-4373
 Fax: (450) 979-4626
www.exmweb.com

Flatness
Aplatissement

Max 3.0mm

Projection

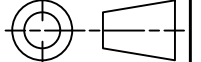

| | |
|---------------------------------------------------------------|-----------------------|
| Customer Client | Date |
| Drawn By / Dessiné Par: BoxCad: BoxCad | Date: 12/23/2013 |
| Material / Matière: 16 Ga Cold Rolled A1008 CS Type B (1.4mm) | |
| Color / Couleur: Asa-61 Grey | Finish / Fini: Smooth |
| Description: 1100 10" x 8" x 6" Body | Detail Rev. |
| Part Number / Numéro Pièce: 1100100806B | Rev. 0 |

SEE BILL OF MATERIAL ON LAST PAGE

This drawing is confidential and must not be reproduced or used without the consent of EXM

Ce dessin est confidentiel et ne doit pas être reproduit ou utilisé sans le consentement de EXM

| STANDARD FEATURES ARE NOT LISTED IN THIS HOLE TABLE | | | |
|------------------------------------------------------------|-------|-------|-----------------------------|
| HOLE TABLE - LEFT VIEW (CUSTOM FEATURE ONLY) | | | |
| CUT-OUT | XDIM | YDIM | DESCRIPTION |
| 1 | 4.937 | 0.875 | STANDOFF M6 x 10mm (Inside) |

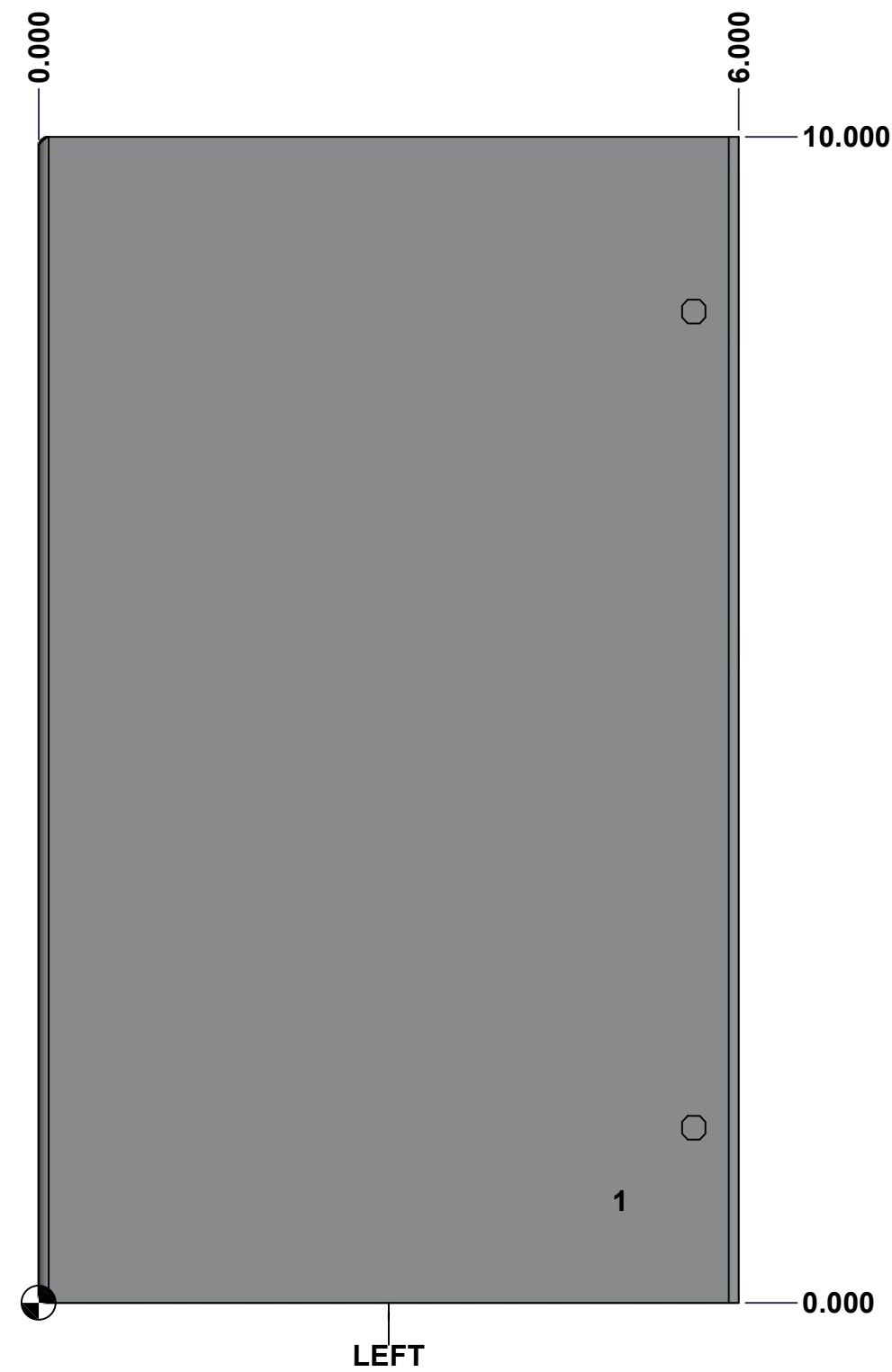

| | | | |
|--|-----------------------------|----------|--------|
| | Description | Status | |
| | 1100 10" x 8" x 6" Body | (NULL) | |
| | Part Number Numéro Pièce | Rev. | |
| | 1100100806B | 0 | 4 9 |

This drawing is confidential and must not be reproduced or used without the consent of EXM

Ce dessin est confidentiel et ne doit pas être reproduit ou utilisé sans le consentement de EXM

STANDARD FEATURES ARE NOT LISTED IN THIS HOLE TABLE

HOLE TABLE - BACK VIEW (CUSTOM FEATURE ONLY)

| CUT-OUT | XDIM | YDIM | DESCRIPTION |
|---------|-------|-------|--------------------------------|
| 1 | 0.875 | 9.125 | IP STANDOFF M6 x 10mm (Inside) |
| 2 | 0.875 | 0.875 | IP STANDOFF M6 x 10mm (Inside) |
| 3 | 7.125 | 0.875 | IP STANDOFF M6 x 10mm (Inside) |
| 4 | 7.125 | 9.125 | IP STANDOFF M6 x 10mm (Inside) |
| ----- | | | |
| 5 | 7.000 | 0.344 | RND Ø0.305 |
| 6 | 7.000 | 9.656 | RND Ø0.305 |
| 7 | 1.000 | 9.656 | RND Ø0.305 |
| 8 | 1.000 | 0.344 | RND Ø0.305 |

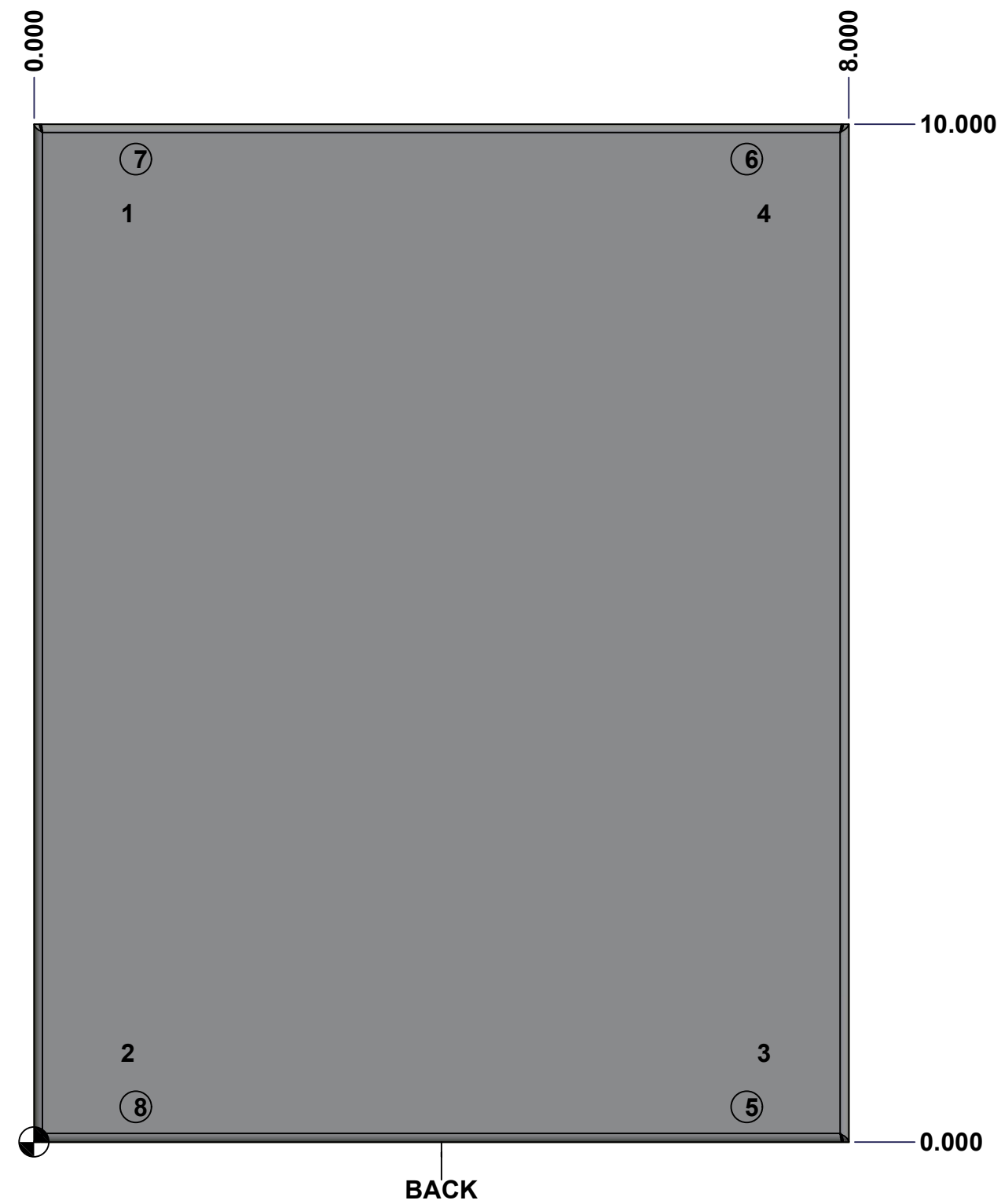

| | | |
|--|---------------------------------------------------|------------------------|
| | Description 1100 10" x 8" x 6" Body | Status (NULL) |
| | Part Number Numéro Pièce 1100100806B | Rev. 5 0 / 9 |

This drawing is confidential and must not be reproduced or used without the consent of EXM

Ce dessin est confidentiel et ne doit pas être reproduit ou utilisé sans le consentement de EXM

| No. | Revisions | Date | By/Par |
|-----|-----------|------|--------|
| | | | |
| | | | |
| | | | |
| | | | |
| | | | |

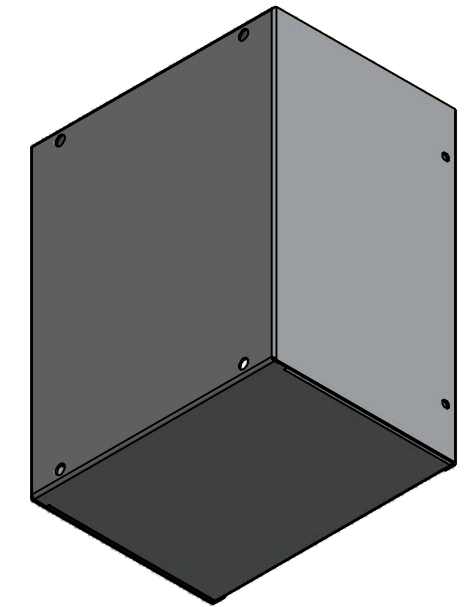

Isometric View

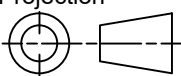

| | | |
|----------------------------------------------------------------------------------------------------------------------------------------------------------------------------------------|-------------------------------------------|---------------------------------------------------------------------------------------|
|  Tél: (450) 979-4373 Fax: (450) 979-4626 www.exmweb.com | Flatness Aplatissement | Max 3.0mm |
| | Projection |  |
| Customer Client | Date | |
| Drawn By Dessiné Par | BoxCad: BoxCad | Date 12/23/2013 |
| Material Matière | 16 Ga Cold Rolled A1008 CS Type B (1.4mm) | |
| Color Couleur | Asa-61 Grey | Finish Fini Smooth |
| Description | Detail Rev. | |
| 1100 10" x 8" x 6" Body | | |
| Part Number Numéro Pièce | Rev. | 6 |
| 1100100806B | 0 | 9 |

| Qty | Part Number | Rev | Description |
|------------|---------------|-----|-------------------------------------|
| 1 | 1100100806B-P | 0 | 1100 10" x 8" x 6" Body Part |
| 1 | STK-P-02400S | 0 | Powder Paint (Asa-61 Grey / Smooth) |
| 2 | STK-Q-77110 | 1 | 5412 ES Cover Plastic Plug |
| 5 | STK-Q-08350 | 5 | Standoff M6 x 10mm |
| Parts List | | | |

This drawing is confidential and must not be reproduced or used without the consent of EXM

Ce dessin est confidentiel et ne doit pas être reproduit ou utilisé sans le consentement de EXM



TOP

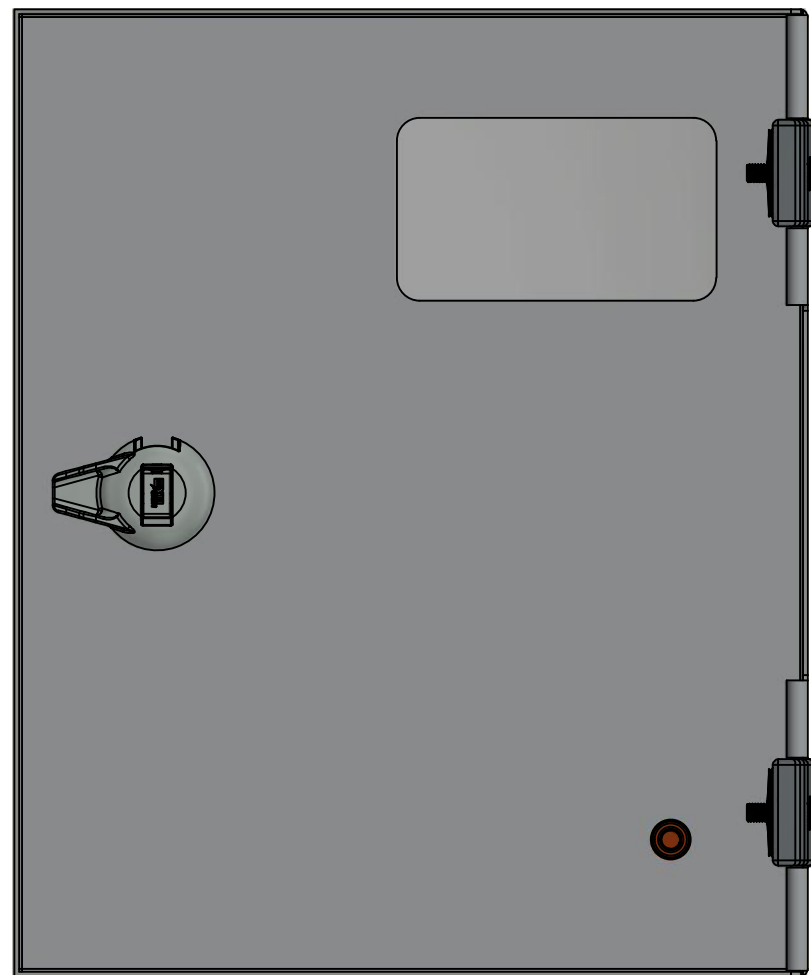

BACK



BOTTOM

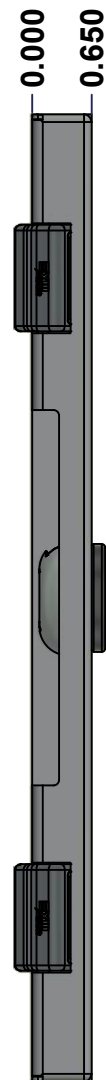

LEFT



FRONT



| No. | Revisions | Date | By/Par |
|-----|-----------|------|--------|
| | | | |
| | | | |
| | | | |
| | | | |
| | | | |



Isometric View



Tél: (450) 979-4373
 Fax: (450) 979-4626
www.exmweb.com

Flatness
Aplatissement

Max 3.0mm

Projection



| | |
|---------------------------------------------------------------|------------------|
| Customer Client | Date |
| Drawn By / Dessiné Par: BoxCad: BoxCad | Date: 12/23/2013 |
| Material / Matière: 16 Ga Cold Rolled A1008 CS Type B (1.4mm) | |

| | |
|------------------------------|-----------------------|
| Color / Couleur: Asa-61 Grey | Finish / Fini: Smooth |
|------------------------------|-----------------------|

| | |
|----------------------------------|-------------|
| Description: 1100 10" x 8" Cover | Detail Rev. |
|----------------------------------|-------------|

| | | | |
|-----------------------------------------|--------|---|---|
| Part Number / Numéro Pièce: 1100100806C | Rev. 0 | 7 | 9 |
|-----------------------------------------|--------|---|---|

SEE BILL OF MATERIAL ON LAST PAGE

This drawing is confidential and must not be reproduced or used without the consent of EXM

Ce dessin est confidentiel et ne doit pas être reproduit ou utilisé sans le consentement de EXM

| STANDARD FEATURES ARE NOT LISTED IN THIS HOLE TABLE | | | |
|-----------------------------------------------------|-------|-------|-----------------------------|
| HOLE TABLE - FRONT VIEW (CUSTOM FEATURE ONLY) | | | |
| CUT-OUT | XDIM | YDIM | DESCRIPTION |
| 1 | 1.500 | 1.500 | STANDOFF M6 x 10mm (Inside) |
| 2 | 7.125 | 5.296 | LOCK 880 SCQ1-SLZ @ 0.0° |

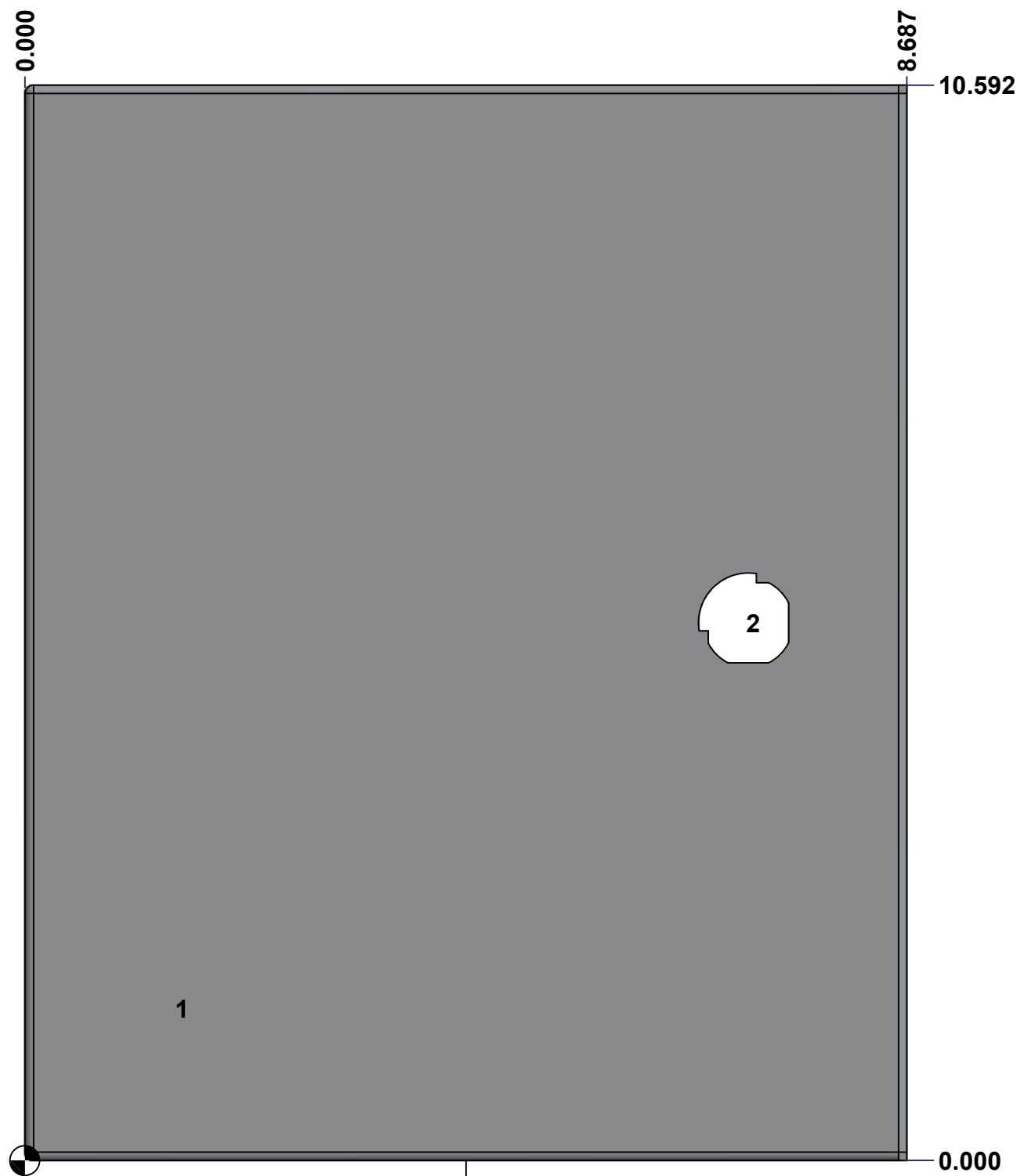

FRONT

| | | | |
|--|-----------------------------|----------|--------|
| | Description | Status | |
| | 1100 10" x 8" x 6" Cover | (NULL) | |
| | Part Number Numéro Pièce | Rev. | |
| | 1100100806C | 0 | 8 9 |

This drawing is confidential and must not be reproduced or used without the consent of EXM

Ce dessin est confidentiel et ne doit pas être reproduit ou utilisé sans le consentement de EXM

| No. | Revisions | Date | By/Par |
|-----|-----------|------|--------|
| | | | |
| | | | |
| | | | |
| | | | |
| | | | |

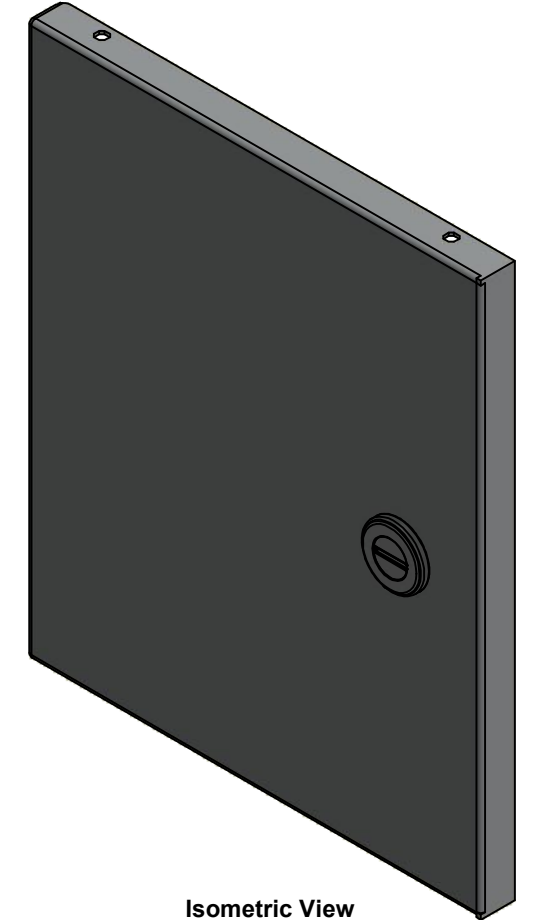

Isometric View

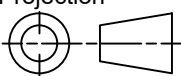
| | | |
|----------------------------------------------------------------------------------------------------------------------------------------------------------------------------------------|-------------------------------------------|---------------------------------------------------------------------------------------|
|  Tél: (450) 979-4373 Fax: (450) 979-4626 www.exmweb.com | Flatness Aplatissement | Max 3.0mm |
| | Projection |  |
| Customer Client | Date | |
| Drawn By Dessiné Par | BoxCad: BoxCad | Date 12/23/2013 |
| Material Matière | 16 Ga Cold Rolled A1008 CS Type B (1.4mm) | |
| Color Couleur | Asa-61 Grey | Finish Fini Smooth |
| Description | Detail Rev. | |
| 1100 10" x 8" Cover | | |
| Part Number Numéro Pièce | Rev. | 9 |
| 1100100806C | 0 | 9 |

| Qty | Part Number | Rev | Description |
|------------|---------------|-----|----------------------------------------|
| 1 | 880 SCQ1-SLZ | 0 | 1100 1/4 Turn Lock |
| 1 | STK-Q-08350 | 5 | Standoff M6 x 10mm |
| 1 | STK-S-00100 | 0 | 3.5" x 2" Silver Milar Flexcon Sticker |
| 1 | STK-P-02400S | 0 | Powder Paint (Asa-61 Grey / Smooth) |
| 1 | 1100100806C-P | 0 | 1100 10" x 8" x 6" Cover Part |
| 2 | STK-A-33033 | 4 | 5412 ESMCH Hinge |
| Parts List | | | |

This drawing is confidential and must not be reproduced or used without the consent of EXM

Ce dessin est confidentiel et ne doit pas être reproduit ou utilisé sans le consentement de EXM

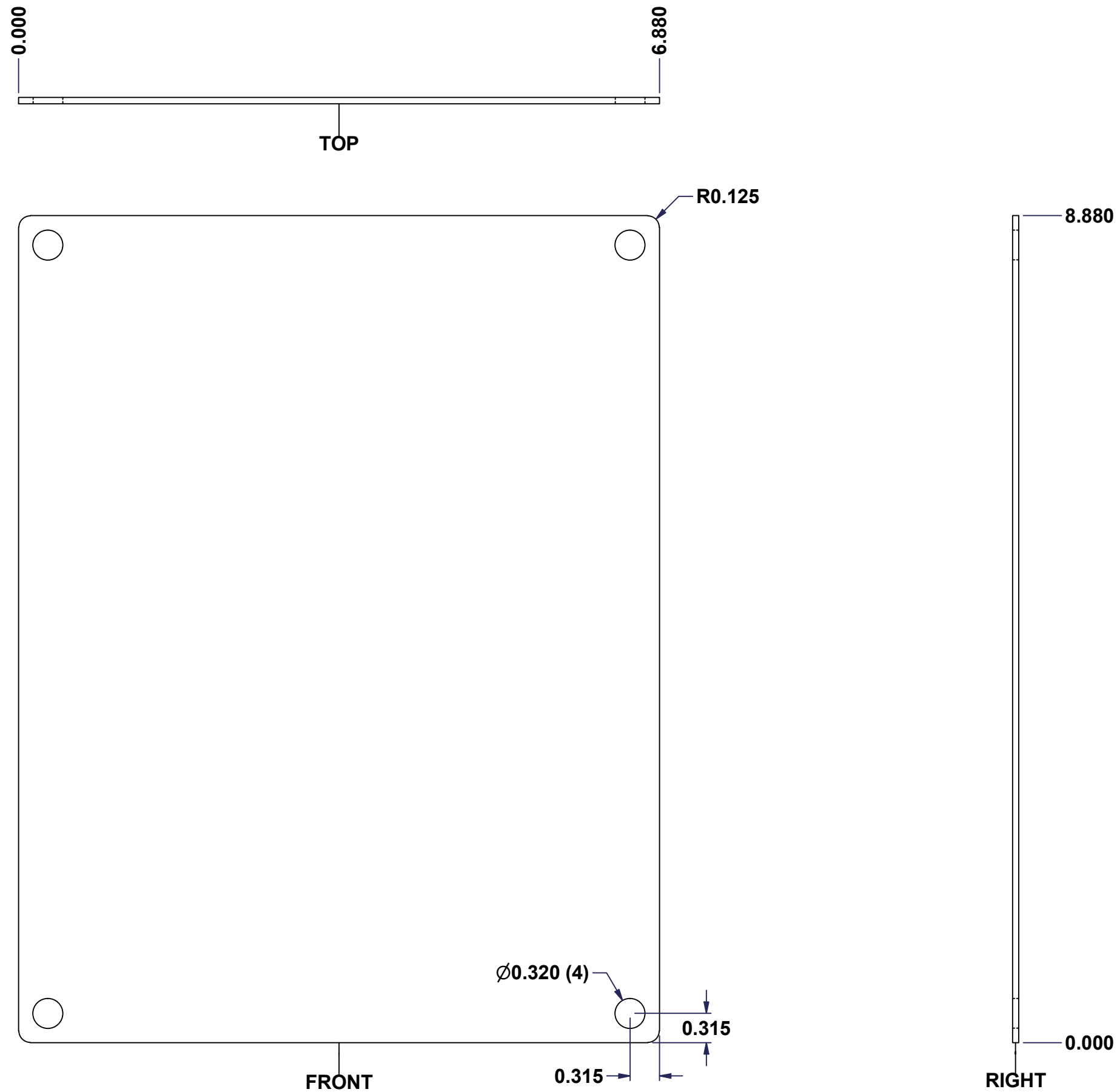

| No. | Revisions | Date | By/Par |
|-----|-----------|------|--------|
| | | | |
| | | | |
| | | | |
| | | | |
| | | | |

Isometric View

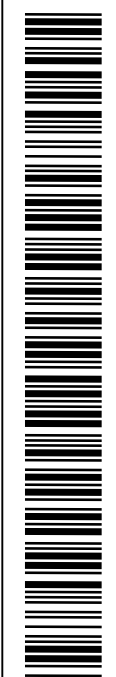

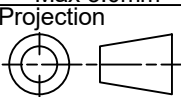
| | |
|----------------------------------------------------------------------------------------------------------------------------------------------------|-----------------------------------------------------------------------------------------------------|
|  Tél: (450) 979-4373 Fax: (450) 979-4626 www.exmweb.com | Flatness Aplatissement Max 3.0mm |
| | Projection  |
| Customer Client | Date |
| Drawn By / Dessiné Par: BoxCad | Date: 23-Jan-07 |
| Material / Matière: 14 Ga Cold Rolled A1008 CS Type B | |
| Color / Couleur: White | Finish / Fini: Smooth |
| Description: 880 SP1008 - Inner Panel | |
| Detail Rev. | |
| Part Number / Numéro Pièce: 880 SP1008 | Rev. 1 0 |

SEE BILL OF MATERIAL ON LAST PAGE

This drawing is confidential and must not be reproduced or used without the consent of EXM

Ce dessin est confidentiel et ne doit pas être reproduit ou utilisé sans le consentement de EXM

| No. | Revisions | Date | By/Par |
|-----|-----------|------|--------|
| | | | |
| | | | |
| | | | |
| | | | |
| | | | |

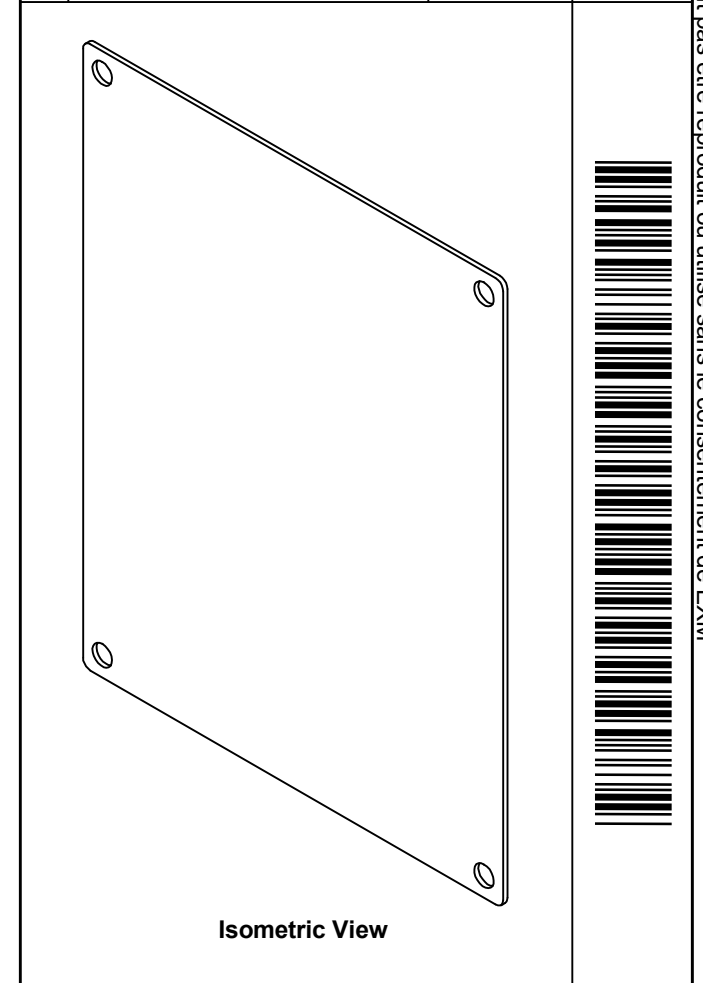

| | | |
|----------------------------------------------------------------------------------------------------------------------------------------------------|--|----------------------------------------|
|  Tél: (450) 979-4373 Fax: (450) 979-4626 www.exmweb.com | | Flatness Aplatissement Max 3.0mm |
| Customer Client | | Date |
| Drawn By / Dessiné Par: BoxCad | | Date: 23-Jan-07 |
| Material / Matière: 14 Ga Cold Rolled A1008 CS Type B | | |
| Color / Couleur: White | | Finish / Fini: Smooth |
| Description: 880 SP1008 - Inner Panel | | Detail Rev. |
| Part Number / Numéro Pièce: 880 SP1008 | | Rev. 0 / 2 |

| Qty | Part Number | Rev | Description |
|------------|--------------|-----|-------------------------------|
| 1 | STK-P-02401S | 0 | Powder Paint (White / Smooth) |
| 1 | 880 SP1008-P | 0 | 880 SP1008 - Inner Panel Part |
| Parts List | | | |