

This drawing is confidential and must not be reproduced or used without the consent of EXM

Ce dessin est confidentiel et ne doit pas être reproduit ou utilisé sans le consentement de EXM

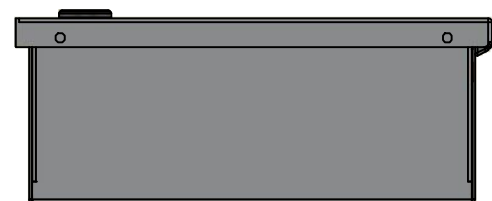

TOP

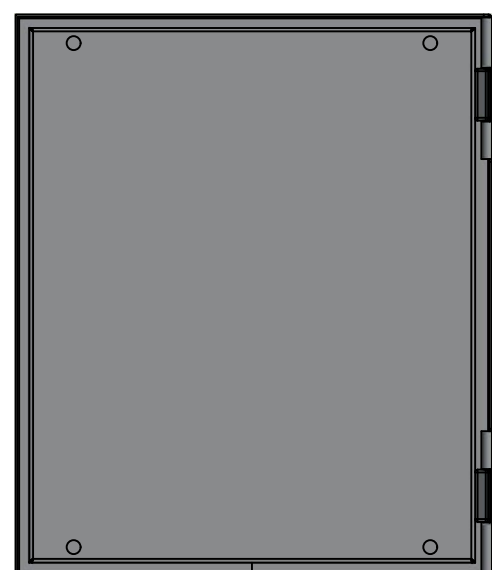

BACK



BOTTOM

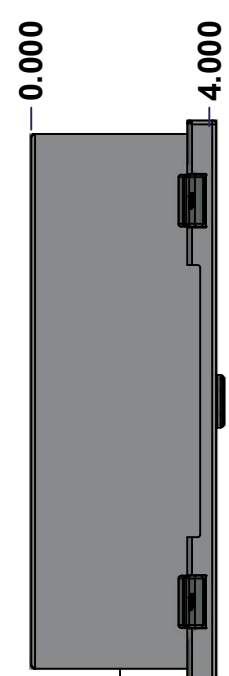

LEFT

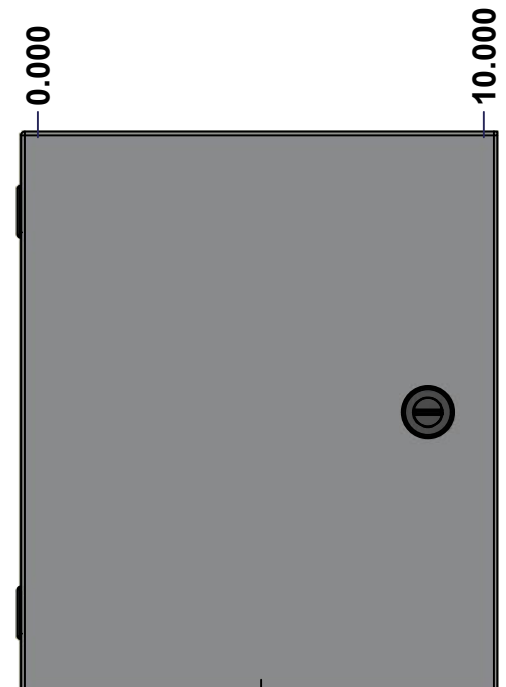

FRONT

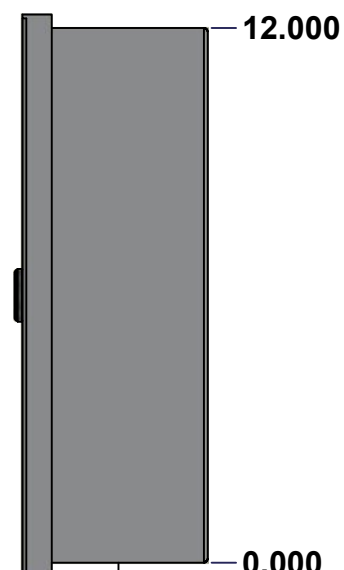

RIGHT

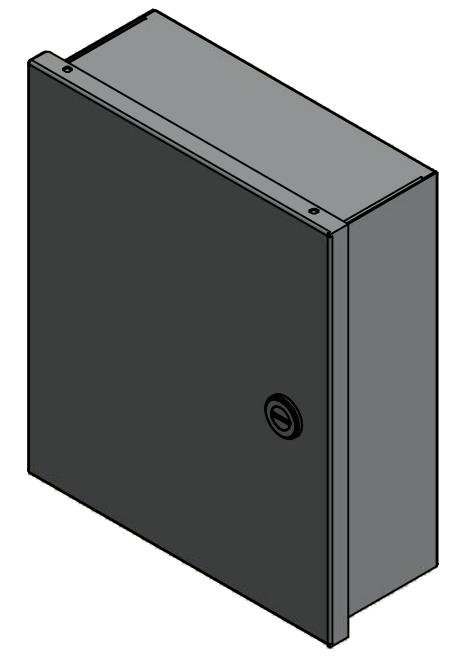

Isometric View

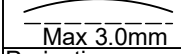
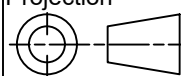

No.	Revisions	Date	By/Par

 Tél: (450) 979-4373 Fax: (450) 979-4626 www.exmweb.com		Flatness Aplatissement  Max 3.0mm Projection 
Customer Client	Date	
Drawn By Dessiné Par	BoxCad: BoxCad	Date 9/10/2014
Material Matière	16 Ga Cold Rolled A1008 CS Type B (1.4mm)	
Color Couleur	Asa-61 Grey	Finish Fini Smooth
Description 1100 12" x 10" x 4" Assembly		Detail Rev.
Part Number Numéro Pièce	1100121004	Rev. 1 0 / 9

SEE BILL OF MATERIAL ON LAST PAGE

This drawing is confidential and must not be reproduced or used without the consent of EXM

Ce dessin est confidentiel et ne doit pas être reproduit ou utilisé sans le consentement de EXM

NOTE	
ITEM	DESCRIPTION
1	NEMA 1 Enclosure
2	C/W Standard ground standoffs on box and cover
3	W/O Standard door stiffener
4	C/W Standard inner panel (Included)
5	C/W Standard inner panel mounting standoffs

No.	Revisions	Date	By/Par

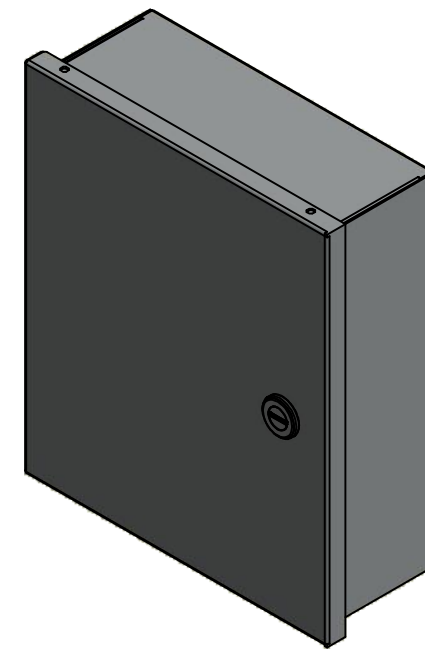

Isometric View



Tél: (450) 979-4373
 Fax: (450) 979-4626
www.exmweb.com

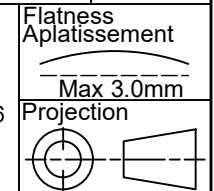

Customer Client	Date
Drawn By / Dessiné Par: BoxCad: BoxCad	Date: 9/10/2014
Material / Matière: 16 Ga Cold Rolled A1008 CS Type B (1.4mm)	

Color / Couleur: Asa-61 Grey	Finish / Fini: Smooth
Description: 1100 12" x 10" x 4" Assembly	Detail Rev.
Part Number / Numéro Pièce: 1100121004	Rev. 0

PACKING		
ITEM	QTY	DESCRIPTION
Cardboard sleeve	1	Top
Thermal plastic film	1	Use with Packing Tunnel Wrapper Machine
Packaging label	1	White label with product number

Qty	Part Number	Rev	Description
1	880 SP1210	0	880 SP1210 - Inner Panel
1	1100121004C	0	1100 12" x 10" Cover
1	STK-K-00200	1	M6 x 8mm Hexagon/Slot Screw (Bag of 6)
1	1100121004B	0	1100 12" x 10" x 4" Body
2	STK-Q-08100	1	M5 Nylon Insert Lock Nut

Parts List

This drawing is confidential and must not be reproduced or used without the consent of EXM

Ce dessin est confidentiel et ne doit pas être reproduit ou utilisé sans le consentement de EXM



TOP



BACK

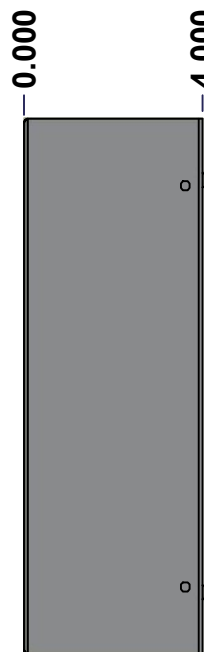

LEFT

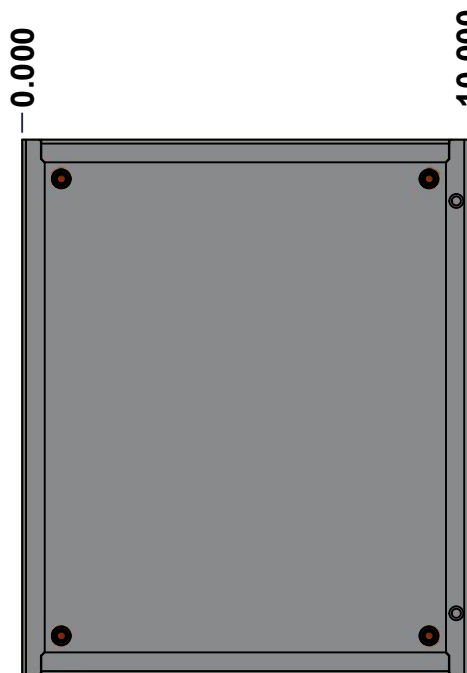

FRONT

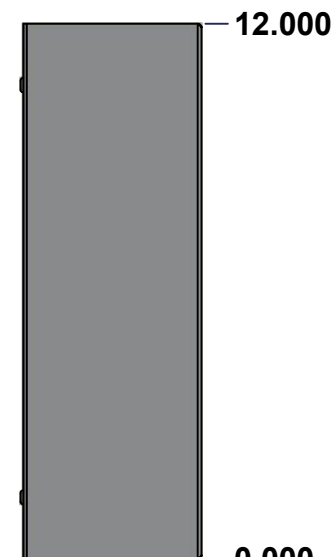

RIGHT



BOTTOM

No.	Revisions	Date	By/Par

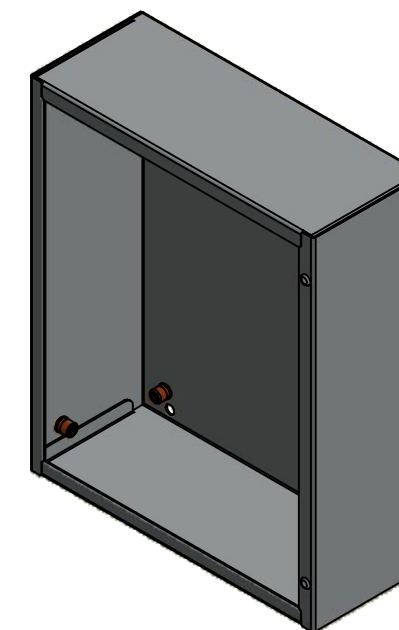

Isometric View



Tél: (450) 979-4373
 Fax: (450) 979-4626
www.exmweb.com

Flatness
Aplatissement

Max 3.0mm

Projection



Customer Client	Date
Drawn By Dessiné Par BoxCad: BoxCad	Date 9/10/2014
Material Matière 16 Ga Cold Rolled A1008 CS Type B (1.4mm)	

Color Couleur Asa-61 Grey	Finish Fini Smooth
------------------------------	-----------------------

Description 1100 12" x 10" x 4" Body	Detail Rev.
---	-------------

Part Number Numéro Pièce 1100121004B	Rev. 0	3	9
---	--------	---	---

SEE BILL OF MATERIAL ON LAST PAGE

This drawing is confidential and must not be reproduced or used without the consent of EXM

Ce dessin est confidentiel et ne doit pas être reproduit ou utilisé sans le consentement de EXM

STANDARD FEATURES ARE NOT LISTED IN THIS HOLE TABLE			
HOLE TABLE - LEFT VIEW (CUSTOM FEATURE ONLY)			
CUT-OUT	XDIM	YDIM	DESCRIPTION
1	2.937	0.875	STANDOFF M6 x 10mm (Inside)

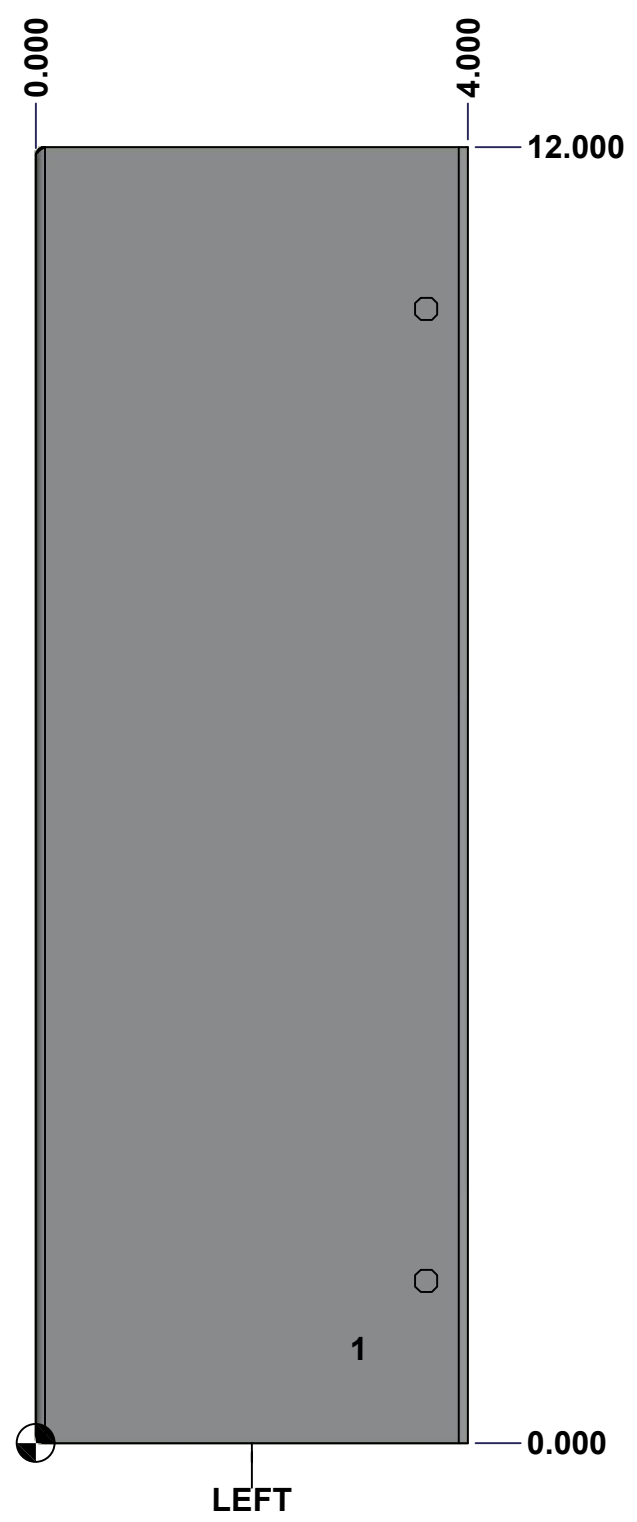

	Description	Status	
	1100 12" x 10" x 4" Body	(NULL)	
	Part Number Numéro Pièce	Rev.	
	1100121004B	0	4 9

This drawing is confidential and must not be reproduced or used without the consent of EXM

Ce dessin est confidentiel et ne doit pas être reproduit ou utilisé sans le consentement de EXM

STANDARD FEATURES ARE NOT LISTED IN THIS HOLE TABLE

HOLE TABLE - BACK VIEW (CUSTOM FEATURE ONLY)

CUT-OUT	XDIM	YDIM	DESCRIPTION
1	0.875	11.125	IP STANDOFF M6 x 10mm (Inside)
2	0.875	0.875	IP STANDOFF M6 x 10mm (Inside)
3	9.125	0.875	IP STANDOFF M6 x 10mm (Inside)
4	9.125	11.125	IP STANDOFF M6 x 10mm (Inside)

5	9.000	0.344	RND Ø0.305
6	9.000	11.656	RND Ø0.305
7	1.000	11.656	RND Ø0.305
8	1.000	0.344	RND Ø0.305

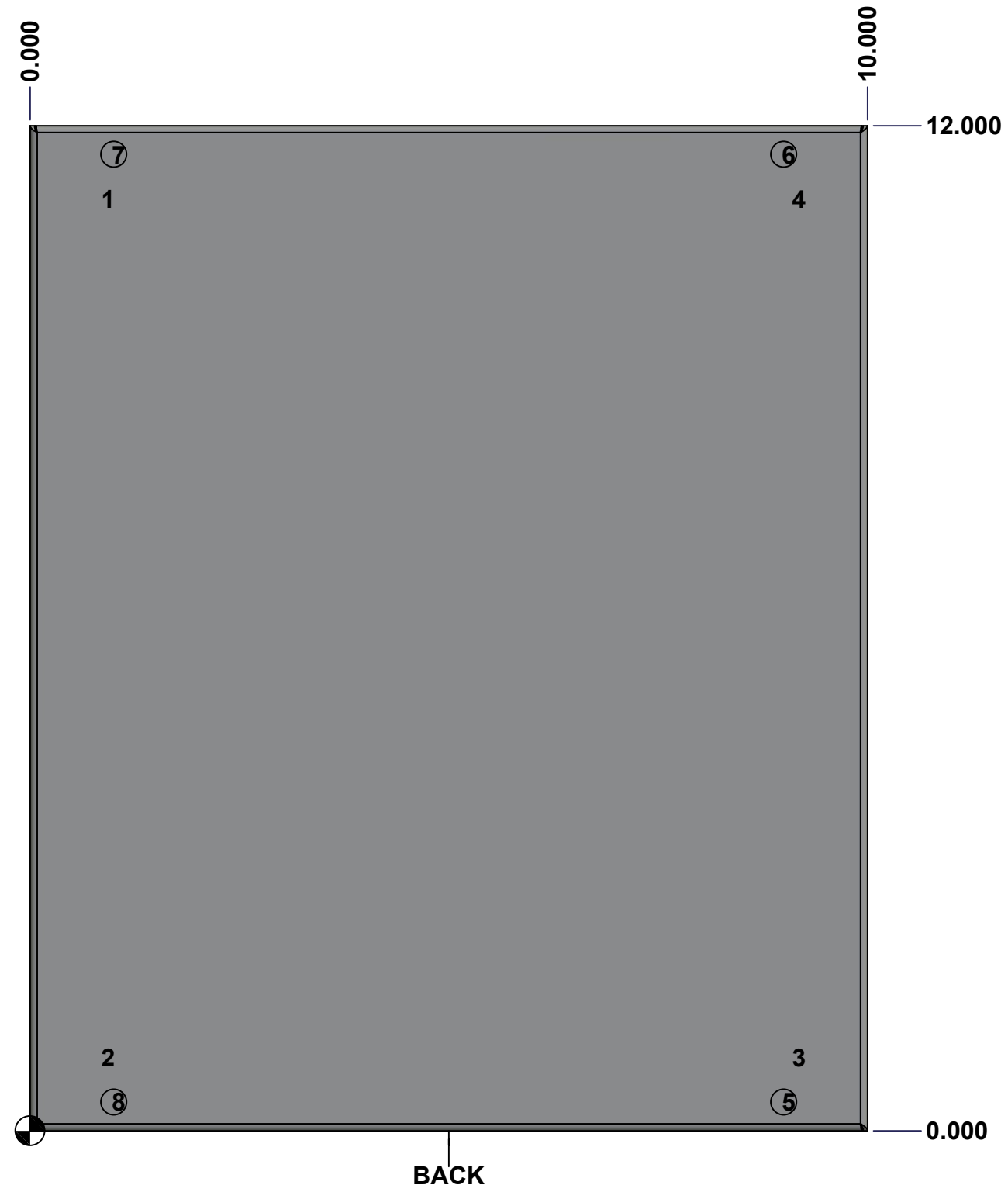

	Description	Status	
	1100 12" x 10" x 4" Body	(NULL)	
	Part Number Numéro Pièce	Rev.	
	1100121004B	0	5 / 9

This drawing is confidential and must not be reproduced or used without the consent of EXM

Ce dessin est confidentiel et ne doit pas être reproduit ou utilisé sans le consentement de EXM

No.	Revisions	Date	By/Par

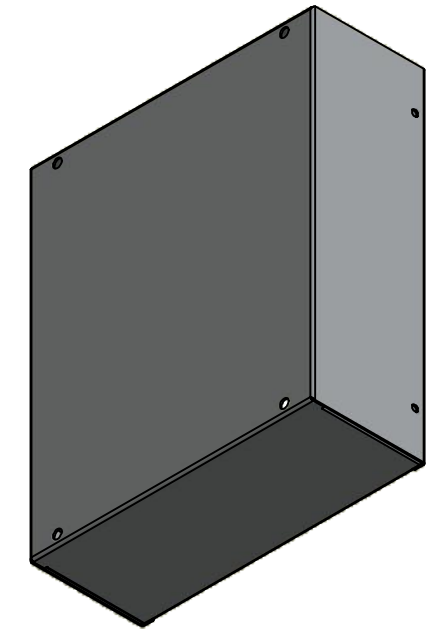

Isometric View



Tél: (450) 979-4373
 Fax: (450) 979-4626
www.exmweb.com

Flatness
Aplatissement
Max 3.0mm
Projection

Customer Client	Date
Drawn By / Dessiné Par: BoxCad: BoxCad	Date: 9/10/2014
Material / Matière: 16 Ga Cold Rolled A1008 CS Type B (1.4mm)	
Color / Couleur: Asa-61 Grey	Finish / Fini: Smooth

Qty	Part Number	Rev	Description
1	1100121004B-P	0	1100 12" x 10" x 4" Body Part
1	STK-P-02400S	0	Powder Paint (Asa-61 Grey / Smooth)
2	STK-Q-77110	1	5412 ES Cover Plastic Plug
5	STK-Q-08350	5	Standoff M6 x 10mm
Parts List			

Description: 1100 12" x 10" x 4" Body	Detail Rev.
Part Number / Numéro Pièce: 1100121004B	Rev. 0 / 6

This drawing is confidential and must not be reproduced or used without the consent of EXM

Ce dessin est confidentiel et ne doit pas être reproduit ou utilisé sans le consentement de EXM



TOP

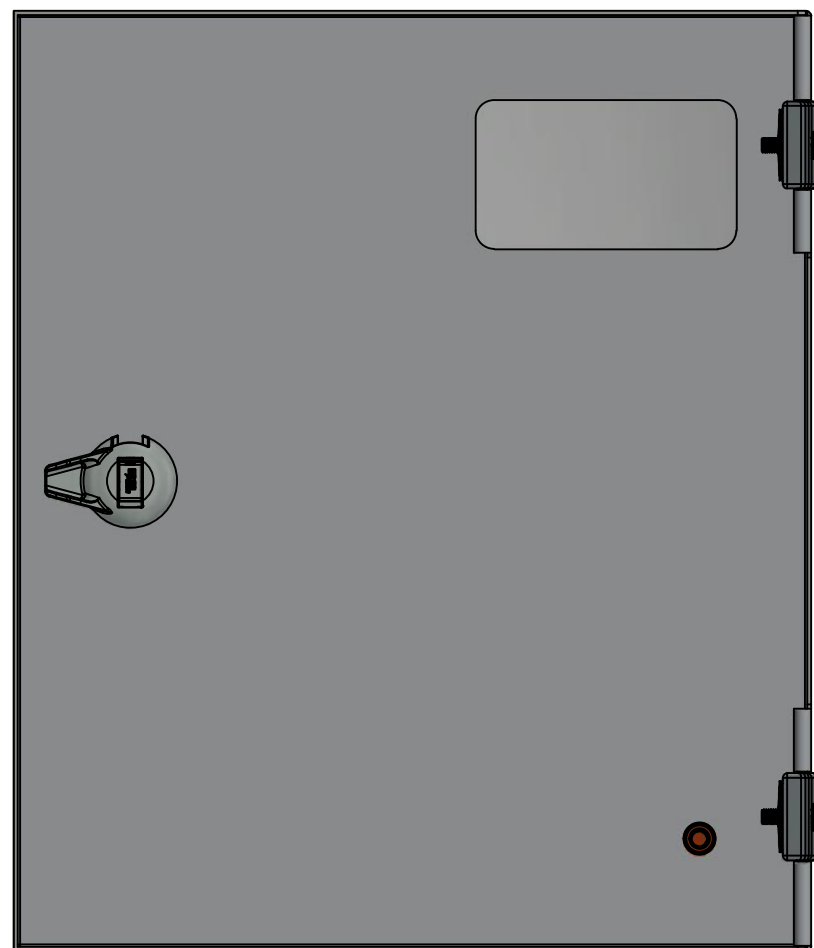

BACK



BOTTOM

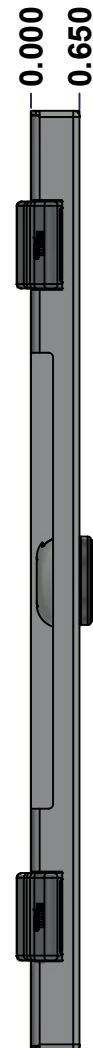

LEFT

0.000
0.650

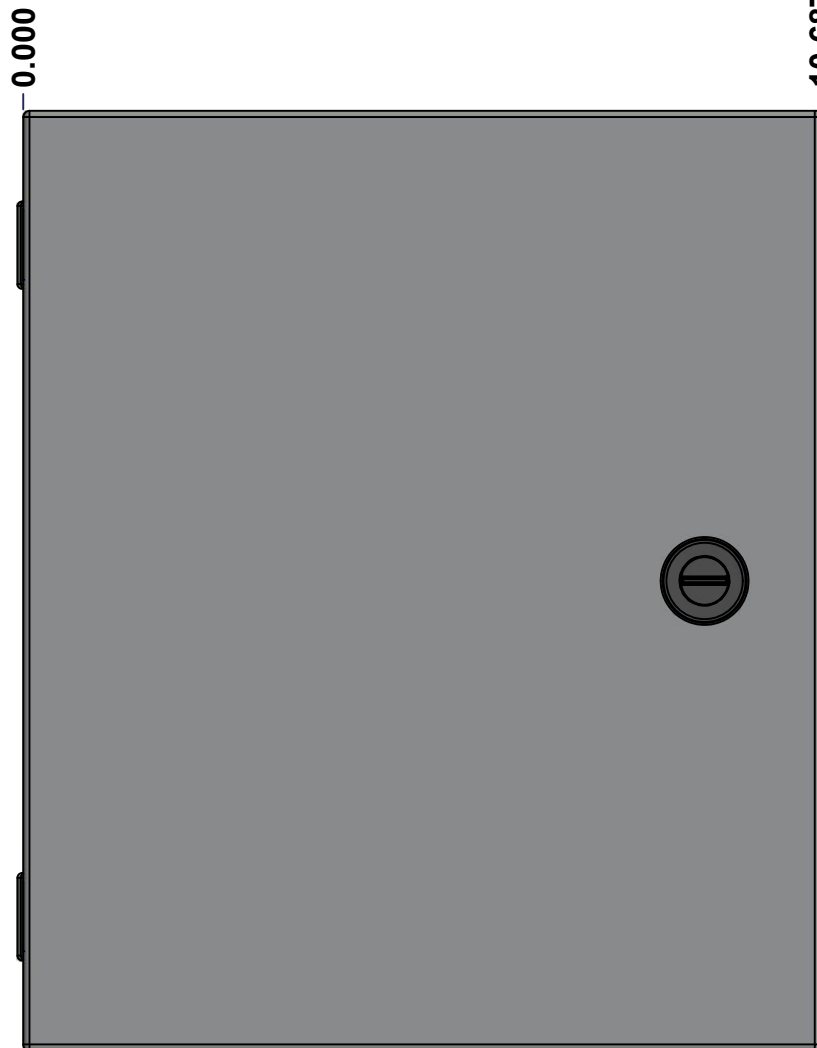

FRONT

0.000

10.687



No.	Revisions	Date	By/Par

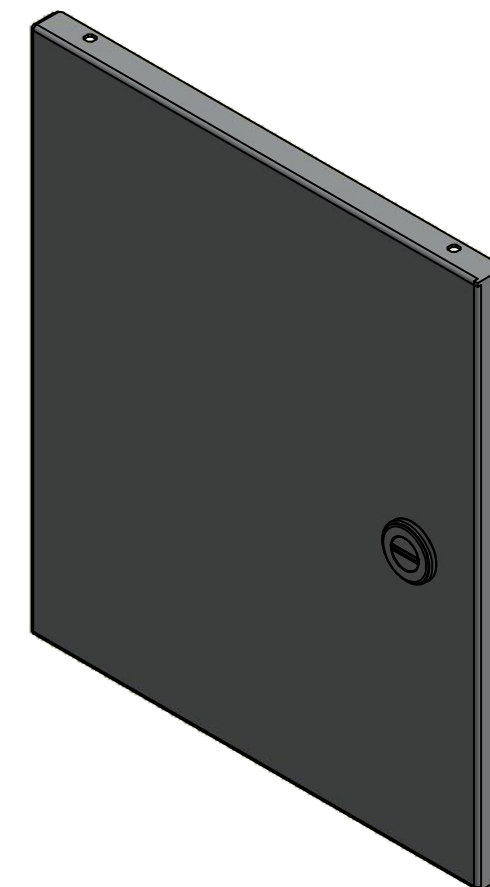

Isometric View



Tél: (450) 979-4373
Fax: (450) 979-4626
www.exmweb.com

Flatness
Aplatissement

Max 3.0mm

Projection



Customer Client	Date
Drawn By / Dessiné Par: BoxCad: BoxCad	Date: 9/10/2014
Material / Matière: 16 Ga Cold Rolled A1008 CS Type B (1.4mm)	

Color / Couleur: Asa-61 Grey	Finish / Fini: Smooth
------------------------------	-----------------------

Description: 1100 12" x 10" Cover	Detail Rev.
-----------------------------------	-------------

Part Number / Numéro Pièce: 1100121004C	Rev. 0	7	9
---	--------	---	---

SEE BILL OF MATERIAL ON LAST PAGE

This drawing is confidential and must not be reproduced or used without the consent of EXM

Ce dessin est confidentiel et ne doit pas être reproduit ou utilisé sans le consentement de EXM

STANDARD FEATURES ARE NOT LISTED IN THIS HOLE TABLE			
HOLE TABLE - FRONT VIEW (CUSTOM FEATURE ONLY)			
CUT-OUT	XDIM	YDIM	DESCRIPTION
1	1.500	1.500	STANDOFF M6 x 10mm (Inside)
2	9.125	6.296	LOCK 880 SCQ1-SLZ @ 0.0°

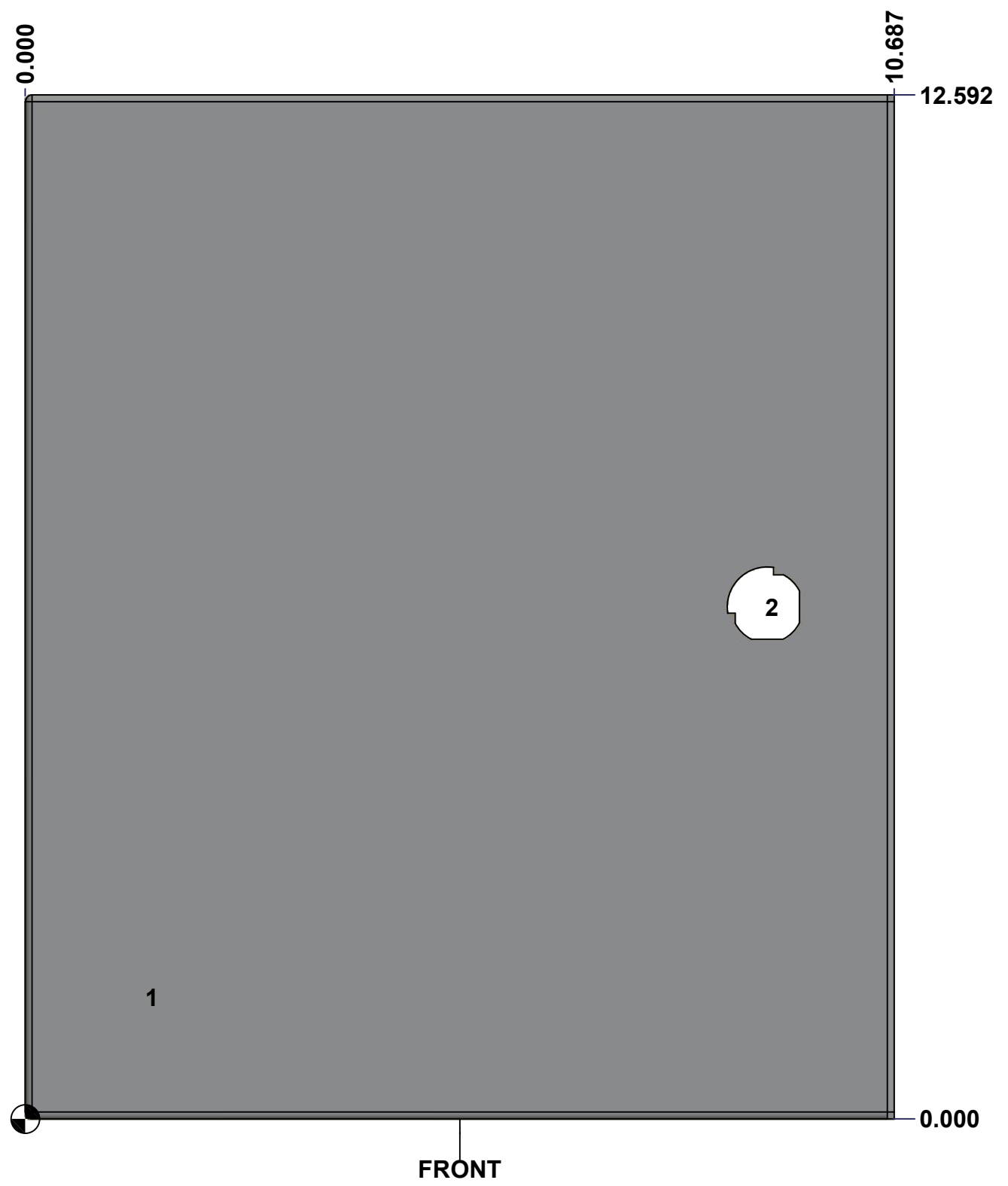

	Description	Status
	1100 12" x 10" x 4" Cover	(NULL)
	Part Number Numéro Pièce	Rev.
	1100121004C	0
		8
		9

This drawing is confidential and must not be reproduced or used without the consent of EXM

Ce dessin est confidentiel et ne doit pas être reproduit ou utilisé sans le consentement de EXM

No.	Revisions	Date	By/Par

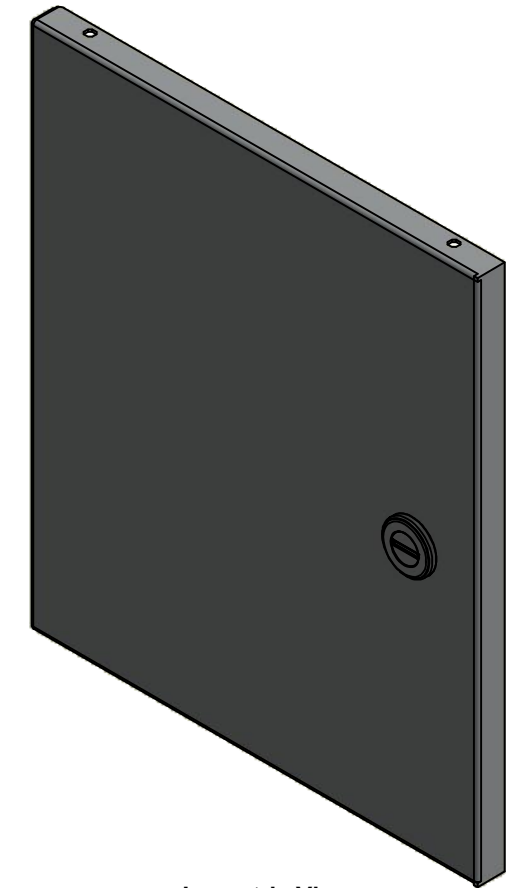

Isometric View

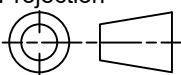

 Tél: (450) 979-4373 Fax: (450) 979-4626 www.exmweb.com		Flatness Aplatissement Max 3.0mm Projection 
Customer Client	Date	
Drawn By Dessiné Par	BoxCad: BoxCad	Date 9/10/2014
Material Matière	16 Ga Cold Rolled A1008 CS Type B (1.4mm)	
Color Couleur	Asa-61 Grey	Finish Fini Smooth
Description		Detail Rev.
1100 12" x 10" Cover		
Part Number Numéro Pièce	Rev.	9
1100121004C	0	9

Qty	Part Number	Rev	Description
1	880 SCQ1-SLZ	0	1100 1/4 Turn Lock
1	STK-Q-08350	5	Standoff M6 x 10mm
1	STK-S-00100	0	3.5" x 2" Silver Milar Flexcon Sticker
1	STK-P-02400S	0	Powder Paint (Asa-61 Grey / Smooth)
1	1100121004C-P	0	1100 12" x 10" x 4" Cover Part
2	STK-A-33033	4	5412 ESMCH Hinge
Parts List			

This drawing is confidential and must not be reproduced or used without the consent of EXM

Ce dessin est confidentiel et ne doit pas être reproduit ou utilisé sans le consentement de EXM

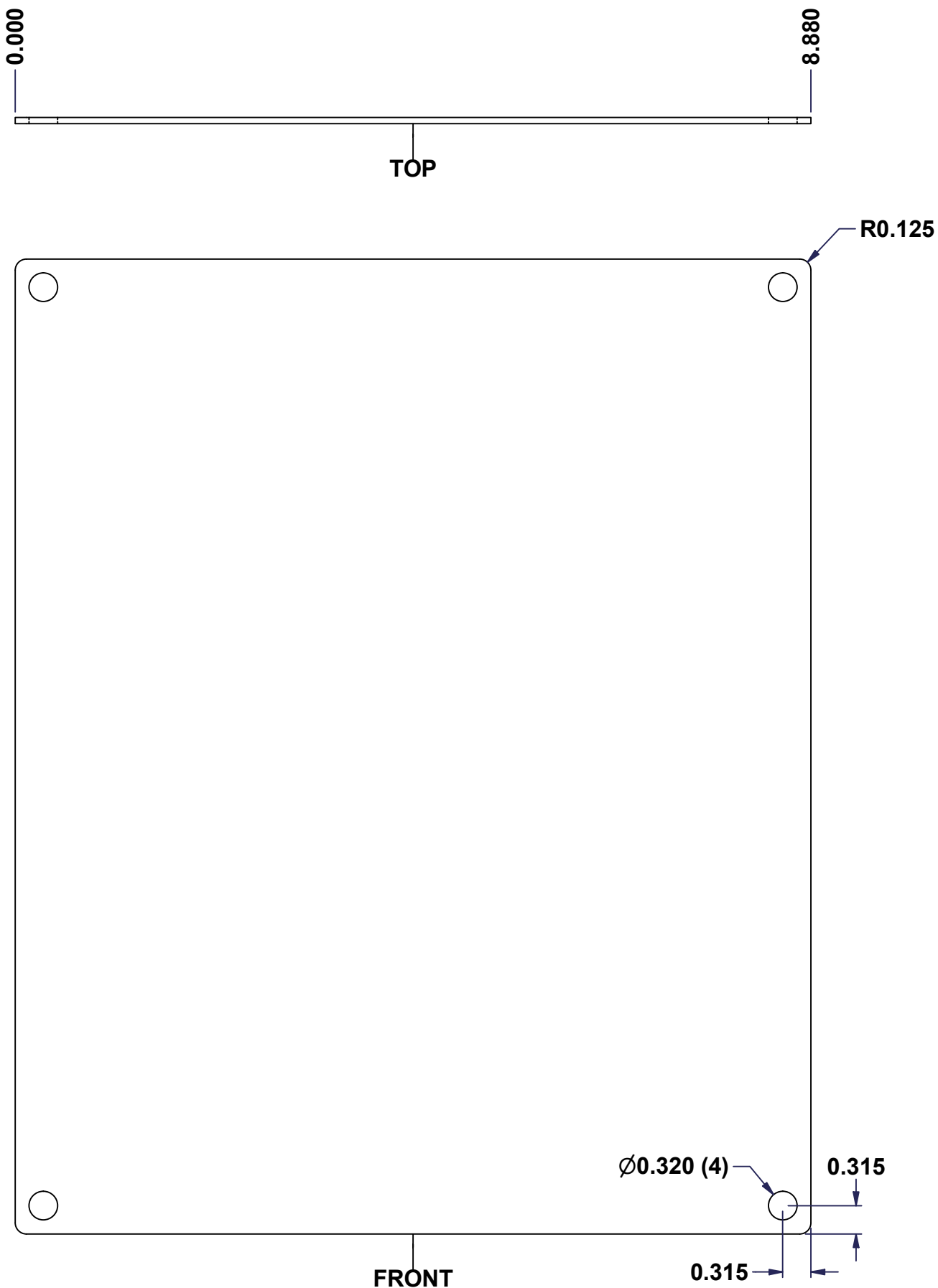

No.	Revisions	Date	By/Par

Isometric View

 Tél: (450) 979-4373 Fax: (450) 979-4626 www.exmweb.com	Flatness Aplatissement Max 3.0mm
	Projection
Customer Client	Date
Drawn By / Dessiné Par: BoxCad	Date: 23-Jan-07
Material / Matière: 14 Ga Cold Rolled A1008 CS Type B	
Color / Couleur: White	Finish / Fini: Smooth
Description: 880 SP1210 - Inner Panel	
Detail Rev.	
Part Number / Numéro Pièce: 880 SP1210	Rev. 1 0

SEE BILL OF MATERIAL ON LAST PAGE

This drawing is confidential and must not be reproduced or used without the consent of EXM

Ce dessin est confidentiel et ne doit pas être reproduit ou utilisé sans le consentement de EXM

No.	Revisions	Date	By/Par

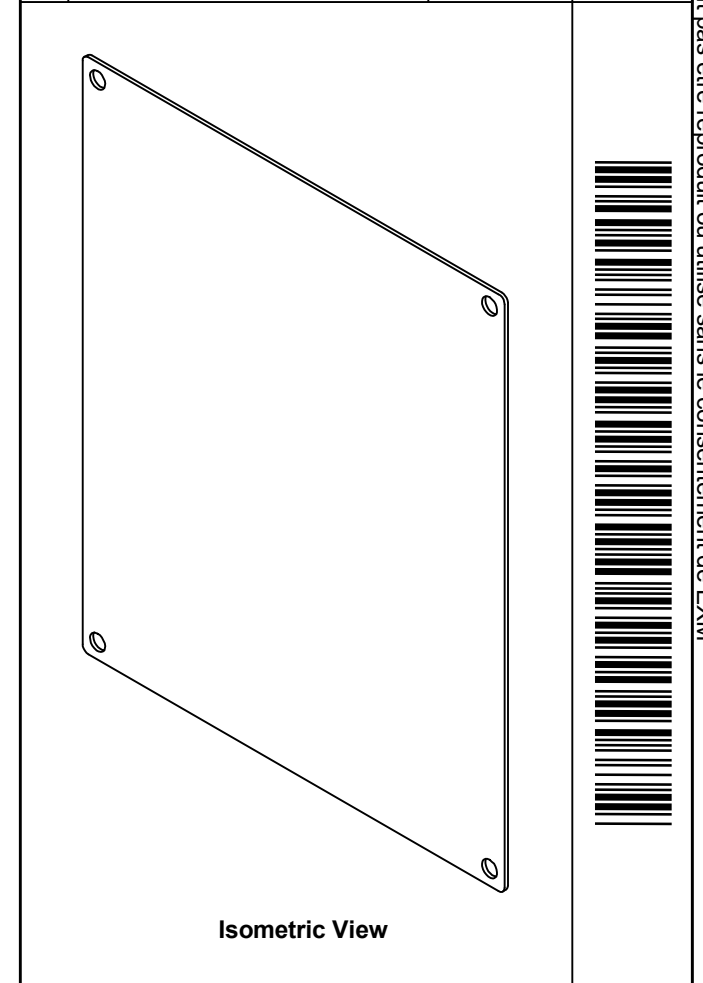

 Tél: (450) 979-4373 Fax: (450) 979-4626 www.exmweb.com		Flatness Aplatissement Max 3.0mm
Customer Client		Date
Drawn By / Dessiné Par: BoxCad		Date: 23-Jan-07
Material / Matière: 14 Ga Cold Rolled A1008 CS Type B		
Color / Couleur: White		Finish / Fini: Smooth
Description: 880 SP1210 - Inner Panel		Detail Rev.
Part Number / Numéro Pièce: 880 SP1210		Rev. 0 / 2

Qty	Part Number	Rev	Description
1	STK-P-02401S	0	Powder Paint (White / Smooth)
1	880 SP1210-P	0	880 SP1210 - Inner Panel Part
Parts List			