

This drawing is confidential and must not be reproduced or used without the consent of EXM

Ce dessin est confidentiel et ne doit pas être reproduit ou utilisé sans le consentement de EXM

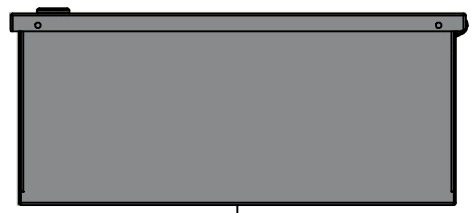

TOP

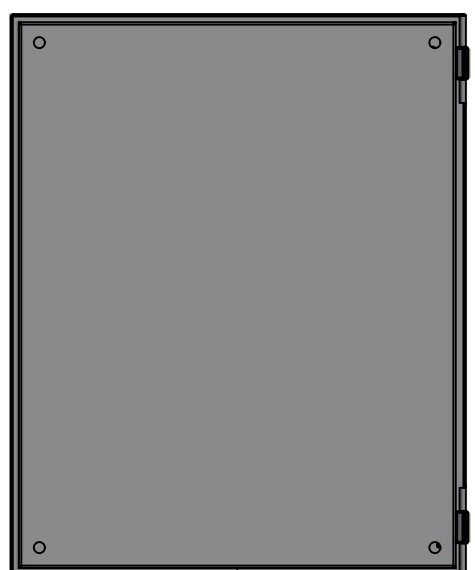

BACK



BOTTOM



LEFT

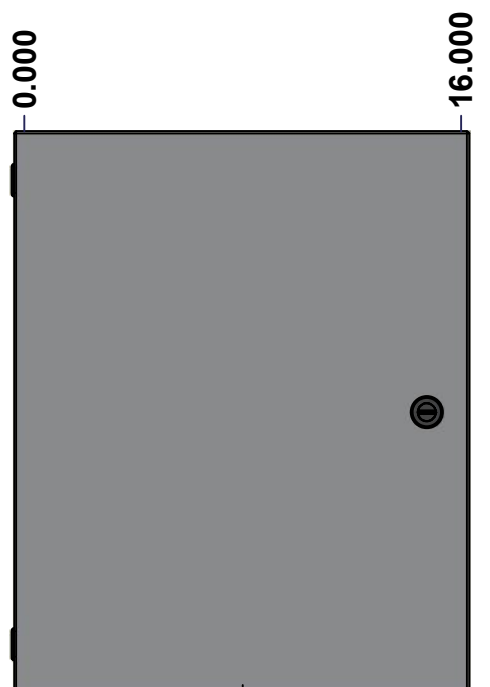

FRONT

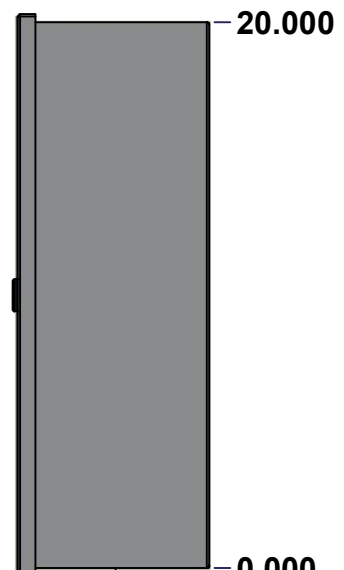

RIGHT

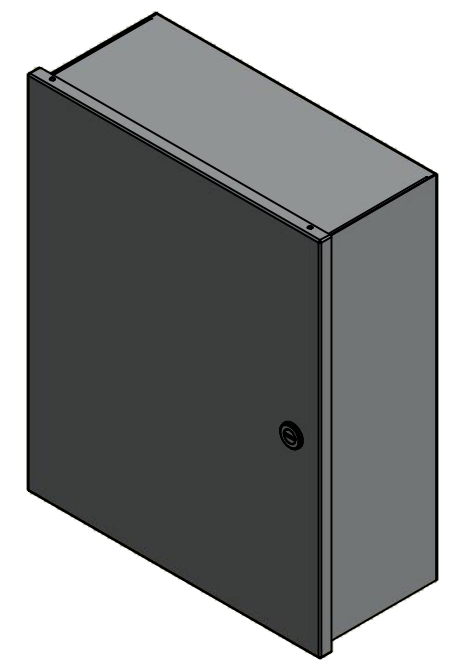

Isometric View

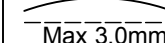
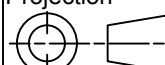

No.	Revisions	Date	By/Par

 Tél: (450) 979-4373 Fax: (450) 979-4626 <a href="http://www.exmweb.com">www.exmweb.com</a>		Flatness Aplatissement  Max 3.0mm Projection 
Customer Client		Date
Drawn By Dessiné Par	BoxCad: BoxCad	Date 24-Dec-13
Material Matière	16 Ga Cold Rolled A1008 CS Type B (1.4mm)	
Color Couleur	Asa-61 Grey	Finish Fini Smooth
Description 1100 20" x 16" x 6.87" Assembly		Detail Rev.
Part Number Numéro Pièce		Rev. 1
SEE BILL OF MATERIAL ON LAST PAGE		0
1100201606		9

This drawing is confidential and must not be reproduced or used without the consent of EXM

Ce dessin est confidentiel et ne doit pas être reproduit ou utilisé sans le consentement de EXM

NOTE	
ITEM	DESCRIPTION
1	NEMA 1 Enclosure
2	C/W Standard ground studs on box and cover
3	W/O Standard door stiffener
4	W/O Inner panel
5	C/W Standard inner panel mounting studs

No.	Revisions	Date	By/Par

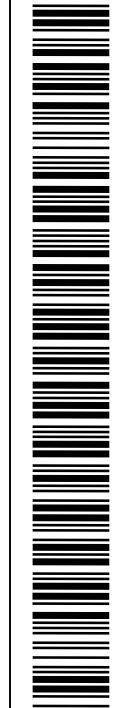
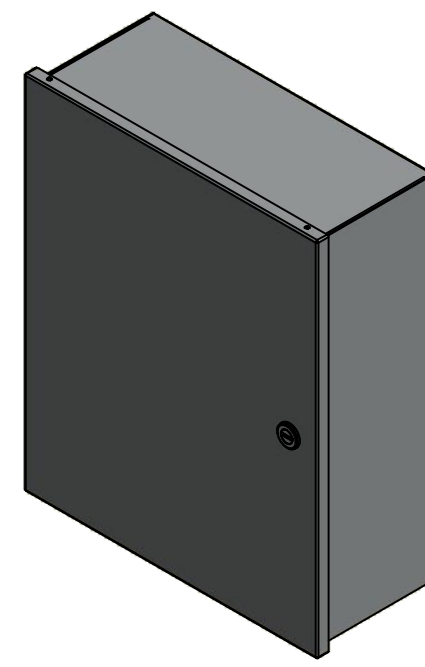

Isometric View



Tél: (450) 979-4373  
 Fax: (450) 979-4626  
[www.exmweb.com](http://www.exmweb.com)

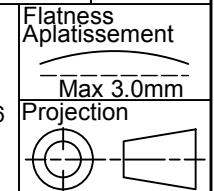

Customer Client	Date
Drawn By / Dessiné Par: BoxCad: BoxCad	Date: 24-Dec-13
Material / Matière: 16 Ga Cold Rolled A1008 CS Type B (1.4mm)	
Color / Couleur: Asa-61 Grey	Finish / Fini: Smooth

PACKING		
ITEM	QTY	DESCRIPTION
Cardboard sleeve	1	Top
Thermal plastic film	1	Use with Packing Tunnel Wrapper Machine
Packaging label	1	White label with product number

Qty	Part Number	Rev	Description
1	1100201606C	0	1100 20" x 16" Cover
1	1100201606B	0	1100 20" x 16" x 6.87" Body
2	STK-Q-08100	1	M5 Nylon Insert Lock Nut

Parts List

Description: 1100 20" x 16" x 6.87" Assembly		Detail Rev.	
Part Number / Numéro Pièce: <b>1100201606</b>		Rev.:	2
		<b>0</b>	9

This drawing is confidential and must not be reproduced or used without the consent of EXM

Ce dessin est confidentiel et ne doit pas être reproduit ou utilisé sans le consentement de EXM



TOP



BACK

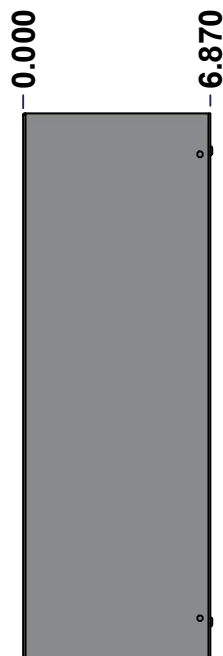

LEFT

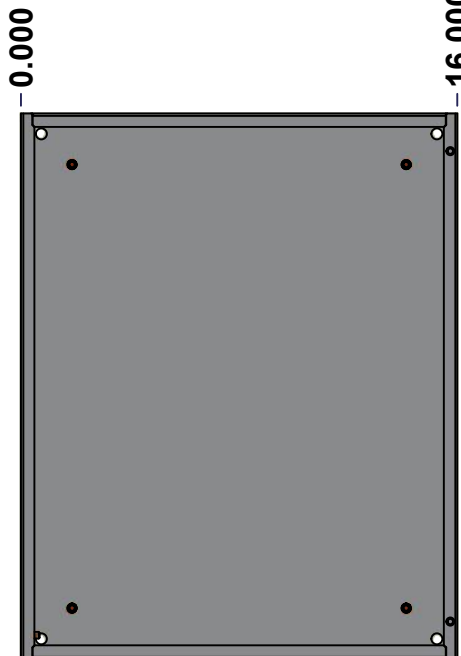

FRONT

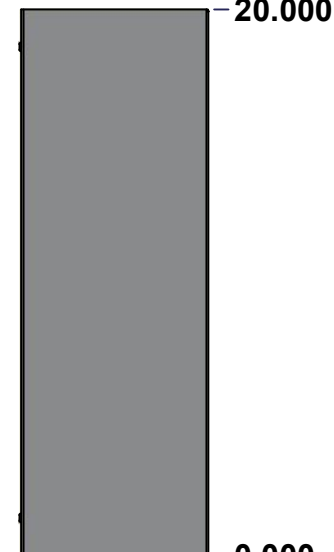

RIGHT



BOTTOM

No.	Revisions	Date	By/Par

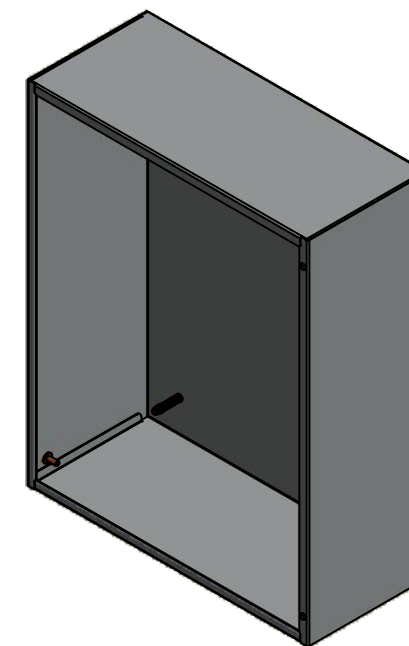

Isometric View



Tél: (450) 979-4373  
 Fax: (450) 979-4626  
[www.exmweb.com](http://www.exmweb.com)

Flatness  
Aplatissement

Max 3.0mm

Projection



Customer Client	Date
Drawn By / Dessiné Par: BoxCad: BoxCad	Date: 24-Dec-13
Material / Matière: 16 Ga Cold Rolled A1008 CS Type B (1.4mm)	
Color / Couleur: Asa-61 Grey	Finish / Fini: Smooth
Description: 1100 20" x 16" x 6.87" Body	Detail Rev.
Part Number / Numéro Pièce: 1100201606B	Rev. 0

SEE BILL OF MATERIAL ON LAST PAGE

3  
9

This drawing is confidential and must not be reproduced or used without the consent of EXM

Ce dessin est confidentiel et ne doit pas être reproduit ou utilisé sans le consentement de EXM

<b>STANDARD FEATURES ARE NOT LISTED IN THIS HOLE TABLE</b>			
<b>HOLE TABLE - LEFT VIEW (CUSTOM FEATURE ONLY)</b>			
CUT-OUT	XDIM	YDIM	DESCRIPTION
1	5.807	0.875	GND STUD M6 x 16mm (Inside)

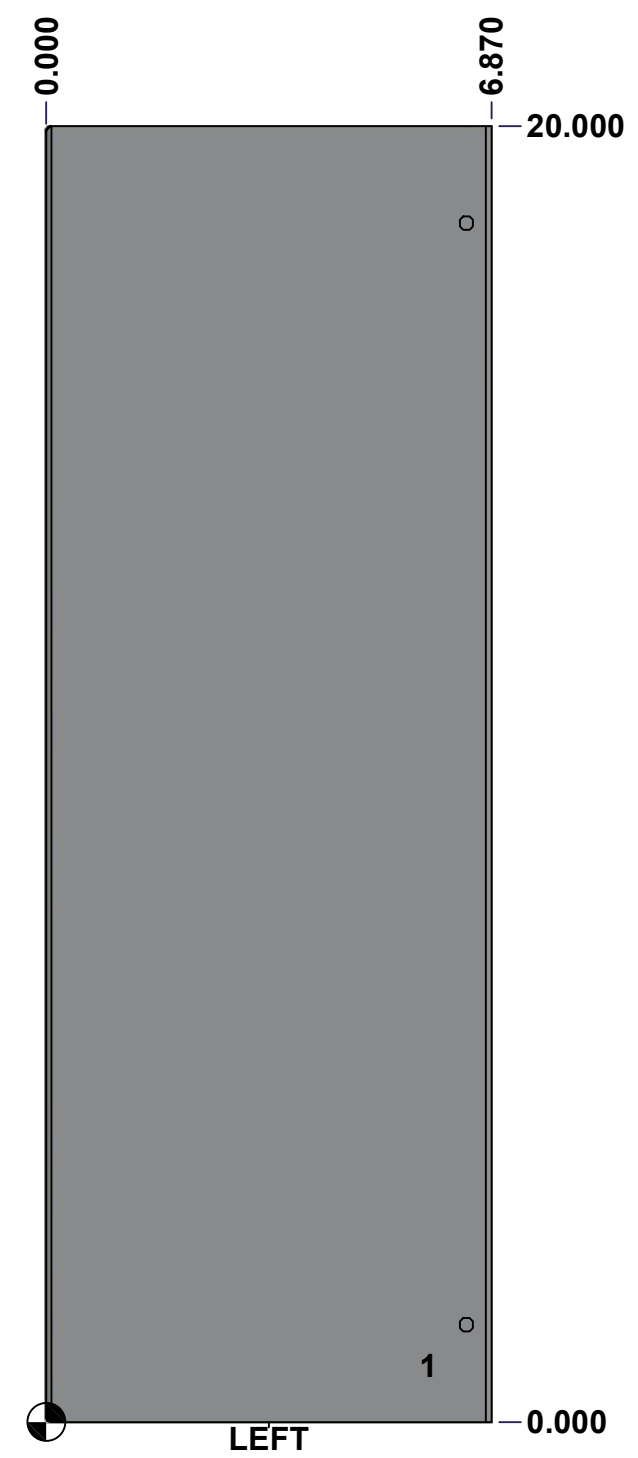

	Description 1100 20" x 16" x 6.87" Body	Status (NULL)
	Part Number Numéro Pièce <b>1100201606B</b>	Rev. 4 <b>0</b> / 9

This drawing is confidential and must not be reproduced or used without the consent of EXM

Ce dessin est confidentiel et ne doit pas être reproduit ou utilisé sans le consentement de EXM

**STANDARD FEATURES ARE NOT LISTED IN THIS HOLE TABLE**

**HOLE TABLE - BACK VIEW (CUSTOM FEATURE ONLY)**

CUT-OUT	XDIM	YDIM	DESCRIPTION
1	1.875	18.125	IP STUD M8 x 35mm (Inside)
2	1.875	1.875	IP STUD M8 x 35mm (Inside)
3	14.125	1.875	IP STUD M8 x 35mm (Inside)
4	14.125	18.125	IP STUD M8 x 35mm (Inside)
-----			
5	15.250	0.750	RND Ø0.390
6	15.250	19.250	RND Ø0.390
7	0.750	19.250	RND Ø0.390
8	0.750	0.750	RND Ø0.390

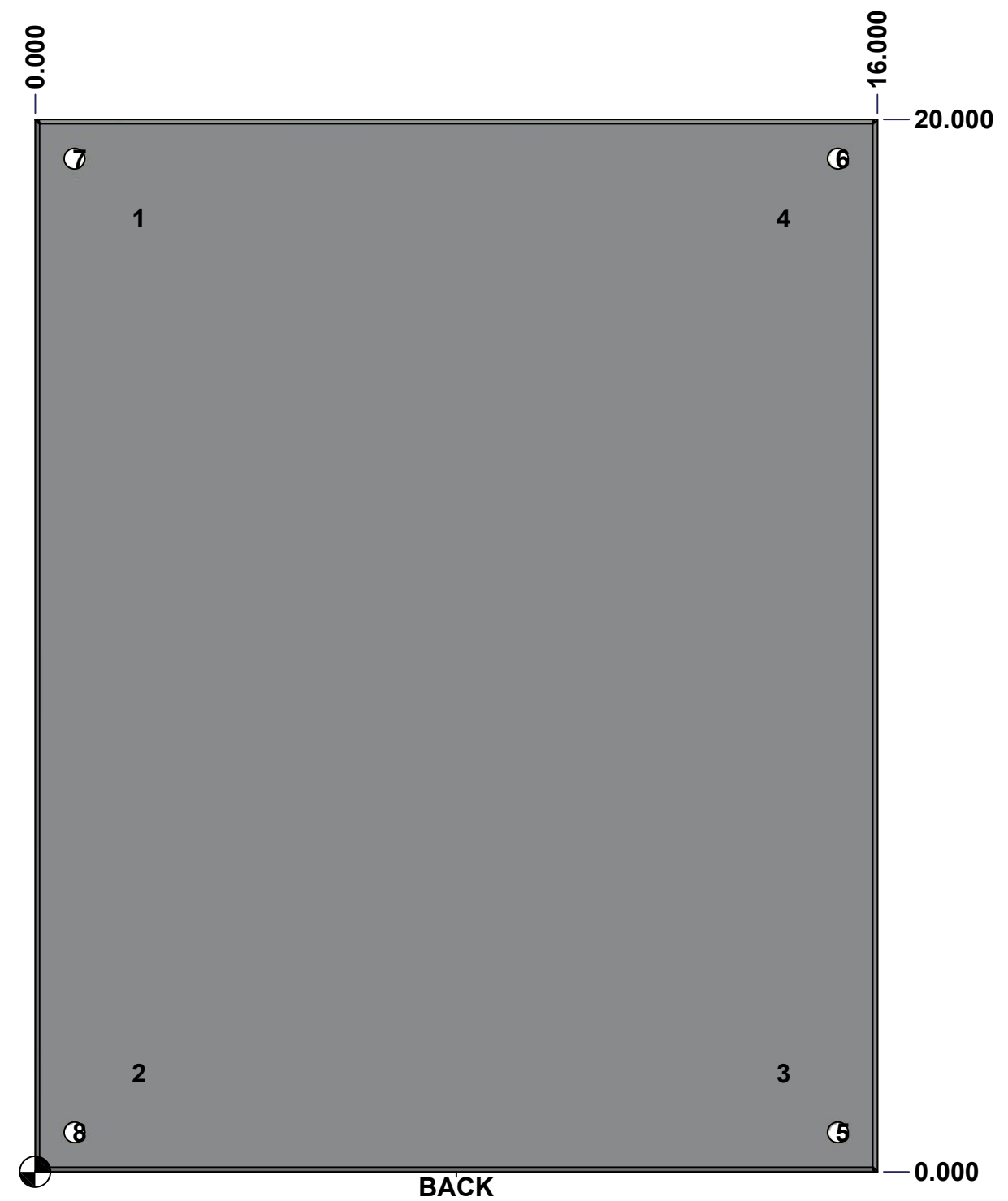

	Description	Status
	1100 20" x 16" x 6.87" Body	(NULL)
	Part Number Numéro Pièce	Rev.
	<b>1100201606B</b>	<b>0</b> / 5 / 9

This drawing is confidential and must not be reproduced or used without the consent of EXM

Ce dessin est confidentiel et ne doit pas être reproduit ou utilisé sans le consentement de EXM

No.	Revisions	Date	By/Par

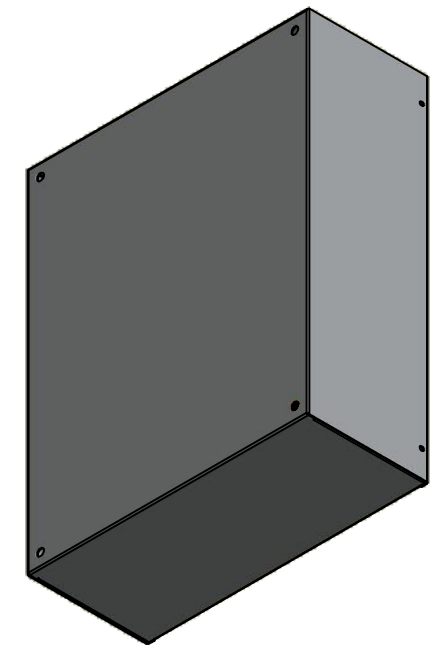

Isometric View

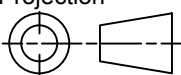

 Tél: (450) 979-4373 Fax: (450) 979-4626 <a href="http://www.exmweb.com">www.exmweb.com</a>		Flatness Aplatissement Max 3.0mm Projection 
Customer Client	Date	
Drawn By Dessiné Par	BoxCad: BoxCad	Date 24-Dec-13
Material Matière	16 Ga Cold Rolled A1008 CS Type B (1.4mm)	
Color Couleur	Asa-61 Grey	Finish Fini Smooth
Description		Detail Rev.
1100 20" x 16" x 6.87" Body		
Part Number Numéro Pièce	Rev.	6
<b>1100201606B</b>	<b>0</b>	9

Qty	Part Number	Rev	Description
1	STK-Q-16080	0	Ground Stud M6 x 16mm
1	1100201606B-P	0	1100 20" x 16" x 6.87" Body Part
1	STK-P-02400S	0	Powder Paint (Asa-61 Grey / Smooth)
2	STK-Q-77110	1	5412 ES Cover Plastic Plug
4	STK-Q-16005	1	Stud M8 x 35 (No Paint Cap Required)
Parts List			

This drawing is confidential and must not be reproduced or used without the consent of EXM

Ce dessin est confidentiel et ne doit pas être reproduit ou utilisé sans le consentement de EXM



TOP

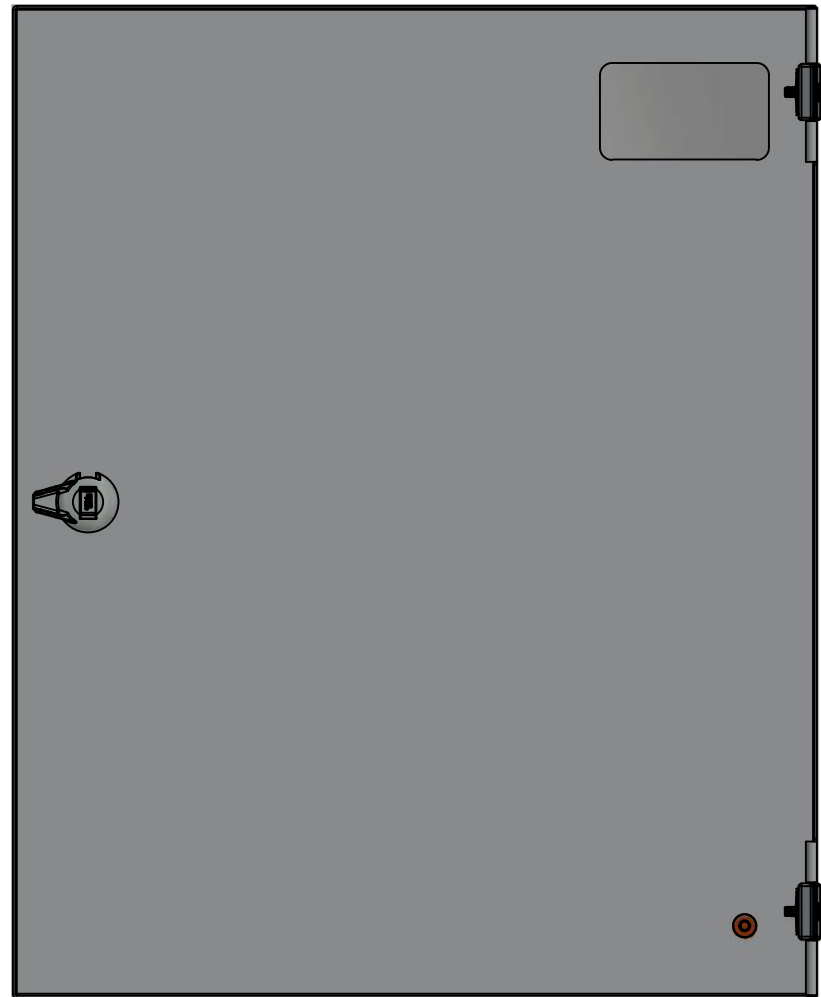

BACK

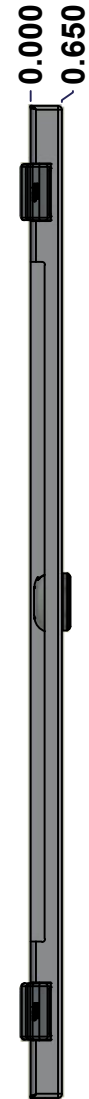

LEFT



FRONT

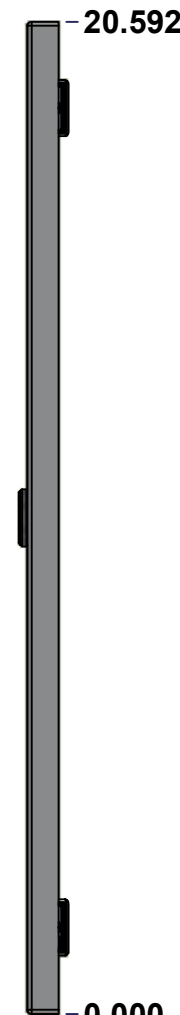

RIGHT



BOTTOM

No.	Revisions	Date	By/Par

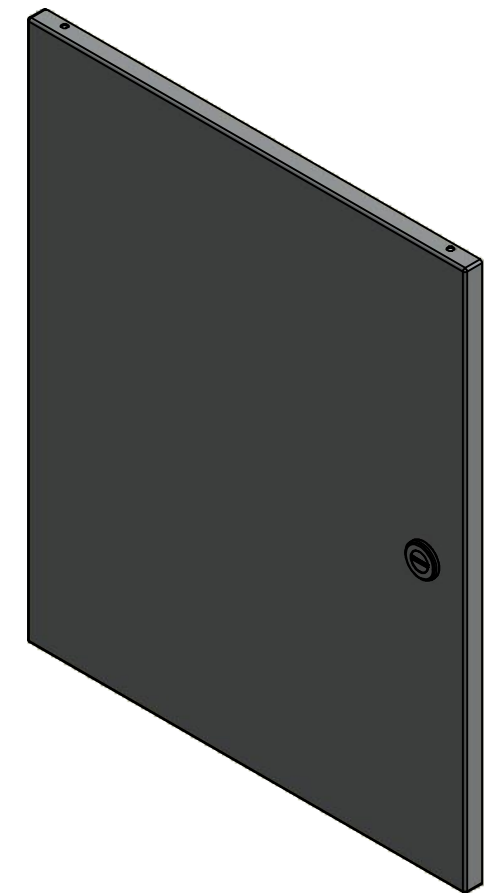

Isometric View



Tél: (450) 979-4373  
 Fax: (450) 979-4626  
[www.exmweb.com](http://www.exmweb.com)

Flatness  
 Aplatissement  
 Max 3.0mm  
 Projection

Customer Client	Date
Drawn By Dessiné Par BoxCad: BoxCad	Date 24-Dec-13
Material Matière 16 Ga Cold Rolled A1008 CS Type B (1.4mm)	
Color Couleur Asa-61 Grey	Finish Fini Smooth
Description 1100 20" x 16" Cover	Detail Rev.
Part Number Numéro Pièce <b>1100201606C</b>	Rev. 7 <b>0</b>

SEE BILL OF MATERIAL ON LAST PAGE

This drawing is confidential and must not be reproduced or used without the consent of EXM

Ce dessin est confidentiel et ne doit pas être reproduit ou utilisé sans le consentement de EXM

STANDARD FEATURES ARE NOT LISTED IN THIS HOLE TABLE			
HOLE TABLE - FRONT VIEW (CUSTOM FEATURE ONLY)			
CUT-OUT	XDIM	YDIM	DESCRIPTION
1	1.500	1.500	GND STUD M6 x 16mm (Inside)
2	15.125	10.296	LOCK 880 SCQ1-SLZ @ 0.0°

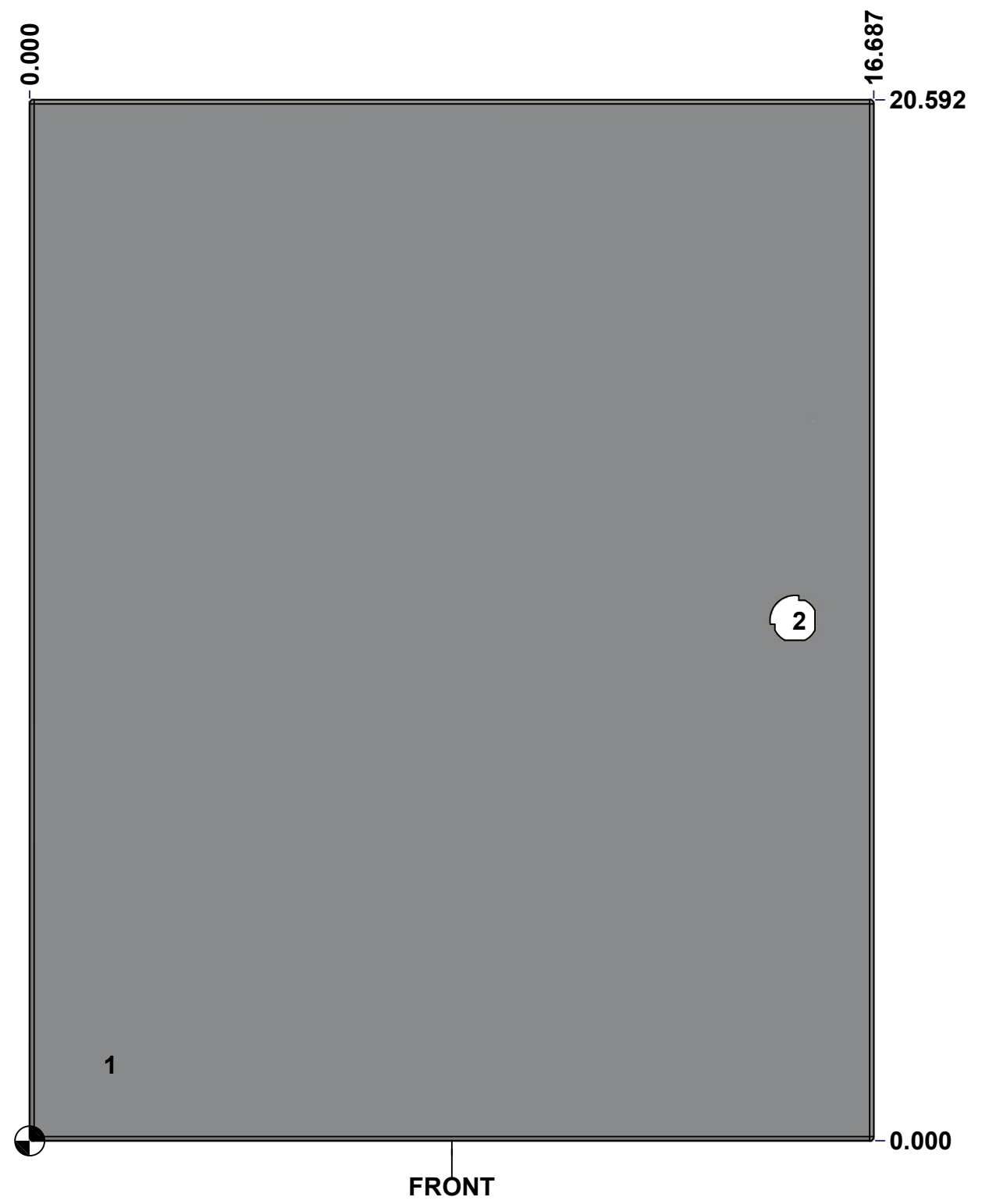

	Description	Status	
	1100 20" x 16" x 6.87" Cover	(NULL)	
	Part Number Numéro Pièce	Rev.	
	<b>1100201606C</b>	<b>0</b>	8 9



This drawing is confidential and must not be reproduced or used without the consent of EXM

Ce dessin est confidentiel et ne doit pas être reproduit ou utilisé sans le consentement de EXM

No.	Revisions	Date	By/Par

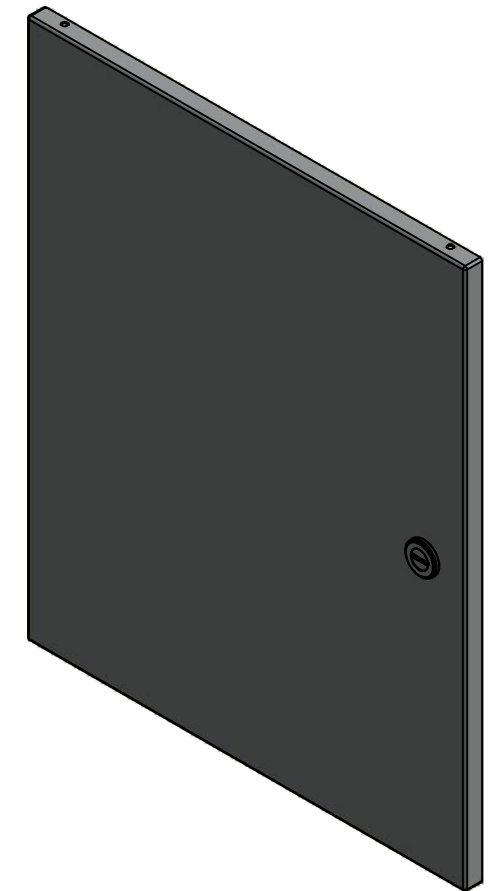

Isometric View

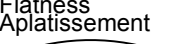
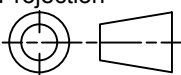

 Tél: (450) 979-4373 Fax: (450) 979-4626 <a href="http://www.exmweb.com">www.exmweb.com</a>		Flatness Aplatissement  Max 3.0mm Projection 
Customer Client	Date	
Drawn By Dessiné Par	BoxCad: BoxCad	Date 24-Dec-13
Material Matière	16 Ga Cold Rolled A1008 CS Type B (1.4mm)	
Color Couleur	Asa-61 Grey	Finish Fini Smooth
Description		Detail Rev.
1100 20" x 16" Cover		
Part Number Numéro Pièce	Rev.	9
<b>1100201606C</b>	<b>0</b>	<b>9</b>

Qty	Part Number	Rev	Description
1	880 SCQ1-SLZ	0	1100 1/4 Turn Lock
1	STK-Q-16080	0	Ground Stud M6 x 16mm
1	STK-S-00100	0	3.5" x 2" Silver Milar Flexcon Sticker
1	STK-P-02400S	0	Powder Paint (Asa-61 Grey / Smooth)
1	1100201606C-P	0	1100 20" x 16" x 6.87" Cover Part
2	STK-A-33033	4	5412 ESMCH Hinge
Parts List			