

This drawing is confidential and must not be reproduced or used without the consent of EXM

Ce dessin est confidentiel et ne doit pas être reproduit ou utilisé sans le consentement de EXM

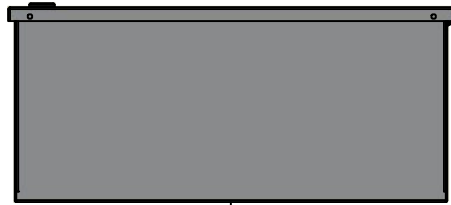

TOP

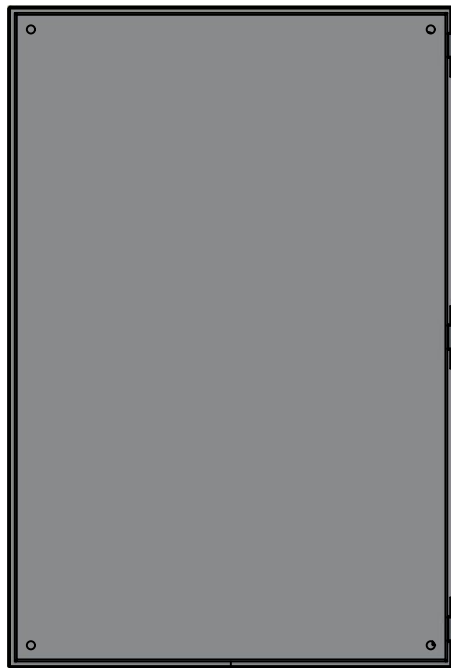

BACK

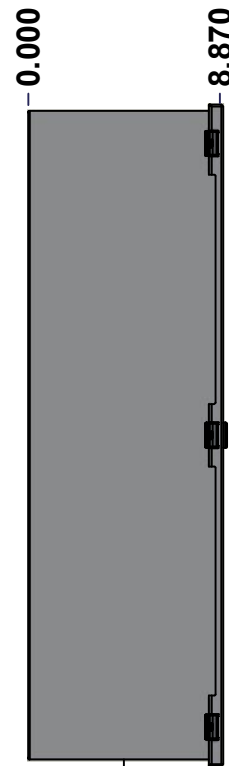

LEFT

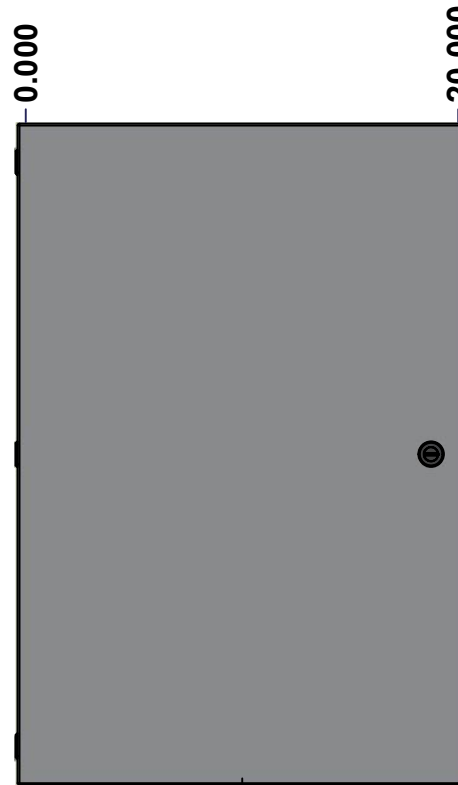

FRONT

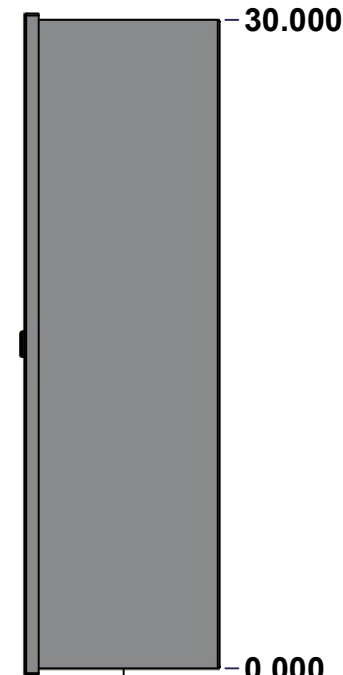

RIGHT



BOTTOM

| No. | Revisions | Date | By/Par |
|-----|-----------|------|--------|
|     |           |      |        |
|     |           |      |        |
|     |           |      |        |
|     |           |      |        |

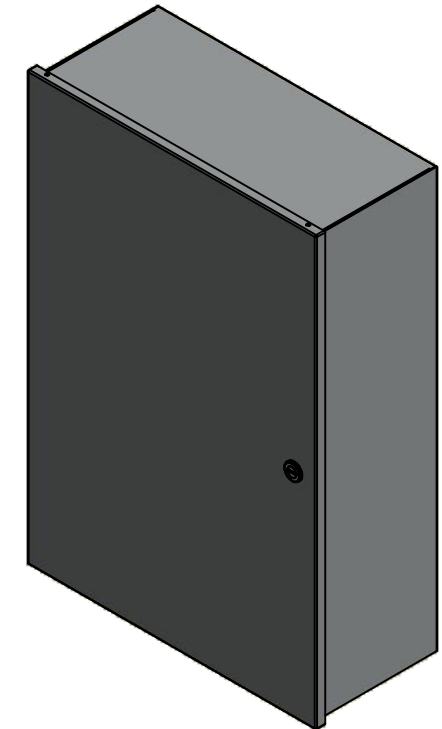

Isometric View



Tél: (450) 979-4373  
 Fax: (450) 979-4626  
[www.exmweb.com](http://www.exmweb.com)

Flatness  
Aplatissement  
Max 3.0mm  
Projection

|   |                       |
|---|-----------------------|
| Customer<br>Client  | Date                  |
| Drawn By<br>Dessiné Par BoxCad: BoxCad                        | Date 12/24/2013       |
| Material<br>Matière 14 Ga Cold Rolled A1008 CS Type B (1.7mm) |                       |
| Color<br>Couleur Asa-61 Grey                                  | Finish<br>Fini Smooth |
| Description<br>1100 30" x 20" x 8.87" Assembly                | Detail Rev.           |
| Part Number<br>Numéro Pièce 1100302008                        | Rev. 1<br>0           |

SEE BILL OF MATERIAL ON LAST PAGE

This drawing is confidential and must not be reproduced or used without the consent of EXM

Ce dessin est confidentiel et ne doit pas être reproduit ou utilisé sans le consentement de EXM

| NOTE |  |
|------|--|
| ITEM | DESCRIPTION                                |
| 1    | NEMA 1 Enclosure                           |
| 2    | C/W Standard ground studs on box and cover |
| 3    | W/O Standard door stiffener                |
| 4    | W/O Inner panel                            |
| 5    | C/W Standard inner panel mounting studs    |

| No. | Revisions | Date | By/Par |
|-----|-----------|------|--------|
|     |           |      |        |
|     |           |      |        |
|     |           |      |        |
|     |           |      |        |
|     |           |      |        |
|     |           |      |        |

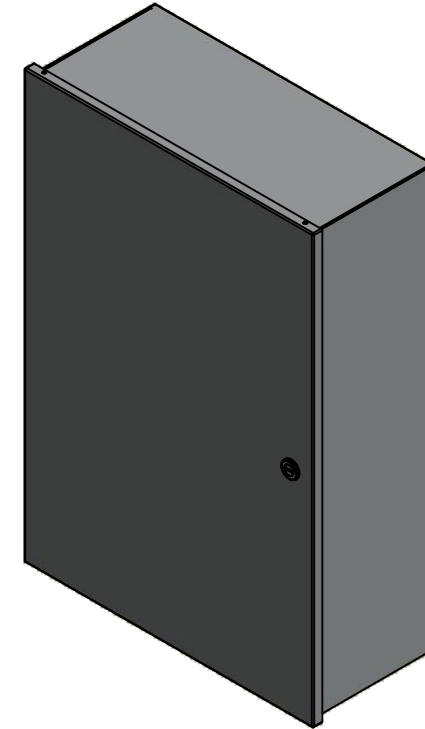

Isometric View



Tél: (450) 979-4373  
 Fax: (450) 979-4626  
[www.exmweb.com](http://www.exmweb.com)



|   |                       |
|---|-----------------------|
| Customer Client   | Date                  |
| Drawn By / Dessiné Par: BoxCad: BoxCad                        | Date: 12/24/2013      |
| Material / Matière: 14 Ga Cold Rolled A1008 CS Type B (1.7mm) |                       |
| Color / Couleur: Asa-61 Grey                                  | Finish / Fini: Smooth |

| PACKING              |     |   |
|----------------------|-----|---|
| ITEM                 | QTY | DESCRIPTION                             |
| Cardboard sleeve     | 1   | Top                                     |
| Thermal plastic film | 1   | Use with Packing Tunnel Wrapper Machine |
| Packaging label      | 1   | White label with product number         |

| Qty | Part Number | Rev | Description                 |
|-----|-------------|-----|-----------------------------|
| 1   | 1100302008C | 0   | 1100 30" x 20" Cover        |
| 1   | 1100302008B | 0   | 1100 30" x 20" x 8.87" Body |
| 3   | STK-Q-08100 | 1   | M5 Nylon Insert Lock Nut    |

Parts List

|   |  |             |   |
|---|--|-------------|---|
| Description: 1100 30" x 20" x 8.87" Assembly  |  | Detail Rev. |   |
| Part Number / Numéro Pièce: <b>1100302008</b> |  | Rev.:       | 2 |
|   |  | <b>0</b>    | 9 |

This drawing is confidential and must not be reproduced or used without the consent of EXM

Ce dessin est confidentiel et ne doit pas être reproduit ou utilisé sans le consentement de EXM



TOP



BACK

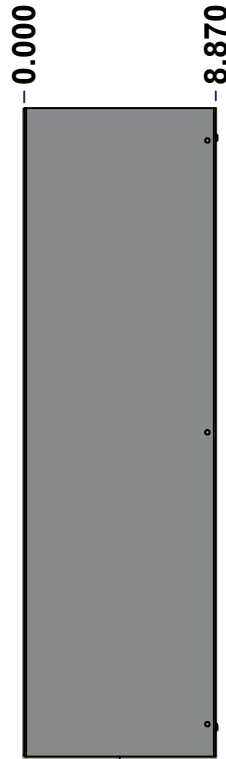

LEFT

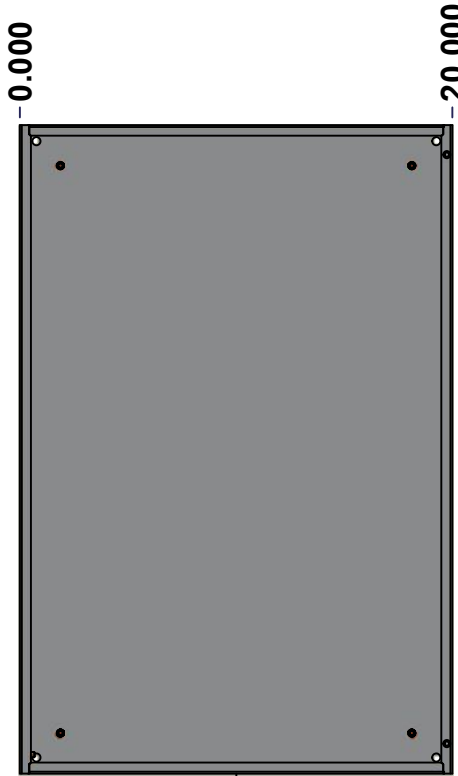

FRONT

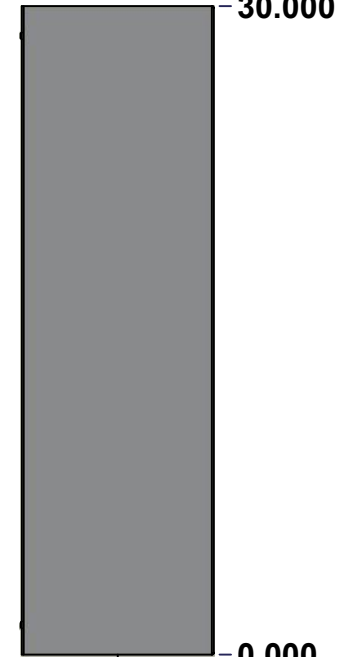

RIGHT



BOTTOM

| No. | Revisions | Date | By/Par |
|-----|-----------|------|--------|
|     |           |      |        |
|     |           |      |        |
|     |           |      |        |
|     |           |      |        |
|     |           |      |        |

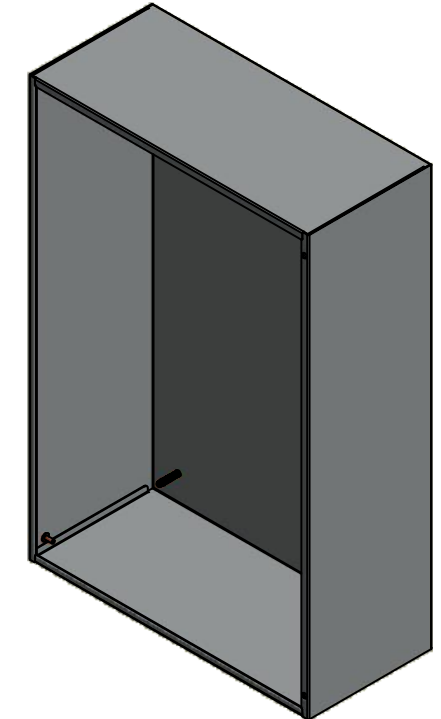

Isometric View

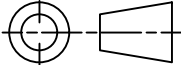

|  |   |   |
|--|---|---|
|  Tél: (450) 979-4373<br>Fax: (450) 979-4626<br><a href="http://www.exmweb.com">www.exmweb.com</a> |   | Flatness<br>Aplatissement<br>Max 3.0mm<br>Projection<br> |
| Customer Client  | Date                                      |   |
| Drawn By<br>Dessiné Par  | BoxCad: BoxCad                            | Date 12/24/2013   |
| Material<br>Matière  | 14 Ga Cold Rolled A1008 CS Type B (1.7mm) |   |
| Color<br>Couleur   | Asa-61 Grey                               | Finish<br>Fini Smooth   |
| Description<br>1100 30" x 20" x 8.87" Body   |   | Detail Rev.   |
| Part Number<br>Numéro Pièce  | Rev. 0                                    | 3<br>9  |

SEE BILL OF MATERIAL ON LAST PAGE

**1100302008B**

This drawing is confidential and must not be reproduced or used without the consent of EXM

Ce dessin est confidentiel et ne doit pas être reproduit ou utilisé sans le consentement de EXM

| <b>STANDARD FEATURES ARE NOT LISTED IN THIS HOLE TABLE</b> |       |       |                             |
|--|-------|-------|-----------------------------|
| <b>HOLE TABLE - LEFT VIEW (CUSTOM FEATURE ONLY)</b>        |       |       |                             |
| CUT-OUT  | XDIM  | YDIM  | DESCRIPTION                 |
| 1  | 7.807 | 0.875 | GND STUD M6 x 16mm (Inside) |

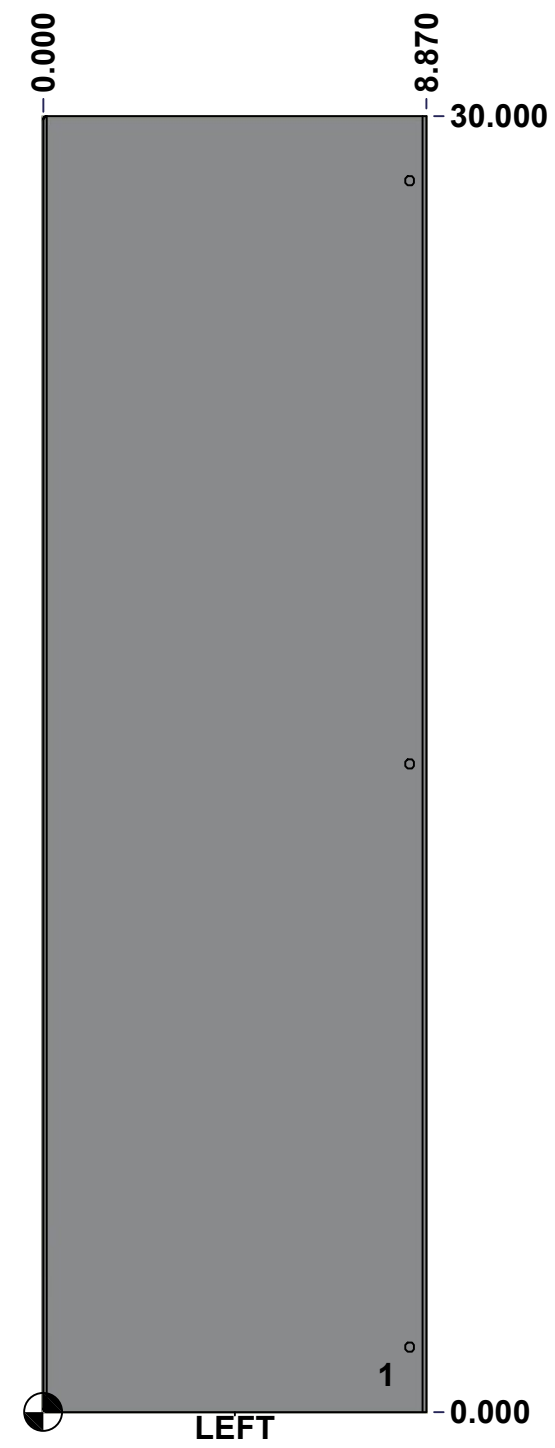

|  |   |                        |
|--|---|------------------------|
|  | Description<br>1100 30" x 20" x 8.87" Body        | Status<br>(NULL)       |
|  | Part Number<br>Numéro Pièce<br><b>1100302008B</b> | Rev. 4<br><b>0</b> / 9 |

This drawing is confidential and must not be reproduced or used without the consent of EXM

Ce dessin est confidentiel et ne doit pas être reproduit ou utilisé sans le consentement de EXM

| STANDARD FEATURES ARE NOT LISTED IN THIS HOLE TABLE |        |        |                            |
|---|--------|--------|----------------------------|
| HOLE TABLE - BACK VIEW (CUSTOM FEATURE ONLY)        |        |        |                            |
| CUT-OUT   | XDIM   | YDIM   | DESCRIPTION                |
| 1   | 1.875  | 28.125 | IP STUD M8 x 35mm (Inside) |
| 2   | 1.875  | 1.875  | IP STUD M8 x 35mm (Inside) |
| 3   | 18.125 | 1.875  | IP STUD M8 x 35mm (Inside) |
| 4   | 18.125 | 28.125 | IP STUD M8 x 35mm (Inside) |
| -----   |        |        |                            |
| 5   | 19.250 | 0.750  | RND Ø0.390                 |
| 6   | 19.250 | 29.250 | RND Ø0.390                 |
| 7   | 0.750  | 29.250 | RND Ø0.390                 |
| 8   | 0.750  | 0.750  | RND Ø0.390                 |

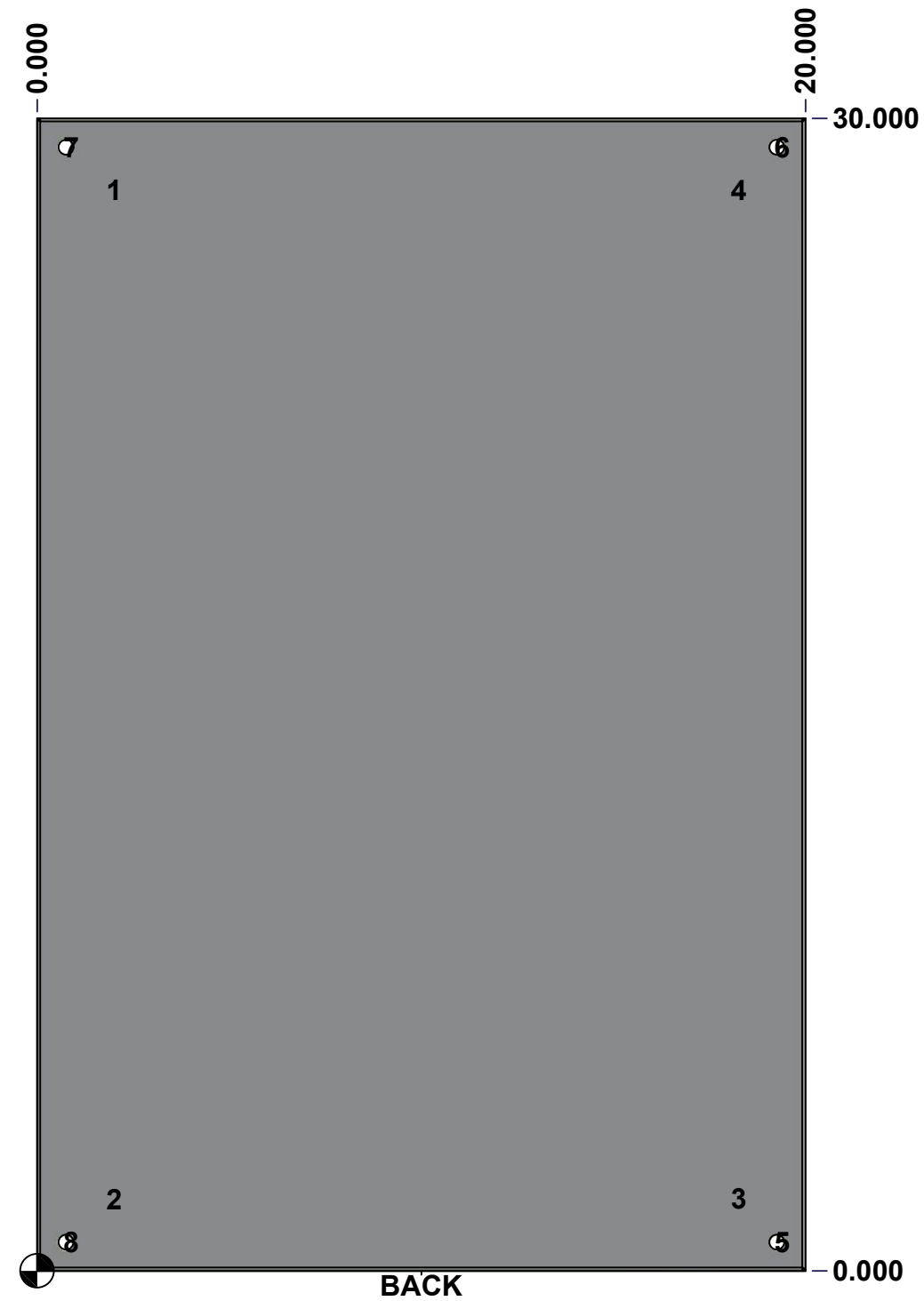

|  |   |                        |
|--|---|------------------------|
|  | Description<br>1100 30" x 20" x 8.87" Body        | Status<br>(NULL)       |
|  | Part Number<br>Numéro Pièce<br><b>1100302008B</b> | Rev. 5<br><b>0</b> / 9 |

This drawing is confidential and must not be reproduced or used without the consent of EXM

Ce dessin est confidentiel et ne doit pas être reproduit ou utilisé sans le consentement de EXM

| No. | Revisions | Date | By/Par |
|-----|-----------|------|--------|
|     |           |      |        |
|     |           |      |        |
|     |           |      |        |
|     |           |      |        |
|     |           |      |        |

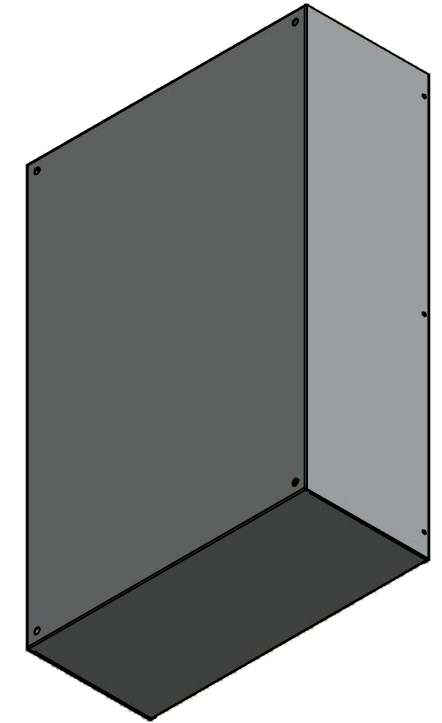

Isometric View

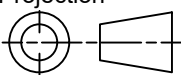

|  |   |   |
|--|---|---|
|  Tél: (450) 979-4373<br>Fax: (450) 979-4626<br><a href="http://www.exmweb.com">www.exmweb.com</a> | Flatness<br>Aplatissement                 | Max 3.0mm   |
|  | Projection                                |  |
| Customer<br>Client   | Date                                      |   |
| Drawn By<br>Dessiné Par  | BoxCad: BoxCad                            | Date 12/24/2013   |
| Material<br>Matière  | 14 Ga Cold Rolled A1008 CS Type B (1.7mm) |   |
| Color<br>Couleur   | Asa-61 Grey                               | Finish<br>Fini Smooth   |
| Description  | Detail Rev.                               |   |
| 1100 30" x 20" x 8.87" Body  |   |   |
| Part Number<br>Numéro Pièce  | Rev.                                      | 6   |
| <b>1100302008B</b>   | <b>0</b>                                  | 9   |

| Qty        | Part Number   | Rev | Description                          |
|------------|---------------|-----|--------------------------------------|
| 1          | STK-Q-16080   | 0   | Ground Stud M6 x 16mm                |
| 1          | 1100302008B-P | 0   | 1100 30" x 20" x 8.87" Body Part     |
| 1          | STK-P-02400S  | 0   | Powder Paint (Asa-61 Grey / Smooth)  |
| 2          | STK-Q-77110   | 1   | 5412 ES Cover Plastic Plug           |
| 4          | STK-Q-16005   | 1   | Stud M8 x 35 (No Paint Cap Required) |
| Parts List |               |     |                                      |

This drawing is confidential and must not be reproduced or used without the consent of EXM

Ce dessin est confidentiel et ne doit pas être reproduit ou utilisé sans le consentement de EXM



TOP

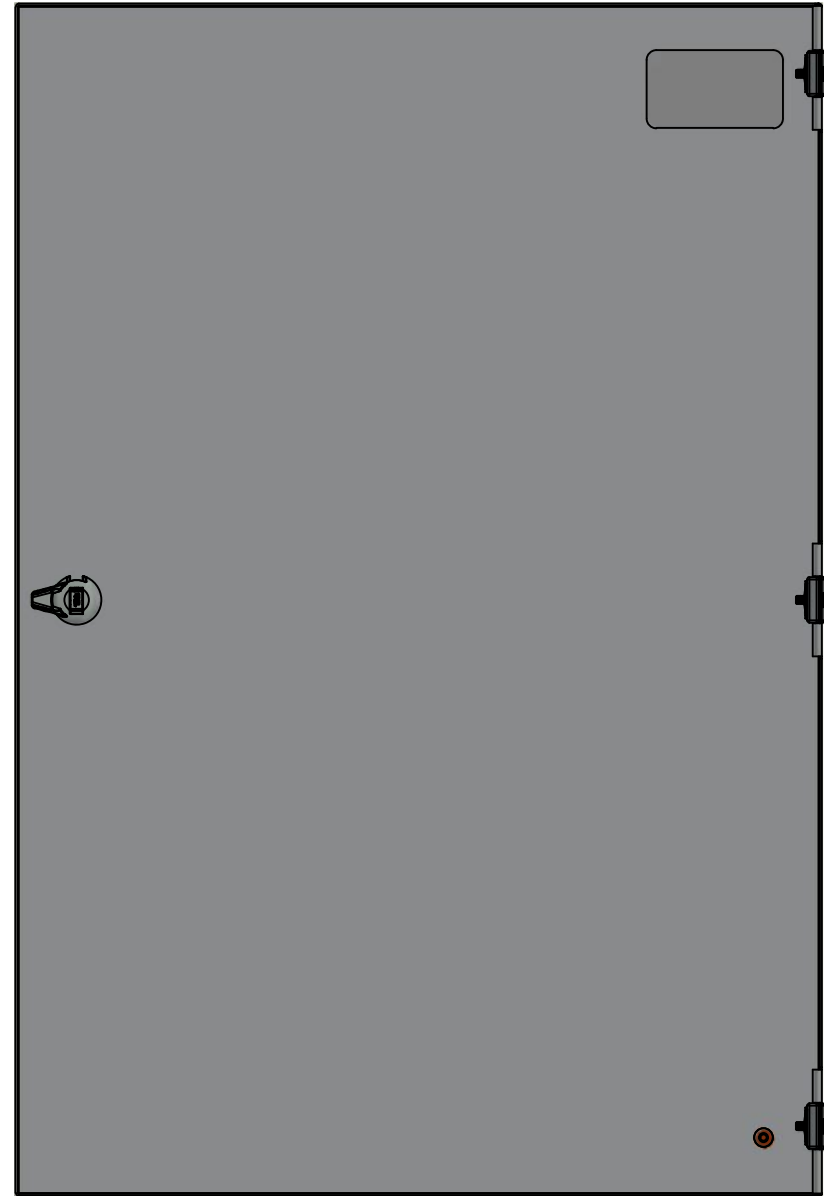

BACK

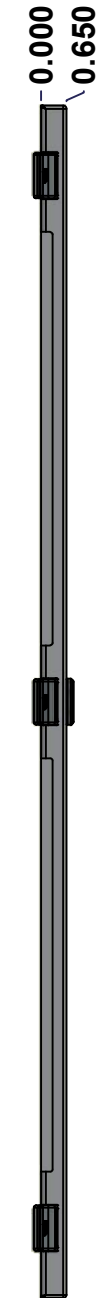

LEFT

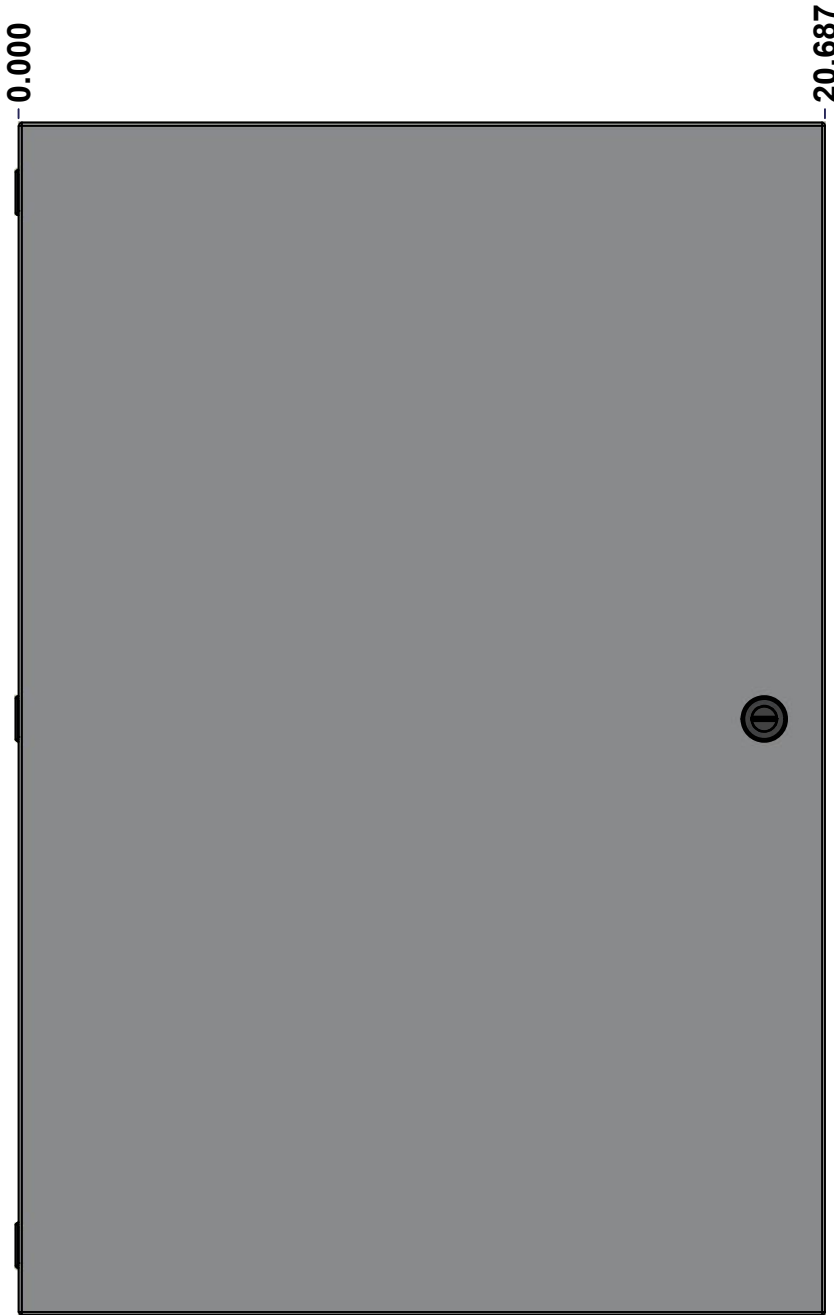

FRONT

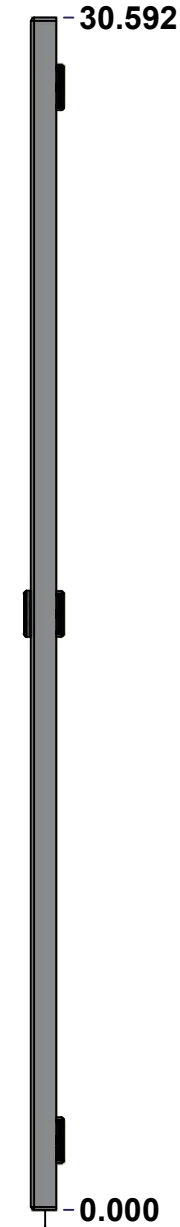

RIGHT



BOTTOM

| No. | Revisions | Date | By/Par |
|-----|-----------|------|--------|
|     |           |      |        |
|     |           |      |        |
|     |           |      |        |
|     |           |      |        |



Isometric View

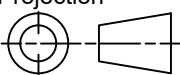

|  |   |   |
|--|---|---|
|  Tél: (450) 979-4373<br>Fax: (450) 979-4626<br><a href="http://www.exmweb.com">www.exmweb.com</a> | Flatness<br>Aplatissement                 | Max 3.0mm   |
|  | Projection                                |  |
| Customer<br>Client   | Date                                      |   |
| Drawn By<br>Dessiné Par  | BoxCad: BoxCad                            | Date 12/24/2013   |
| Material<br>Matière  | 16 Ga Cold Rolled A1008 CS Type B (1.4mm) |   |
| Color<br>Couleur   | Asa-61 Grey                               | Finish<br>Fini Smooth   |
| Description  | Detail Rev.                               |   |
| Part Number<br>Numéro Pièce  | 1100302008C                               | Rev. 7<br>0 9   |

SEE BILL OF MATERIAL ON LAST PAGE

This drawing is confidential and must not be reproduced or used without the consent of EXM

Ce dessin est confidentiel et ne doit pas être reproduit ou utilisé sans le consentement de EXM

| STANDARD FEATURES ARE NOT LISTED IN THIS HOLE TABLE |        |        |                             |
|---|--------|--------|-----------------------------|
| HOLE TABLE - FRONT VIEW (CUSTOM FEATURE ONLY)       |        |        |                             |
| CUT-OUT   | XDIM   | YDIM   | DESCRIPTION                 |
| 1   | 1.500  | 1.500  | GND STUD M6 x 16mm (Inside) |
| 2   | 19.125 | 15.296 | LOCK 880 SCQ1-SLZ @ 0.0°    |

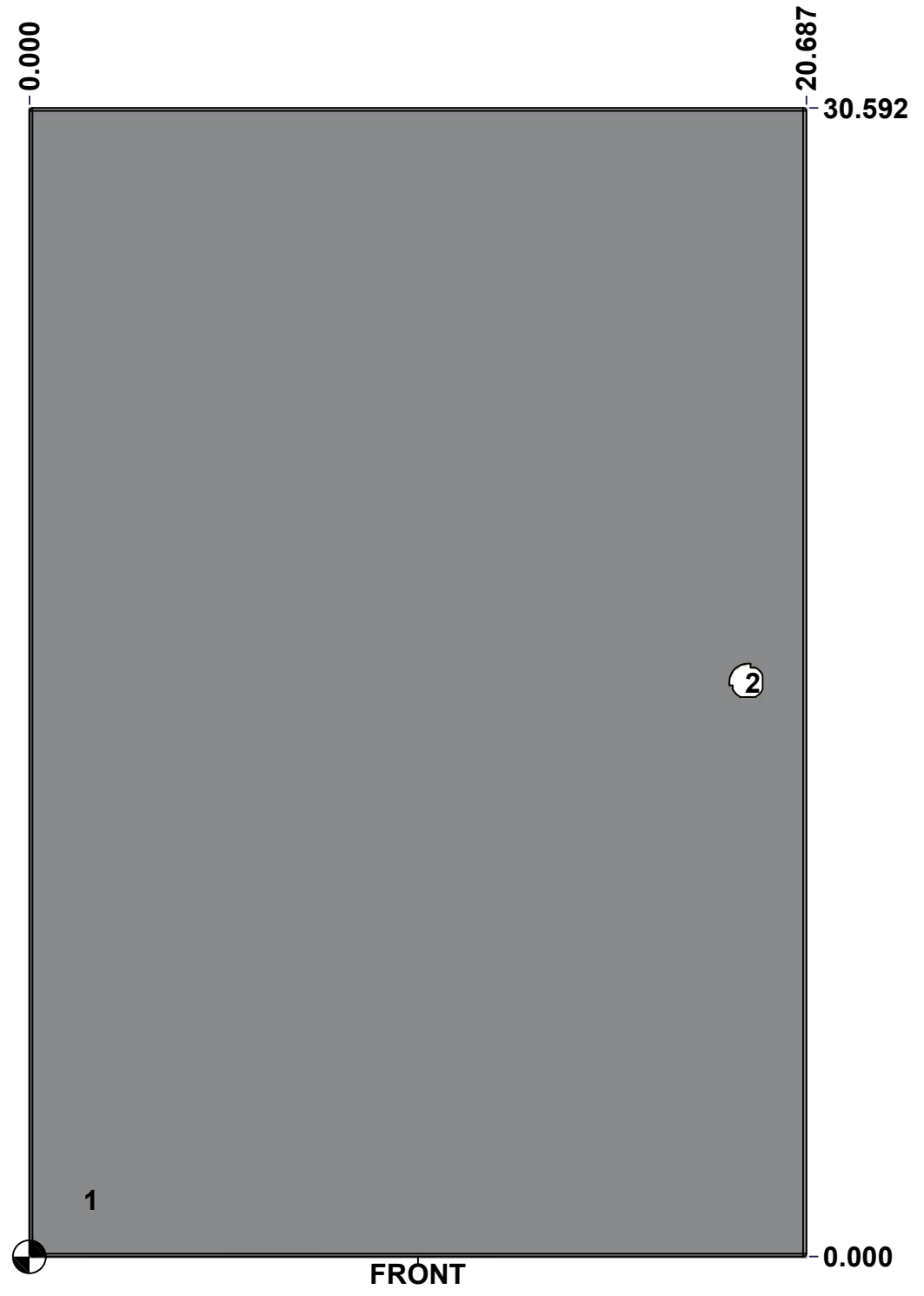

|  |                              |          |       |
|--|------------------------------|----------|-------|
|  | Description                  | Status   |       |
|  | 1100 30" x 20" x 8.87" Cover | (NULL)   |       |
|  | Part Number<br>Numéro Pièce  | Rev.     |       |
|  | <b>1100302008C</b>           | <b>0</b> | 8 / 9 |



This drawing is confidential and must not be reproduced or used without the consent of EXM

Ce dessin est confidentiel et ne doit pas être reproduit ou utilisé sans le consentement de EXM

| No. | Revisions | Date | By/Par |
|-----|-----------|------|--------|
|     |           |      |        |
|     |           |      |        |
|     |           |      |        |
|     |           |      |        |
|     |           |      |        |



Isometric View

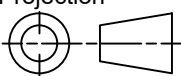

|  |   |   |
|--|---|---|
|  Tél: (450) 979-4373<br>Fax: (450) 979-4626<br><a href="http://www.exmweb.com">www.exmweb.com</a> | Flatness<br>Aplatissement                 | Max 3.0mm   |
|  | Projection                                |  |
| Customer Client  | Date                                      |   |
| Drawn By<br>Dessiné Par  | BoxCad: BoxCad                            | Date 12/24/2013   |
| Material<br>Matière  | 16 Ga Cold Rolled A1008 CS Type B (1.4mm) |   |
| Color<br>Couleur   | Asa-61 Grey                               | Finish<br>Fini Smooth   |
| Description  | Detail Rev.                               |   |
| 1100 30" x 20" Cover   |   |   |
| Part Number<br>Numéro Pièce  | Rev.                                      | 9   |
| <b>1100302008C</b>   | <b>0</b>                                  | <b>9</b>  |

| Qty        | Part Number   | Rev | Description                            |
|------------|---------------|-----|--|
| 1          | 880 SCQ1-SLZ  | 0   | 1100 1/4 Turn Lock                     |
| 1          | STK-Q-16080   | 0   | Ground Stud M6 x 16mm                  |
| 1          | STK-S-00100   | 0   | 3.5" x 2" Silver Milar Flexcon Sticker |
| 1          | STK-P-02400S  | 0   | Powder Paint (Asa-61 Grey / Smooth)    |
| 1          | 1100302008C-P | 0   | 1100 30" x 20" x 8.87" Cover Part      |
| 3          | STK-A-33033   | 4   | 5412 ESMCH Hinge                       |
| Parts List |               |     |  |