

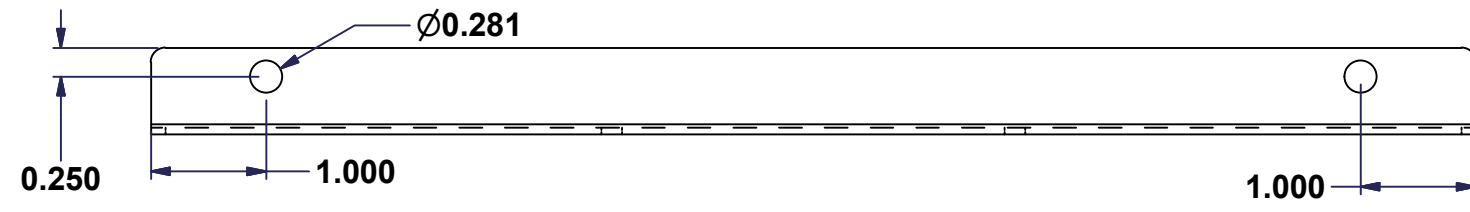

This drawing is confidential and must not be reproduced or used without the consent of EXM

All knockouts are actual size / Les disques défonçables sont grandeur réel
 All dimensions are before paint / Toutes les dimensions sont avant peinture

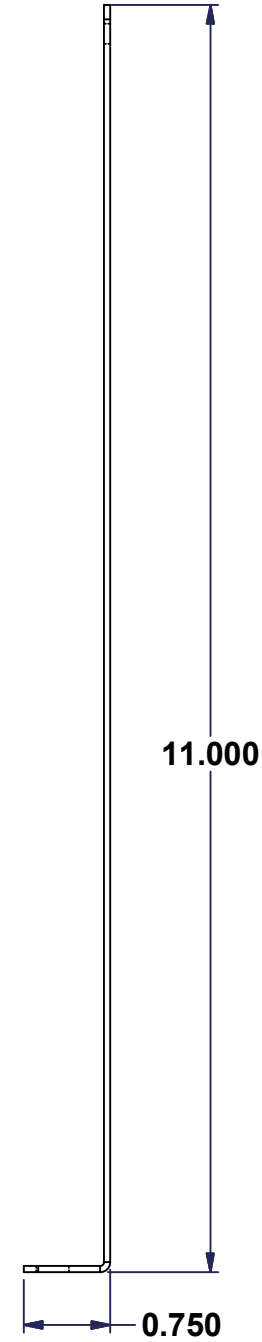
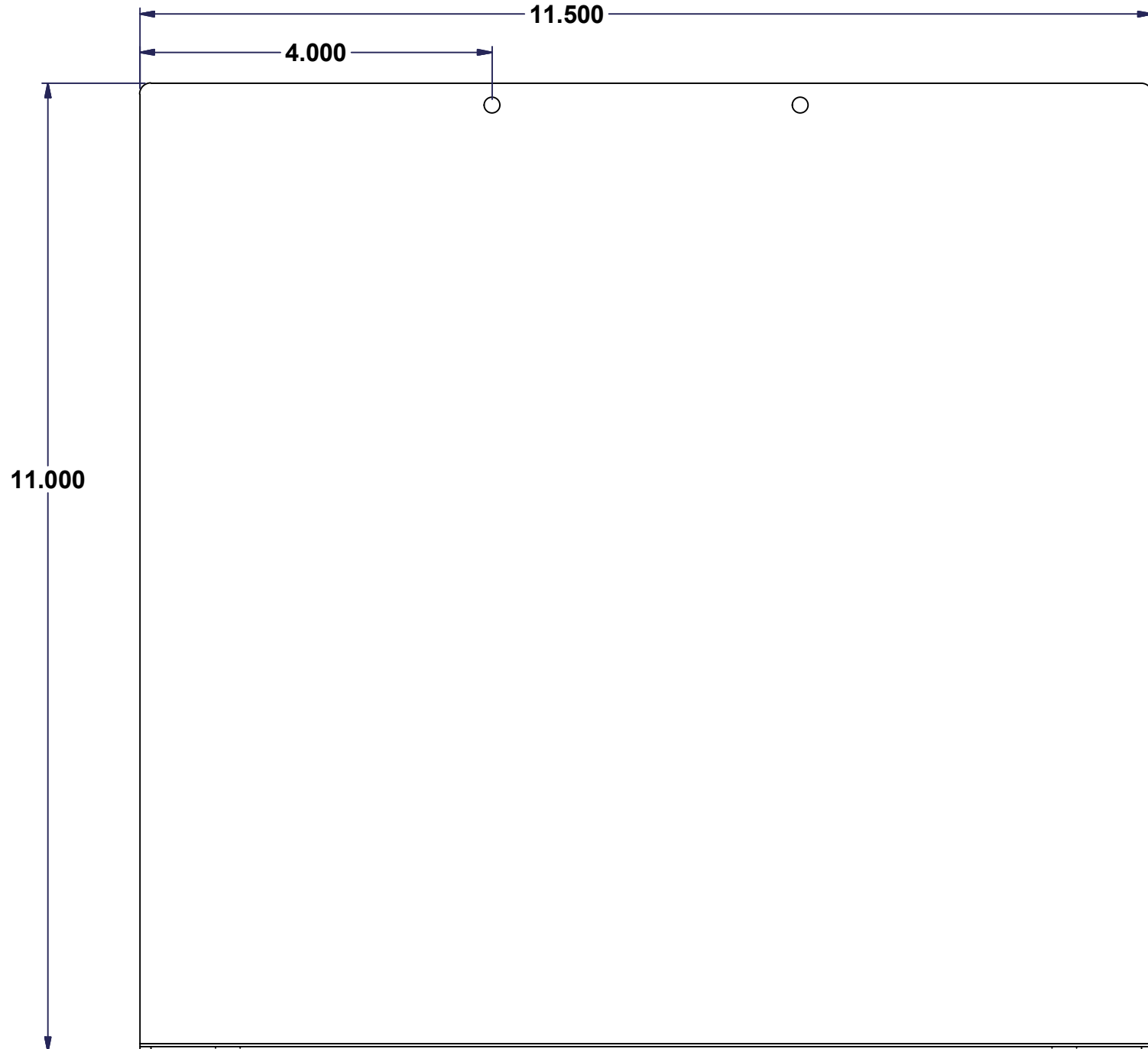
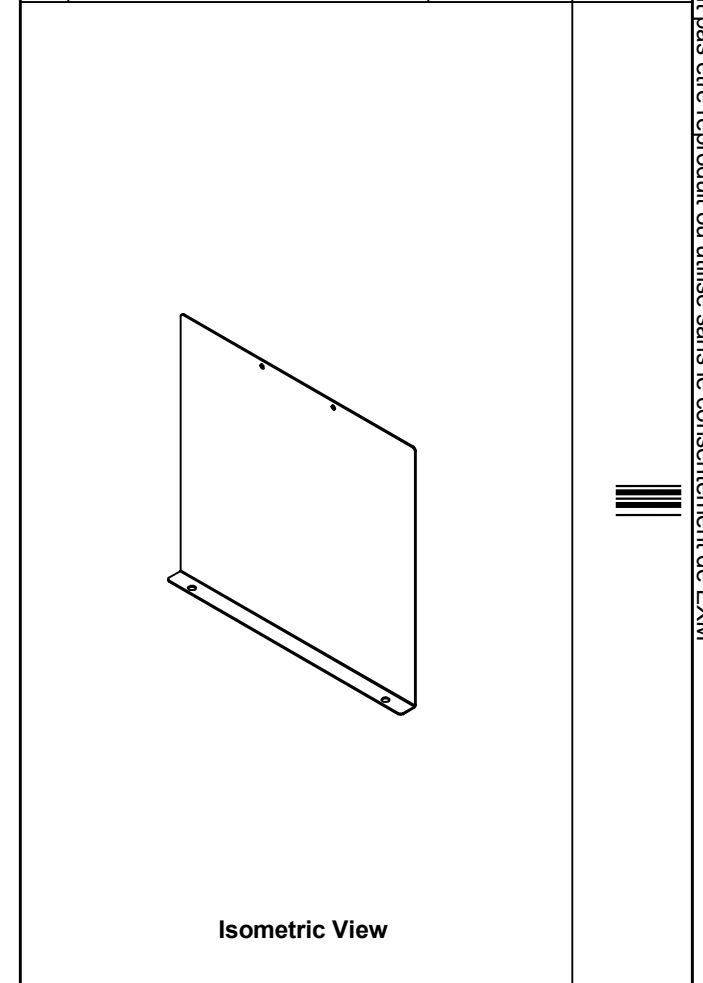

No.	Revisions	Date	By/Par

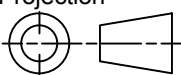

 Tél: (450) 979-4373 Fax: (450) 979-4626 www.exmweb.com	Flatness Aplatissement Max 3.0mm
	Projection 
Customer Client	Date
Drawn By / Dessiné Par: MichaelA	Date: 02-Feb-15
Material / Matière: 16 Ga H.R.P. & O. (1.4mm)	
Color / Couleur	Finish / Fini
Description: 1100 Barrier 12" High x 12" Long	
Detail Rev.	
Part Number / Numéro Pièce: 1100BA12012	Rev. 1

Ce dessin est confidentiel et ne doit pas être reproduit ou utilisé sans le consentement de EXM