

This drawing is confidential and must not be reproduced or used without the consent of EXM

Ce dessin est confidentiel et ne doit pas être reproduit ou utilisé sans le consentement de EXM

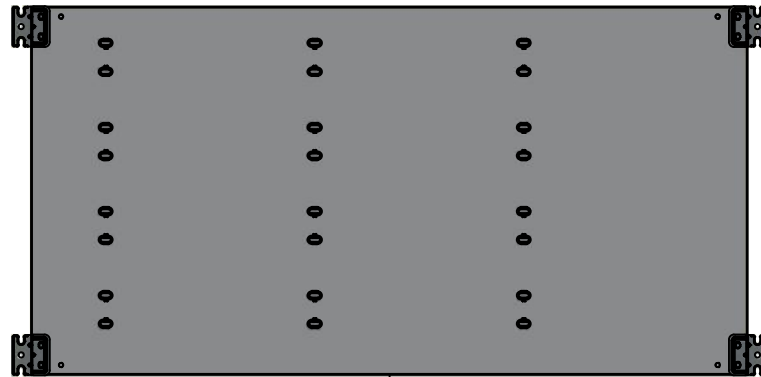

TOP



BACK

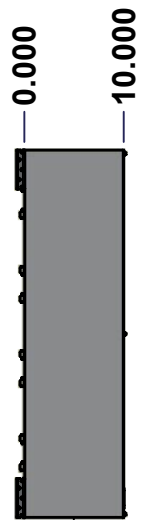

LEFT

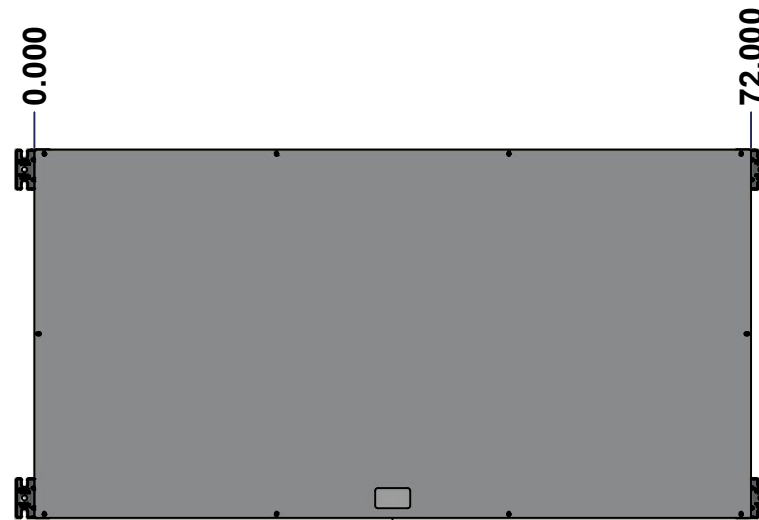

FRONT

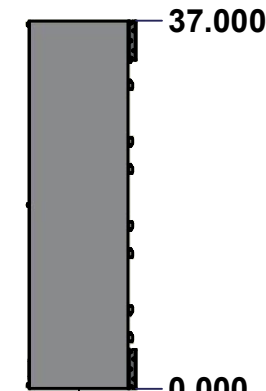

RIGHT



BOTTOM

No.	Revisions	Date	By/Par

**Isometric View**

Tél: (450) 979-4373 Fax: (450) 979-4626 <a href="http://www.exmweb.com">www.exmweb.com</a>		Flatness Aplatissement	
		Max 3.0mm	
Customer Client		Date	
Drawn By Dessiné Par BoxCad: BoxCad		Date 29-Jul-22	
Material Matière 14 Ga Cold Rolled A1008 CS Type B (1.7mm)			
Color Couleur Asa-61 Grey		Finish Fini Smooth	
Description 1100BT 2500A - 4Wires x 72" Assembly			Detail Rev.
Part Number Numéro Pièce <b>1100BT062504</b>		Rev. <b>0</b>	1 8

SEE BILL OF MATERIAL ON LAST PAGE

This drawing is confidential and must not be reproduced or used without the consent of Eurobox

**STANDARD FEATURES ARE NOT LISTED IN THIS HOLE TABLE**

Ce dessin est confidentiel et ne doit pas être reproduit ou utilisé sans le consentement de Eurobox

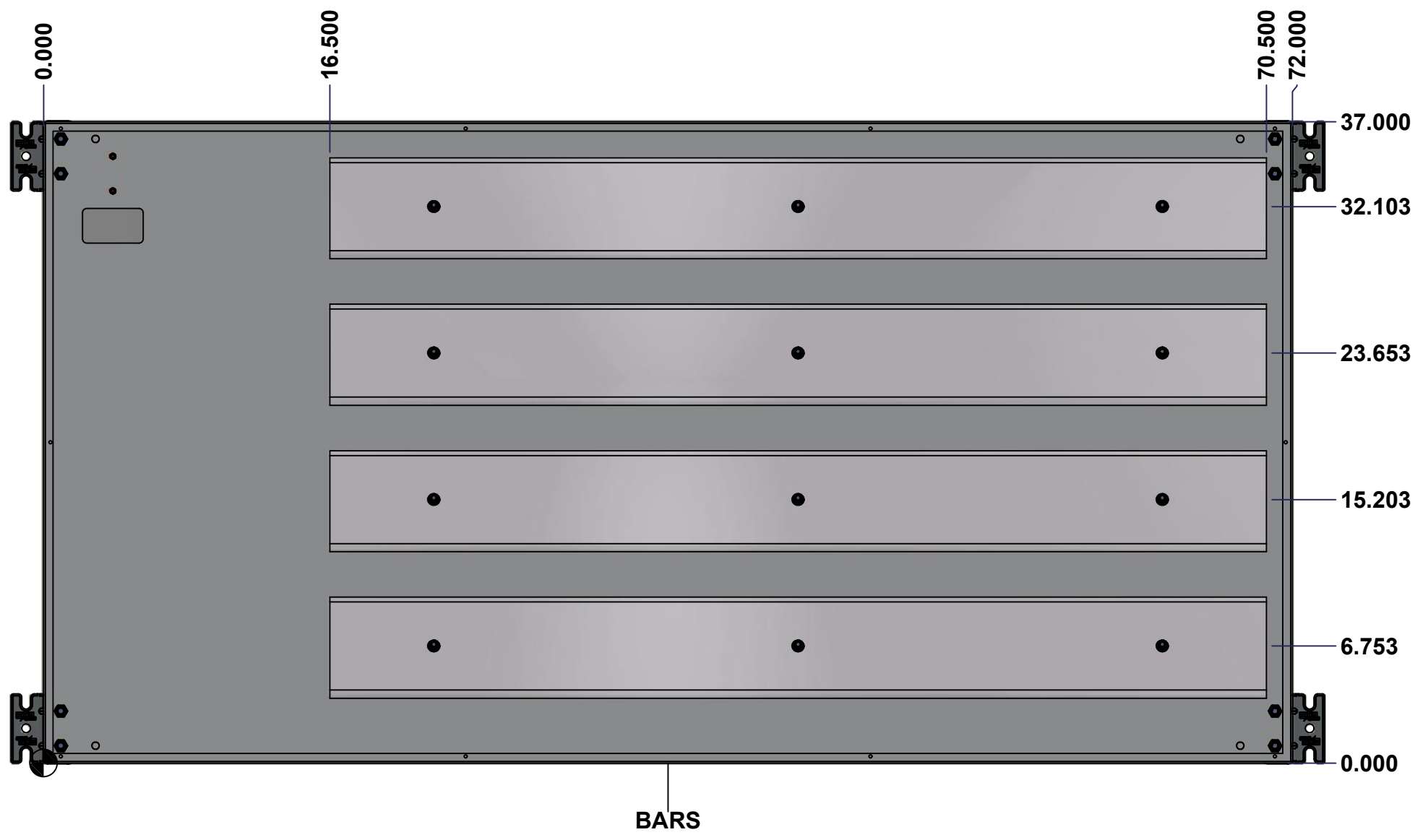

	Description 1100BT 2500A - 4Wires x 72" Assembly	Status (NULL)
	Part Number Numéro Pièce <b>1100BT062504</b>	Rev. 2 <b>0</b> / 8

This drawing is confidential and must not be reproduced or used without the consent of EXM

Ce dessin est confidentiel et ne doit pas être reproduit ou utilisé sans le consentement de EXM

NOTE	
ITEM	DESCRIPTION
1	NEMA 1 Enclosure
2	C/W Standard ground studs on box and cover
3	W/O Standard door stiffener
4	W/O Inner panel
5	W/O Inner panel mounting studs

No.	Revisions	Date	By/Par

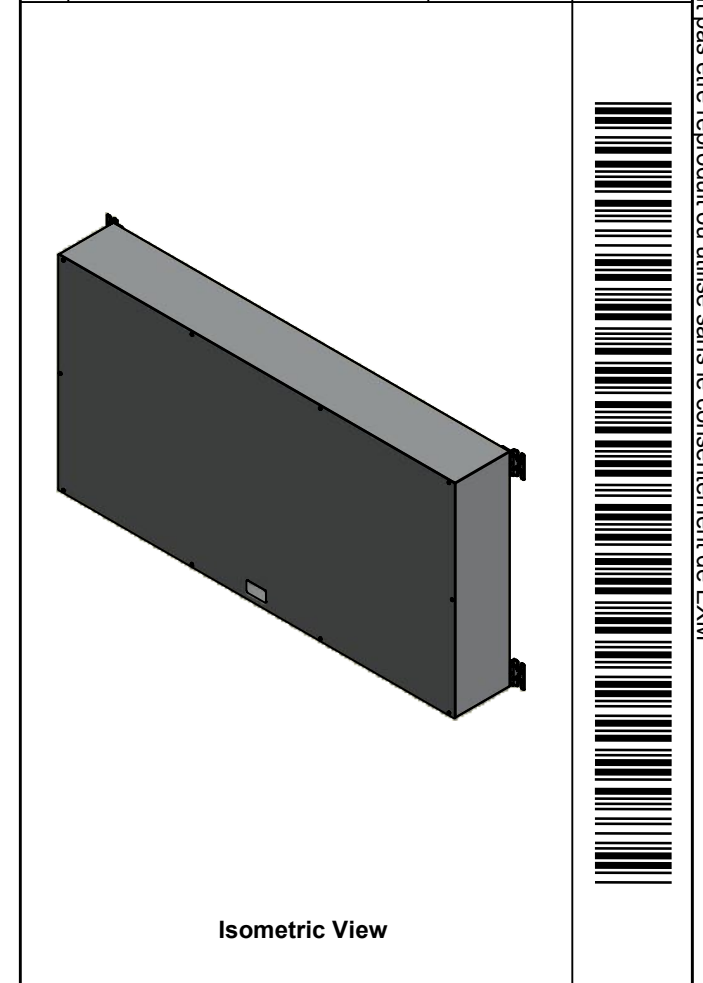

PACKING		
ITEM	QTY	DESCRIPTION
Cardboard sleeve	2	Top and Bottom
Cardboard strip	2	Between back of enclosure and inner panel
Plastic bag	1	To protect cover surface and inside gasket
Cardboard corner	4	To reinforced for the plastic strap tightening
Plastic strap - Black	2	To Squeeze 2 cardboard sleeve together
Packaging label	3	White label with PN
Plastic strap- Green	2	To secure the enclosure to the wood pallet
Wood Pallet	1	2" deeper and 3" larger than enclosure size

2	885 BTMF	0	885 BTMF Mounting Feet Kit
1	1100BT062504BAR3-P	0	Rounded Edge Aluminum Bar 3/4" x 6"
1	1100BT062504BAR2-P	0	Rounded Edge Aluminum Bar 3/4" x 6"
1	1100BT062504BAR1-P	0	Rounded Edge Aluminum Bar 3/4" x 6"
1	1100BT062504BAR4-P	0	Rounded Edge Aluminum Bar 3/4" x 6"
12	STK-Q-07310	2	Flange Lock Nut M8
12	STK-A-67400	0	Buss Bar Insulator Kit
10	STK-Q-05020	5	M5 x 8mm Thread Rolling Screw
1	1100BT062504C	0	1100BT 37" x 72" Cover
1	1100BT062504B	0	1100BT 37" x 72" x 10" Body
Qty	Part Number	Rev	Description
Parts List			

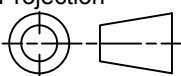
 Tél: (450) 979-4373 Fax: (450) 979-4626 <a href="http://www.exmweb.com">www.exmweb.com</a>	Flatness Aplatissement Max 3.0mm
	Projection 
Customer Client	Date
Drawn By Dessiné Par BoxCad: BoxCad	Date 29-Jul-22
Material Matière 14 Ga Cold Rolled A1008 CS Type B (1.7mm)	
Color Couleur Asa-61 Grey	Finish Fini Smooth
Description 1100BT 2500A - 4Wires x 72" Assembly	Detail Rev.
Part Number Numéro Pièce <b>1100BT062504</b>	Rev. <b>0</b>
	3 8

This drawing is confidential and must not be reproduced or used without the consent of EXM

Ce dessin est confidentiel et ne doit pas être reproduit ou utilisé sans le consentement de EXM



TOP

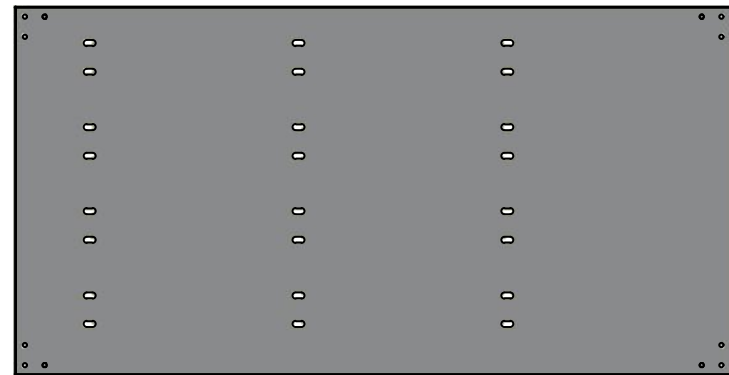

BACK



LEFT

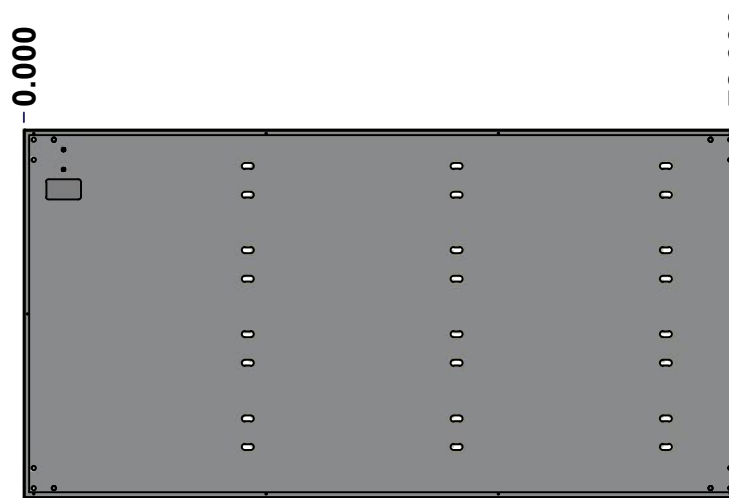

FRONT

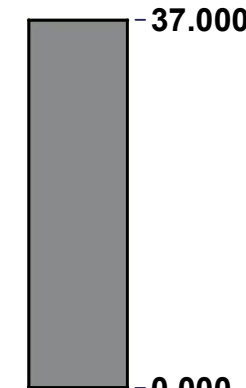

RIGHT



BOTTOM

No.	Revisions	Date	By/Par

**Isometric View**

Tél: (450) 979-4373 Fax: (450) 979-4626 <a href="http://www.exmweb.com">www.exmweb.com</a>		Flatness Aplatissement	
		Max 3.0mm	
Customer Client		Date	
Drawn By Dessiné Par BoxCad: BoxCad		Date 29-Jul-22	
Material Matière 14 Ga Cold Rolled A1008 CS Type B (1.7mm)			
Color Couleur Asa-61 Grey		Finish Fini Smooth	
Description 1100BT 37" x 72" x 10" Body			Detail Rev.
Part Number Numéro Pièce <b>1100BT062504B</b>		Rev. <b>0</b>	4 8

**SEE BILL OF MATERIAL ON LAST PAGE**

This drawing is confidential and must not be reproduced or used without the consent of Eurobox

Ce dessin est confidentiel et ne doit pas être reproduit ou utilisé sans le consentement de Eurobox

STANDARD FEATURES ARE NOT LISTED IN THIS HOLE TABLE			
HOLE TABLE - BACK VIEW (CUSTOM FEATURE ONLY)			
CUT-OUT	XDIM	YDIM	DESCRIPTION
1	68.000	35.000	GND STUD M8 x 35mm (Inside)
2	68.000	33.000	GND STUD M8 x 35mm (Inside)

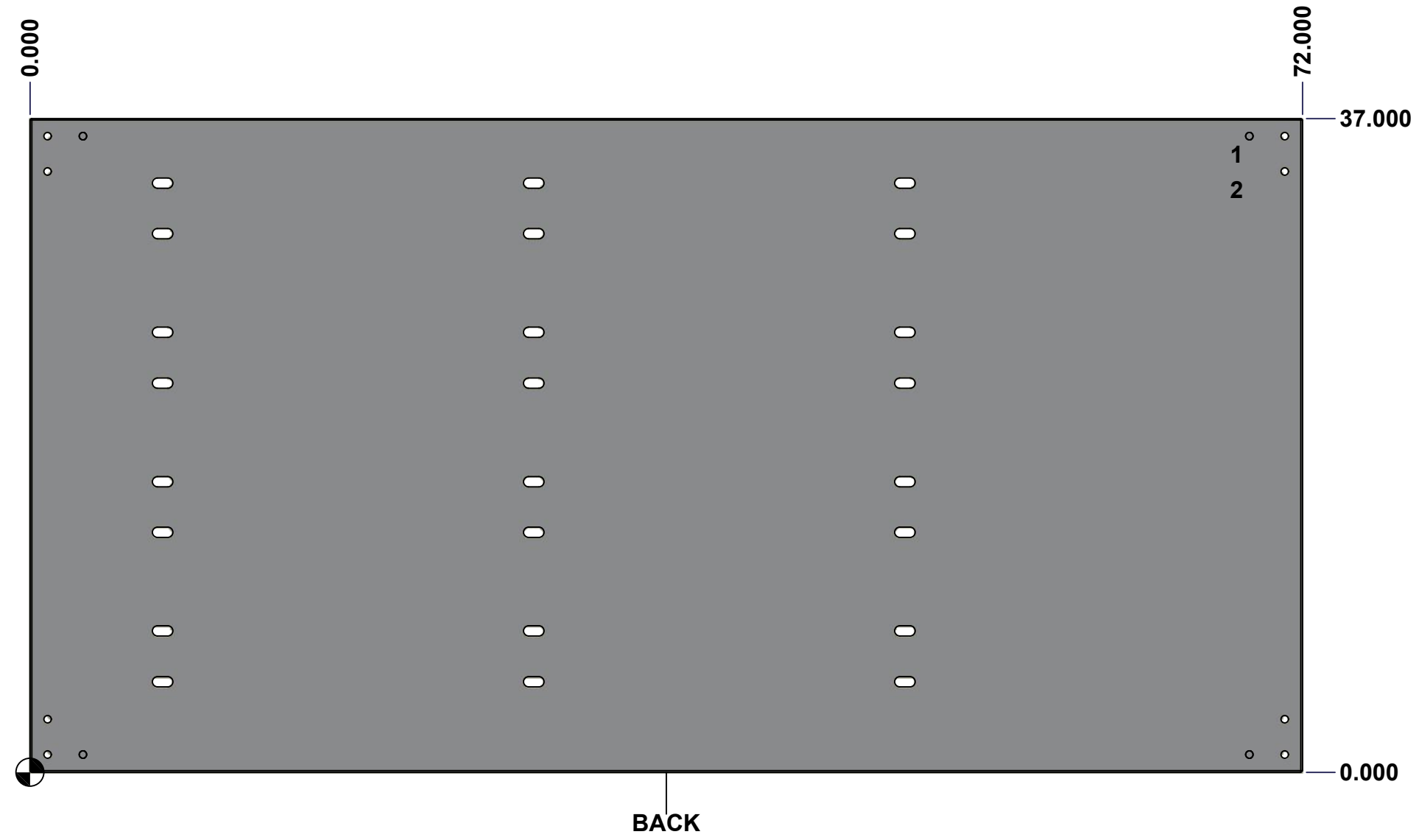



	Description	Status	
	1100BT 37" x 72" x 10" Body	(NULL)	
	Part Number Numéro Pièce	Rev.	
	<b>1100BT062504B</b>	<b>0</b>	5 8

This drawing is confidential and must not be reproduced or used without the consent of EXM

Ce dessin est confidentiel et ne doit pas être reproduit ou utilisé sans le consentement de EXM

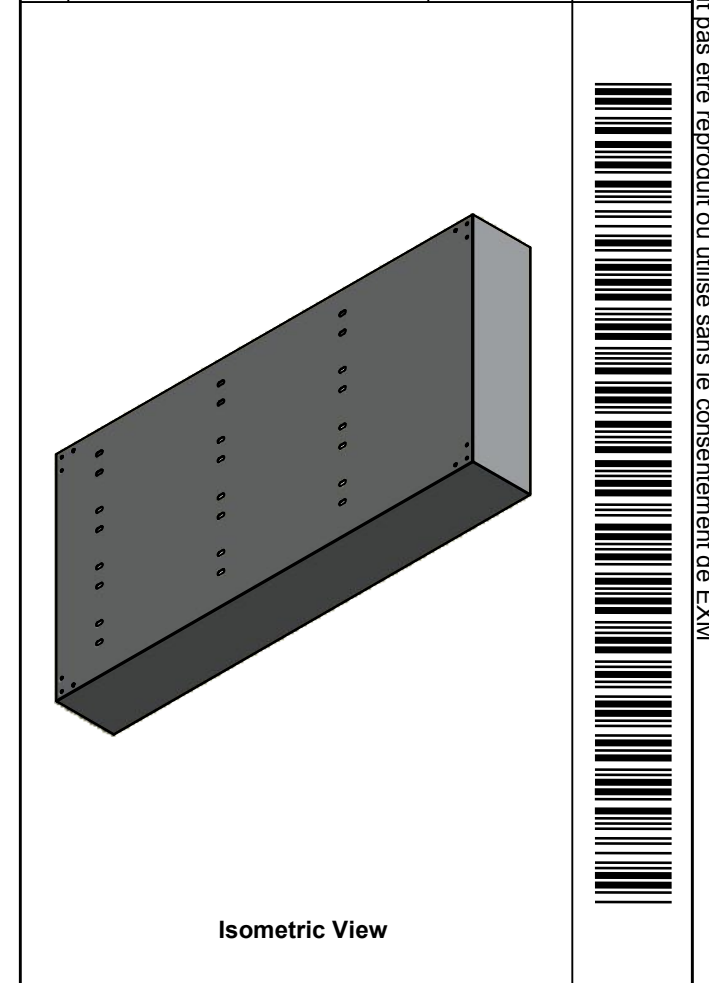
No.	Revisions	Date	By/Par



 Tél: (450) 979-4373 Fax: (450) 979-4626 <a href="http://www.exmweb.com">www.exmweb.com</a>		Flatness Aplatissement Max 3.0mm
Customer Client		Date
Drawn By / Dessiné Par: BoxCad: BoxCad		Date: 29-Jul-22
Material / Matière: 14 Ga Cold Rolled A1008 CS Type B (1.7mm)		
Color / Couleur: Asa-61 Grey	Finish / Fini: Smooth	
Description: 1100BT 37" x 72" x 10" Body		Detail Rev.
Part Number / Numéro Pièce: <b>1100BT062504B</b>		Rev. 0 / 6 / 8

Qty	Part Number	Rev	Description
1	STK-P-02400S	0	Powder Paint (Asa-61 Grey / Smooth)
1	STK-S-00100	0	3.5" x 2" Silver Milar Flexcon Sticker
2	STK-Q-16005	1	Stud M8 x 35 (No Paint Cap Required)
1	1100BT062504B-P	0	1100BT 37" x 72" x 10" Body Part
Parts List			

This drawing is confidential and must not be reproduced or used without the consent of EXM

Ce dessin est confidentiel et ne doit pas être reproduit ou utilisé sans le consentement de EXM

TOP



BACK

LEFT

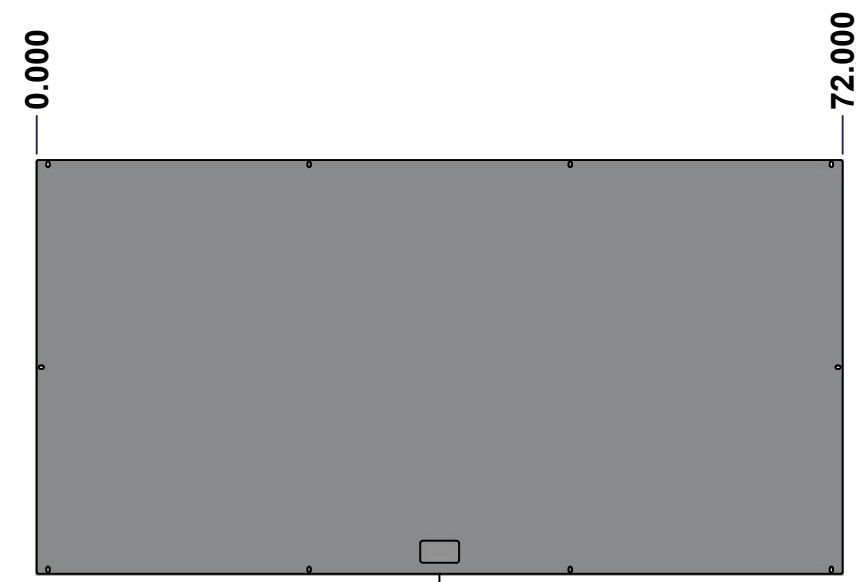



FRONT

RIGHT

BOTTOM

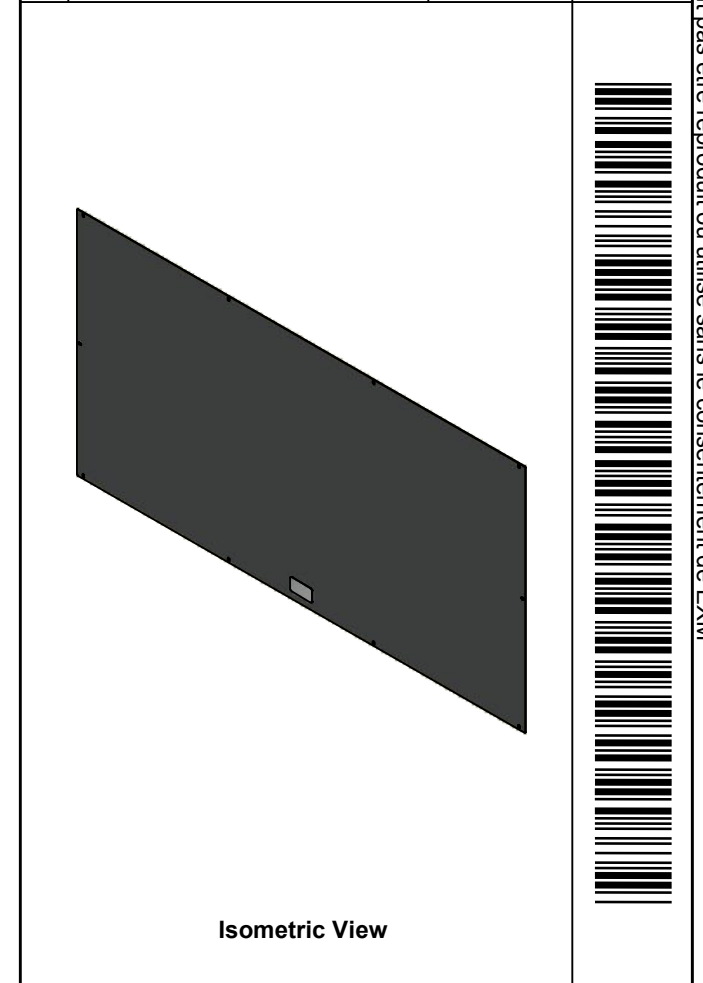
No.	Revisions	Date	By/Par

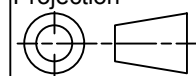

 Tél: (450) 979-4373 Fax: (450) 979-4626 <a href="http://www.exmweb.com">www.exmweb.com</a>		Flatness Aplatissement Max 3.0mm Projection 
Customer Client	Date	
Drawn By Dessiné Par	BoxCad: BoxCad	Date 29-Jul-22
Material Matière	14 Ga Cold Rolled A1008 CS Type B (1.7mm)	
Color Couleur	Asa-61 Grey	Finish Fini Smooth
Description	Detail Rev.	
1100BT 37" x 72" Cover		
Part Number Numéro Pièce	Rev.	7
<b>1100BT062504C</b>	<b>0</b>	8

SEE BILL OF MATERIAL ON LAST PAGE

This drawing is confidential and must not be reproduced or used without the consent of EXM

Ce dessin est confidentiel et ne doit pas être reproduit ou utilisé sans le consentement de EXM

No.	Revisions	Date	By/Par

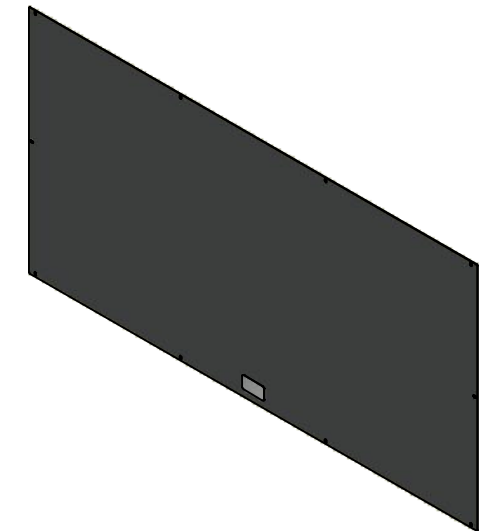

Isometric View

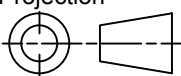

 Tél: (450) 979-4373 Fax: (450) 979-4626 <a href="http://www.exmweb.com">www.exmweb.com</a>		Flatness Aplatissement Max 3.0mm
Customer Client		Projection 
Drawn By / Dessiné Par: BoxCad: BoxCad		Date: 29-Jul-22
Material / Matière: 14 Ga Cold Rolled A1008 CS Type B (1.7mm)		
Color / Couleur: Asa-61 Grey	Finish / Fini: Smooth	
Description: 1100BT 37" x 72" Cover		Detail Rev.
Part Number / Numéro Pièce: <b>1100BT062504C</b>		Rev. 8 <b>0</b>

Qty	Part Name	Rev	Description
1	STK-P-02400S	0	Powder Paint (Asa-61 Grey / Smooth)
1	STK-S-00100	0	3.5" x 2" Silver Milar Flexcon Sticker
1	1100BT062504C-P	0	1100BT 37" x 72" Flat Cover Part
Parts List			