

This drawing is confidential and must not be reproduced or used without the consent of EXM

Ce dessin est confidentiel et ne doit pas être reproduit ou utilisé sans le consentement de EXM

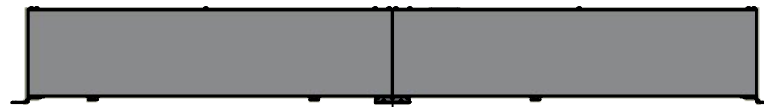

TOP

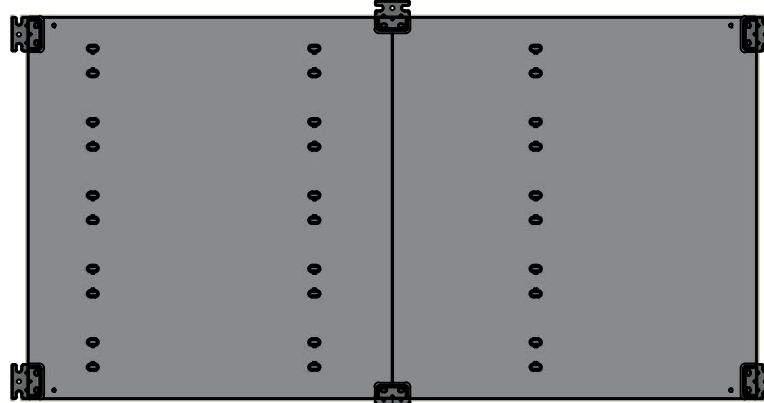

BACK

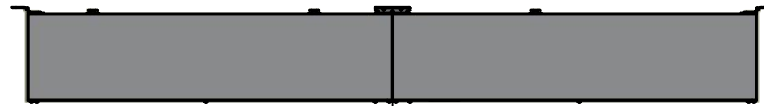

BOTTOM

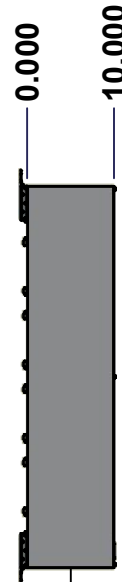

LEFT

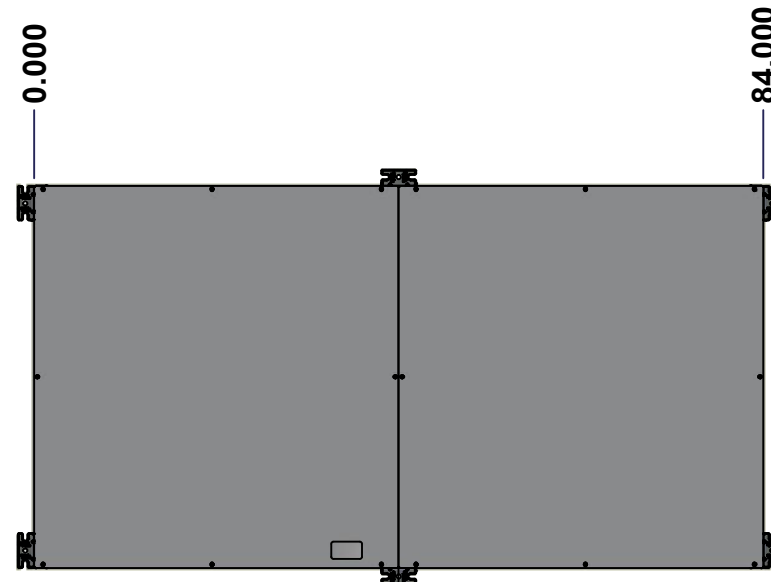

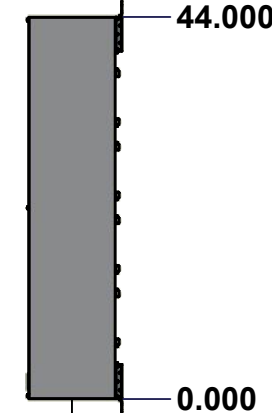

FRONT

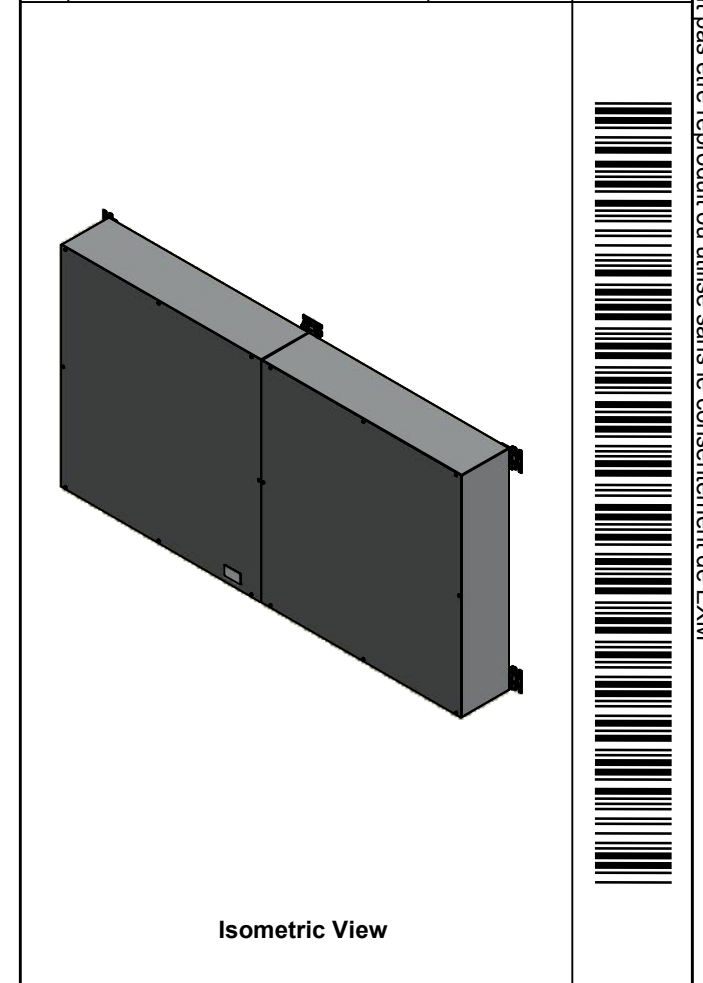

RIGHT

No.	Revisions	Date	By/Par

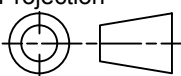

 Tél: (450) 979-4373 Fax: (450) 979-4626 <a href="http://www.exmweb.com">www.exmweb.com</a>		Flatness Aplatissement Max 3.0mm Projection 
Customer Client	Date	
Drawn By Dessiné Par	BoxCad: BoxCad	Date 29-Jul-22
Material Matière	14 Ga Cold Rolled A1008 CS Type B (1.7mm)	
Color Couleur	Asa-61 Grey	Finish Fini Smooth
Description 1100BT 2000A - 5Wires x 84" Assembly		Detail Rev.
Part Number Numéro Pièce	1100BT072005	Rev. 0

SEE BILL OF MATERIAL ON LAST PAGE

1  
8

This drawing is confidential and must not be reproduced or used without the consent of Eurobex

Ce dessin est confidentiel et ne doit pas être reproduit ou utilisé sans le consentement de Eurobex

**STANDARD FEATURES ARE NOT LISTED IN THIS HOLE TABLE**

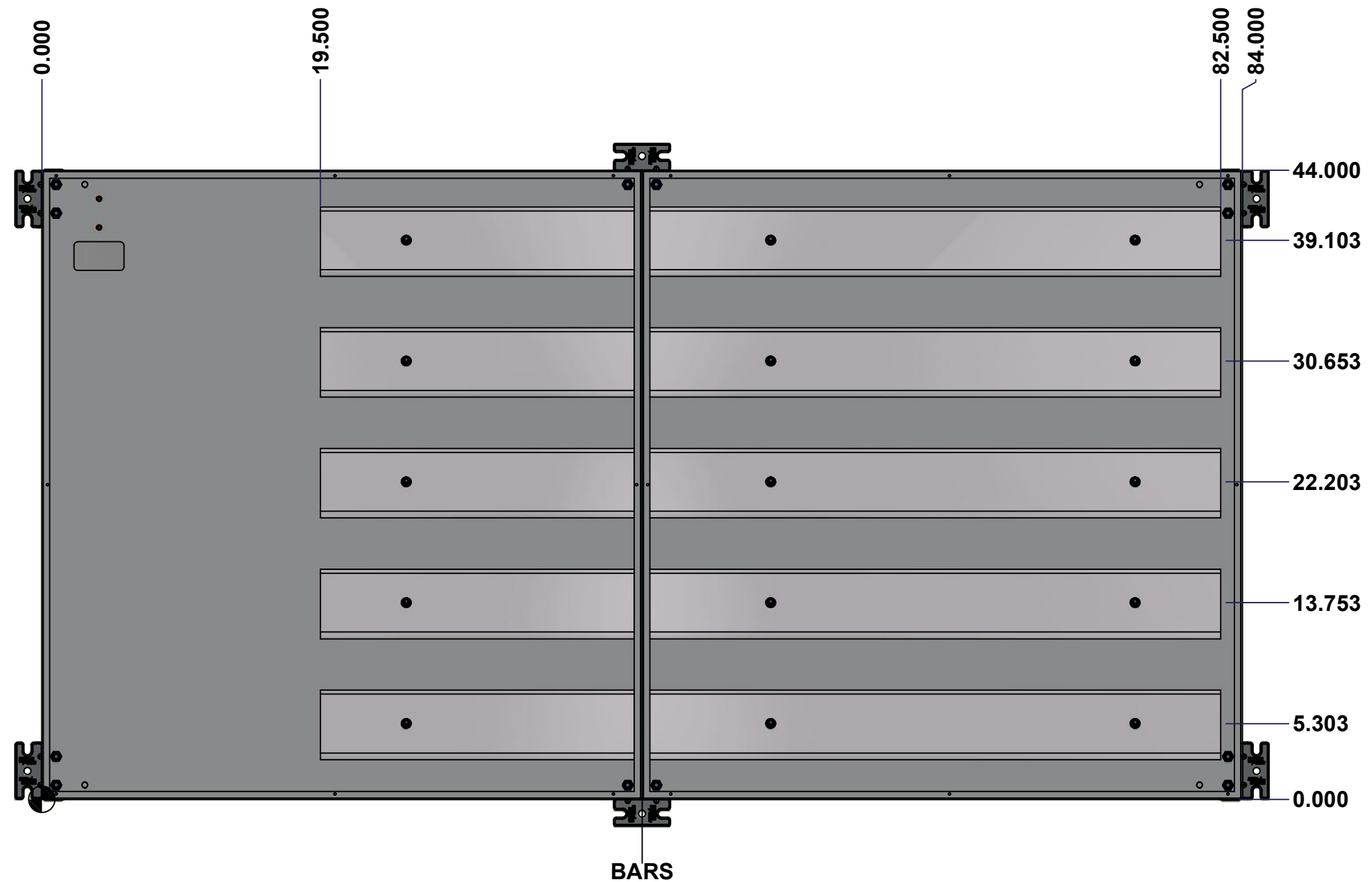

	Description	Status	
	1100BT 2000A - 5Wires x 84" Assembly	(NULL)	
	Part Number	Rev.	2
	Numéro Pièce	<b>0</b>	8
	<b>1100BT072005</b>		

This drawing is confidential and must not be reproduced or used without the consent of EXM

Ce dessin est confidentiel et ne doit pas être reproduit ou utilisé sans le consentement de EXM

NOTE	
ITEM	DESCRIPTION
1	NEMA 1 Enclosure
2	C/W Standard ground studs on box and cover
3	W/O Standard door stiffener
4	W/O Inner panel
5	W/O Inner panel mounting studs

No.	Revisions	Date	By/Par

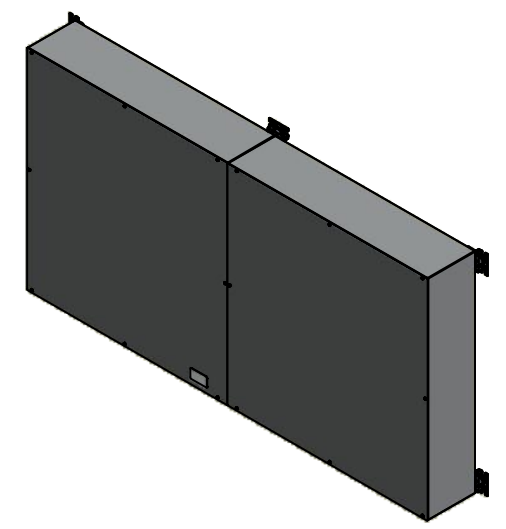

Isometric View

PACKING		
ITEM	QTY	DESCRIPTION
Cardboard sleeve	2	Top and Bottom
Cardboard strip	2	Between back of enclosure and inner panel
Plastic bag	1	To protect cover surface and inside gasket
Cardboard corner	4	To reinforced for the plastic strap tightening
Plastic strap - Black	2	To Squeeze 2 cardboard sleeve together
Packaging label	3	White label with PN
Plastic strap- Green	2	To secure the enclosure to the wood pallet
Wood Pallet	1	2" deeper and 3" larger than enclosure size

1	1100BT072005BAR5-P	0	Rounded Edge Aluminum Bar 3/4" x 5"
1	1100BT072005BAR4-P	0	Rounded Edge Aluminum Bar 3/4" x 5"
1	1100BT072005BAR3-P	0	Rounded Edge Aluminum Bar 3/4" x 5"
1	1100BT072005BAR2-P	0	Rounded Edge Aluminum Bar 3/4" x 5"
1	1100BT072005BAR1-P	0	Rounded Edge Aluminum Bar 3/4" x 5"
15	STK-Q-07310	2	Flange Lock Nut M8
15	STK-A-67400	0	Buss Bar Insulator Kit
10	STK-Q-03210	0	Thread Cutting Screw 1/4-20 x 5/16"
16	STK-Q-05020	5	M5 x 8mm Thread Rolling Screw
1	1100BT072005C	0	1100BT 44" x 84" Cover
1	1100BT072005B	0	1100BT 44" x 84" x 10" Body
3	885 BTMF	0	885 BTMF Mounting Feet Kit
Qty	Part Number	Rev	Description
Parts List			



Tél: (450) 979-4373  
Fax: (450) 979-4626  
[www.exmweb.com](http://www.exmweb.com)

Flatness  
Aplatissement  
Max 3.0mm

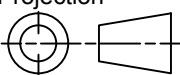
Projection  

Customer Client		Date
Drawn By Dessiné Par BoxCad: BoxCad		Date 29-Jul-22
Material Matière 14 Ga Cold Rolled A1008 CS Type B (1.7mm)		
Color Couleur Asa-61 Grey	Finish Fini Smooth	
Description 1100BT 2000A - 5Wires x 84" Assembly		Detail Rev.
Part Number Numéro Pièce <b>1100BT072005</b>		Rev. <b>0</b>

This drawing is confidential and must not be reproduced or used without the consent of EXM

Ce dessin est confidentiel et ne doit pas être reproduit ou utilisé sans le consentement de EXM



TOP

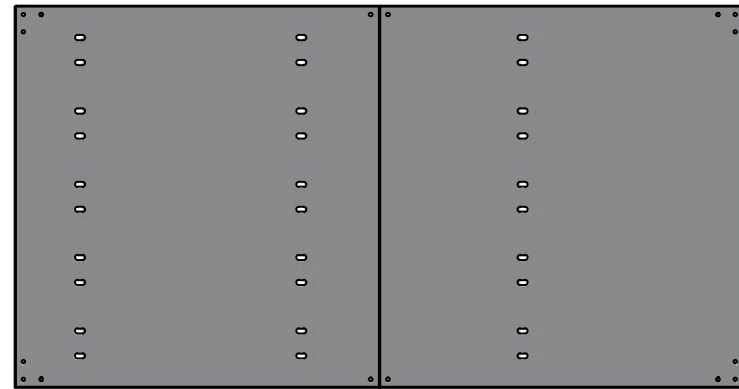

BACK



BOTTOM

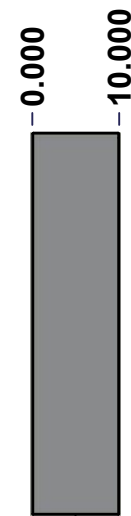

LEFT



FRONT

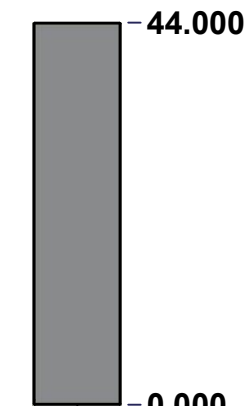

RIGHT

No.	Revisions	Date	By/Par

**Isometric View**

Tél: (450) 979-4373 Fax: (450) 979-4626 <a href="http://www.exmweb.com">www.exmweb.com</a>		Flatness Aplatissement	
		Max 3.0mm	
Customer Client		Date	
Drawn By Dessiné Par BoxCad: BoxCad		Date 29-Jul-22	
Material Matière 14 Ga Cold Rolled A1008 CS Type B (1.7mm)			
Color Couleur Asa-61 Grey		Finish Fini Smooth	
Description 1100BT 44" x 84" x 10" Body			Detail Rev.
Part Number Numéro Pièce <b>1100BT072005B</b>		Rev. <b>0</b>	4 8

SEE BILL OF MATERIAL ON LAST PAGE

This drawing is confidential and must not be reproduced or used without the consent of Eurobox

Ce dessin est confidentiel et ne doit pas être reproduit ou utilisé sans le consentement de Eurobox

<b>STANDARD FEATURES ARE NOT LISTED IN THIS HOLE TABLE</b>			
<b>HOLE TABLE - BACK VIEW (CUSTOM FEATURE ONLY)</b>			
CUT-OUT	XDIM	YDIM	DESCRIPTION
1	80.000	42.000	GND STUD M8 x 35mm (Inside)
2	80.000	40.000	GND STUD M8 x 35mm (Inside)

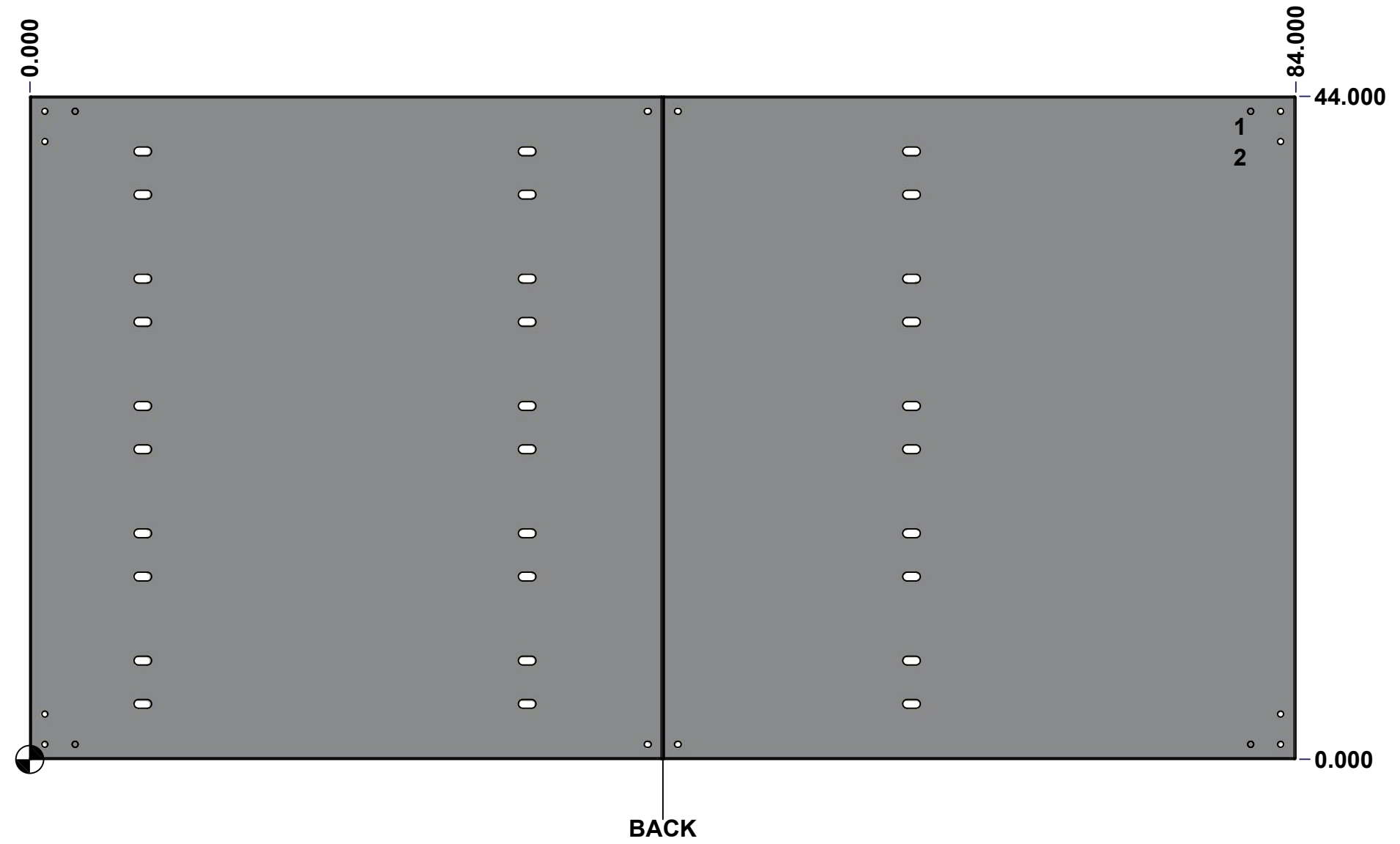



	Description	Status	
	1100BT 44" x 84" x 10" Body	(NULL)	
	Part Number Numéro Pièce	Rev.	5
	<b>1100BT072005B</b>	<b>0</b>	8

This drawing is confidential and must not be reproduced or used without the consent of EXM

Ce dessin est confidentiel et ne doit pas être reproduit ou utilisé sans le consentement de EXM

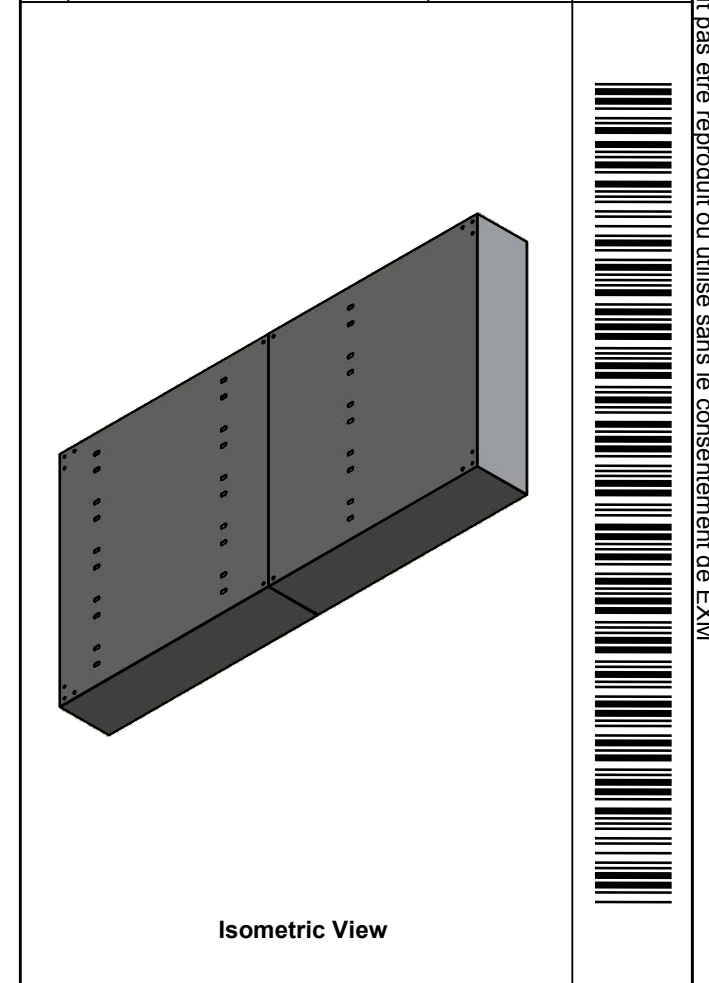
No.	Revisions	Date	By/Par

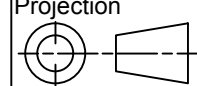

 Tél: (450) 979-4373 Fax: (450) 979-4626 <a href="http://www.exmweb.com">www.exmweb.com</a>		Flatness Aplatissement Max 3.0mm Projection 
Customer Client	Date	
Drawn By Dessiné Par	BoxCad: BoxCad	Date 29-Jul-22
Material Matière	14 Ga Cold Rolled A1008 CS Type B (1.7mm)	
Color Couleur	Asa-61 Grey	Finish Fini Smooth
Description		Detail Rev.
1100BT 44" x 84" x 10" Body		
Part Number Numéro Pièce	Rev.	6
<b>1100BT072005B</b>	<b>0</b>	8

Qty	Part Number	Rev	Description
1	STK-P-02400S	0	Powder Paint (Asa-61 Grey / Smooth)
1	1100BT072005B-P	0	1100BT 44" x 84" x 10" Body Part
1	STK-S-00100	0	3.5" x 2" Silver Milar Flexcon Sticker
2	STK-Q-16005	1	Stud M8 x 35 (No Paint Cap Required)
1	1100BT072005E-P	0	1100BT 44" x 84" x 10" Body Part
Parts List			

This drawing is confidential and must not be reproduced or used without the consent of EXM

Ce dessin est confidentiel et ne doit pas être reproduit ou utilisé sans le consentement de EXM

TOP

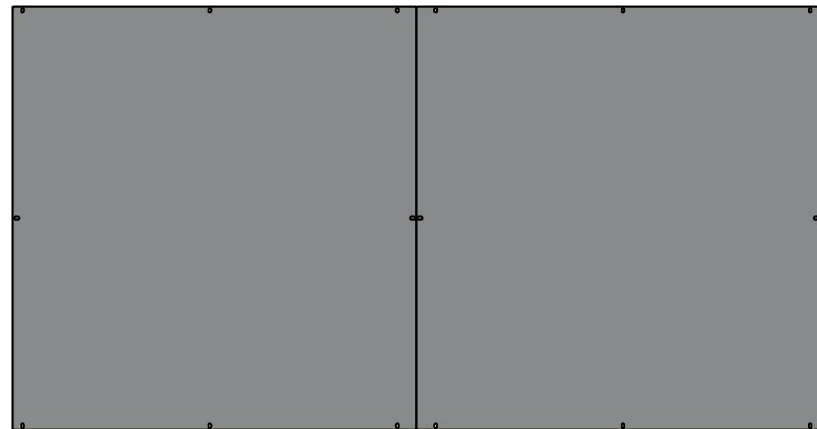

BACK

LEFT

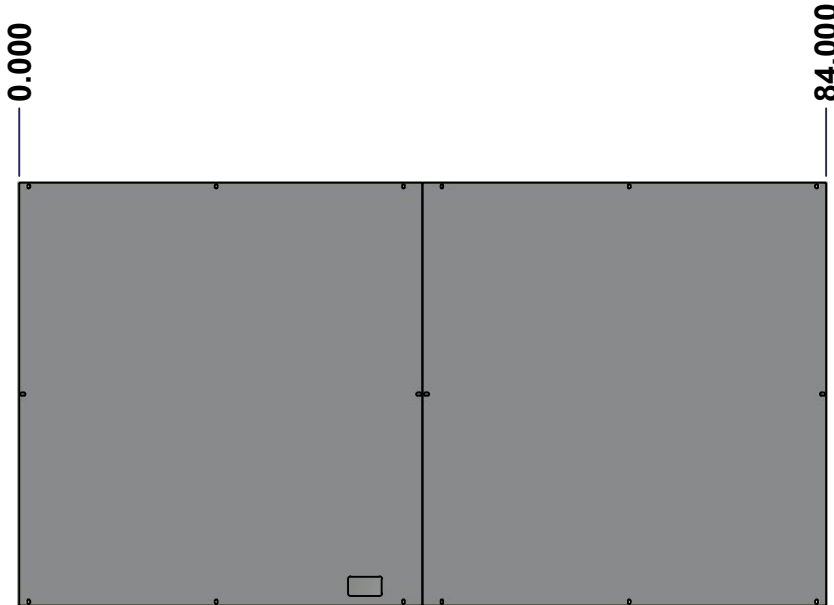

FRONT



RIGHT

BOTTOM

No.	Revisions	Date	By/Par

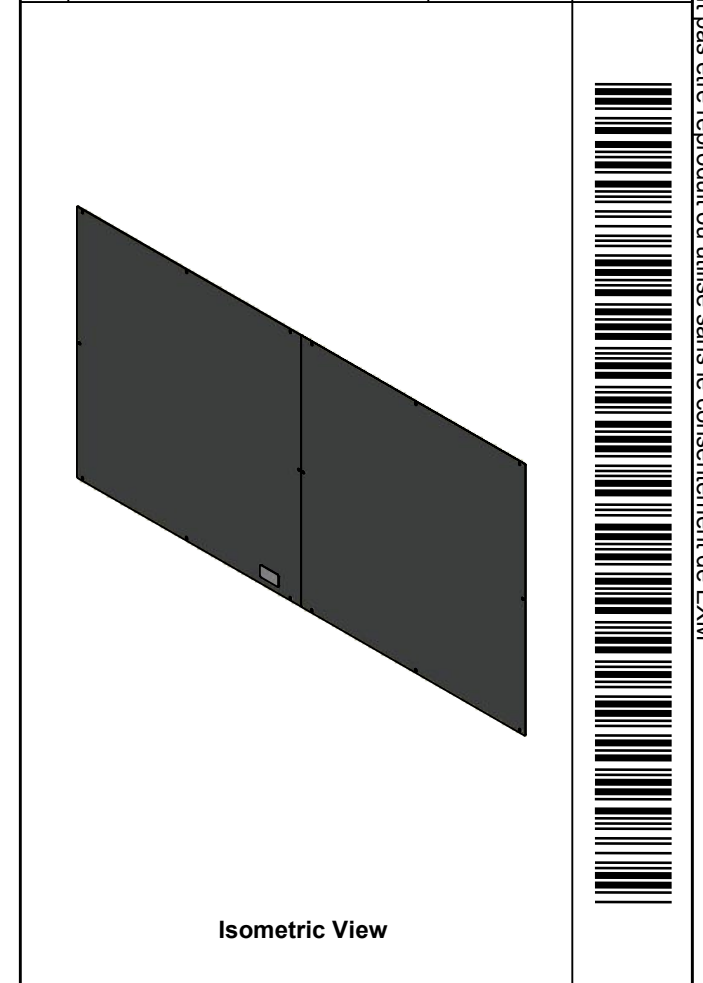

Isometric View

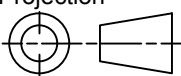
 Tél: (450) 979-4373 Fax: (450) 979-4626 <a href="http://www.exmweb.com">www.exmweb.com</a>		Flatness Aplatissement Max 3.0mm Projection 
Customer Client	Date	
Drawn By Dessiné Par	BoxCad: BoxCad	Date 29-Jul-22
Material Matière	14 Ga Cold Rolled A1008 CS Type B (1.7mm)	
Color Couleur	Asa-61 Grey	Finish Fini Smooth
Description	Detail Rev.	
1100BT 44" x 84" Cover		
Part Number Numéro Pièce	Rev.	7
<b>1100BT072005C</b>	<b>0</b>	8

SEE BILL OF MATERIAL ON LAST PAGE

This drawing is confidential and must not be reproduced or used without the consent of EXM

Ce dessin est confidentiel et ne doit pas être reproduit ou utilisé sans le consentement de EXM

No.	Revisions	Date	By/Par

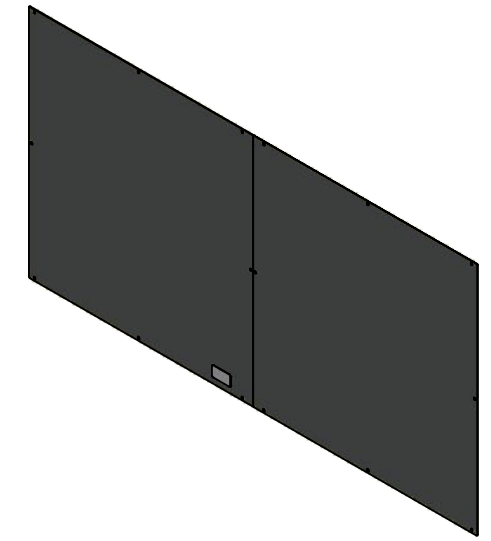

Isometric View

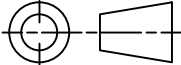
 Tél: (450) 979-4373 Fax: (450) 979-4626 <a href="http://www.exmweb.com">www.exmweb.com</a>		Flatness Aplatissement Max 3.0mm Projection 
Customer Client	Date	
Drawn By Dessiné Par	BoxCad: BoxCad	Date 29-Jul-22
Material Matière	14 Ga Cold Rolled A1008 CS Type B (1.7mm)	
Color Couleur	Asa-61 Grey	Finish Fini Smooth
Description		Detail Rev.
1100BT 44" x 84" Cover		
Part Number Numéro Pièce	Rev.	8
<b>1100BT072005C</b>	<b>0</b>	<b>8</b>

Qty	Part Name	Rev	Description
1	STK-P-02400S	0	Powder Paint (Asa-61 Grey / Smooth)
1	1100BT072005F-P	0	1100BT 44" x 84" Flanged Cover Part
1	1100BT072005C-P	0	1100BT 44" x 84" Flat Cover Part
1	STK-S-00100	0	3.5" x 2" Silver Milar Flexcon Sticker
Parts List			