

This drawing is confidential and must not be reproduced or used without the consent of EXM

Ce dessin est confidentiel et ne doit pas être reproduit ou utilisé sans le consentement de EXM

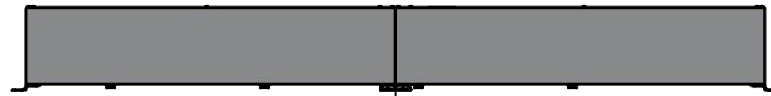

TOP

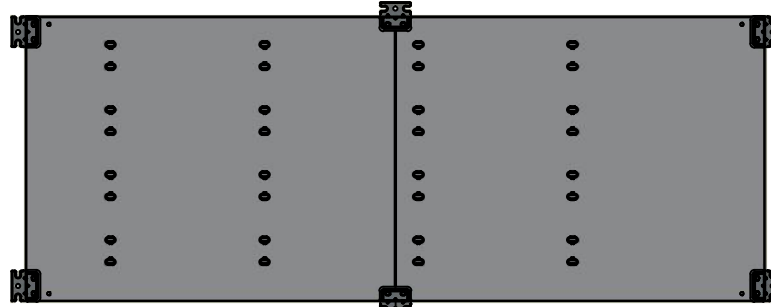

BACK

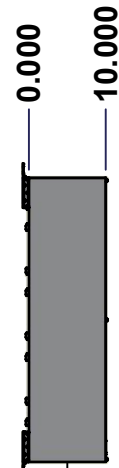

LEFT

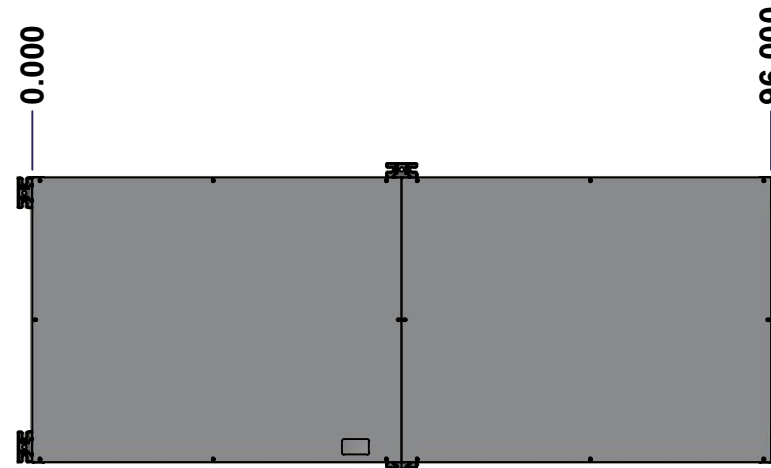

FRONT

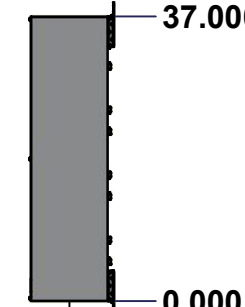

RIGHT

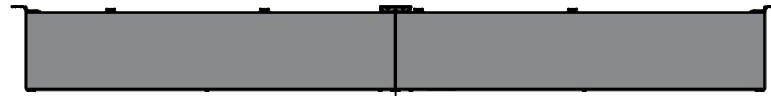

BOTTOM

| No. | Revisions | Date | By/Par |
|-----|-----------|------|--------|
| | | | |
| | | | |
| | | | |
| | | | |

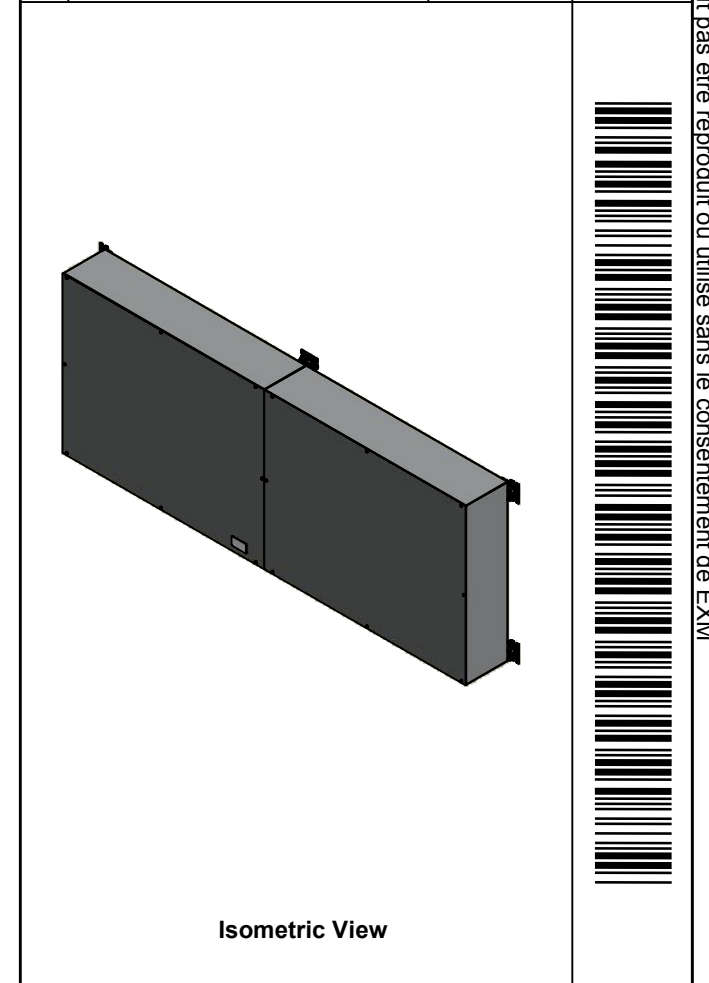

Isometric View

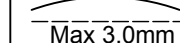
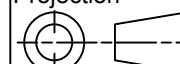
| | | |
|----------------------------------------------------------------------------------------------------------------------------------------------------------------------------------------|-------------------------------------------|-------------------------------------------------------------------------------------------------------------------------------------------------------------------------------------------------------------------------------------|
|  Tél: (450) 979-4373 Fax: (450) 979-4626 www.exmweb.com | | Flatness Aplatissement  Max 3.0mm Projection  |
| Customer Client | Date | |
| Drawn By Dessiné Par | BoxCad: BoxCad | Date 29-Jul-22 |
| Material Matière | 14 Ga Cold Rolled A1008 CS Type B (1.7mm) | |
| Color Couleur | Asa-61 Grey | Finish Fini Smooth |
| Description | Detail Rev. | |
| 1100BT 2000A - 4Wires x 96" Assembly | | |
| Part Number Numéro Pièce | Rev. 0 | 1/8 |
| 1100BT082004 | | |

SEE BILL OF MATERIAL ON LAST PAGE

This drawing is confidential and must not be reproduced or used without the consent of Eurobox

STANDARD FEATURES ARE NOT LISTED IN THIS HOLE TABLE

Ce dessin est confidentiel et ne doit pas être reproduit ou utilisé sans le consentement de Eurobox

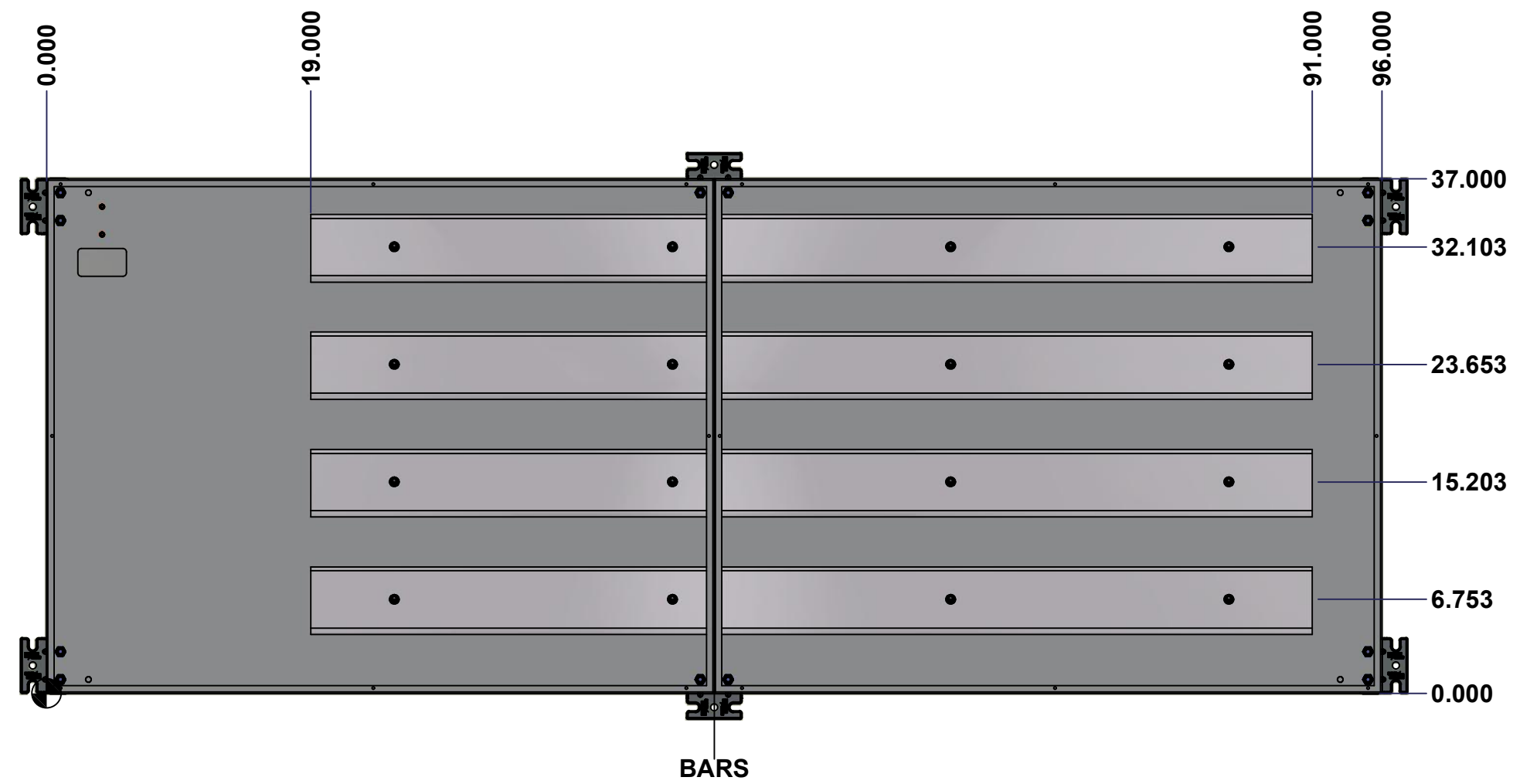

| | | | |
|--|--------------------------------------|----------|--------|
| | Description | Status | |
| | 1100BT 2000A - 4Wires x 96" Assembly | (NULL) | |
| | Part Number Numéro Pièce | Rev. | |
| | 1100BT082004 | 0 | 2 8 |

This drawing is confidential and must not be reproduced or used without the consent of EXM

Ce dessin est confidentiel et ne doit pas être reproduit ou utilisé sans le consentement de EXM

| NOTE | |
|------|--------------------------------------------|
| ITEM | DESCRIPTION |
| 1 | NEMA 1 Enclosure |
| 2 | C/W Standard ground studs on box and cover |
| 3 | W/O Standard door stiffener |
| 4 | W/O Inner panel |
| 5 | W/O Inner panel mounting studs |

| No. | Revisions | Date | By/Par |
|-----|-----------|------|--------|
| | | | |
| | | | |
| | | | |
| | | | |
| | | | |

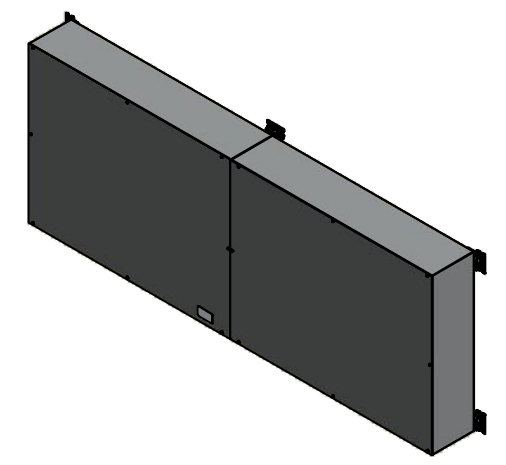

Isometric View

| PACKING | | |
|-----------------------|-----|------------------------------------------------|
| ITEM | QTY | DESCRIPTION |
| Cardboard sleeve | 2 | Top and Bottom |
| Cardboard strip | 2 | Between back of enclosure and inner panel |
| Plastic bag | 1 | To protect cover surface and inside gasket |
| Cardboard corner | 4 | To reinforced for the plastic strap tightening |
| Plastic strap - Black | 2 | To Squeeze 2 cardboard sleeve together |
| Packaging label | 3 | White label with PN |
| Plastic strap- Green | 2 | To secure the enclosure to the wood pallet |
| Wood Pallet | 1 | 2" deeper and 3" larger than enclosure size |

| | | | |
|------------|--------------------|-----|-------------------------------------|
| 1 | 1100BT082004BAR4-P | 0 | Rounded Edge Aluminum Bar 3/4" x 5" |
| 1 | 1100BT082004BAR3-P | 0 | Rounded Edge Aluminum Bar 3/4" x 5" |
| 1 | 1100BT082004BAR2-P | 0 | Rounded Edge Aluminum Bar 3/4" x 5" |
| 1 | 1100BT082004BAR1-P | 0 | Rounded Edge Aluminum Bar 3/4" x 5" |
| 16 | STK-Q-07310 | 2 | Flange Lock Nut M8 |
| 16 | STK-A-67400 | 0 | Buss Bar Insulator Kit |
| 10 | STK-Q-03210 | 0 | Thread Cutting Screw 1/4-20 x 5/16" |
| 16 | STK-Q-05020 | 5 | M5 x 8mm Thread Rolling Screw |
| 1 | 1100BT082004C | 0 | 1100BT 37" x 96" Cover |
| 1 | 1100BT082004B | 0 | 1100BT 37" x 96" x 10" Body |
| 3 | 885 BTMF | 0 | 885 BTMF Mounting Feet Kit |
| Qty | Part Number | Rev | Description |
| Parts List | | | |

| | | |
|--|-------------------------------------------------------------------------------------------------------------------------------------|----------------------------------------------------------------------------------------------------------------------------------------------------|
| | Tél: (450) 979-4373 Fax: (450) 979-4626 www.exmweb.com | Flatness Aplatissement Max 3.0mm Projection |
| | Customer Client Drawn By Dessiné Par Material Matière Color Couleur Description Part Number Numéro Pièce | Date Date BoxCad: BoxCad 14 Ga Cold Rolled A1008 CS Type B (1.7mm) Asa-61 Grey 1100BT 2000A - 4Wires x 96" Assembly 1100BT082004 |

This drawing is confidential and must not be reproduced or used without the consent of EXM

Ce dessin est confidentiel et ne doit pas être reproduit ou utilisé sans le consentement de EXM



TOP

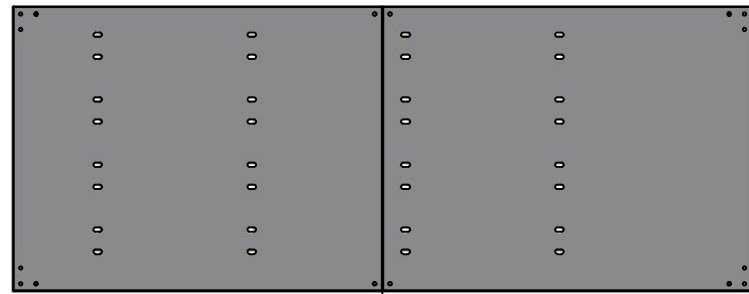

BACK

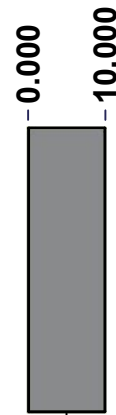

LEFT

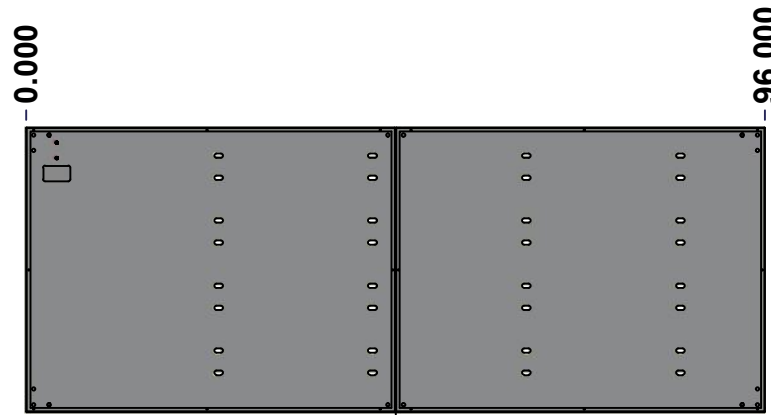

FRONT

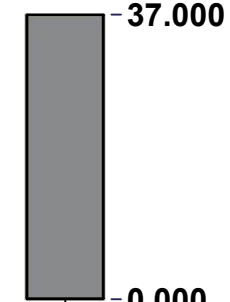

RIGHT



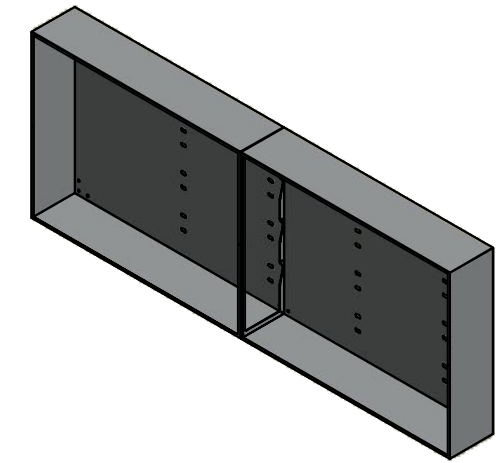

BOTTOM

| No. | Revisions | Date | By/Par |
|-----|-----------|------|--------|
| | | | |
| | | | |
| | | | |
| | | | |



Isometric View

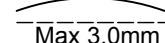

| | | |
|----------------------------------------------------------------------------------------------------------------------------------------------------------------------------------------|-------------------------------------------|----------------------------------------------------------------------------------------------------------------------------------------------------------------------------------------------------------------------------------------|
|  Tél: (450) 979-4373 Fax: (450) 979-4626 www.exmweb.com | | Flatness Aplatissement  Max 3.0mm Projection  |
| Customer Client | Date | |
| Drawn By Dessiné Par | BoxCad: BoxCad | Date 29-Jul-22 |
| Material Matière | 14 Ga Cold Rolled A1008 CS Type B (1.7mm) | |
| Color Couleur | Asa-61 Grey | Finish Fini Smooth |
| Description 1100BT 37" x 96" x 10" Body | | Detail Rev. |
| Part Number Numéro Pièce | 1100BT082004B | Rev. 4 0 |

SEE BILL OF MATERIAL ON LAST PAGE

This drawing is confidential and must not be reproduced or used without the consent of Eurobox

Ce dessin est confidentiel et ne doit pas être reproduit ou utilisé sans le consentement de Eurobox

| STANDARD FEATURES ARE NOT LISTED IN THIS HOLE TABLE | | | |
|------------------------------------------------------------|--------|--------|-----------------------------|
| HOLE TABLE - BACK VIEW (CUSTOM FEATURE ONLY) | | | |
| CUT-OUT | XDIM | YDIM | DESCRIPTION |
| 1 | 92.000 | 35.000 | GND STUD M8 x 35mm (Inside) |
| 2 | 92.000 | 33.000 | GND STUD M8 x 35mm (Inside) |

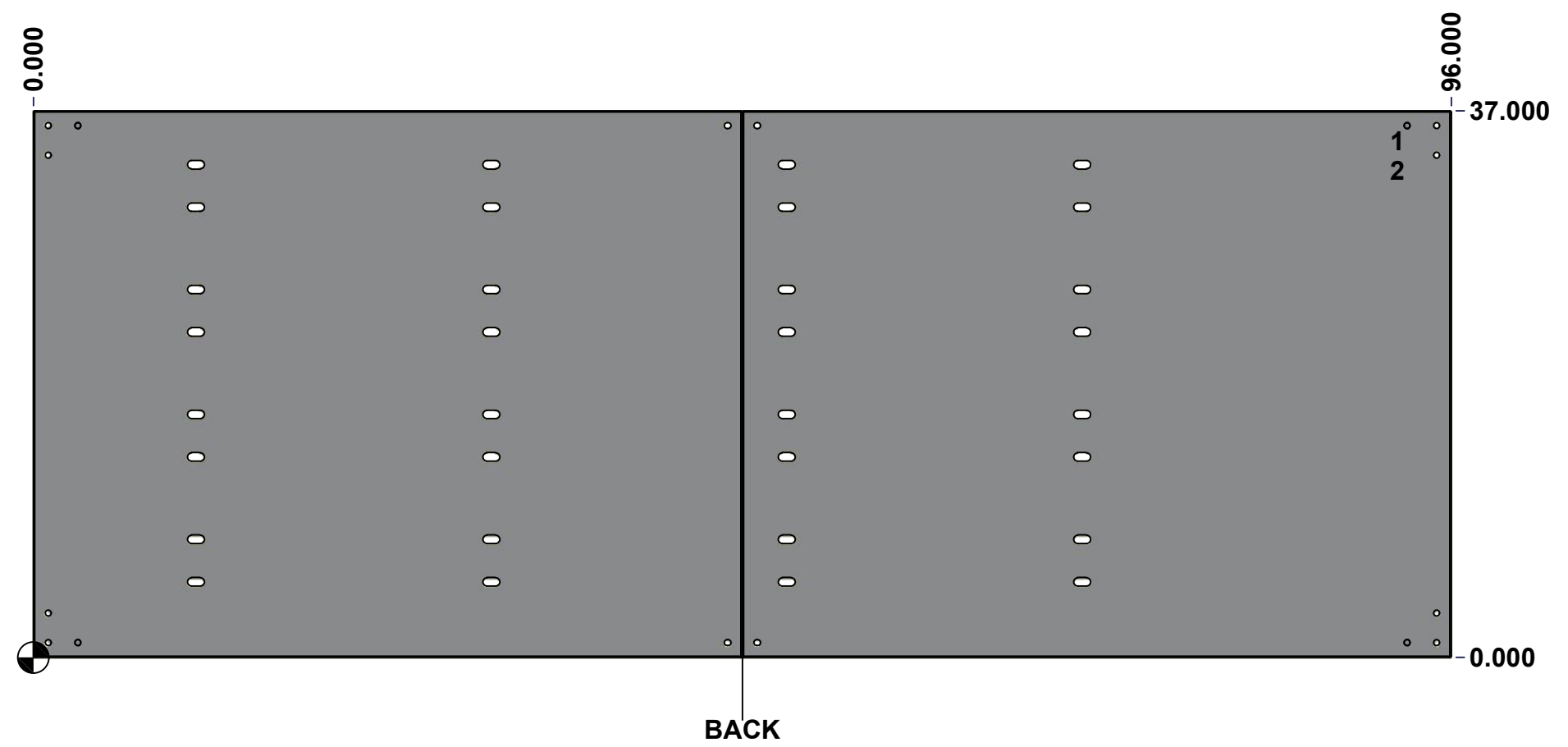

| | | | |
|--|-----------------------------|----------|--------|
| | Description | Status | |
| | 1100BT 37" x 96" x 10" Body | (NULL) | |
| | Part Number Numéro Pièce | Rev. | |
| | 1100BT082004B | 0 | 5 8 |

This drawing is confidential and must not be reproduced or used without the consent of EXM

Ce dessin est confidentiel et ne doit pas être reproduit ou utilisé sans le consentement de EXM

| No. | Revisions | Date | By/Par |
|-----|-----------|------|--------|
| | | | |
| | | | |
| | | | |
| | | | |
| | | | |

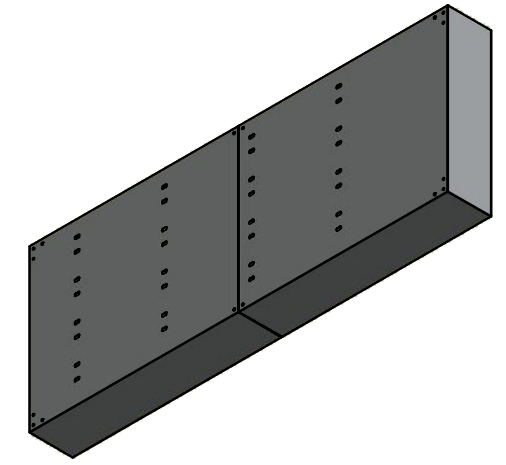

Isometric View



 Tél: (450) 979-4373
 Fax: (450) 979-4626
www.exmweb.com

Flatness / Aplatissement: Max 3.0mm
 Projection: 

| | |
|---------------------------------------------------------------|-----------------|
| Customer Client | Date |
| Drawn By / Dessiné Par: BoxCad: BoxCad | Date: 29-Jul-22 |
| Material / Matière: 14 Ga Cold Rolled A1008 CS Type B (1.7mm) | |

| | |
|------------------------------|-----------------------|
| Color / Couleur: Asa-61 Grey | Finish / Fini: Smooth |
|------------------------------|-----------------------|

| | |
|------------------------------------------|-------------|
| Description: 1100BT 37" x 96" x 10" Body | Detail Rev. |
|------------------------------------------|-------------|

| | | |
|--------------------------------------------------|--------|-------|
| Part Number / Numéro Pièce: 1100BT082004B | Rev. 0 | 6 / 8 |
|--------------------------------------------------|--------|-------|

| Qty | Part Number | Rev | Description |
|------------|-----------------|-----|----------------------------------------|
| 1 | STK-P-02400S | 0 | Powder Paint (Asa-61 Grey / Smooth) |
| 1 | 1100BT082004B-P | 0 | 1100BT 37" x 96" x 10" Body Part |
| 1 | STK-S-00100 | 0 | 3.5" x 2" Silver Milar Flexcon Sticker |
| 2 | STK-Q-16005 | 1 | Stud M8 x 35 (No Paint Cap Required) |
| 1 | 1100BT082004E-P | 0 | 1100BT 37" x 96" x 10" Body Part |
| Parts List | | | |

This drawing is confidential and must not be reproduced or used without the consent of EXM

Ce dessin est confidentiel et ne doit pas être reproduit ou utilisé sans le consentement de EXM

TOP

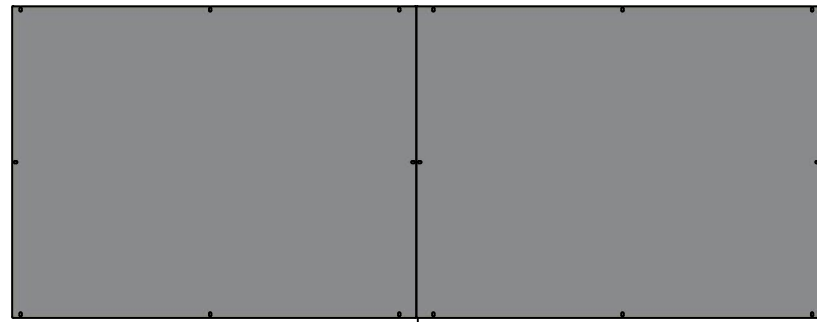

BACK

LEFT

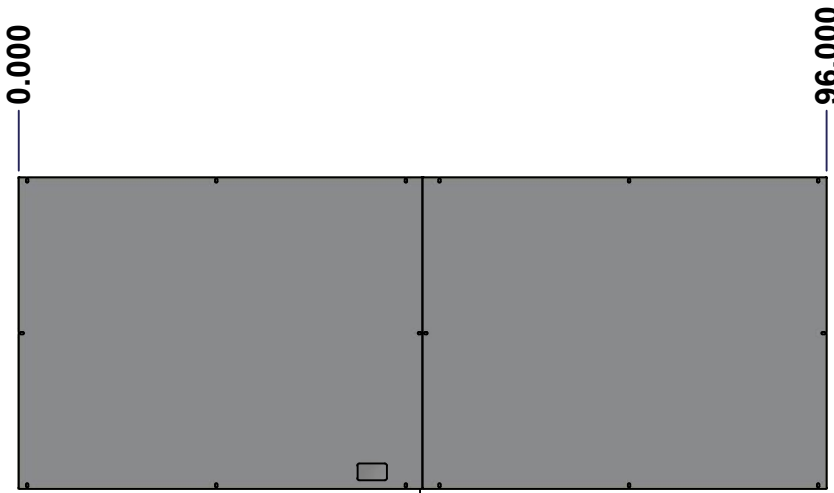

FRONT

RIGHT

BOTTOM

| No. | Revisions | Date | By/Par |
|-----|-----------|------|--------|
| | | | |
| | | | |
| | | | |
| | | | |
| | | | |

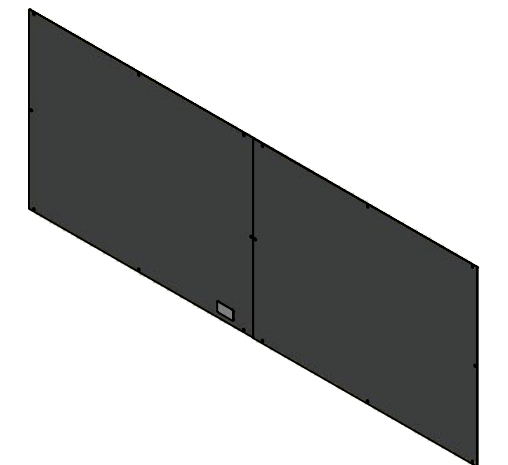

Isometric View



Tél: (450) 979-4373
 Fax: (450) 979-4626
www.exmweb.com

Flatness
Aplatissement
Max 3.0mm
Projection

| | |
|---------------------------------------------------------------|-----------------------|
| Customer Client | Date |
| Drawn By Dessiné Par BoxCad: BoxCad | Date 29-Jul-22 |
| Material Matière 14 Ga Cold Rolled A1008 CS Type B (1.7mm) | |
| Color Couleur Asa-61 Grey | Finish Fini Smooth |
| Description 1100BT 37" x 96" Cover | Detail Rev. |
| Part Number Numéro Pièce 1100BT082004C | Rev. 0 |

SEE BILL OF MATERIAL ON LAST PAGE

7
8

This drawing is confidential and must not be reproduced or used without the consent of EXM

Ce dessin est confidentiel et ne doit pas être reproduit ou utilisé sans le consentement de EXM

| No. | Revisions | Date | By/Par |
|-----|-----------|------|--------|
| | | | |
| | | | |
| | | | |
| | | | |
| | | | |

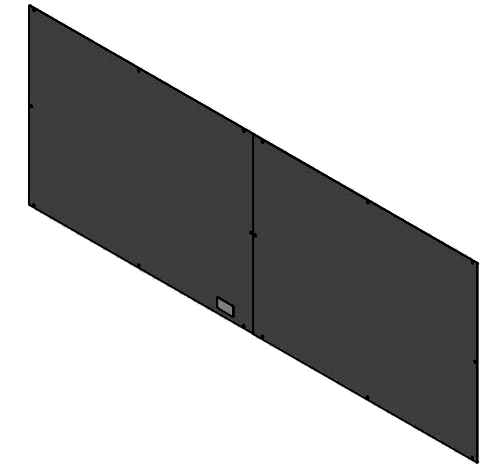

Isometric View



Tél: (450) 979-4373
 Fax: (450) 979-4626
www.exmweb.com

Flatness
Aplatissement

Max 3.0mm

Projection

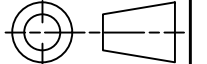

| | |
|---------------------------------------------------------------|-----------------------|
| Customer Client | Date |
| Drawn By / Dessiné Par: BoxCad: BoxCad | Date: 29-Jul-22 |
| Material / Matière: 14 Ga Cold Rolled A1008 CS Type B (1.7mm) | |
| Color / Couleur: Asa-61 Grey | Finish / Fini: Smooth |

| Qty | Part Name | Rev | Description |
|------------|-----------------|-----|----------------------------------------|
| 1 | STK-P-02400S | 0 | Powder Paint (Asa-61 Grey / Smooth) |
| 1 | 1100BT082004F-P | 0 | 1100BT 37" x 96" Flanged Cover Part |
| 1 | 1100BT082004C-P | 0 | 1100BT 37" x 96" Flat Cover Part |
| 1 | STK-S-00100 | 0 | 3.5" x 2" Silver Milar Flexcon Sticker |
| Parts List | | | |

| | |
|--------------------------------------------------|-------------|
| Description: 1100BT 37" x 96" Cover | Detail Rev. |
| Part Number / Numéro Pièce: 1100BT082004C | Rev. 0 / 8 |