

This drawing is confidential and must not be reproduced or used without the consent of EXM

Ce dessin est confidentiel et ne doit pas être reproduit ou utilisé sans le consentement de EXM

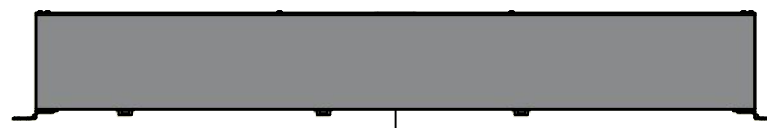

TOP

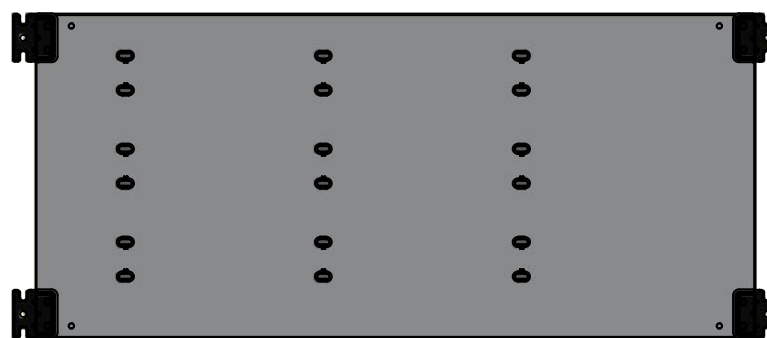

BACK



BOTTOM

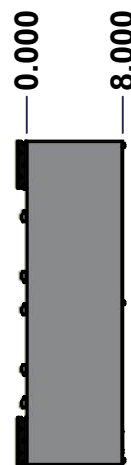

LEFT

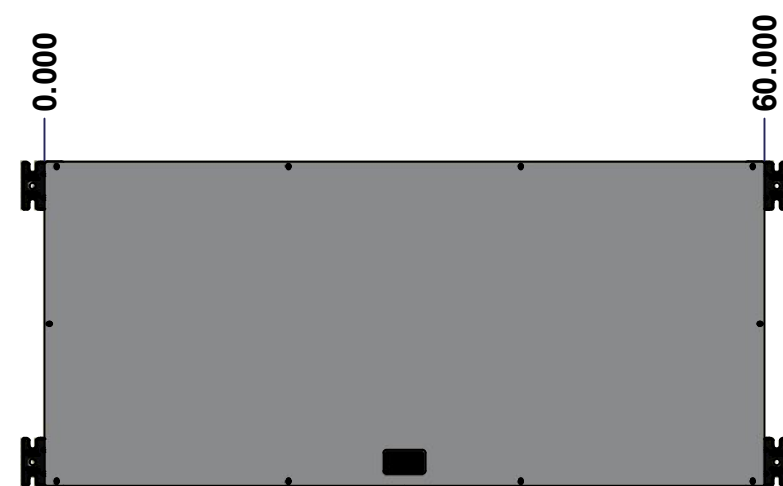

FRONT

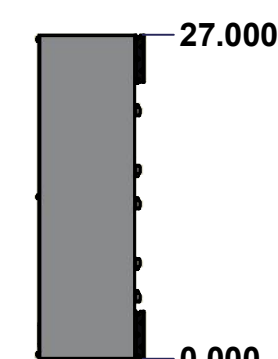

RIGHT

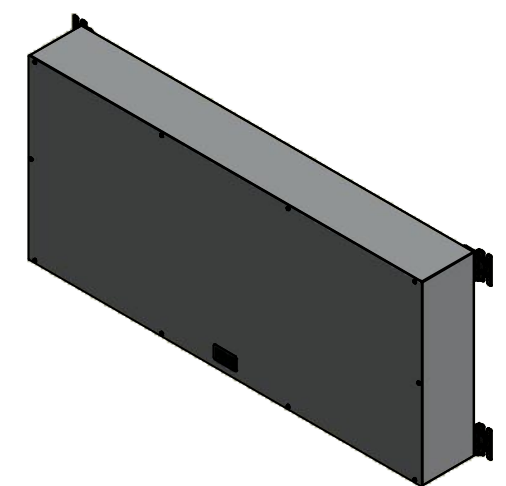

Isometric View

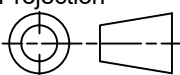

No.	Revisions	Date	By/Par

 Tél: (450) 979-4373 Fax: (450) 979-4626 www.exmweb.com		Flatness Aplatissement Max 3.0mm Projection 
Customer Client	Date	
Drawn By Dessiné Par	BoxCad: BoxCad	Date 2022-08-05
Material Matière	14 Ga Cold Rolled A1008 CS Type B (1.7mm)	
Color Couleur	Asa-61 Grey	Finish Fini Smooth
Description 1100BTCU 1600A - 3Wires x 60" Assembly		Detail Rev.
Part Number Numéro Pièce	1100BTCU051603	Rev. 0

SEE BILL OF MATERIAL ON LAST PAGE

1
8

This drawing is confidential and must not be reproduced or used without the consent of Eurobox

Ce dessin est confidentiel et ne doit pas être reproduit ou utilisé sans le consentement de Eurobox

STANDARD FEATURES ARE NOT LISTED IN THIS HOLE TABLE

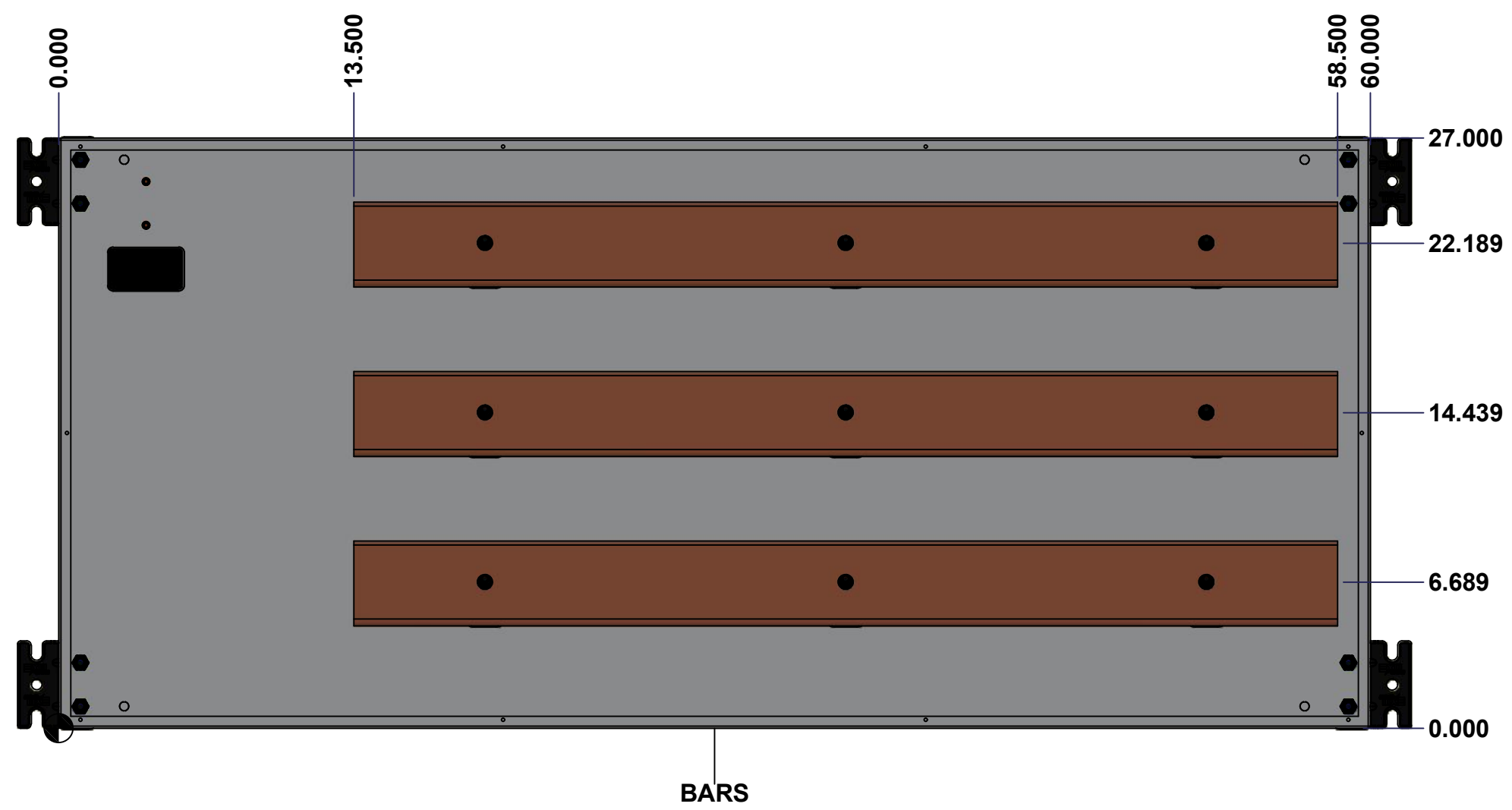

	Description 1100BTCU 1600A - 3Wires x 60" Assembly	Status (NULL)
	Part Number Numéro Pièce 1100BTCU051603	Rev. 2 0 / 8

This drawing is confidential and must not be reproduced or used without the consent of EXM

Ce dessin est confidentiel et ne doit pas être reproduit ou utilisé sans le consentement de EXM

NOTE	
ITEM	DESCRIPTION
1	NEMA 1 Enclosure
2	C/W Standard ground studs on box and cover
3	W/O Standard door stiffener
4	W/O Inner panel
5	W/O Inner panel mounting studs

No.	Revisions	Date	By/Par

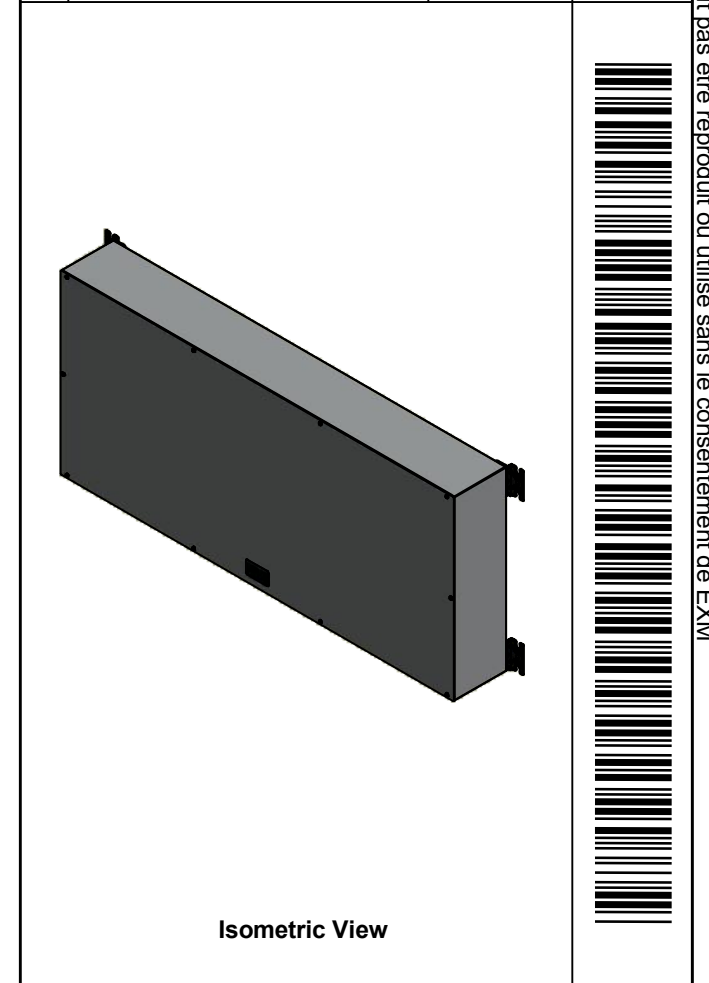

EXM
exm

Tél: (450) 979-4373
Fax: (450) 979-4626
www.exmweb.com

Flatness
Aplatissement
Max 3.0mm

Projection

Customer Client	Date
Drawn By Dessiné Par	Date 2022-08-05

Material Matière	14 Ga Cold Rolled A1008 CS Type B (1.7mm)
---------------------	---

Color Couleur	Asa-61 Grey	Finish Fini	Smooth
------------------	-------------	----------------	--------

Description	Detail Rev.
1100BTCU 1600A - 3Wires x 60" Assembly	

Part Number Numéro Pièce	Rev.	3
1100BTCU051603	0	8

PACKING		
ITEM	QTY	DESCRIPTION
Cardboard sleeve	2	Top and Bottom
Cardboard strip	2	Between back of enclosure and inner panel
Plastic bag	1	To protect cover surface and inside gasket
Cardboard corner	4	To reinforced for the plastic strap tightening
Plastic strap - Black	2	To Squeeze 2 cardboard sleeve together
Packaging label	3	White label with PN
Plastic strap- Green	2	To secure the enclosure to the wood pallet
Wood Pallet	1	2" deeper and 3" larger than enclosure size

Qty	Part Number	Rev	Description
2	885 BTMF	0	885 BTMF Mounting Feet Kit
1	1100BTCU051603BAR2-P	0	Rounded Edge Copper Bar 1/2" x 4"
1	1100BTCU051603BAR1-P	0	Rounded Edge Copper Bar 1/2" x 4"
1	1100BTCU051603BAR3-P	0	Rounded Edge Copper Bar 1/2" x 4"
9	STK-Q-07310	2	Flange Lock Nut M8
9	STK-A-67400	0	Buss Bar Insulator Kit
10	STK-Q-05020	5	M5 x 8mm Thread Rolling Screw
1	1100BTCU051603C	0	1100BTCU 27" x 60" Cover
1	1100BTCU051603B	0	1100BTCU 27" x 60" x 8" Body
Parts List			

This drawing is confidential and must not be reproduced or used without the consent of EXM

Ce dessin est confidentiel et ne doit pas être reproduit ou utilisé sans le consentement de EXM



TOP

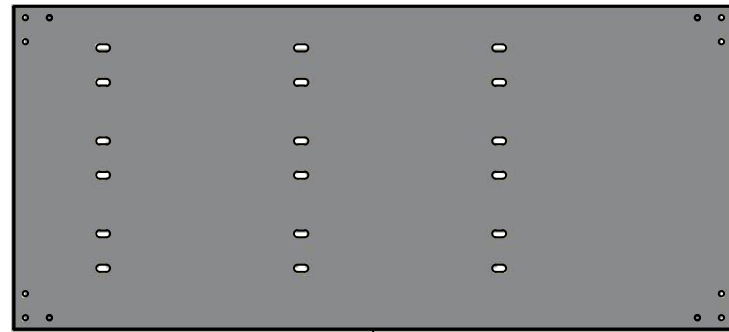

BACK

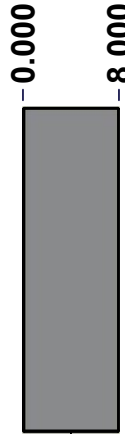

LEFT

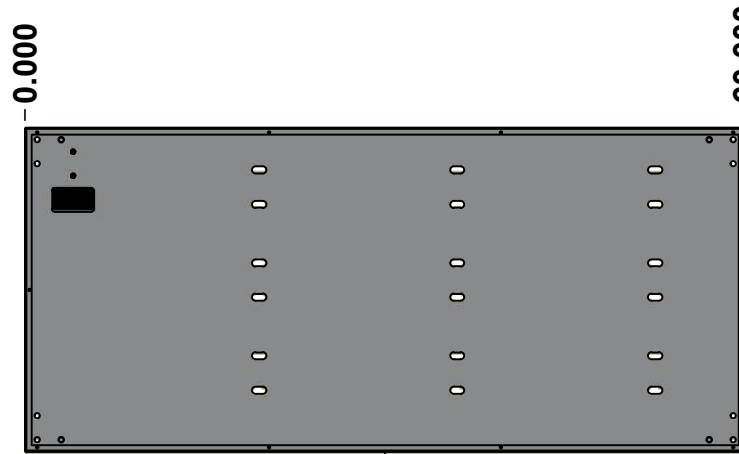

FRONT

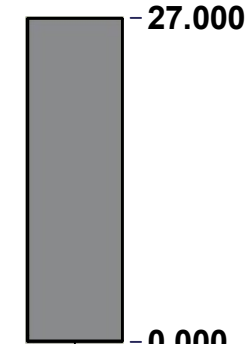

RIGHT



BOTTOM

No.	Revisions	Date	By/Par

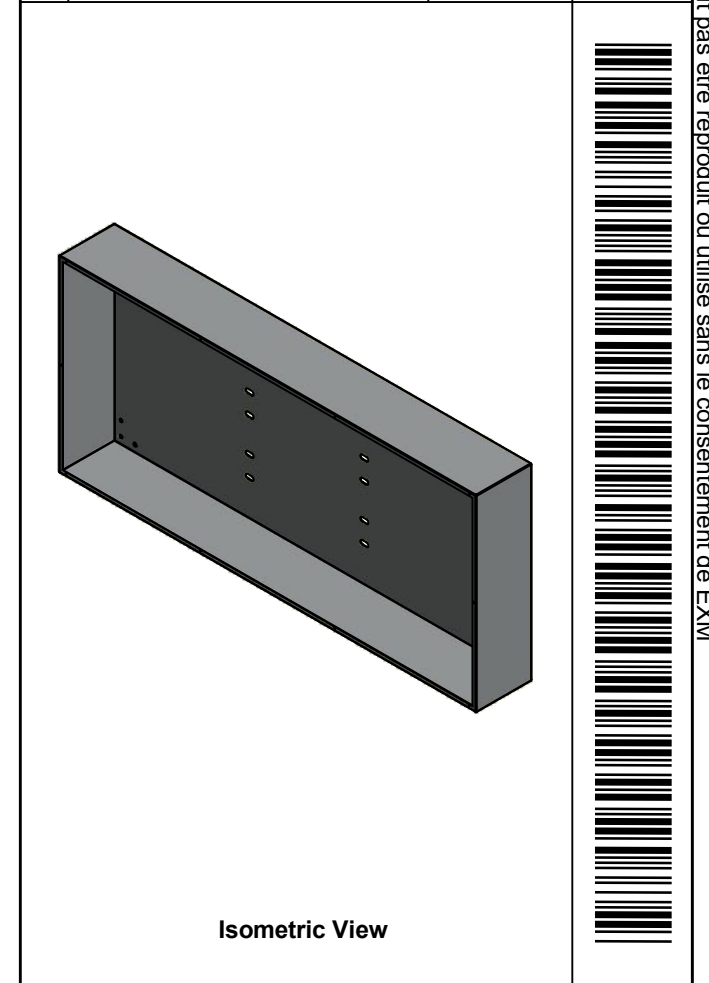

Isometric View

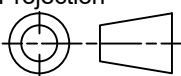
 Tél: (450) 979-4373 Fax: (450) 979-4626 www.exmweb.com		Flatness Aplatissement Max 3.0mm Projection 
Customer Client	Date	
Drawn By Dessiné Par	BoxCad: BoxCad	Date 2022-08-05
Material Matière	14 Ga Cold Rolled A1008 CS Type B (1.7mm)	
Color Couleur	Asa-61 Grey	Finish Fini Smooth
Description	Detail Rev.	
1100BTCU 27" x 60" x 8" Body		
Part Number Numéro Pièce	Rev.	4
1100BTCU051603B	0	8

SEE BILL OF MATERIAL ON LAST PAGE

This drawing is confidential and must not be reproduced or used without the consent of Eurobox

Ce dessin est confidentiel et ne doit pas être reproduit ou utilisé sans le consentement de Eurobox

STANDARD FEATURES ARE NOT LISTED IN THIS HOLE TABLE			
HOLE TABLE - BACK VIEW (CUSTOM FEATURE ONLY)			
CUT-OUT	XDIM	YDIM	DESCRIPTION
1	56.000	25.000	GND STUD M8 x 35mm (Inside)
2	56.000	23.000	GND STUD M8 x 35mm (Inside)

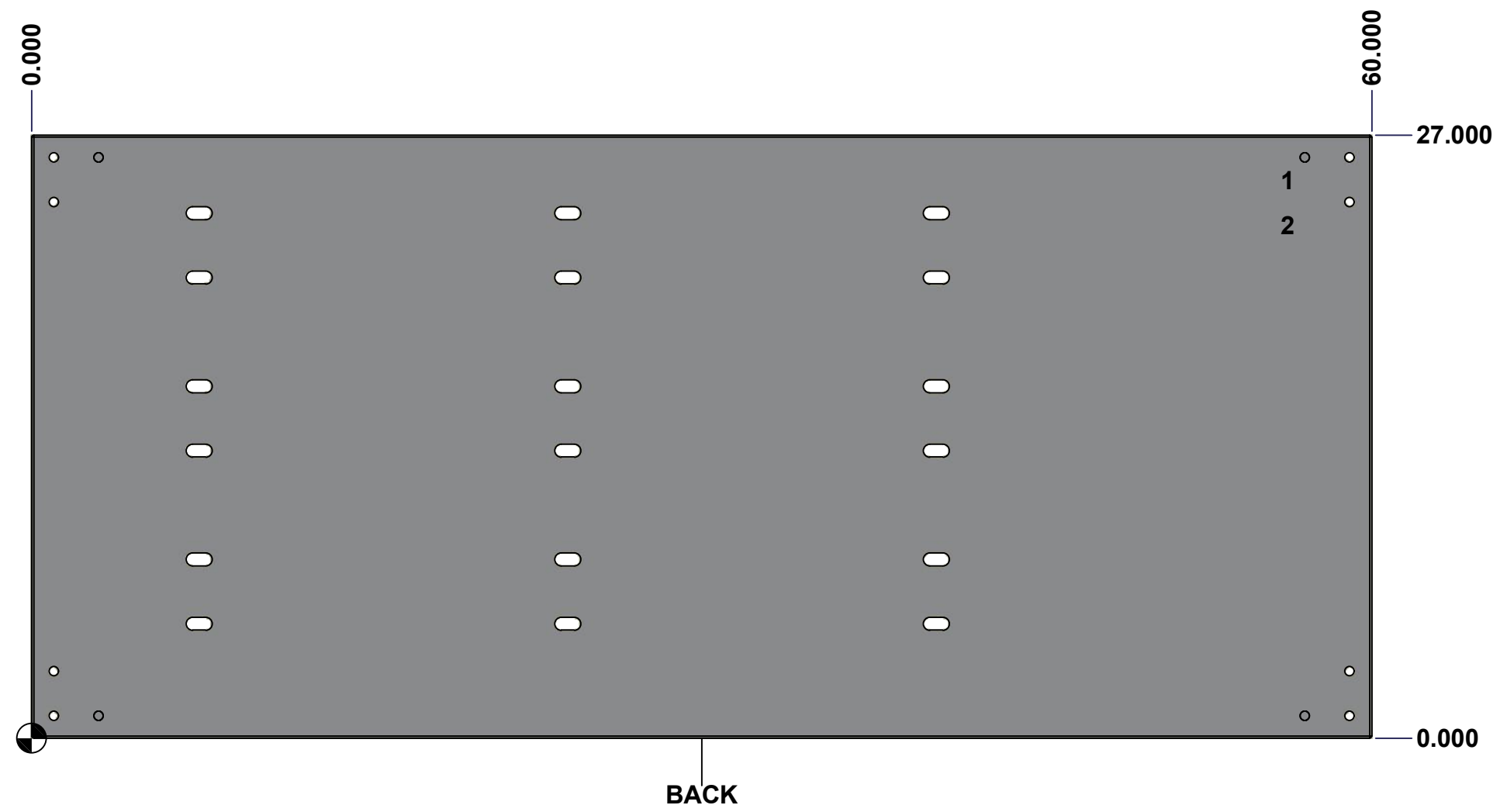



	Description	Status	
	1100BTCU 27" x 60" x 8" Body	(NULL)	
	Part Number Numéro Pièce	Rev.	5
	1100BTCU051603B	0	8

This drawing is confidential and must not be reproduced or used without the consent of EXM

Ce dessin est confidentiel et ne doit pas être reproduit ou utilisé sans le consentement de EXM

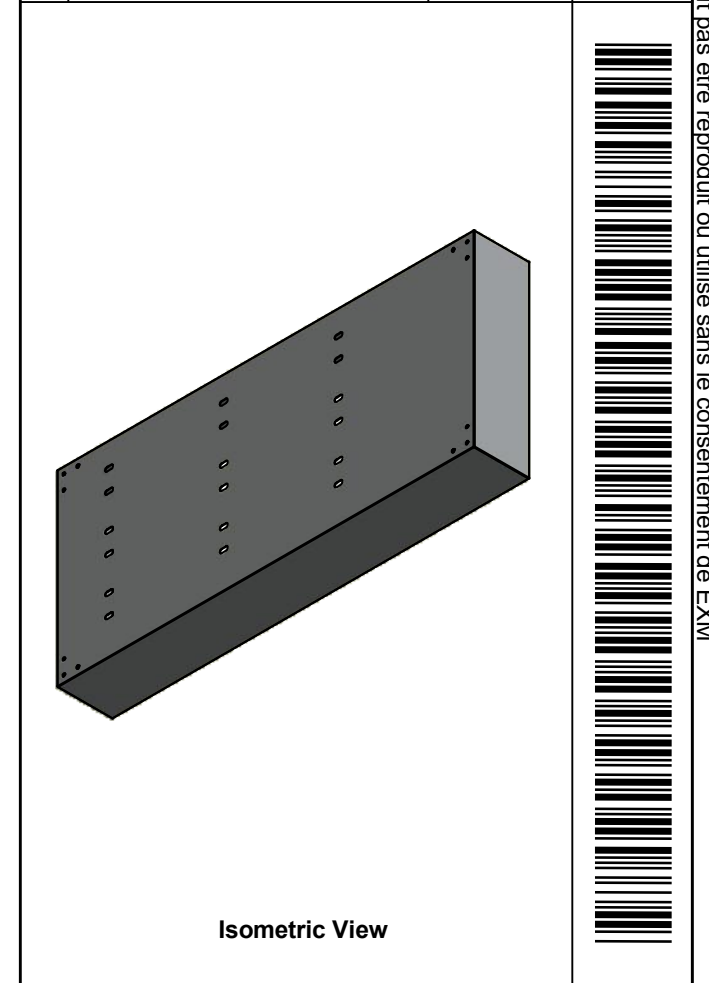
No.	Revisions	Date	By/Par

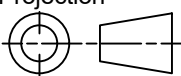

 Tél: (450) 979-4373 Fax: (450) 979-4626 www.exmweb.com		Flatness Aplatissement Max 3.0mm
Customer Client		Projection 
Drawn By / Dessiné Par: BoxCad: BoxCad		Date: 2022-08-05
Material / Matière: 14 Ga Cold Rolled A1008 CS Type B (1.7mm)		
Color / Couleur: Asa-61 Grey	Finish / Fini: Smooth	
Description: 1100BTCU 27" x 60" x 8" Body		Detail Rev.
Part Number / Numéro Pièce: 1100BTCU051603B		Rev. 0 / 6 / 8

Qty	Part Number	Rev	Description
1	STK-P-02400S	0	Powder Paint (Asa-61 Grey / Smooth)
1	STK-S-00100	0	3.5" x 2" Silver Milar Flexcon Sticker
2	STK-Q-16005	1	Stud M8 x 35 (No Paint Cap Required)
1	1100BTCU051603B-P	0	1100BTCU 27" x 60" x 8" Body Part
Parts List			

This drawing is confidential and must not be reproduced or used without the consent of EXM

Ce dessin est confidentiel et ne doit pas être reproduit ou utilisé sans le consentement de EXM

TOP

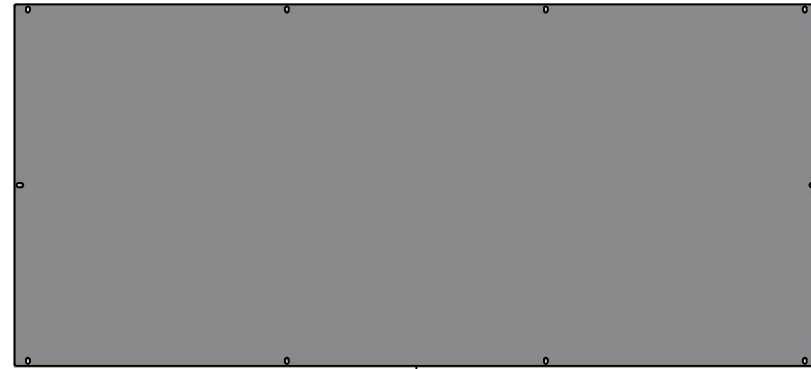

BACK

LEFT

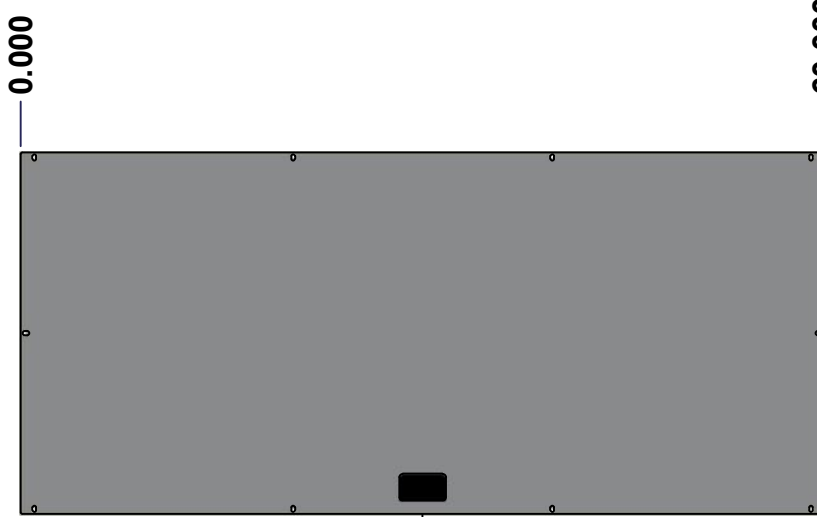

FRONT

RIGHT

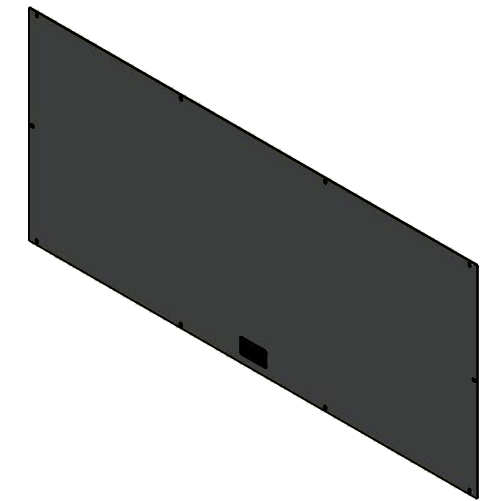

Isometric View



Tél: (450) 979-4373
 Fax: (450) 979-4626
www.exmweb.com

Flatness
Aplatissement

Max 3.0mm

Projection

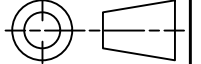

Customer Client	Date
Drawn By / Dessiné Par: BoxCad: BoxCad	Date: 2022-08-05
Material / Matière: 14 Ga Cold Rolled A1008 CS Type B (1.7mm)	

Color / Couleur: Asa-61 Grey	Finish / Fini: Smooth
------------------------------	-----------------------

Description: 1100BTCU 27" x 60" Cover	Detail Rev.
---------------------------------------	-------------

Part Number / Numéro Pièce: 1100BTCU051603C	Rev. 0	7	8
---	--------	---	---

SEE BILL OF MATERIAL ON LAST PAGE

This drawing is confidential and must not be reproduced or used without the consent of EXM

Ce dessin est confidentiel et ne doit pas être reproduit ou utilisé sans le consentement de EXM

No.	Revisions	Date	By/Par

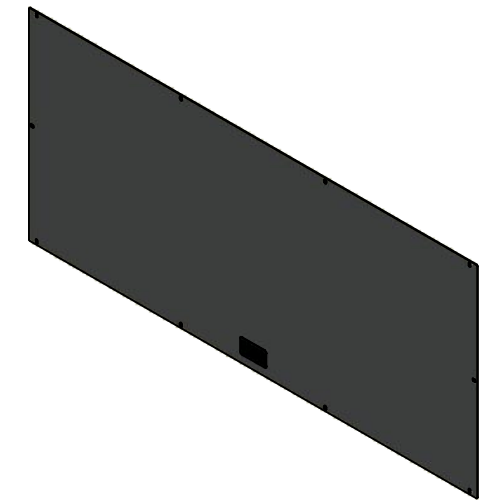

Isometric View

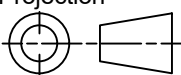

 Tél: (450) 979-4373 Fax: (450) 979-4626 www.exmweb.com		Flatness Aplatissement Max 3.0mm Projection 
Customer Client	Date	
Drawn By Dessiné Par	BoxCad: BoxCad	Date 2022-08-05
Material Matière	14 Ga Cold Rolled A1008 CS Type B (1.7mm)	
Color Couleur	Asa-61 Grey	Finish Fini Smooth
Description		Detail Rev.
1100BTCU 27" x 60" Cover		
Part Number Numéro Pièce	Rev.	8
1100BTCU051603C	0	8

Qty	Part Name	Rev	Description
1	STK-P-02400S	0	Powder Paint (Asa-61 Grey / Smooth)
1	STK-S-00100	0	3.5" x 2" Silver Milar Flexcon Sticker
1	1100BTCU051603C-P	0	1100BTCU 27" x 60" Flat Cover Part
Parts List			