

This drawing is confidential and must not be reproduced or used without the consent of EXM

Ce dessin est confidentiel et ne doit pas être reproduit ou utilisé sans le consentement de EXM

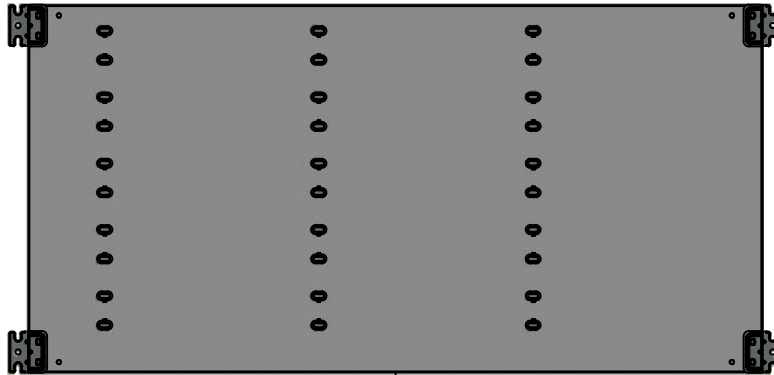

TOP



BACK

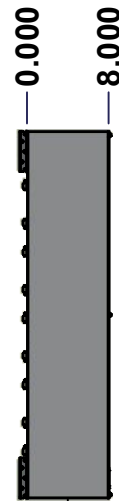

LEFT

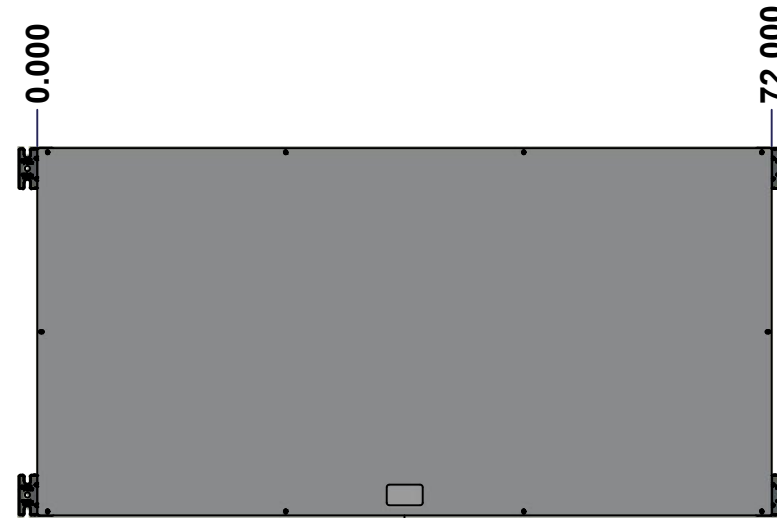

FRONT

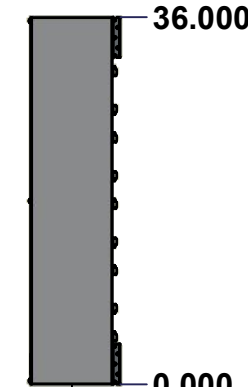

RIGHT



BOTTOM

No.	Revisions	Date	By/Par

**Isometric View**

Tél: (450) 979-4373 Fax: (450) 979-4626 <a href="http://www.exmweb.com">www.exmweb.com</a>		Flatness Aplatissement	
		Max 3.0mm	
Projection			
Customer Client		Date	
Drawn By Dessiné Par BoxCad: BoxCad		Date 04-Aug-22	
Material Matière 14 Ga Cold Rolled A1008 CS Type B (1.7mm)			
Color Couleur Asa-61 Grey		Finish Fini Smooth	
Description 1100BTCU 1000A - 5Wires x 72" Assembly			Detail Rev.
Part Number Numéro Pièce <b>1100BTCU061005</b>		Rev. <b>0</b>	1 8

SEE BILL OF MATERIAL ON LAST PAGE

This drawing is confidential and must not be reproduced or used without the consent of Eurobox

**STANDARD FEATURES ARE NOT LISTED IN THIS HOLE TABLE**

Ce dessin est confidentiel et ne doit pas être reproduit ou utilisé sans le consentement de Eurobox

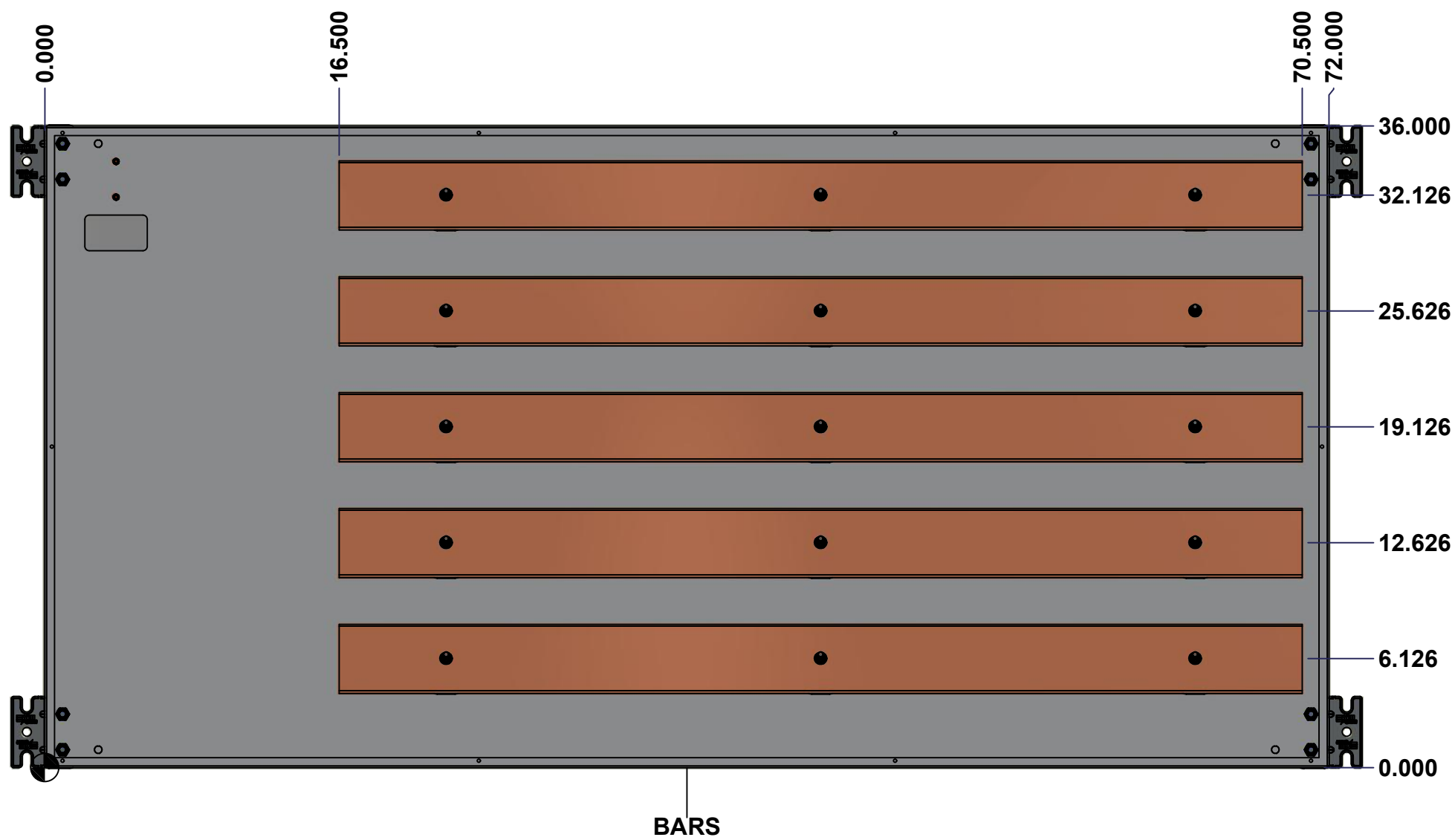

	Description		Status	
	1100BTCU 1000A - 5Wires x 72" Assembly		(NULL)	
Part Number		Rev.	2	
Numéro Pièce		<b>0</b>	8	
<b>1100BTCU061005</b>				

This drawing is confidential and must not be reproduced or used without the consent of EXM

Ce dessin est confidentiel et ne doit pas être reproduit ou utilisé sans le consentement de EXM

**NOTE**

ITEM	DESCRIPTION
1	NEMA 1 Enclosure
2	C/W Standard ground studs on box and cover
3	W/O Standard door stiffener
4	W/O Inner panel
5	W/O Inner panel mounting studs

No.	Revisions	Date	By/Par

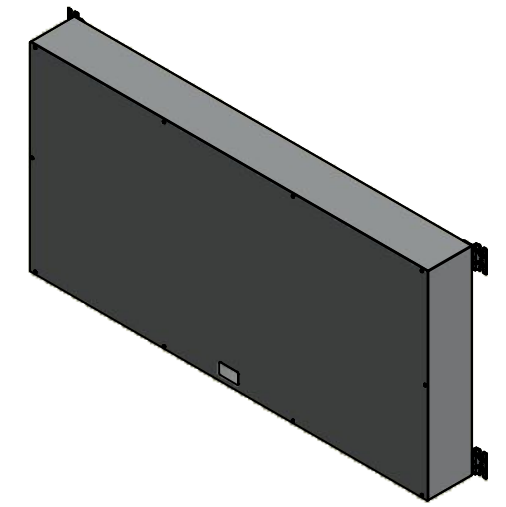

Isometric View



Tél: (450) 979-4373  
 Fax: (450) 979-4626  
[www.exmweb.com](http://www.exmweb.com)

Flatness  
Aplatissement  
Max 3.0mm  
Projection

Customer Client	Date
Drawn By Dessiné Par BoxCad: BoxCad	Date 04-Aug-22
Material Matière 14 Ga Cold Rolled A1008 CS Type B (1.7mm)	
Color Couleur Asa-61 Grey	Finish Fini Smooth
Description 1100BTCU 1000A - 5Wires x 72" Assembly	Detail Rev.
Part Number Numéro Pièce <b>1100BTCU061005</b>	Rev. 0

Qty	Part Number	Rev	Description
2	885 BTMF	0	885 BTMF Mounting Feet Kit
1	1100BTCU061005BAR4-P	0	Rounded Edge Copper Bar 1/4" x 4"
1	1100BTCU061005BAR3-P	0	Rounded Edge Copper Bar 1/4" x 4"
1	1100BTCU061005BAR2-P	0	Rounded Edge Copper Bar 1/4" x 4"
1	1100BTCU061005BAR1-P	0	Rounded Edge Copper Bar 1/4" x 4"
1	1100BTCU061005BAR5-P	0	Rounded Edge Copper Bar 1/4" x 4"
15	STK-Q-07310	2	Flange Lock Nut M8
15	STK-A-67400	0	Buss Bar Insulator Kit
10	STK-Q-05020	5	M5 x 8mm Thread Rolling Screw
1	1100BTCU061005C	0	1100BTCU 36" x 72" Cover
1	1100BTCU061005B	0	1100BTCU 36" x 72" x 8" Body
Parts List			

**PACKING**

ITEM	QTY	DESCRIPTION
Cardboard sleeve	2	Top and Bottom
Cardboard strip	2	Between back of enclosure and inner panel
Plastic bag	1	To protect cover surface and inside gasket
Cardboard corner	4	To reinforced for the plastic strap tightening
Plastic strap - Black	2	To Squeeze 2 cardboard sleeve together
Packaging label	3	White label with PN
Plastic strap- Green	2	To secure the enclosure to the wood pallet
Wood Pallet	1	2" deeper and 3" larger than enclosure size

This drawing is confidential and must not be reproduced or used without the consent of EXM

Ce dessin est confidentiel et ne doit pas être reproduit ou utilisé sans le consentement de EXM



TOP

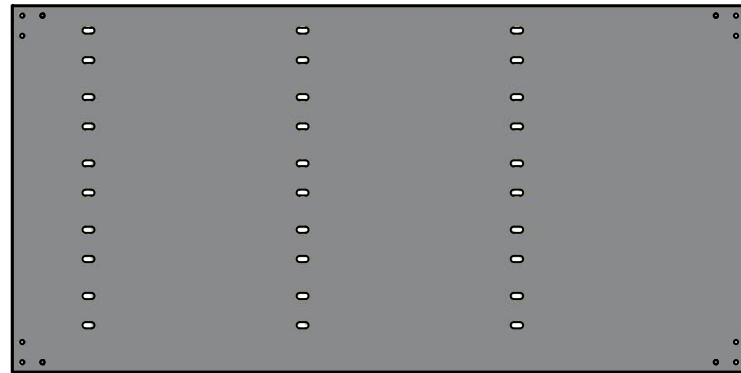

BACK

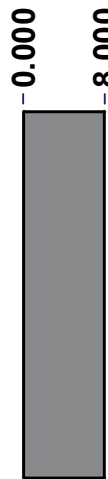

LEFT

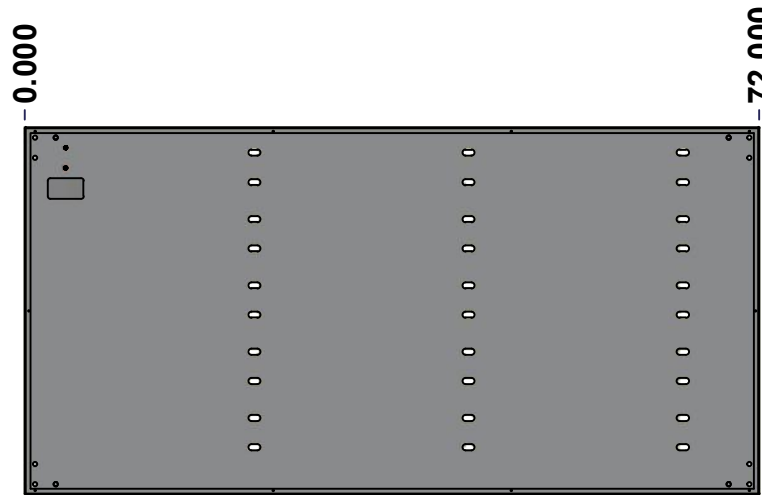

FRONT

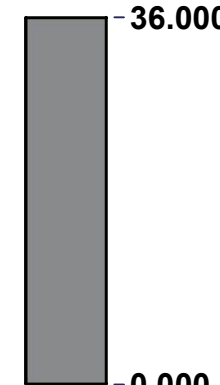

RIGHT



BOTTOM

No.	Revisions	Date	By/Par

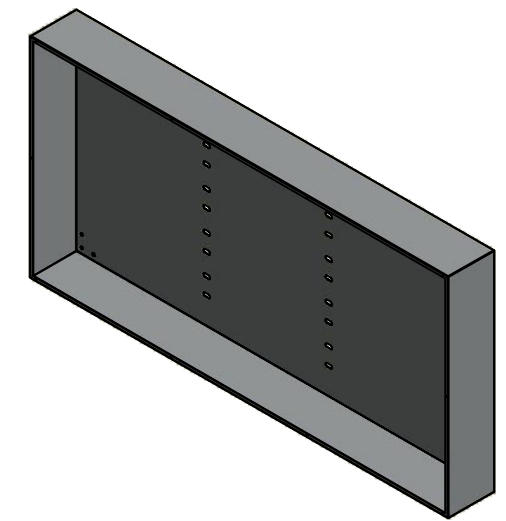

Isometric View

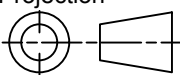

 Tél: (450) 979-4373 Fax: (450) 979-4626 <a href="http://www.exmweb.com">www.exmweb.com</a>	Flatness Aplatissement Max 3.0mm
	Projection 
Customer Client	Date
Drawn By Dessiné Par BoxCad: BoxCad	Date 04-Aug-22
Material Matière 14 Ga Cold Rolled A1008 CS Type B (1.7mm)	
Color Couleur Asa-61 Grey	Finish Fini Smooth
Description 1100BTCU 36" x 72" x 8" Body	Detail Rev.
Part Number Numéro Pièce <b>1100BTCU061005B</b>	Rev. 4 <b>0</b>

SEE BILL OF MATERIAL ON LAST PAGE

This drawing is confidential and must not be reproduced or used without the consent of Eurobox

Ce dessin est confidentiel et ne doit pas être reproduit ou utilisé sans le consentement de Eurobox

STANDARD FEATURES ARE NOT LISTED IN THIS HOLE TABLE			
HOLE TABLE - BACK VIEW (CUSTOM FEATURE ONLY)			
CUT-OUT	XDIM	YDIM	DESCRIPTION
1	68.000	34.000	GND STUD M8 x 35mm (Inside)
2	68.000	32.000	GND STUD M8 x 35mm (Inside)

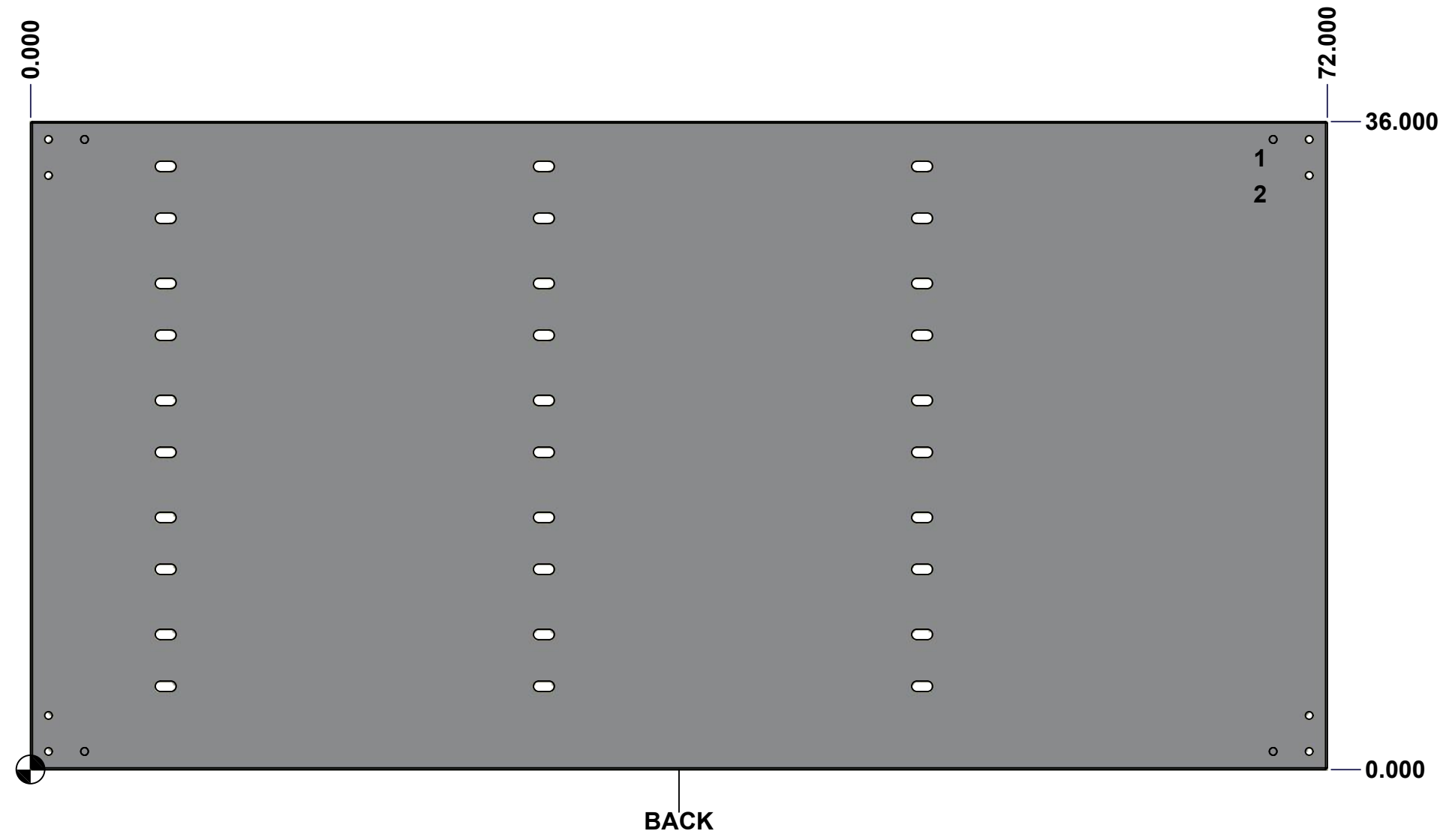



	Description	Status
	1100BTCU 36" x 72" x 8" Body	(NULL)
Part Number Numéro Pièce <b>1100BTCU061005B</b>	Rev.	5
	<b>0</b>	8

This drawing is confidential and must not be reproduced or used without the consent of EXM

Ce dessin est confidentiel et ne doit pas être reproduit ou utilisé sans le consentement de EXM

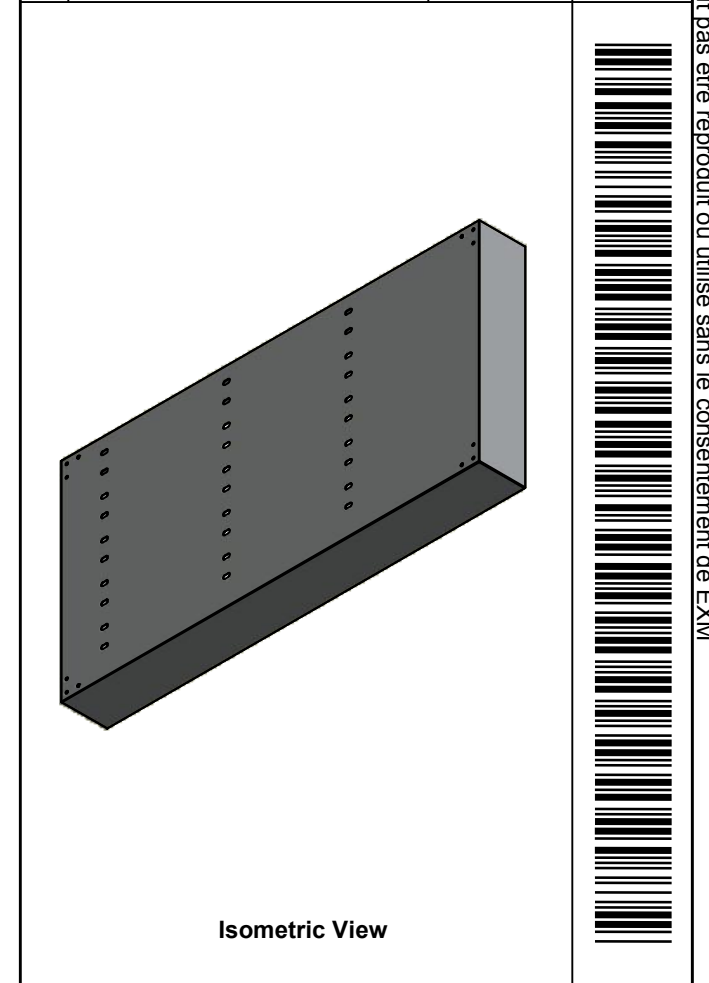
No.	Revisions	Date	By/Par

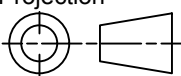

 Tél: (450) 979-4373 Fax: (450) 979-4626 <a href="http://www.exmweb.com">www.exmweb.com</a>		Flatness Aplatissement Max 3.0mm
Customer Client		Projection 
Drawn By / Dessiné Par: BoxCad: BoxCad		Date: 04-Aug-22
Material / Matière: 14 Ga Cold Rolled A1008 CS Type B (1.7mm)		
Color / Couleur: Asa-61 Grey	Finish / Fini: Smooth	
Description: 1100BTCU 36" x 72" x 8" Body		Detail Rev.
Part Number / Numéro Pièce: <b>1100BTCU061005B</b>		Rev. 0 / 6 / 8

Qty	Part Number	Rev	Description
1	STK-P-02400S	0	Powder Paint (Asa-61 Grey / Smooth)
1	STK-S-00100	0	3.5" x 2" Silver Milar Flexcon Sticker
2	STK-Q-16005	1	Stud M8 x 35 (No Paint Cap Required)
1	1100BTCU061005B-P	0	1100BTCU 36" x 72" x 8" Body Part
Parts List			

This drawing is confidential and must not be reproduced or used without the consent of EXM

Ce dessin est confidentiel et ne doit pas être reproduit ou utilisé sans le consentement de EXM

TOP

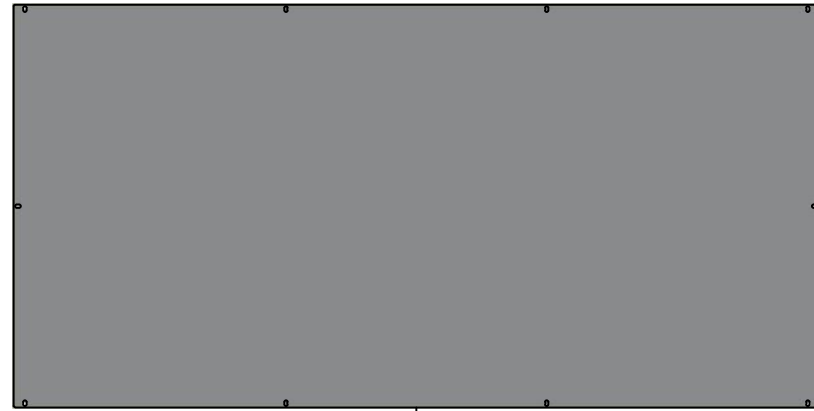

BACK

LEFT

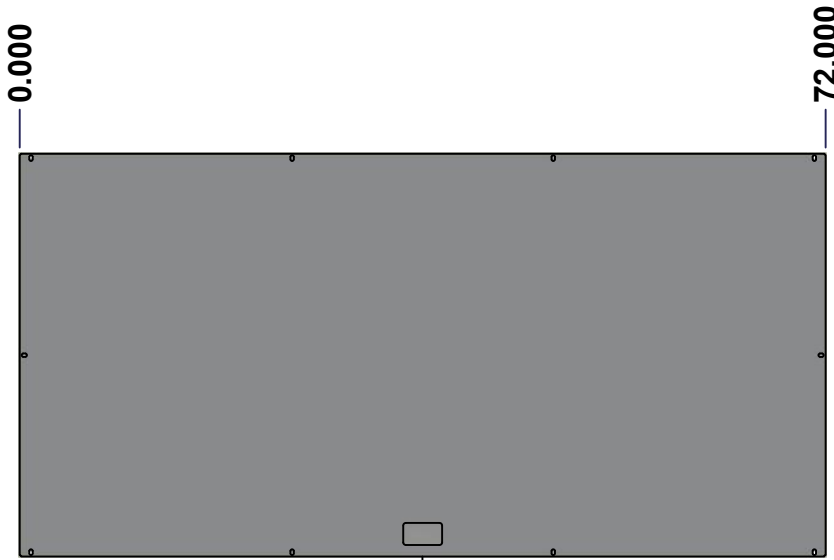

FRONT

RIGHT

BOTTOM

No.	Revisions	Date	By/Par

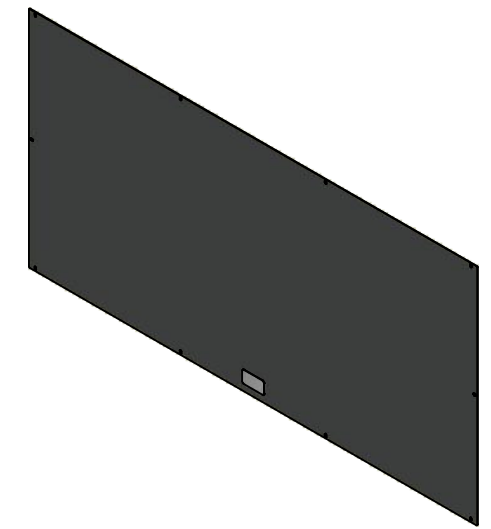

Isometric View



Tél: (450) 979-4373  
 Fax: (450) 979-4626  
[www.exmweb.com](http://www.exmweb.com)

Flatness  
Aplatissement

Max 3.0mm

Projection

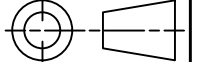

Customer Client	Date
Drawn By / Dessiné Par: BoxCad: BoxCad	Date: 04-Aug-22
Material / Matière: 14 Ga Cold Rolled A1008 CS Type B (1.7mm)	
Color / Couleur: Asa-61 Grey	Finish / Fini: Smooth
Description: 1100BTCU 36" x 72" Cover	Detail Rev.
Part Number / Numéro Pièce: 1100BTCU061005C	Rev. 7
	8

SEE BILL OF MATERIAL ON LAST PAGE

This drawing is confidential and must not be reproduced or used without the consent of EXM

Ce dessin est confidentiel et ne doit pas être reproduit ou utilisé sans le consentement de EXM

No.	Revisions	Date	By/Par

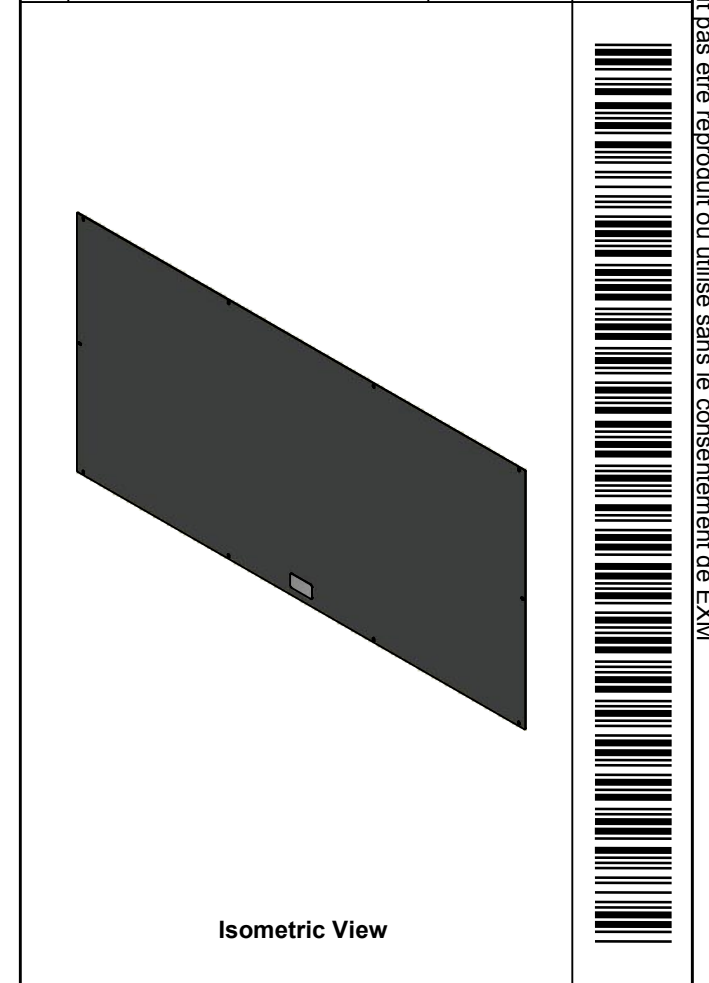

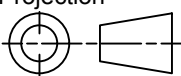
 Tél: (450) 979-4373 Fax: (450) 979-4626 <a href="http://www.exmweb.com">www.exmweb.com</a>		Flatness Aplatissement Max 3.0mm
Customer Client		Projection 
Drawn By / Dessiné Par: BoxCad: BoxCad		Date: 04-Aug-22
Material / Matière: 14 Ga Cold Rolled A1008 CS Type B (1.7mm)		
Color / Couleur: Asa-61 Grey	Finish / Fini: Smooth	
Description: 1100BTCU 36" x 72" Cover		Detail Rev.
Part Number / Numéro Pièce: <b>1100BTCU061005C</b>		Rev. 8 <b>0</b>

Qty	Part Name	Rev	Description
1	STK-P-02400S	0	Powder Paint (Asa-61 Grey / Smooth)
1	STK-S-00100	0	3.5" x 2" Silver Milar Flexcon Sticker
1	1100BTCU061005C-P	0	1100BTCU 36" x 72" Flat Cover Part
Parts List			