

This drawing is confidential and must not be reproduced or used without the consent of EXM

Ce dessin est confidentiel et ne doit pas être reproduit ou utilisé sans le consentement de EXM

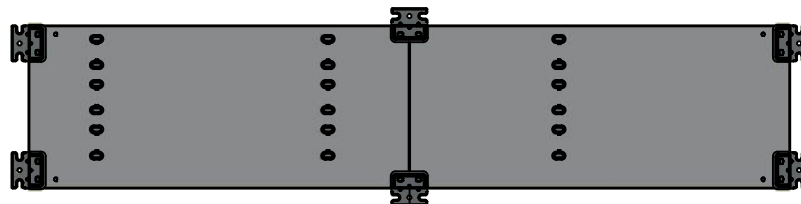

TOP



BACK

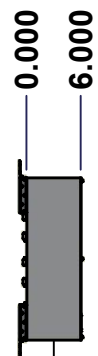

LEFT

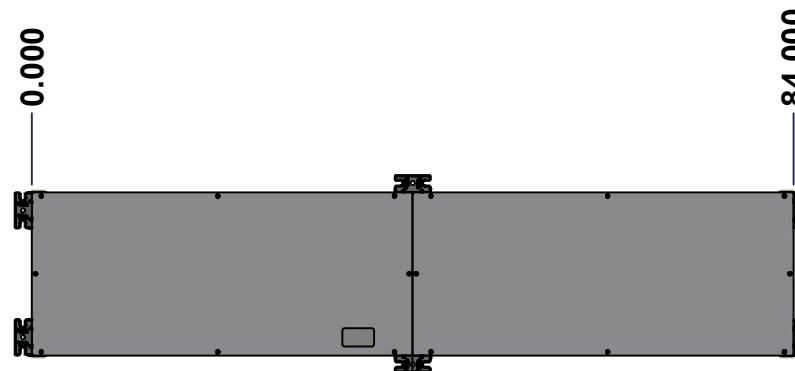

FRONT

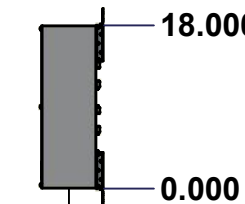

RIGHT



BOTTOM

No.	Revisions	Date	By/Par

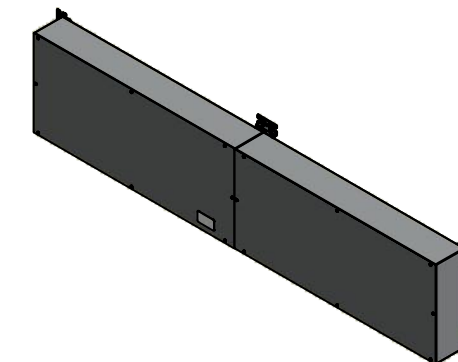

Isometric View

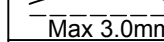
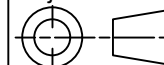

 Tél: (450) 979-4373 Fax: (450) 979-4626 www.exmweb.com		Flatness Aplatissement  Max 3.0mm Projection 
Customer Client	Date	
Drawn By Dessiné Par	BoxCad: BoxCad	Date 01-Aug-22
Material Matière	14 Ga Cold Rolled A1008 CS Type B (1.7mm)	
Color Couleur	Asa-61 Grey	Finish Fini Smooth
Description	Detail Rev.	
1100BTCU 225A - 3Wires x 84" Assembly		
Part Number Numéro Pièce	Rev. 0	1 / 8
1100BTCU07203		

SEE BILL OF MATERIAL ON LAST PAGE

This drawing is confidential and must not be reproduced or used without the consent of Eurobox

Ce dessin est confidentiel et ne doit pas être reproduit ou utilisé sans le consentement de Eurobox

STANDARD FEATURES ARE NOT LISTED IN THIS HOLE TABLE

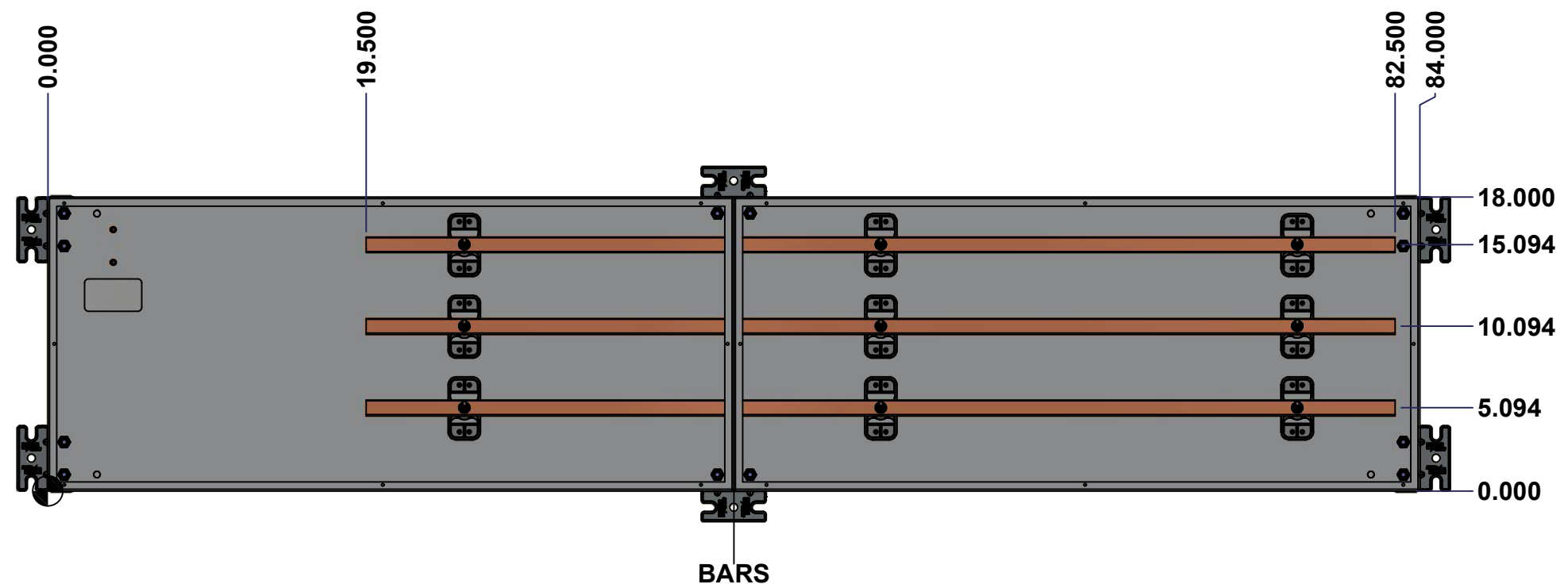

	Description	Status	
	1100BTCU 225A - 3Wires x 84" Assembly	(NULL)	
	Part Number Numéro Pièce	Rev.	
	1100BTCU07203	0	2 8

This drawing is confidential and must not be reproduced or used without the consent of EXM

Ce dessin est confidentiel et ne doit pas être reproduit ou utilisé sans le consentement de EXM

NOTE	
ITEM	DESCRIPTION
1	NEMA 1 Enclosure
2	C/W Standard ground studs on box and cover
3	W/O Standard door stiffener
4	W/O Inner panel
5	W/O Inner panel mounting studs

No.	Revisions	Date	By/Par

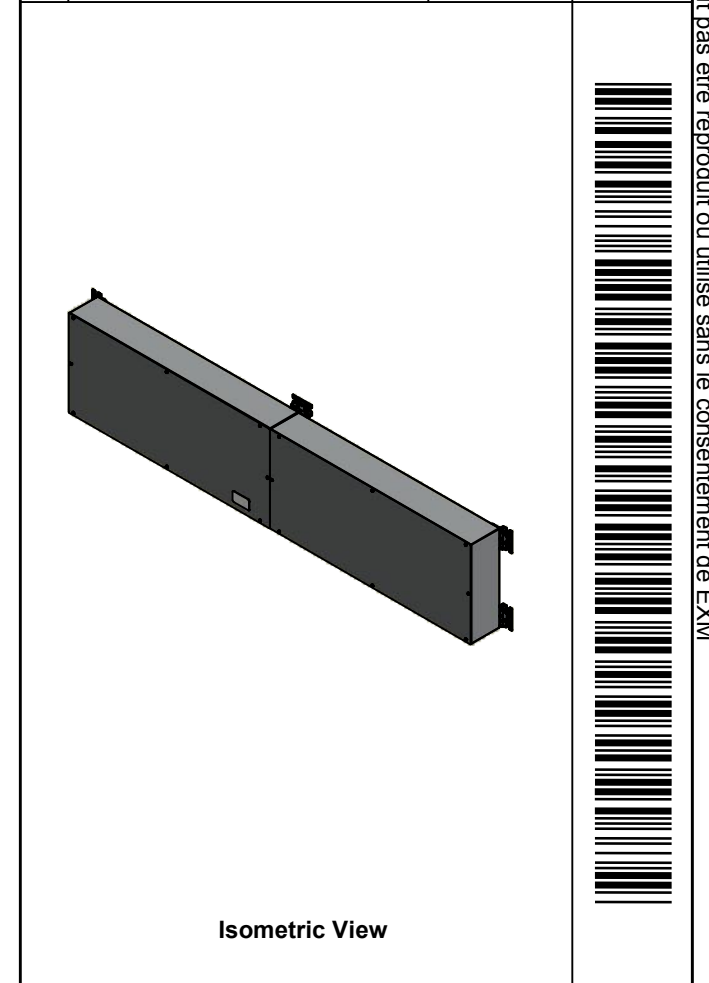

EXM
www.exmweb.com

Tél: (450) 979-4373
Fax: (450) 979-4626

Flatness
Aplatissement
Max 3.0mm

Projection

PACKING		
ITEM	QTY	DESCRIPTION
Cardboard sleeve	2	Top and Bottom
Cardboard strip	2	Between back of enclosure and inner panel
Plastic bag	1	To protect cover surface and inside gasket
Cardboard corner	4	To reinforced for the plastic strap tightening
Plastic strap - Black	2	To Squeeze 2 cardboard sleeve together
Packaging label	3	White label with PN
Plastic strap- Green	2	To secure the enclosure to the wood pallet
Wood Pallet	1	2" deeper and 3" larger than enclosure size

1	1100BTCU07203BAR3-P	0	Rounded Edge Copper Bar 1/8" x 1"
1	1100BTCU07203BAR2-P	0	Rounded Edge Copper Bar 1/8" x 1"
1	1100BTCU07203BAR1-P	0	Rounded Edge Copper Bar 1/8" x 1"
9	STK-Q-07310	2	Flange Lock Nut M8
9	STK-A-67400	0	Buss Bar Insulator Kit
10	STK-Q-03210	0	Thread Cutting Screw 1/4-20 x 5/16"
16	STK-Q-05020	5	M5 x 8mm Thread Rolling Screw
1	1100BTCU07203C	0	1100BTCU 18" x 84" Cover
1	1100BTCU07203B	0	1100BTCU 18" x 84" x 6" Body
3	885 BTMF	0	885 BTMF Mounting Feet Kit
Qty	Part Number	Rev	Description
Parts List			

Customer Client

Drawn By
Dessiné Par BoxCad: BoxCad

Material
Matière 14 Ga Cold Rolled A1008 CS Type B (1.7mm)

Color
Couleur Asa-61 Grey

Finish
Fini Smooth

Description
1100BTCU 225A - 3Wires x 84" Assembly

Part Number
Numéro Pièce **1100BTCU07203**

Date 01-Aug-22

Detail Rev.

Rev.	3
	8

This drawing is confidential and must not be reproduced or used without the consent of EXM

Ce dessin est confidentiel et ne doit pas être reproduit ou utilisé sans le consentement de EXM



TOP

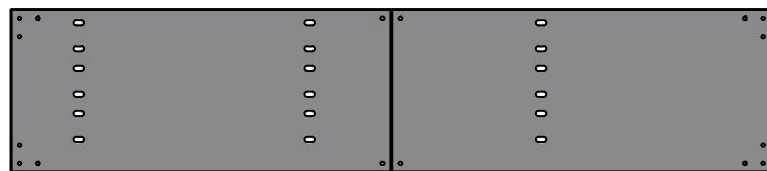

BACK

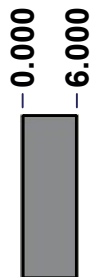

LEFT

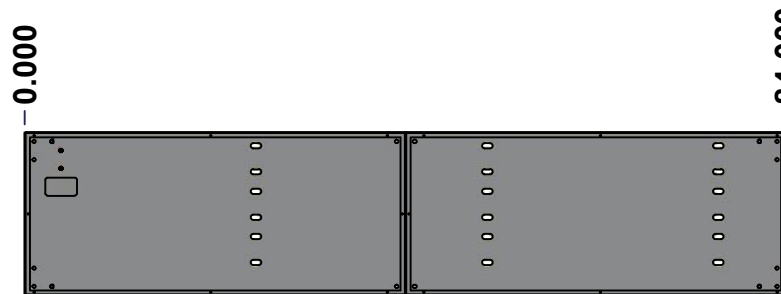

FRONT

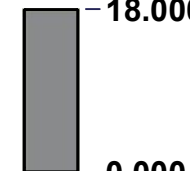

RIGHT



BOTTOM

No.	Revisions	Date	By/Par

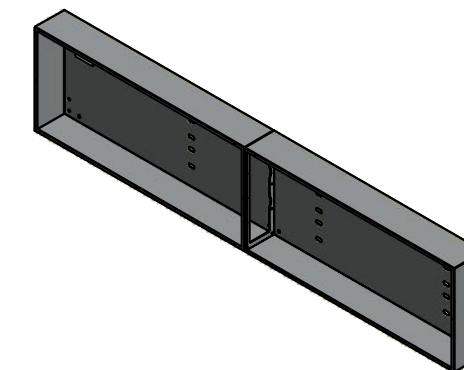

Isometric View



Tél: (450) 979-4373
 Fax: (450) 979-4626
www.exmweb.com

Flatness
Aplatissement

Max 3.0mm

Projection



Customer Client	Date
Drawn By Dessiné Par BoxCad: BoxCad	Date 01-Aug-22
Material Matière 14 Ga Cold Rolled A1008 CS Type B (1.7mm)	
Color Couleur Asa-61 Grey	Finish Fini Smooth
Description 1100BTCU 18" x 84" x 6" Body	Detail Rev.
Part Number Numéro Pièce 1100BTCU07203B	Rev. 4 0

SEE BILL OF MATERIAL ON LAST PAGE

This drawing is confidential and must not be reproduced or used without the consent of Eurobox

Ce dessin est confidentiel et ne doit pas être reproduit ou utilisé sans le consentement de Eurobox

STANDARD FEATURES ARE NOT LISTED IN THIS HOLE TABLE			
HOLE TABLE - BACK VIEW (CUSTOM FEATURE ONLY)			
CUT-OUT	XDIM	YDIM	DESCRIPTION
1	80.000	16.000	GND STUD M8 x 35mm (Inside)
2	80.000	14.000	GND STUD M8 x 35mm (Inside)

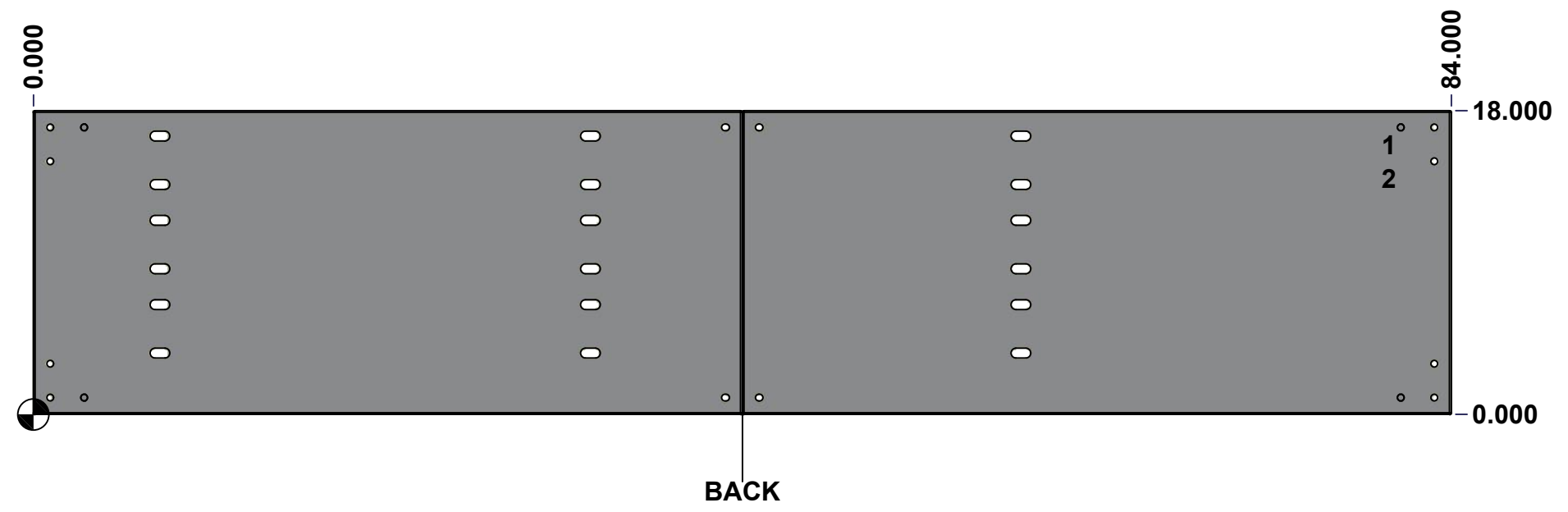

	Description	Status	
	1100BTCU 18" x 84" x 6" Body	(NULL)	
	Part Number Numéro Pièce	Rev.	
	1100BTCU07203B	0	5 8

This drawing is confidential and must not be reproduced or used without the consent of EXM

Ce dessin est confidentiel et ne doit pas être reproduit ou utilisé sans le consentement de EXM

No.	Revisions	Date	By/Par

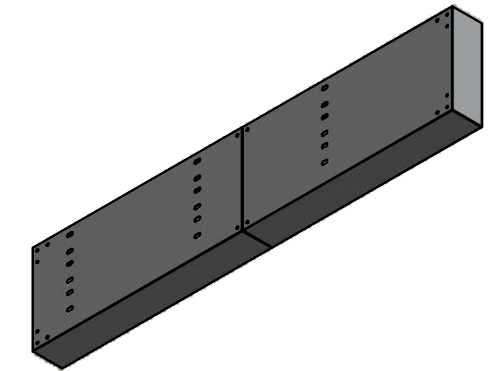

Isometric View



Tél: (450) 979-4373
 Fax: (450) 979-4626
www.exmweb.com

Flatness
Aplatissement

Max 3.0mm

Projection

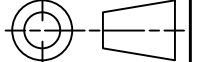

Customer Client	Date
Drawn By / Dessiné Par: BoxCad: BoxCad	Date: 01-Aug-22
Material / Matière: 14 Ga Cold Rolled A1008 CS Type B (1.7mm)	

Color / Couleur: Asa-61 Grey	Finish / Fini: Smooth
------------------------------	-----------------------

Description: 1100BTCU 18" x 84" x 6" Body	Detail Rev.
---	-------------

Part Number / Numéro Pièce: 1100BTCU07203B	Rev. 0	6 / 8
---	--------	-------

Qty	Part Number	Rev	Description
1	STK-P-02400S	0	Powder Paint (Asa-61 Grey / Smooth)
1	1100BTCU07203B-P	0	1100BTCU 18" x 84" x 6" Body Part
1	STK-S-00100	0	3.5" x 2" Silver Milar Flexcon Sticker
2	STK-Q-16005	1	Stud M8 x 35 (No Paint Cap Required)
1	1100BTCU07203E-P	0	1100BTCU 18" x 84" x 6" Body Part
Parts List			

This drawing is confidential and must not be reproduced or used without the consent of EXM

Ce dessin est confidentiel et ne doit pas être reproduit ou utilisé sans le consentement de EXM

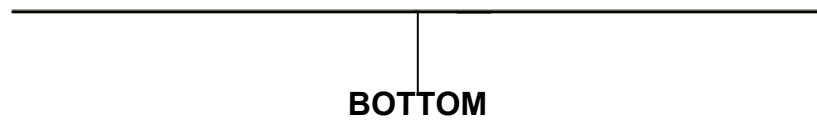
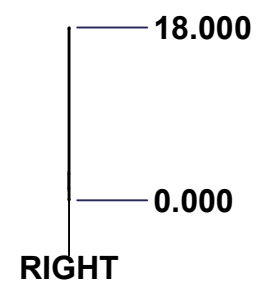
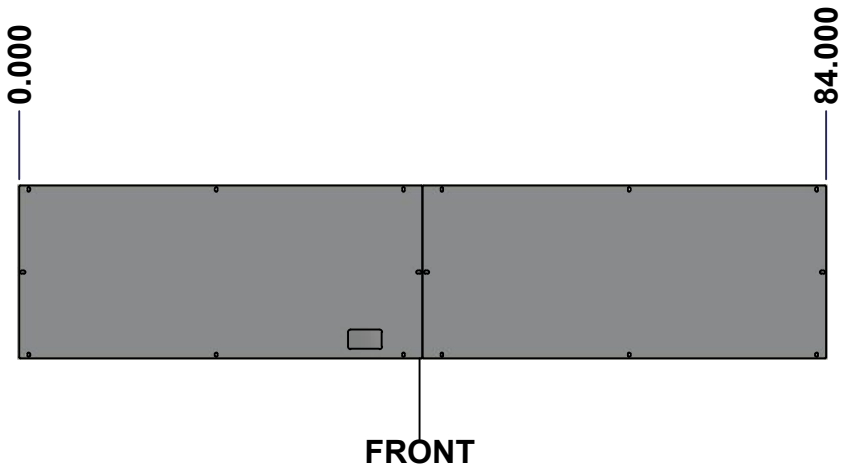
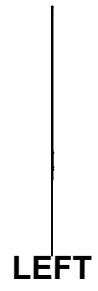
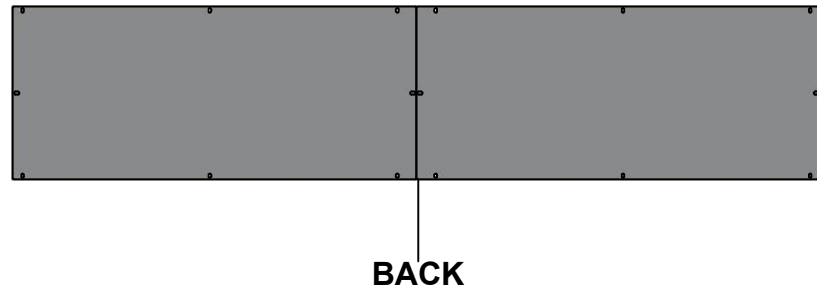
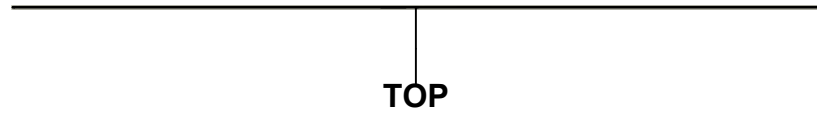

No.	Revisions	Date	By/Par

Isometric View

Tél: (450) 979-4373 Fax: (450) 979-4626 www.exmweb.com		Flatness Aplatissement
		Max 3.0mm
Projection		
Customer Client		Date
Drawn By Dessiné Par	BoxCad: BoxCad	Date 01-Aug-22
Material Matière	14 Ga Cold Rolled A1008 CS Type B (1.7mm)	
Color Couleur	Asa-61 Grey	Finish Fini Smooth
Description		Detail Rev.
1100BTCU 18" x 84" Cover		
Part Number Numéro Pièce	Rev.	7
1100BTCU07203C	0	8

SEE BILL OF MATERIAL ON LAST PAGE

This drawing is confidential and must not be reproduced or used without the consent of EXM

Ce dessin est confidentiel et ne doit pas être reproduit ou utilisé sans le consentement de EXM

No.	Revisions	Date	By/Par

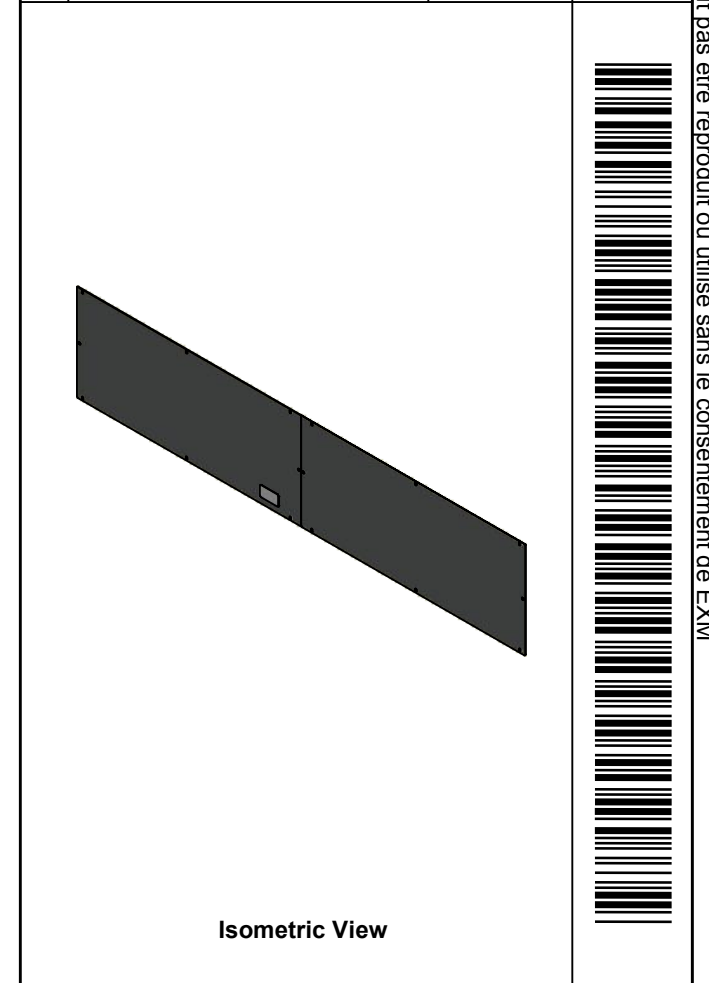

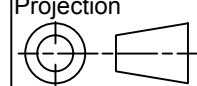
 Tél: (450) 979-4373 Fax: (450) 979-4626 www.exmweb.com		Flatness Aplatissement Max 3.0mm Projection 
Customer Client	Date	
Drawn By / Dessiné Par: BoxCad: BoxCad	Date: 01-Aug-22	
Material / Matière: 14 Ga Cold Rolled A1008 CS Type B (1.7mm)		
Color / Couleur: Asa-61 Grey	Finish / Fini: Smooth	
Description: 1100BTCU 18" x 84" Cover		Detail Rev.
Part Number / Numéro Pièce: 1100BTCU07203C	Rev.:	8
		0
		8

Qty	Part Name	Rev	Description
1	STK-P-02400S	0	Powder Paint (Asa-61 Grey / Smooth)
1	1100BTCU07203F-P	0	1100BTCU 18" x 84" Flanged Cover Part
1	1100BTCU07203C-P	0	1100BTCU 18" x 84" Flat Cover Part
1	STK-S-00100	0	3.5" x 2" Silver Milar Flexcon Sticker
Parts List			