

This drawing is confidential and must not be reproduced or used without the consent of EXM

All knockouts are actual size / Les disques défonçables sont grandeur réel  
 All dimensions are before paint / Toutes les dimensions sont avant peinture

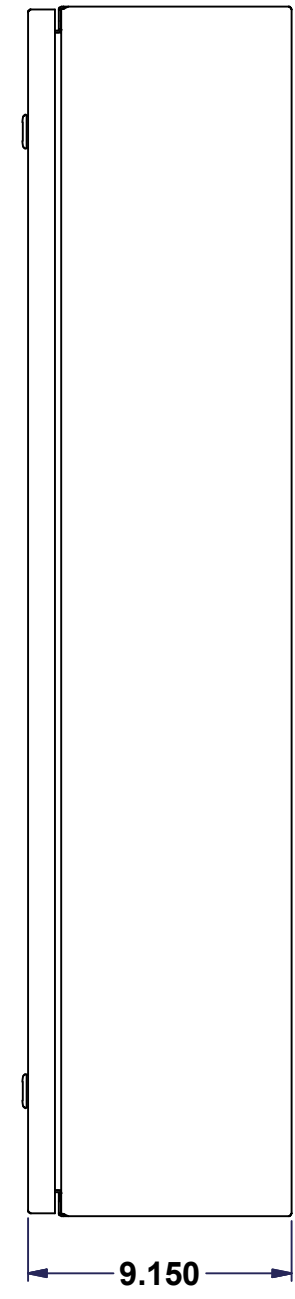

No.	Revisions	Date	By/Par
1	Turn into iLogic	06-May-10	AllenL
1.1	Revise cover type per 881CE	12/13/2010	AllenL

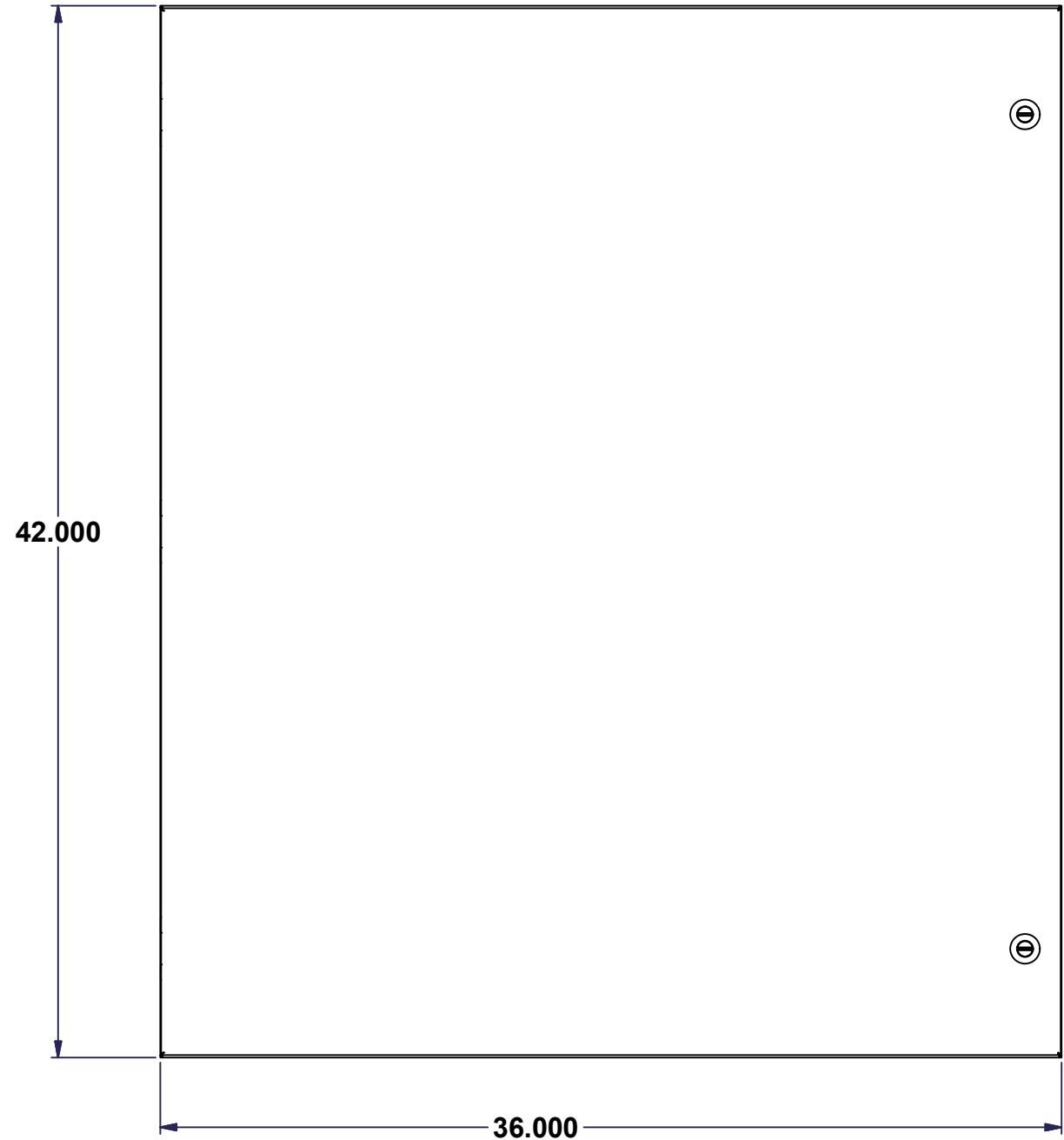
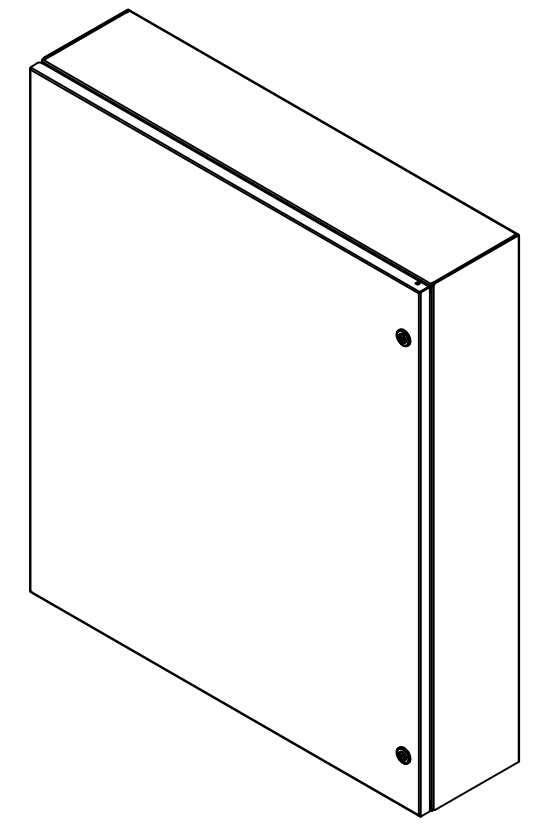

Ce dessin est confidentiel et ne doit pas être reproduit ou utilisé sans le consentement de EXM

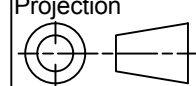
 Tél: (450) 979-4373 Fax: (450) 979-4626 <a href="http://www.exmweb.com">www.exmweb.com</a>		Flatness Aplatissement Max 3.0mm Projection 
Customer Client	Date	
Drawn By Dessiné Par MichaelA	Date 22-Jan-15	
Material Matière	See Part List	
Color Couleur	See Part List	Finish Fini See Part List
Description 1100 CIP 42" x 36" 8" Assembly		Detail Rev.
Part Number Numéro Pièce <b>1100CIP423608</b>	Rev. <b>1</b>	1 1