

This drawing is confidential and must not be reproduced or used without the consent of EXM

Ce dessin est confidentiel et ne doit pas être reproduit ou utilisé sans le consentement de EXM

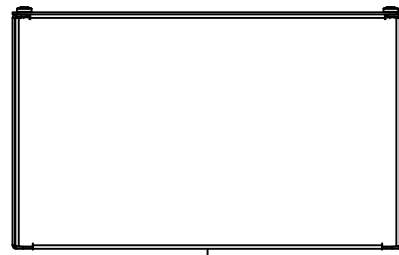

TOP

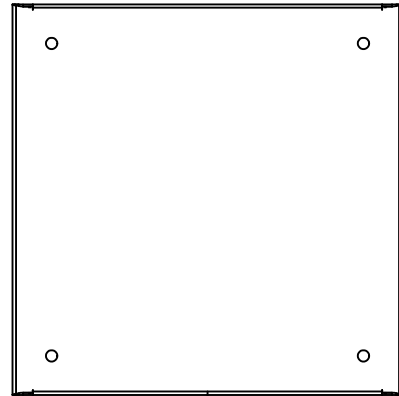

BACK

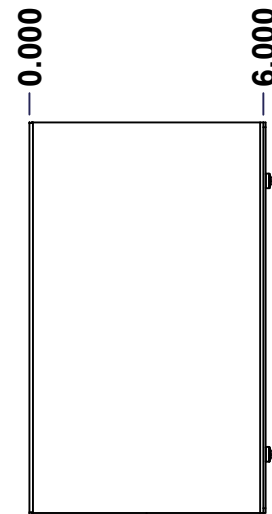

LEFT

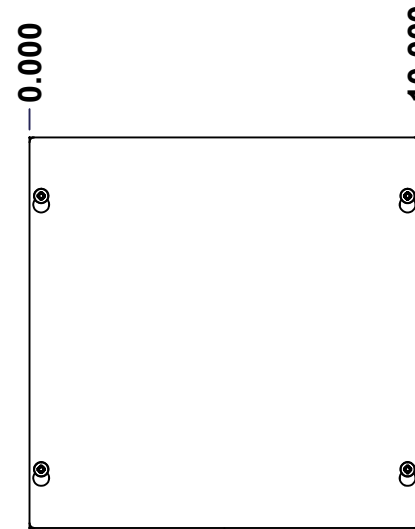

FRONT

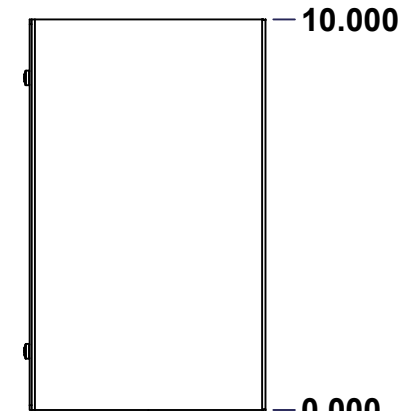

RIGHT

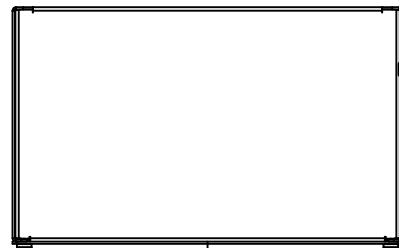

BOTTOM

No.	Revisions	Date	By/Par

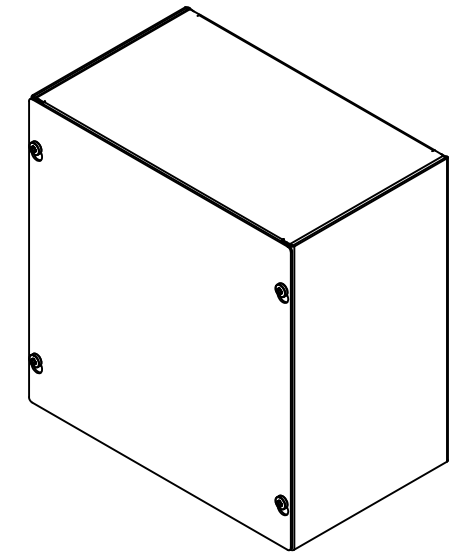

Isometric View



Tél: (450) 979-4373
 Fax: (450) 979-4626
www.exmweb.com

Flatness
Aplatissement
Max 3.0mm
Projection

Customer Client	Date
Drawn By / Dessiné Par: BoxCad: BoxCad	Date: 17-Oct-13
Material / Matière: 16 Ga H.R.P. & O. (1.4mm)	
Color / Couleur: Asa-61 Grey	Finish / Fini: Smooth
Description: 1100DFN 10" x 10" x 6" Assembly	Detail Rev.
Part Number / Numéro Pièce: 1100DF101006N	Rev. 0

SEE BILL OF MATERIAL ON LAST PAGE

1
2

This drawing is confidential and must not be reproduced or used without the consent of EXM

Ce dessin est confidentiel et ne doit pas être reproduit ou utilisé sans le consentement de EXM

NOTE	
ITEM	DESCRIPTION
1	NEMA 1 Enclosure
2	C/W Standard ground provision on box and cover
3	W/O Standard door stiffener
4	W/O Inner panel
5	W/O Inner panel mounting provision

No.	Revisions	Date	By/Par

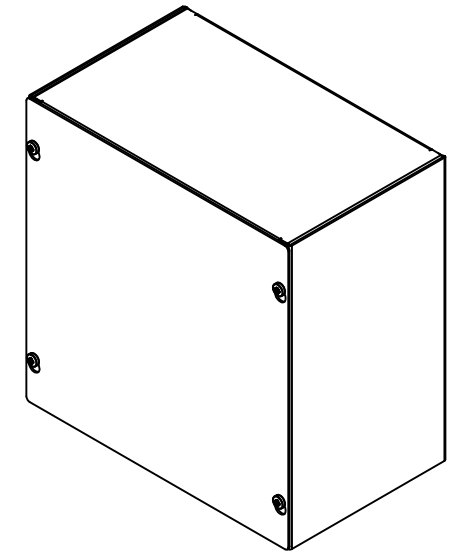

Isometric View

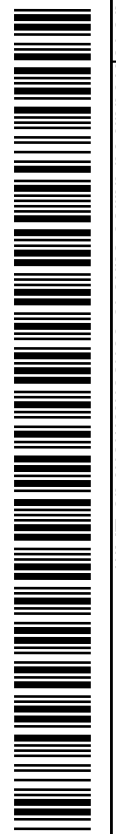

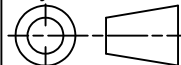
 Tél: (450) 979-4373 Fax: (450) 979-4626 www.exmweb.com		Flatness Aplatissement Max 3.0mm Projection 
Customer Client	Date	
Drawn By Dessiné Par	BoxCad: BoxCad	Date 17-Oct-13
Material Matière	16 Ga H.R.P. & O. (1.4mm)	
Color Couleur	Asa-61 Grey	Finish Fini Smooth
Description	Detail Rev.	
1100DFN 10" x 10" x 6" Assembly		
Part Number Numéro Pièce	Rev.	2
1100DF101006N	0	2

PACKING		
ITEM	QTY	DESCRIPTION
Thermal plastic film	1	Use with Packing Tunnel Wrapper Machine
Packaging label	1	White label with product number

Qty	Part Number	Rev	Description
4	STK-Q-05020	5	M5 x 8mm Thread Rolling Screw
1	1100DF101006NC	0	1100DFN 10" x 10" Cover
1	1100DF101006NB	0	1100DFN 10" x 10" x 6" Body
Parts List			

This drawing is confidential and must not be reproduced or used without the consent of EXM

Ce dessin est confidentiel et ne doit pas être reproduit ou utilisé sans le consentement de EXM

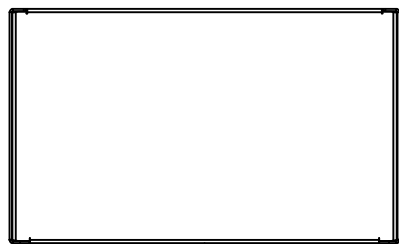

TOP

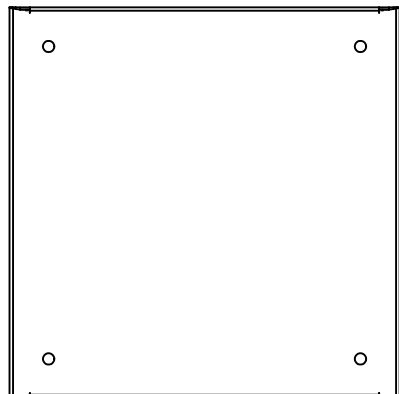

BACK

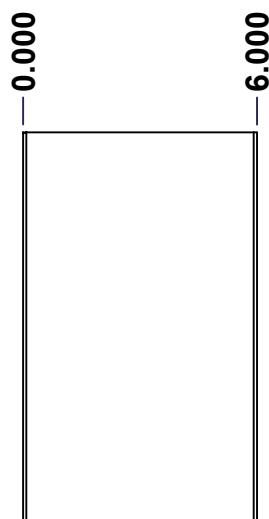

LEFT

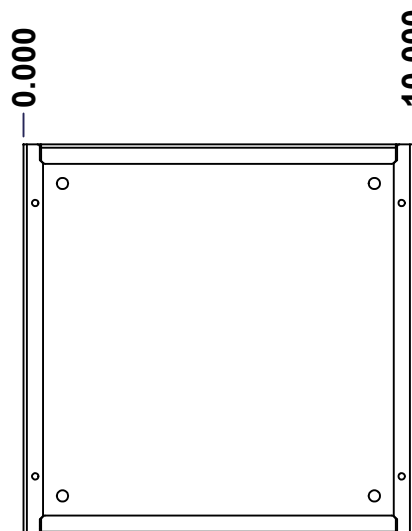

FRONT

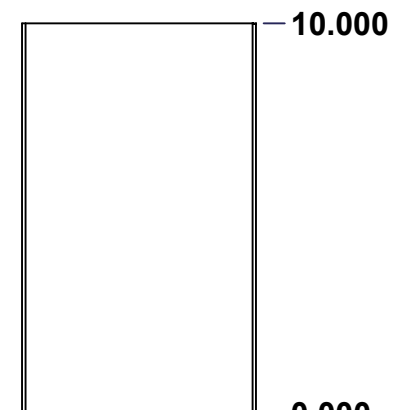

RIGHT

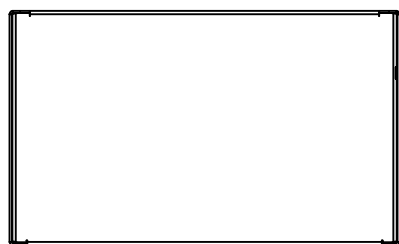

BOTTOM

No.	Revisions	Date	By/Par

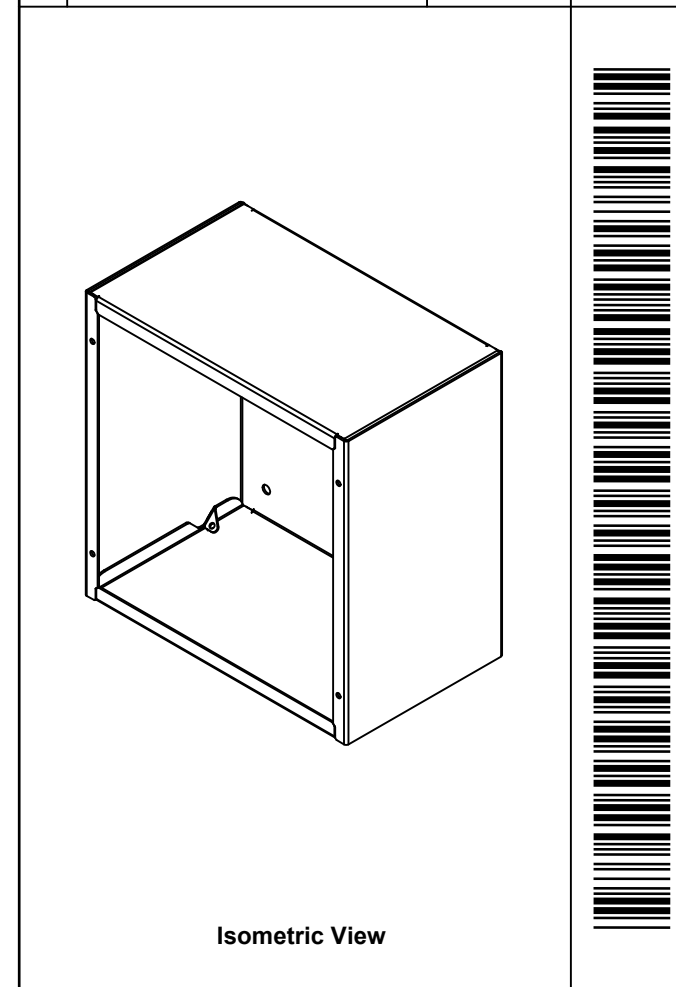

Isometric View

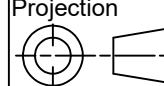

 Tél: (450) 979-4373 Fax: (450) 979-4626 www.exmweb.com		Flatness Aplatissement Max 3.0mm Projection 
Customer Client	Date	
Drawn By / Dessiné Par: BoxCad: BoxCad	Date: 17-Oct-13	
Material / Matière: 16 Ga H.R.P. & O. (1.4mm)		
Color / Couleur: Asa-61 Grey	Finish / Fini: Smooth	
Description: 1100DFN 10" x 10" x 6" Body		Detail Rev.
Part Number / Numéro Pièce: 1100DF101006NB	Rev. 0	1 / 7

SEE BILL OF MATERIAL ON LAST PAGE

This drawing is confidential and must not be reproduced or used without the consent of EXM

Ce dessin est confidentiel et ne doit pas être reproduit ou utilisé sans le consentement de EXM

STANDARD FEATURES ARE NOT LISTED IN THIS HOLE TABLE			
HOLE TABLE - BACK VIEW (CUSTOM FEATURE ONLY)			
CUT-OUT	XDIM	YDIM	DESCRIPTION
1	9.000	1.000	RND Ø0.290
2	9.000	9.000	RND Ø0.290
3	1.000	9.000	RND Ø0.290
4	1.000	1.000	RND Ø0.290

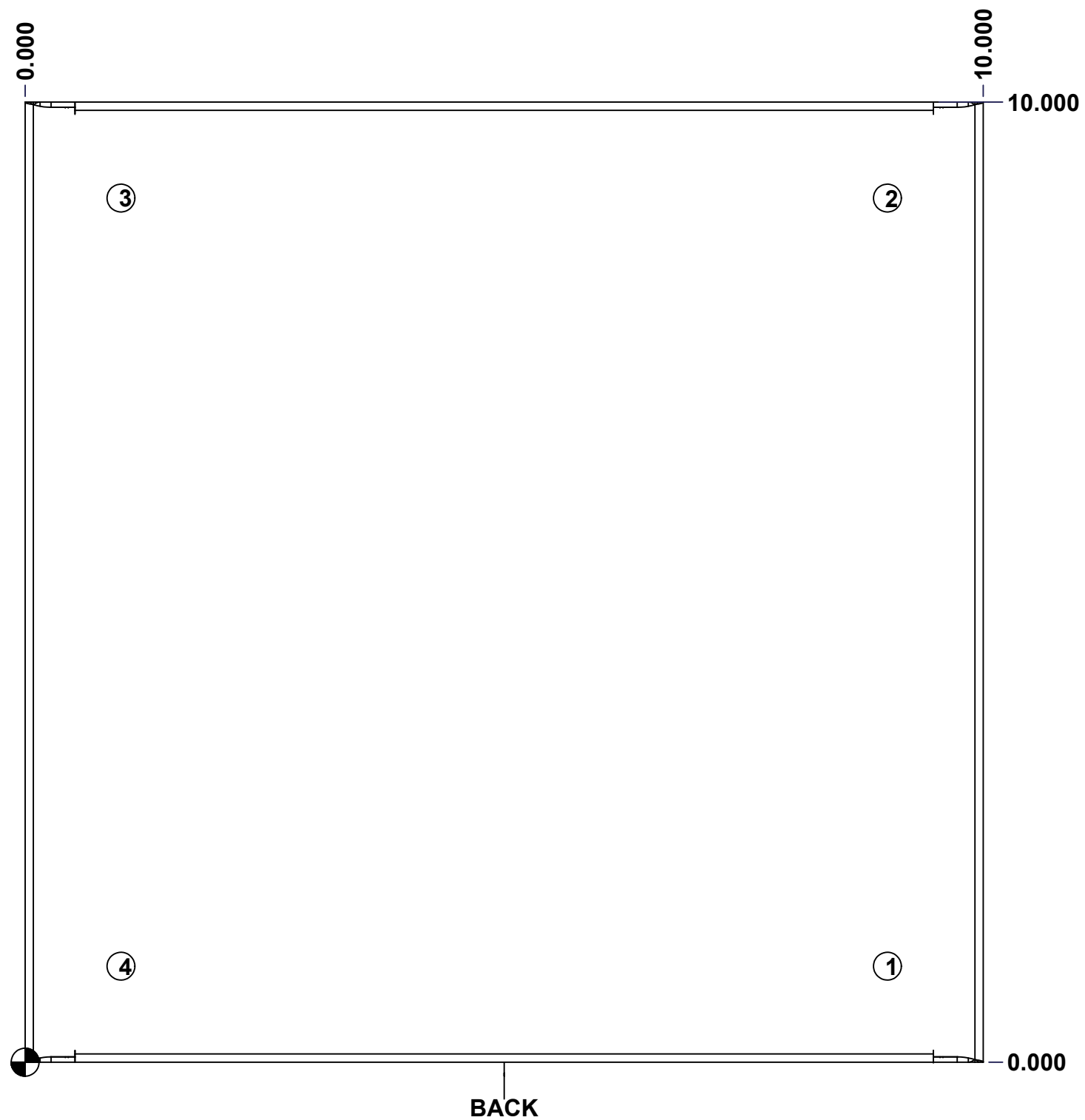

	Description	Status	
	1100DFN 10" x 10" x 6" Body	(NULL)	
	Part Number Numéro Pièce	Rev.	6
	1100DF101006NB	0	7

This drawing is confidential and must not be reproduced or used without the consent of EXM

Ce dessin est confidentiel et ne doit pas être reproduit ou utilisé sans le consentement de EXM

No.	Revisions	Date	By/Par

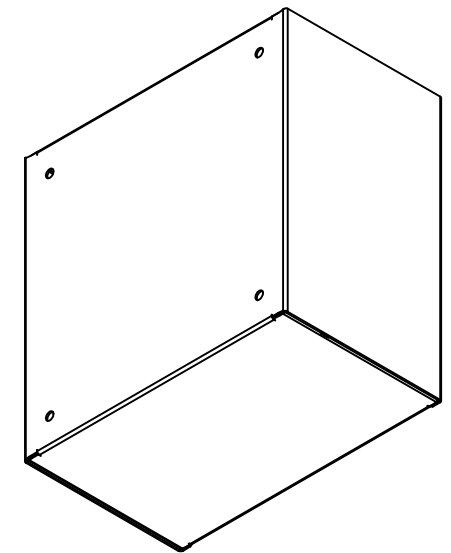

Isometric View



Tél: (450) 979-4373
 Fax: (450) 979-4626
www.exmweb.com

Flatness
Aplatissement

Max 3.0mm

Projection

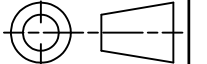

Customer Client	Date
Drawn By / Dessiné Par: BoxCad: BoxCad	Date: 17-Oct-13
Material / Matière: 16 Ga H.R.P. & O. (1.4mm)	
Color / Couleur: Asa-61 Grey	Finish / Fini: Smooth
Description: 1100DFN 10" x 10" x 6" Body	Detail Rev.
Part Number / Numéro Pièce: 1100DF101006NB	Rev. 0

Qty	Part Number	Rev	Description
1	STK-P-02400S	0	Powder Paint (Asa-61 Grey / Smooth)
1	1100DF101006NB-P	0	1100DFN 10" x 10" x 6" Body Part
Parts List			

7
7

This drawing is confidential and must not be reproduced or used without the consent of EXM

Ce dessin est confidentiel et ne doit pas être reproduit ou utilisé sans le consentement de EXM

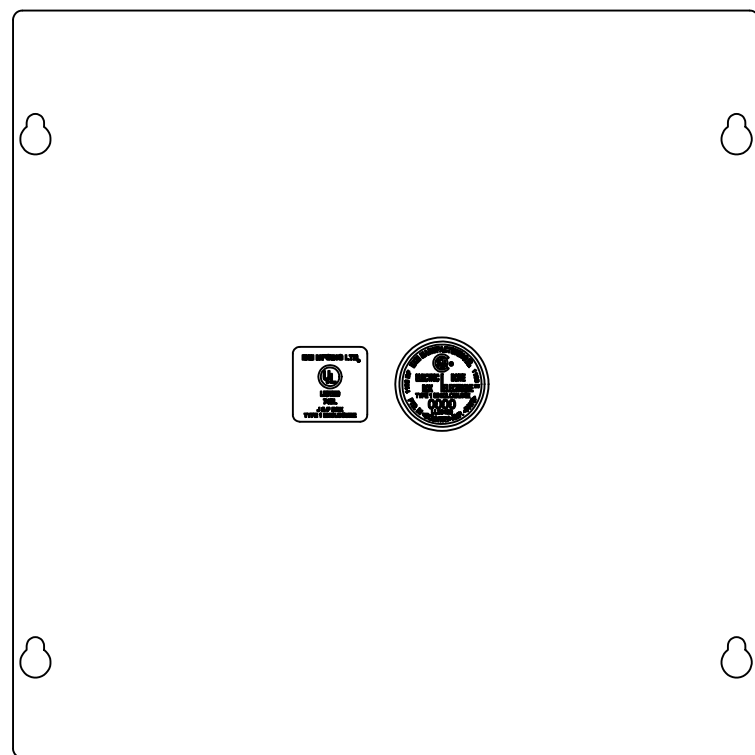
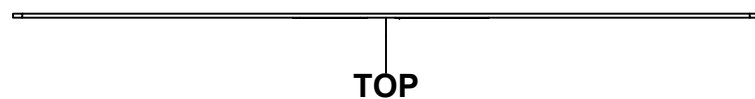

BACK

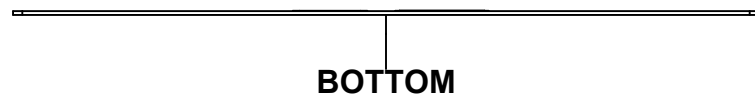

LEFT

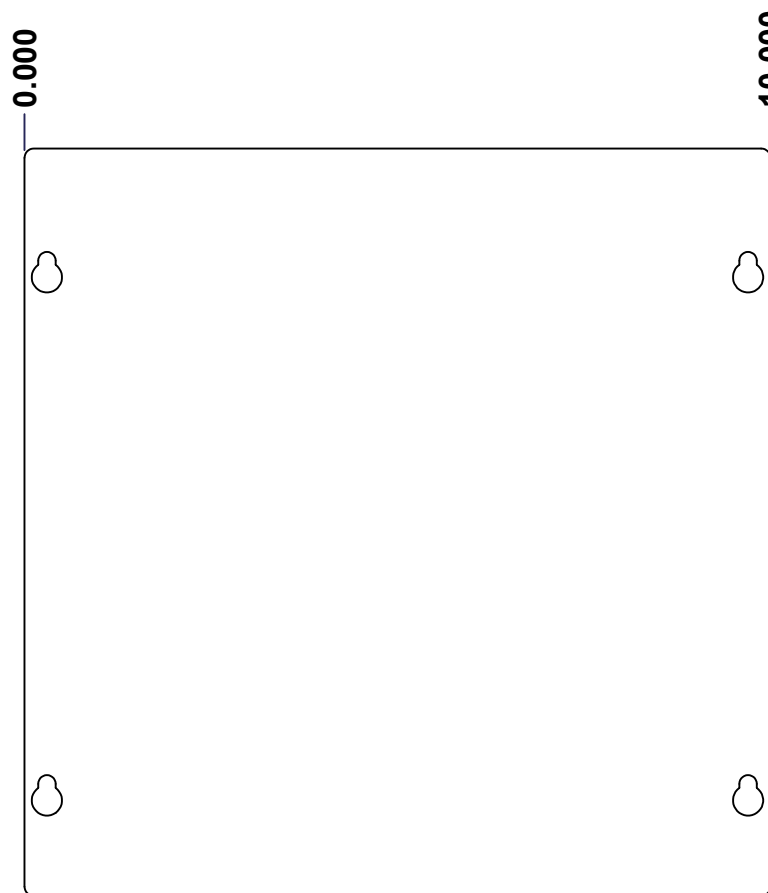

FRONT

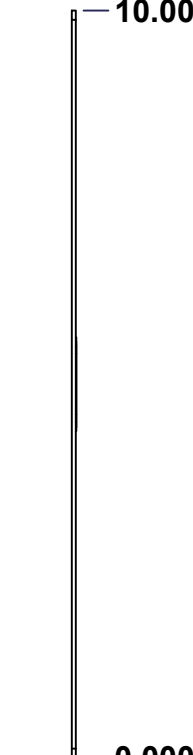

RIGHT

No.	Revisions	Date	By/Par

Isometric View

Tél: (450) 979-4373 Fax: (450) 979-4626 www.exmweb.com		Flatness Aplatissement			
		Max 3.0mm			
Customer Client		Date			
Drawn By Dessiné Par BoxCad: BoxCad		Date 17-Oct-13			
Material Matière 16 Ga H.R.P. & O. (1.4mm)		Projection			
Color Couleur Asa-61 Grey		Finish Fini Smooth			
Description 1100DFN 10" x 10" Cover		Detail Rev.			
Part Number Numéro Pièce 1100DF101006NC		Rev. 0	<table border="1" style="width: 100%;"> <tr> <td style="text-align: center;">1</td> </tr> <tr> <td style="text-align: center;">3</td> </tr> </table>	1	3
1					
3					

SEE BILL OF MATERIAL ON LAST PAGE

This drawing is confidential and must not be reproduced or used without the consent of EXM

Ce dessin est confidentiel et ne doit pas être reproduit ou utilisé sans le consentement de EXM

No.	Revisions	Date	By/Par

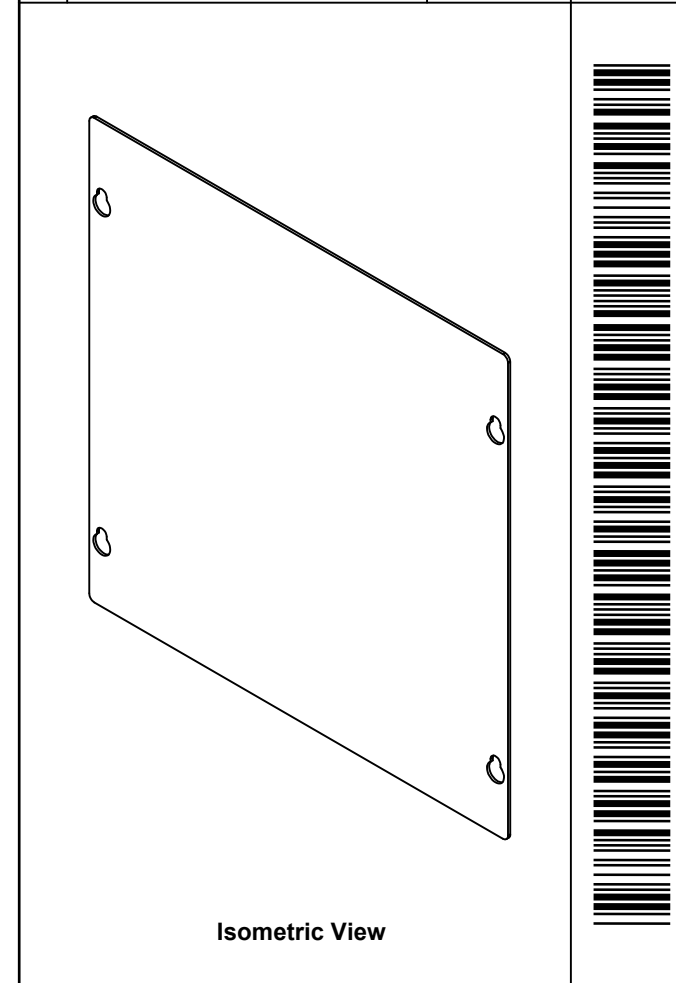

 Tél: (450) 979-4373 Fax: (450) 979-4626 www.exmweb.com		Flatness Aplatissement Max 3.0mm Projection 
Customer Client	Date	
Drawn By Dessiné Par	BoxCad: BoxCad	Date 17-Oct-13
Material Matière	16 Ga H.R.P. & O. (1.4mm)	
Color Couleur	Asa-61 Grey	Finish Fini Smooth
Description		Detail Rev.
1100DFN 10" x 10" Cover		
Part Number Numéro Pièce	Rev.	3
1100DF101006NC	0	3

Qty	Part Number	Rev	Description
1	STK-S-00950	1	UL 74SL Pull-Box Sticker
1	STK-S-00800	2	CSA Electrical Box Sticker
1	1100DF101006NC-P	0	1100DFN 10" x 10" Cover Part
1	STK-P-02400S	0	Powder Paint (Asa-61 Grey / Smooth)
Parts List			