

This drawing is confidential and must not be reproduced or used without the consent of EXM

Ce dessin est confidentiel et ne doit pas être reproduit ou utilisé sans le consentement de EXM

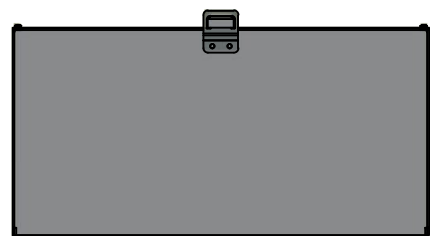

TOP

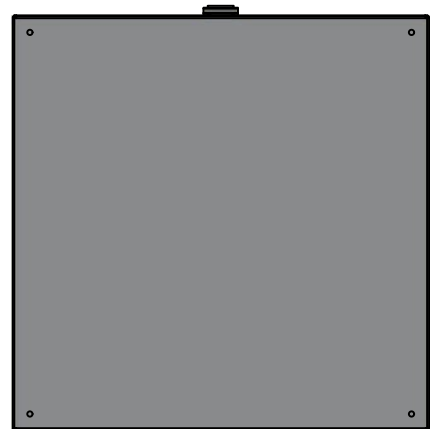

BACK

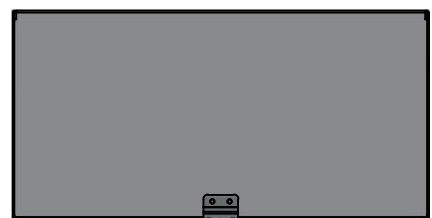

BOTTOM

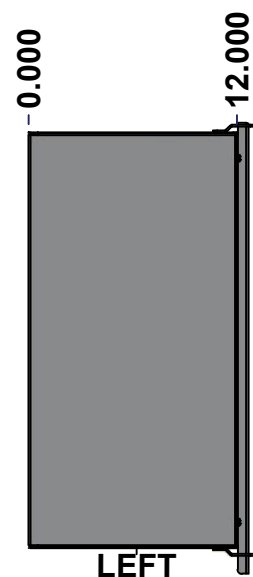

LEFT

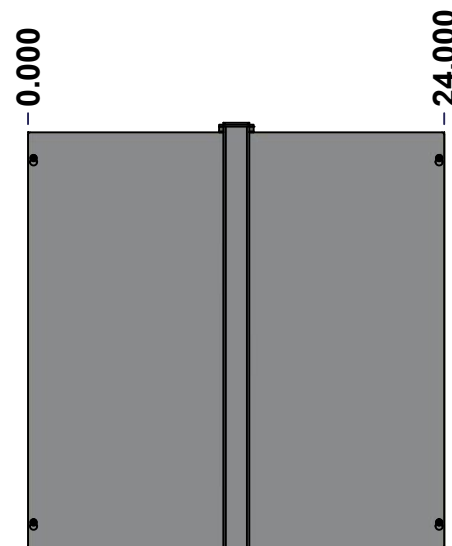

FRONT

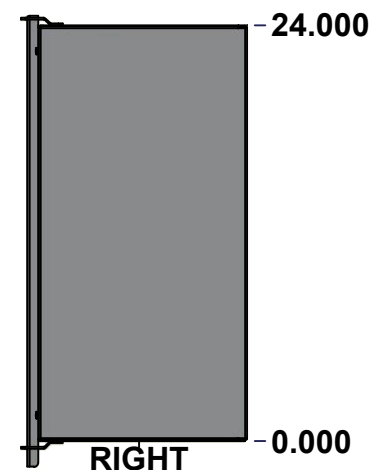

RIGHT

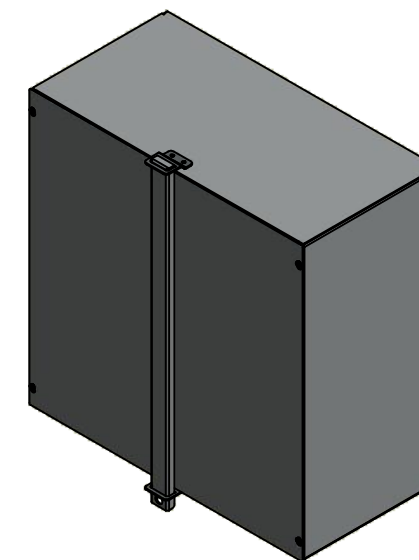

Isometric View

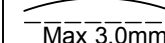
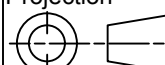

No.	Revisions	Date	By/Par

 Tél: (450) 979-4373 Fax: (450) 979-4626 www.exmweb.com		Flatness Aplatissement  Max 3.0mm Projection 
Customer Client	Date	
Drawn By Dessiné Par	BoxCad: BoxCad	Date 20-Jul-22
Material Matière	14 Ga Cold Rolled A1008 CS Type B (1.7mm)	
Color Couleur	Asa-61 Grey	Finish Fini Smooth
Description 1100DFPN 24" x 24" x 12" Assembly		Detail Rev.
Part Number Numéro Pièce	1100DFP242412N	Rev. 1 0

SEE BILL OF MATERIAL ON LAST PAGE

This drawing is confidential and must not be reproduced or used without the consent of EXM

Ce dessin est confidentiel et ne doit pas être reproduit ou utilisé sans le consentement de EXM

NOTE	
ITEM	DESCRIPTION
1	NEMA 1 Enclosure
2	C/W Standard ground provision on box and cover
3	W/O Standard door stiffener
4	W/O Inner panel
5	W/O Inner panel mounting provision
6	C/W Padlock Kit (Not Installed)

No.	Revisions	Date	By/Par

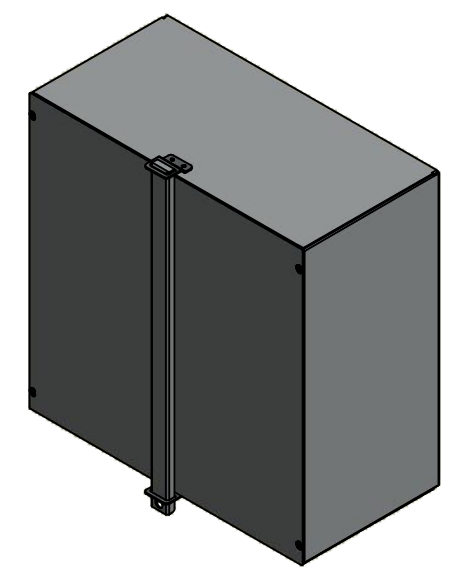

Isometric View



Tél: (450) 979-4373
 Fax: (450) 979-4626
www.exmweb.com

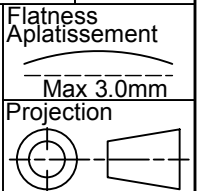

Customer Client	Date
Drawn By / Dessiné Par: BoxCad: BoxCad	Date: 20-Jul-22
Material / Matière: 14 Ga Cold Rolled A1008 CS Type B (1.7mm)	

Color / Couleur: Asa-61 Grey	Finish / Fini: Smooth
Description: 1100DFPN 24" x 24" x 12" Assembly	Detail Rev.
Part Number / Numéro Pièce: 1100DFP242412N	Rev. 2 / 0

PACKING		
ITEM	QTY	DESCRIPTION
Cardboard sleeve	2	Top and Bottom
Plastic strap - Black	2	To squeeze the 2 cardboard sleeve together
Thermal plastic film	1	Use with Packing Tunnel Wrapper Machine
Packaging label	1	White label with product number

Qty	Part Number	Rev	Description
1	880 DPF24	0	880 DFP Padlock Kit
4	STK-Q-05020	5	M5 x 8mm Thread Rolling Screw
1	1100DFP242412NC	0	1100DFPN 24" x 24" Cover
1	1100DFP242412NB	0	1100DFPN 24" x 24" x 12" Body

Parts List

This drawing is confidential and must not be reproduced or used without the consent of EXM

Ce dessin est confidentiel et ne doit pas être reproduit ou utilisé sans le consentement de EXM

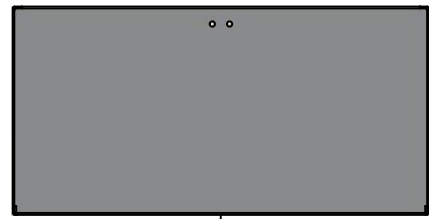

TOP

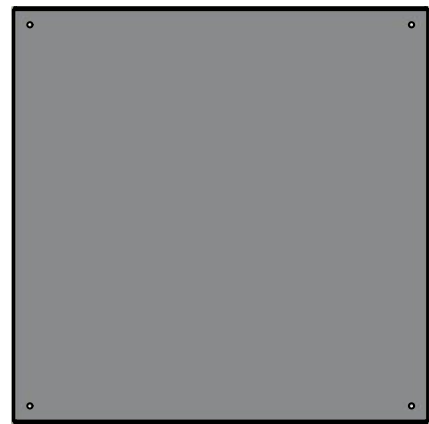

BACK

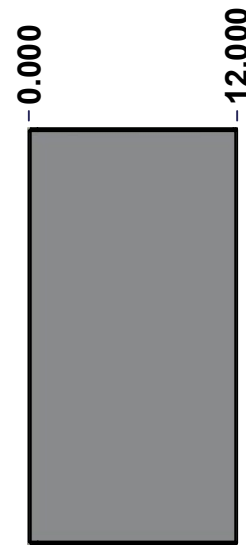

LEFT

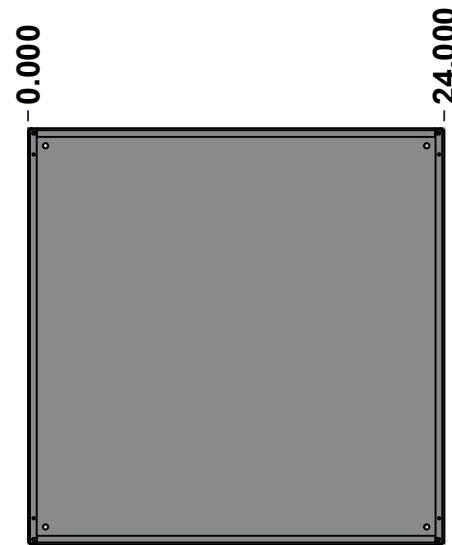

FRONT

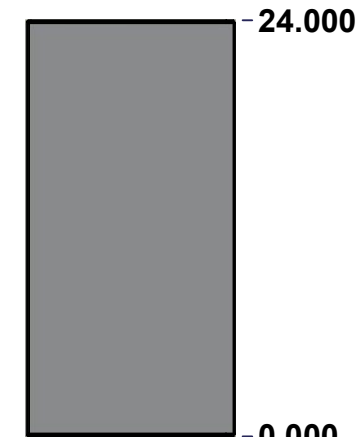

RIGHT



BOTTOM

No.	Revisions	Date	By/Par

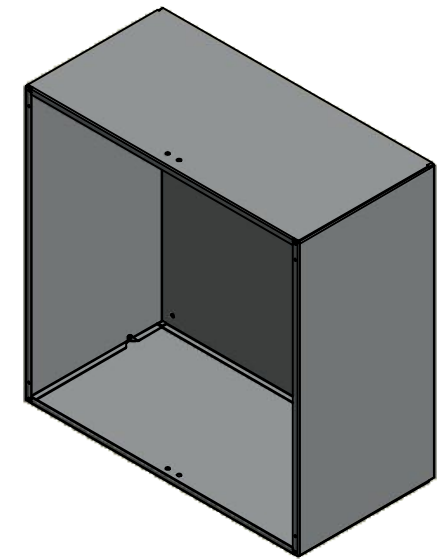

Isometric View



Tél: (450) 979-4373
 Fax: (450) 979-4626
www.exmweb.com

Flatness
Aplatissement

Max 3.0mm

Projection



Customer Client	Date
Drawn By Dessiné Par BoxCad: BoxCad	Date 20-Jul-22
Material Matière 14 Ga Cold Rolled A1008 CS Type B (1.7mm)	
Color Couleur Asa-61 Grey	Finish Fini Smooth
Description 1100DFPN 24" x 24" x 12" Body	Detail Rev.
Part Number Numéro Pièce 1100DFP242412NB	Rev. 3 0 10

SEE BILL OF MATERIAL ON LAST PAGE

This drawing is confidential and must not be reproduced or used without the consent of EXM

Ce dessin est confidentiel et ne doit pas être reproduit ou utilisé sans le consentement de EXM

STANDARD FEATURES ARE NOT LISTED IN THIS HOLE TABLE			
HOLE TABLE - TOP VIEW (CUSTOM FEATURE ONLY)			
CUT-OUT	XDIM	YDIM	DESCRIPTION
1	11.500	11.000	RND Ø0.290
2	12.500	11.000	RND Ø0.290



	Description	Status	
	1100DFPN 24" x 24" x 12" Body	(NULL)	
	Part Number Numéro Pièce	Rev.	
	1100DFP242412NB	0	4 / 10

This drawing is confidential and must not be reproduced or used without the consent of EXM

Ce dessin est confidentiel et ne doit pas être reproduit ou utilisé sans le consentement de EXM

STANDARD FEATURES ARE NOT LISTED IN THIS HOLE TABLE			
HOLE TABLE - BOTTOM VIEW (CUSTOM FEATURE ONLY)			
CUT-OUT	XDIM	YDIM	DESCRIPTION
1	11.500	11.000	RND Ø0.290
2	12.500	11.000	RND Ø0.290

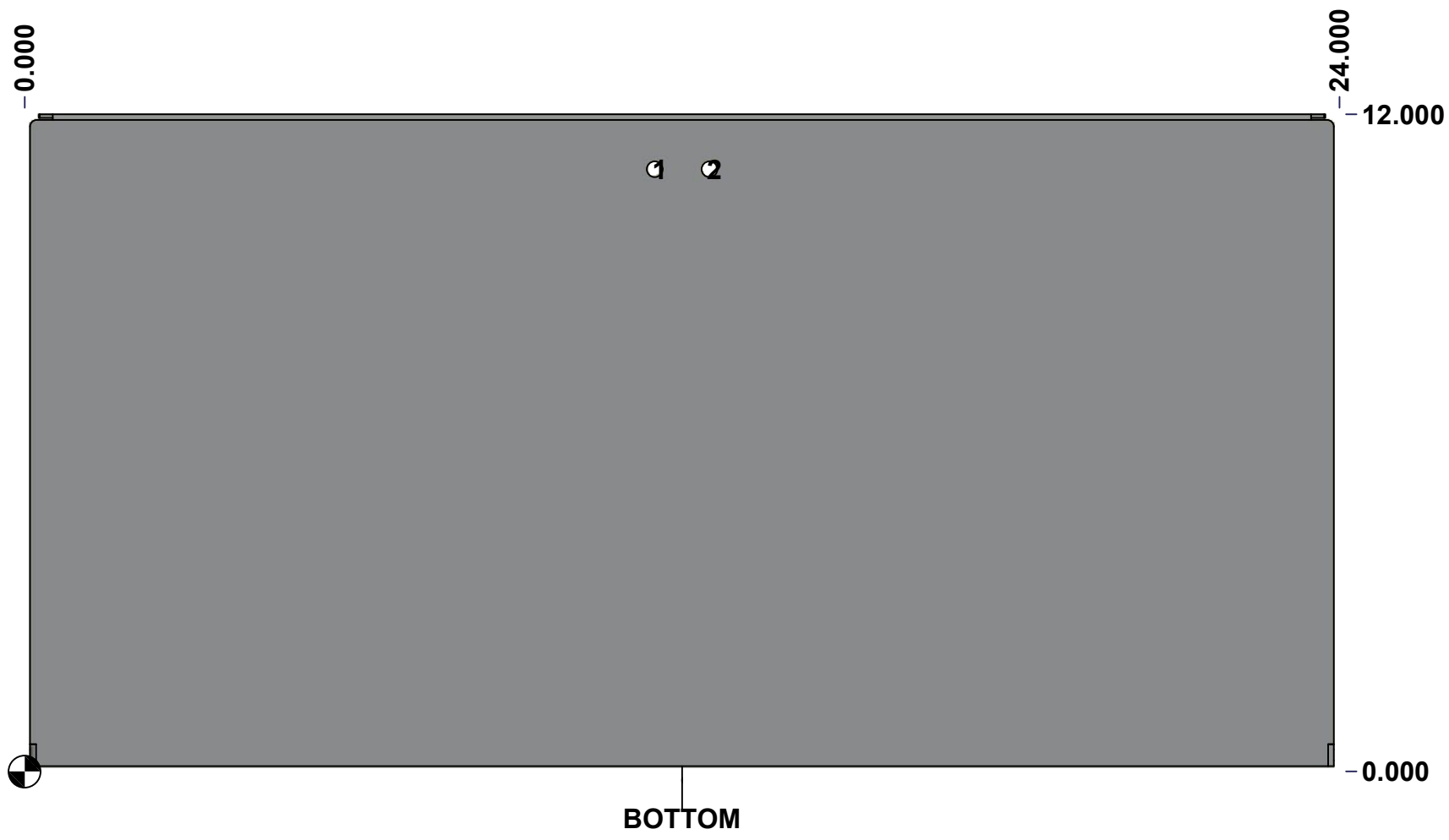

	Description		Status
	1100DFPN 24" x 24" x 12" Body		(NULL)
Part Number Numéro Pièce		Rev.	5
1100DFP242412NBB		0	10

This drawing is confidential and must not be reproduced or used without the consent of EXM

Ce dessin est confidentiel et ne doit pas être reproduit ou utilisé sans le consentement de EXM

STANDARD FEATURES ARE NOT LISTED IN THIS HOLE TABLE			
HOLE TABLE - BACK VIEW (CUSTOM FEATURE ONLY)			
CUT-OUT	XDIM	YDIM	DESCRIPTION
1	23.000	1.000	RND Ø0.290
2	23.000	23.000	RND Ø0.290
3	1.000	23.000	RND Ø0.290
4	1.000	1.000	RND Ø0.290

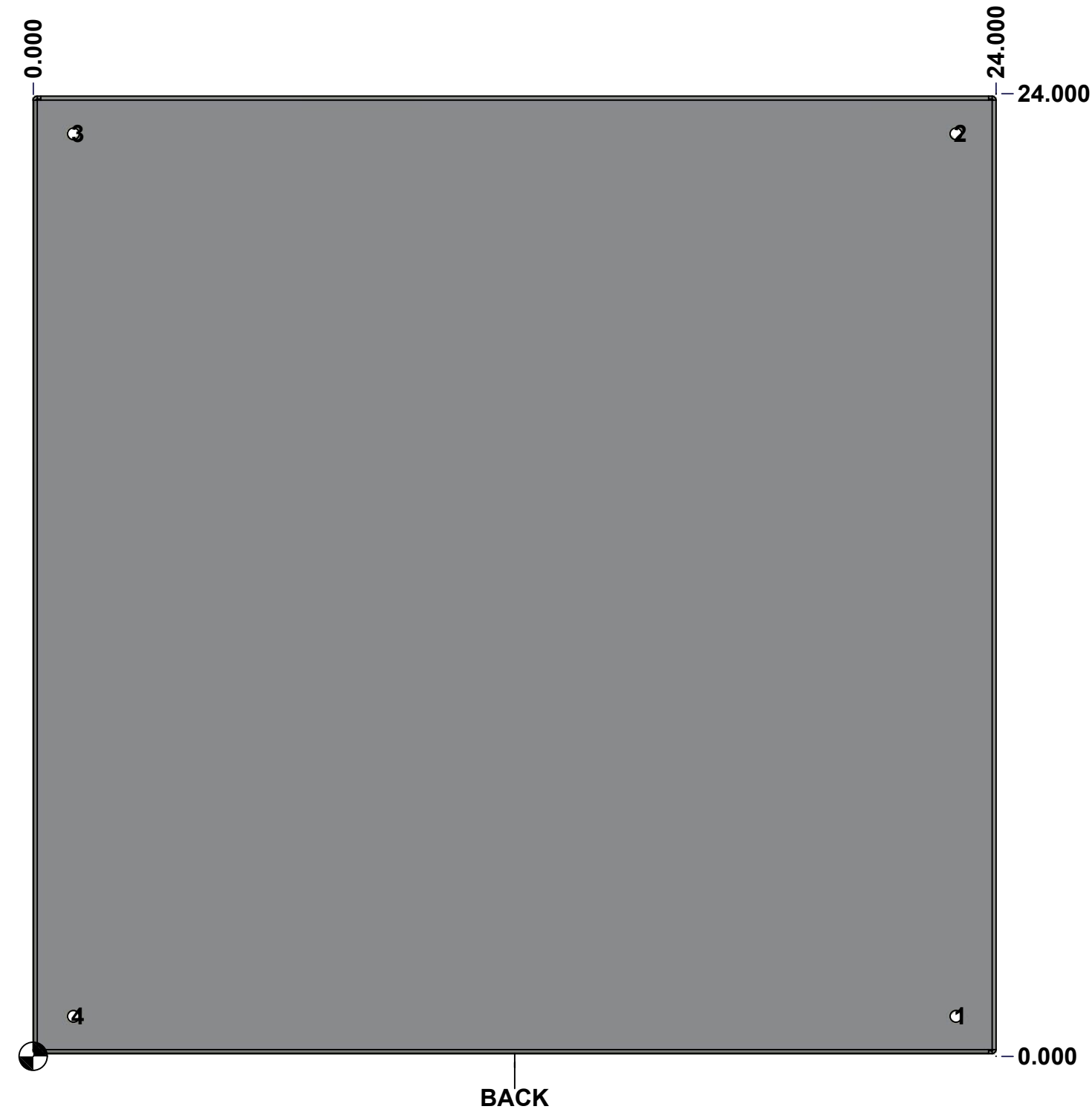

	Description	Status	
	1100DFPN 24" x 24" x 12" Body	(NULL)	
	Part Number Numéro Pièce	Rev.	
	1100DFP242412NB	0	6 / 10

This drawing is confidential and must not be reproduced or used without the consent of EXM

Ce dessin est confidentiel et ne doit pas être reproduit ou utilisé sans le consentement de EXM

No.	Revisions	Date	By/Par

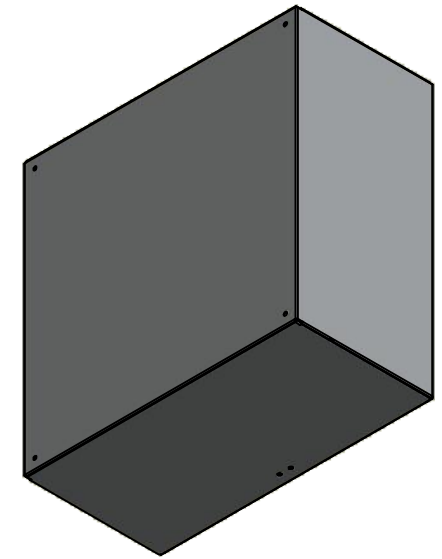

Isometric View



 Tél: (450) 979-4373 Fax: (450) 979-4626 www.exmweb.com		Flatness Aplatissement Max 3.0mm
Customer Client		Date
Drawn By / Dessiné Par: BoxCad: BoxCad		Date: 20-Jul-22
Material / Matière: 14 Ga Cold Rolled A1008 CS Type B (1.7mm)		
Color / Couleur: Asa-61 Grey	Finish / Fini: Smooth	
Description: 1100DFPN 24" x 24" x 12" Body		Detail Rev.
Part Number / Numéro Pièce: 1100DFP242412NB		Rev. 7 / 10

Qty	Part Number	Rev	Description
1	STK-P-02400S	0	Powder Paint (Asa-61 Grey / Smooth)
1	1100DFP242412NT-P	0	1100DFPN 24" x 24" x 12" Body Part
1	1100DFP242412NBT-P	0	1100DFPN 24" x 24" x 12" Body Part
1	1100DFP242412NB-P	0	1100DFPN 24" x 24" x 12" Body Part
Parts List			

This drawing is confidential and must not be reproduced or used without the consent of EXM

Ce dessin est confidentiel et ne doit pas être reproduit ou utilisé sans le consentement de EXM

TOP

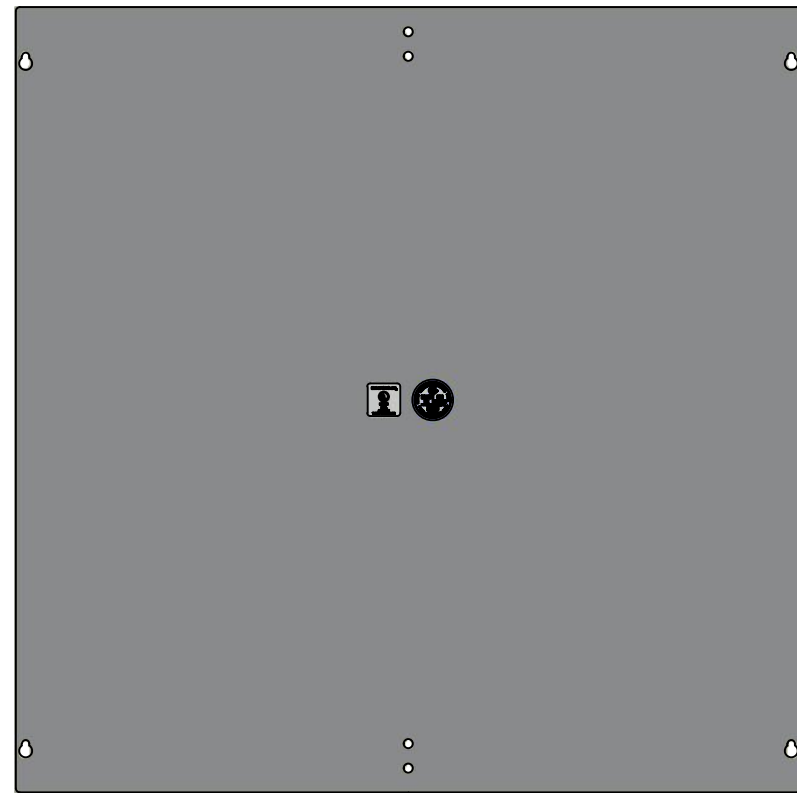

BACK

LEFT

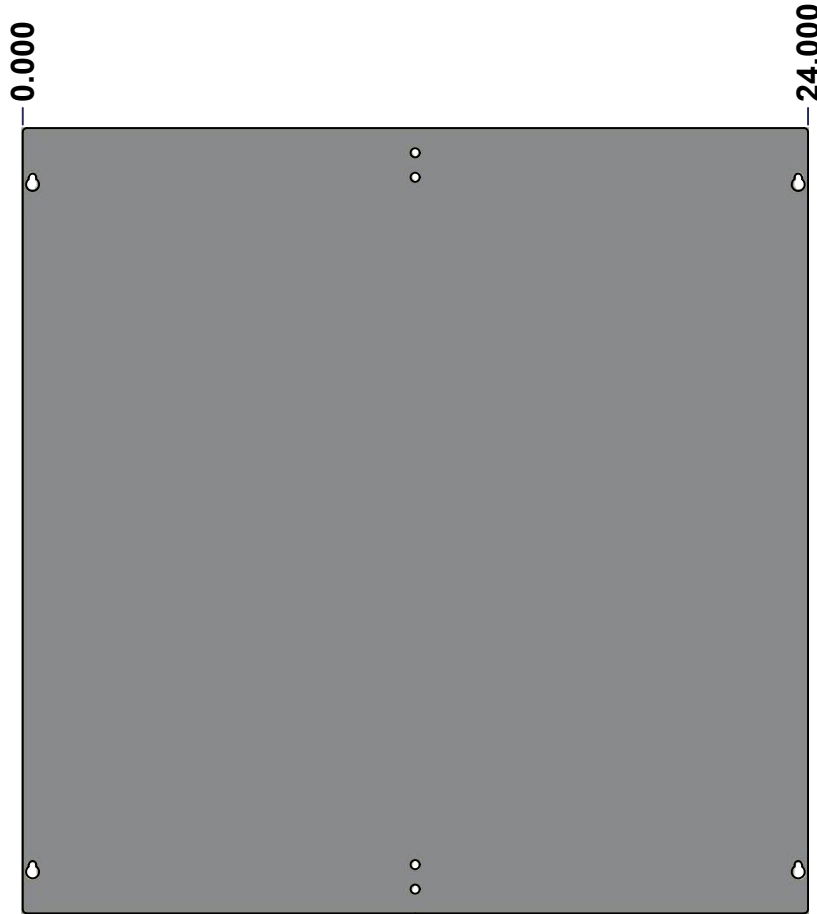

FRONT

RIGHT

No.	Revisions	Date	By/Par

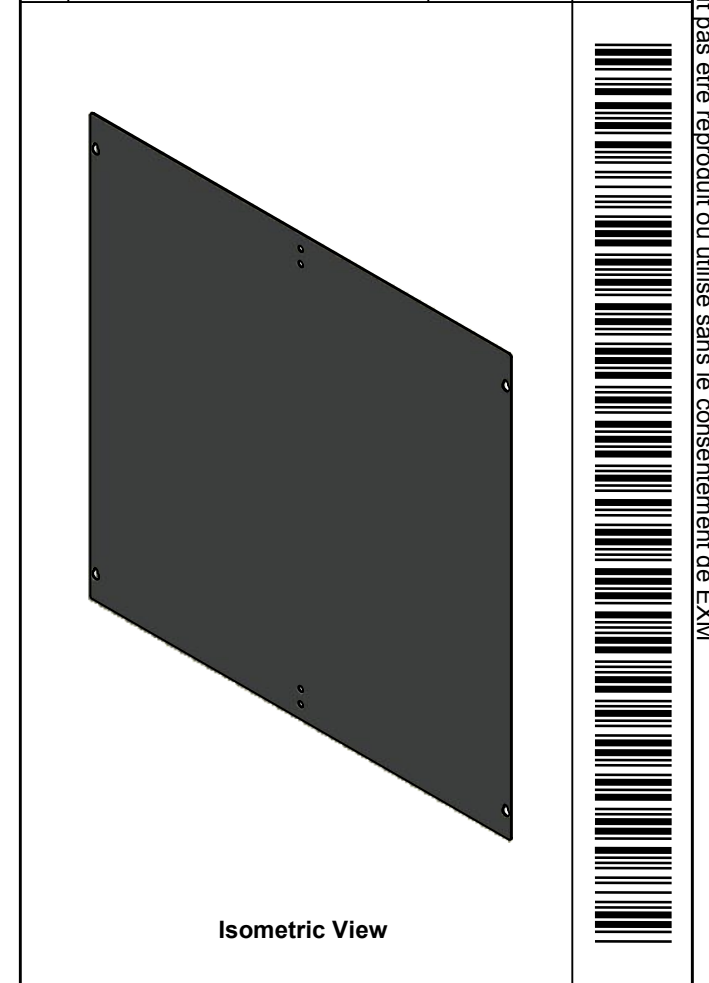

Isometric View

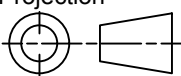
 Tél: (450) 979-4373 Fax: (450) 979-4626 www.exmweb.com		Flatness Aplatissement Max 3.0mm Projection 
Customer Client	Date	
Drawn By / Dessiné Par: BoxCad: BoxCad	Date: 20-Jul-22	
Material / Matière: 16 Ga Cold Rolled A1008 CS Type B (1.4mm)		
Color / Couleur: Asa-61 Grey	Finish / Fini: Smooth	
Description: 1100DFPN 24" x 24" Cover		Detail Rev.
Part Number / Numéro Pièce: 1100DFP242412NC	Rev.: 0	8 / 10

SEE BILL OF MATERIAL ON LAST PAGE

This drawing is confidential and must not be reproduced or used without the consent of EXM

Ce dessin est confidentiel et ne doit pas être reproduit ou utilisé sans le consentement de EXM

STANDARD FEATURES ARE NOT LISTED IN THIS HOLE TABLE			
HOLE TABLE - FRONT VIEW (CUSTOM FEATURE ONLY)			
CUT-OUT	XDIM	YDIM	DESCRIPTION
1	12.000	23.250	RND Ø0.290
2	12.000	22.500	RND Ø0.290
3	12.000	1.500	RND Ø0.290
4	12.000	0.750	RND Ø0.290

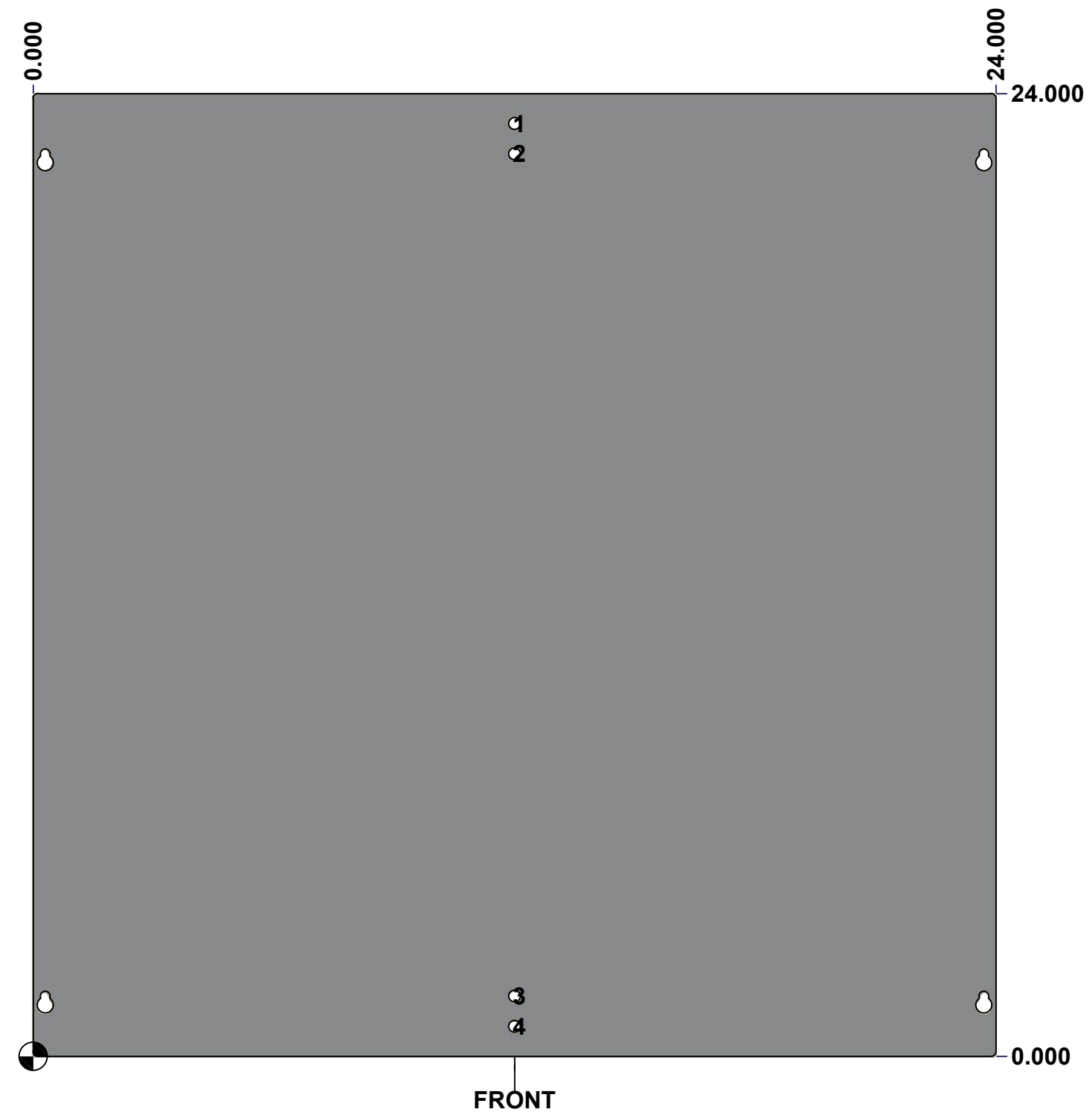



	Description	Status	
	1100DFPN 24" x 24" Cover	(NULL)	
	Part Number Numéro Pièce	Rev.	
	1100DFP242412NC	0	9 10

This drawing is confidential and must not be reproduced or used without the consent of EXM

Ce dessin est confidentiel et ne doit pas être reproduit ou utilisé sans le consentement de EXM

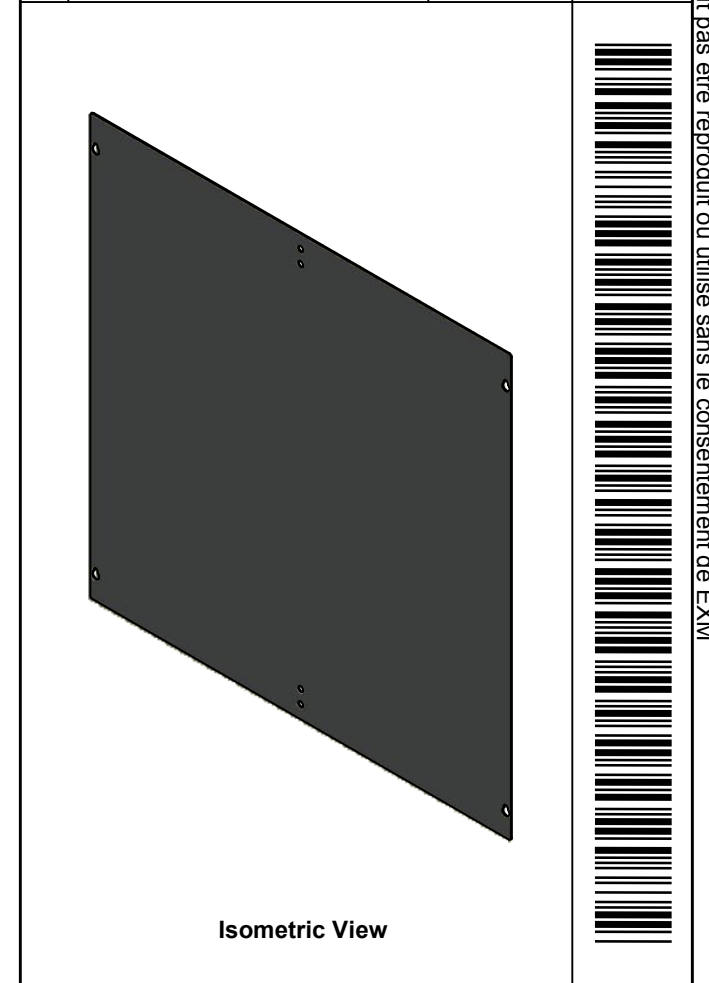
No.	Revisions	Date	By/Par

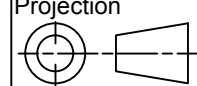

 Tél: (450) 979-4373 Fax: (450) 979-4626 www.exmweb.com		Flatness Aplatissement Max 3.0mm Projection 
Customer Client	Date	
Drawn By Dessiné Par	BoxCad: BoxCad	Date 20-Jul-22
Material Matière	16 Ga Cold Rolled A1008 CS Type B (1.4mm)	
Color Couleur	Asa-61 Grey	Finish Fini Smooth
Description		Detail Rev.
1100DFPN 24" x 24" Cover		
Part Number Numéro Pièce	Rev.	10
1100DFP242412NC	0	10

Qty	Part Number	Rev	Description
1	STK-S-00950	1	UL 74SL Pull-Box Sticker
1	STK-S-00800	2	CSA Electrical Box Sticker
1	1100DFP242412NC-P	0	1100DFPN 24" x 24" Cover Part
1	STK-P-02400S	0	Powder Paint (Asa-61 Grey / Smooth)
Parts List			