

This drawing is confidential and must not be reproduced or used without the consent of EXM

Ce dessin est confidentiel et ne doit pas être reproduit ou utilisé sans le consentement de EXM

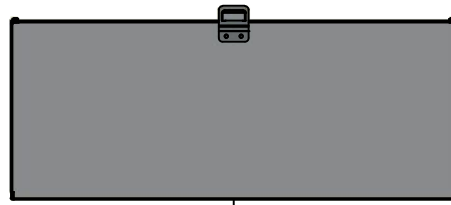

TOP

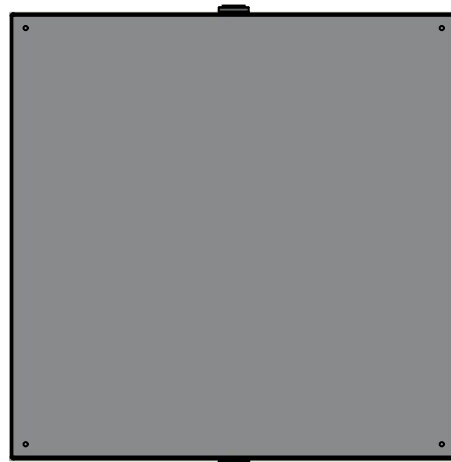

BACK

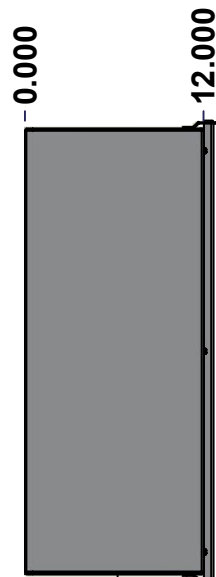

LEFT

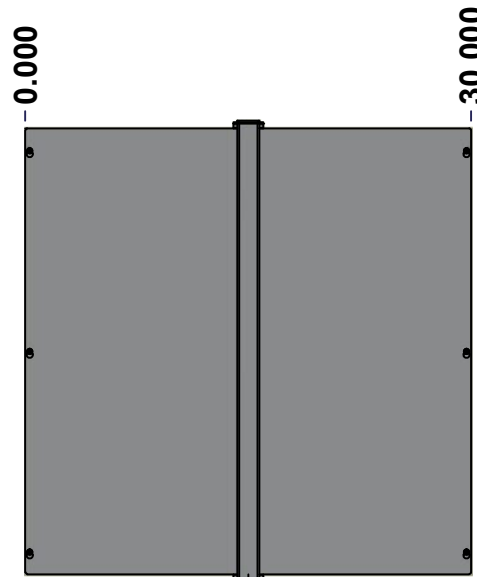

FRONT

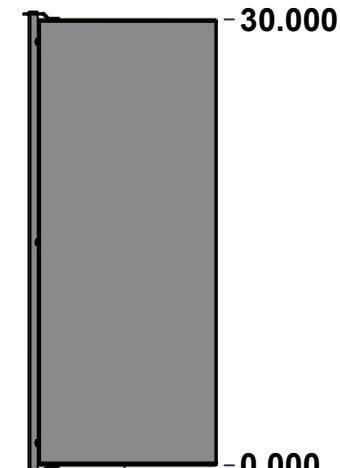

RIGHT



BOTTOM

No.	Revisions	Date	By/Par

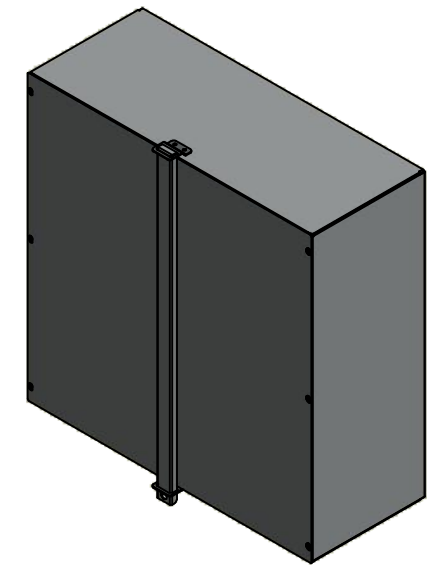

Isometric View



Tél: (450) 979-4373  
 Fax: (450) 979-4626  
[www.exmweb.com](http://www.exmweb.com)

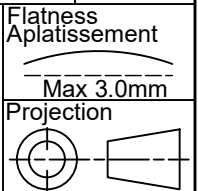

Customer Client	Date
Drawn By / Dessiné Par: BoxCad: BoxCad	Date: 7/20/2022
Material / Matière: 14 Ga Cold Rolled A1008 CS Type B (1.7mm)	
Color / Couleur: Asa-61 Grey	Finish / Fini: Smooth
Description: 1100DFPN 30" x 30" x 12" Assembly	Detail Rev.
Part Number / Numéro Pièce: 1100DFP303012N	Rev. 1

SEE BILL OF MATERIAL ON LAST PAGE

This drawing is confidential and must not be reproduced or used without the consent of EXM

Ce dessin est confidentiel et ne doit pas être reproduit ou utilisé sans le consentement de EXM

NOTE	
ITEM	DESCRIPTION
1	NEMA 1 Enclosure
2	C/W Standard ground provision on box and cover
3	W/O Standard door stiffener
4	W/O Inner panel
5	W/O Inner panel mounting provision
6	C/W Padlock Kit (Not Installed)

No.	Revisions	Date	By/Par

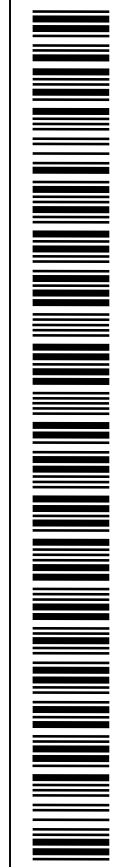
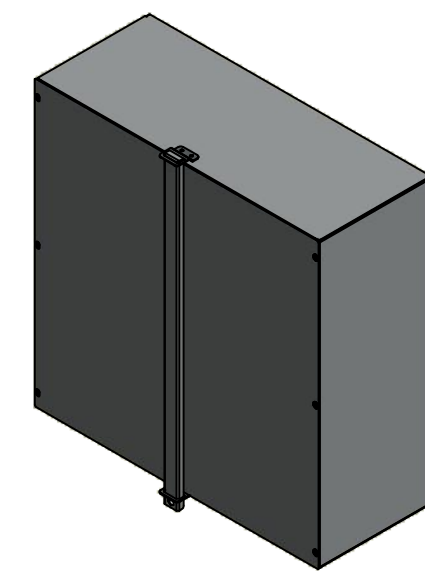

Isometric View



Tél: (450) 979-4373  
 Fax: (450) 979-4626  
[www.exmweb.com](http://www.exmweb.com)

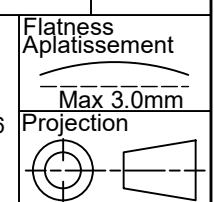

Customer Client	Date
Drawn By / Dessiné Par: BoxCad: BoxCad	Date: 7/20/2022
Material / Matière: 14 Ga Cold Rolled A1008 CS Type B (1.7mm)	

Color / Couleur: Asa-61 Grey	Finish / Fini: Smooth
------------------------------	-----------------------

Description: 1100DFPN 30" x 30" x 12" Assembly	Detail Rev.
--	-------------

Part Number / Numéro Pièce: <b>1100DFP303012N</b>	Rev. 0	2 / 10
---	--------	--------

PACKING		
ITEM	QTY	DESCRIPTION
Cardboard sleeve	2	Top and Bottom
Plastic strap - Black	2	To squeeze the 2 cardboard sleeve together
Thermal plastic film	1	Use with Packing Tunnel Wrapper Machine
Packaging label	1	White label with product number

Qty	Part Number	Rev	Description
1	880 DPF.3	0	880 DFP Padlock Kit
8	STK-Q-05020	5	M5 x 8mm Thread Rolling Screw
1	1100DFP303012NC	0	1100DFPN 30" x 30" Cover
1	1100DFP303012NB	0	1100DFPN 30" x 30" x 12" Body

Parts List

This drawing is confidential and must not be reproduced or used without the consent of EXM

Ce dessin est confidentiel et ne doit pas être reproduit ou utilisé sans le consentement de EXM



TOP

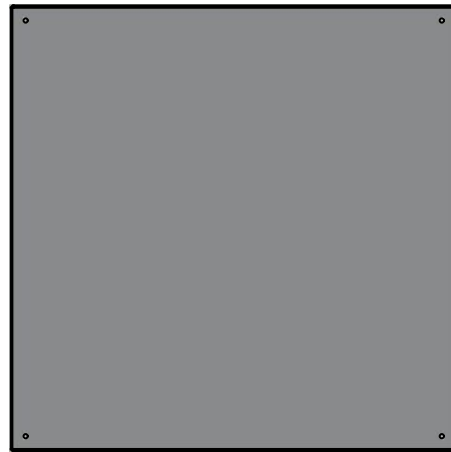

BACK

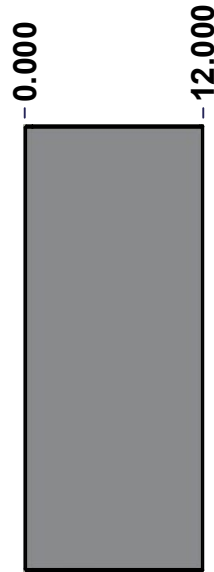

LEFT

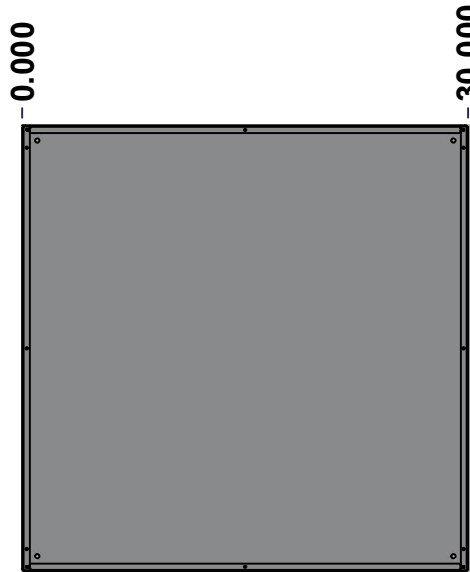

FRONT

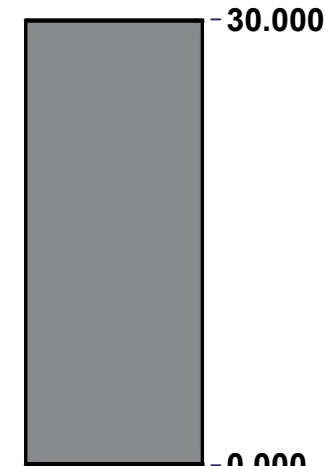

RIGHT



BOTTOM

No.	Revisions	Date	By/Par

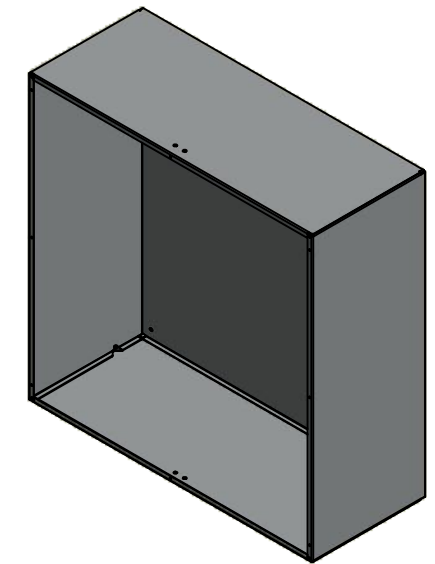

Isometric View



Tél: (450) 979-4373  
 Fax: (450) 979-4626  
[www.exmweb.com](http://www.exmweb.com)

Flatness  
Aplatissement

Max 3.0mm

Projection

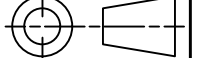

Customer Client	Date
Drawn By / Dessiné Par: BoxCad: BoxCad	Date: 7/20/2022
Material / Matière: 14 Ga Cold Rolled A1008 CS Type B (1.7mm)	
Color / Couleur: Asa-61 Grey	Finish / Fini: Smooth
Description: 1100DFPN 30" x 30" x 12" Body	Detail Rev.
Part Number / Numéro Pièce: 1100DFP303012NB	Rev. 0

SEE BILL OF MATERIAL ON LAST PAGE

This drawing is confidential and must not be reproduced or used without the consent of EXM

Ce dessin est confidentiel et ne doit pas être reproduit ou utilisé sans le consentement de EXM

<b>STANDARD FEATURES ARE NOT LISTED IN THIS HOLE TABLE</b>			
<b>HOLE TABLE - TOP VIEW (CUSTOM FEATURE ONLY)</b>			
CUT-OUT	XDIM	YDIM	DESCRIPTION
1	14.500	11.000	RND Ø0.290
2	15.500	11.000	RND Ø0.290

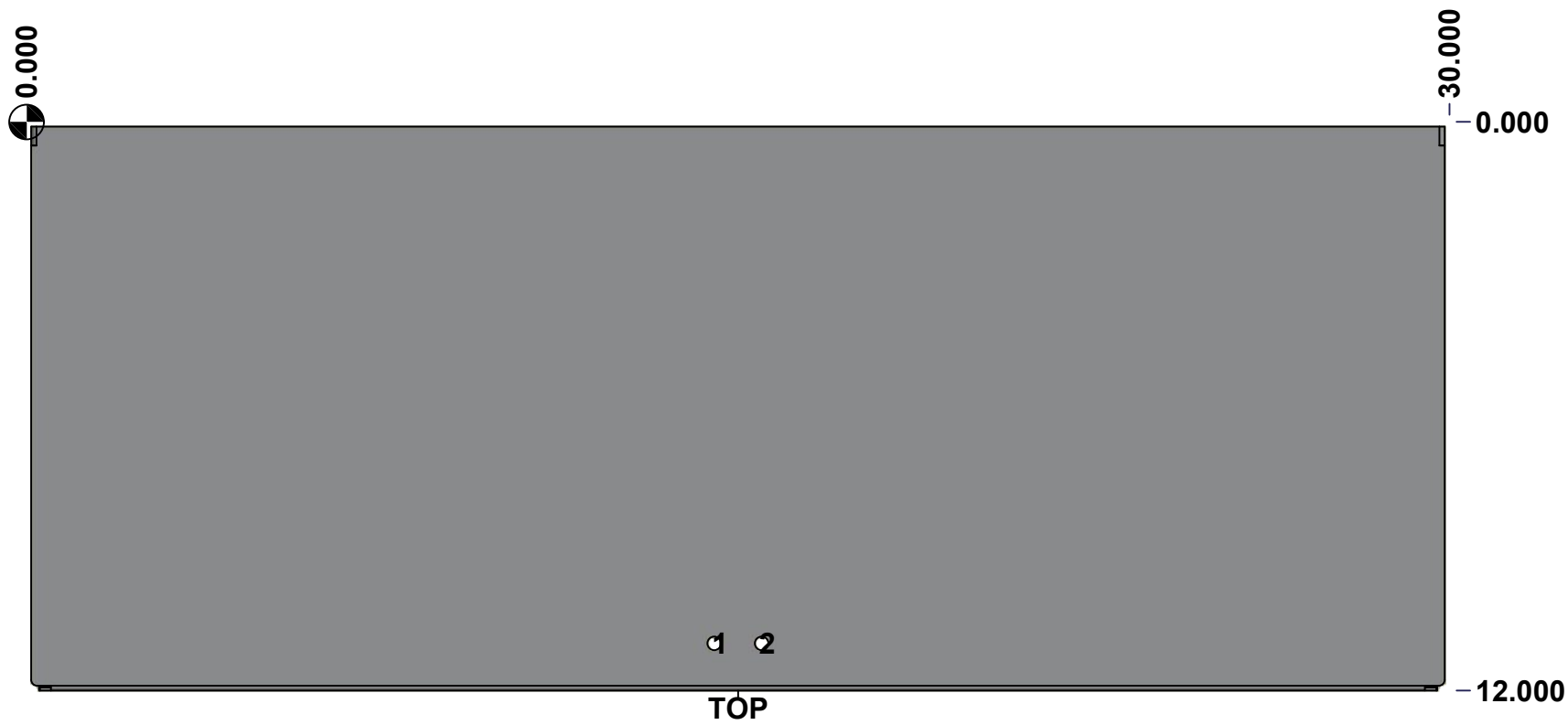

	Description	Status	
	1100DFPN 30" x 30" x 12" Body	(NULL)	
	Part Number Numéro Pièce	Rev.	4
	<b>1100DFP303012NB</b>	<b>0</b>	10

This drawing is confidential and must not be reproduced or used without the consent of EXM

Ce dessin est confidentiel et ne doit pas être reproduit ou utilisé sans le consentement de EXM

<b>STANDARD FEATURES ARE NOT LISTED IN THIS HOLE TABLE</b>			
<b>HOLE TABLE - BOTTOM VIEW (CUSTOM FEATURE ONLY)</b>			
CUT-OUT	XDIM	YDIM	DESCRIPTION
1	14.500	11.000	RND Ø0.290
2	15.500	11.000	RND Ø0.290

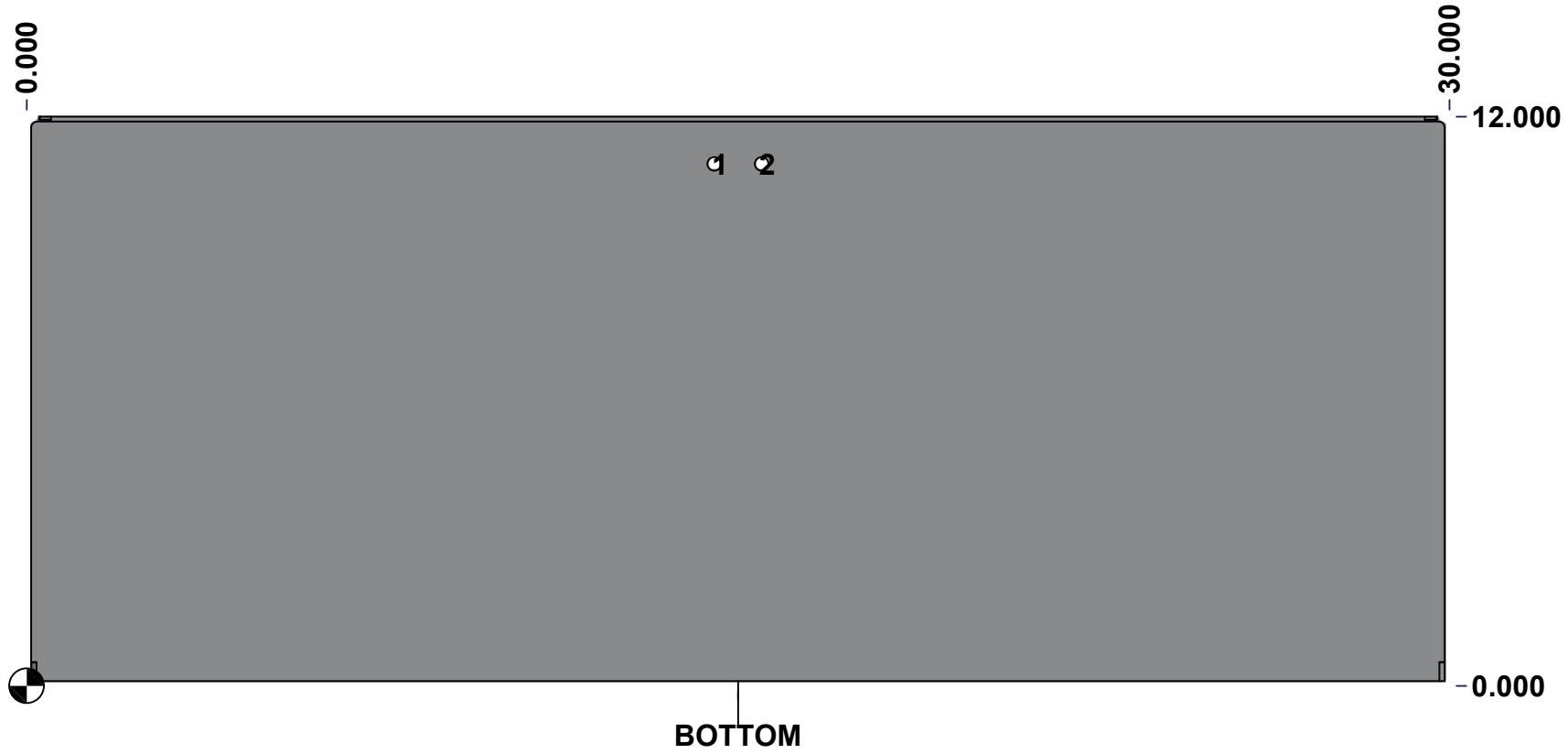

BOTTOM

	Description	Status	
	1100DFPN 30" x 30" x 12" Body	(NULL)	
	Part Number Numéro Pièce	Rev.	
	<b>1100DFP303012NBB</b>	<b>0</b>	5 10

This drawing is confidential and must not be reproduced or used without the consent of EXM

Ce dessin est confidentiel et ne doit pas être reproduit ou utilisé sans le consentement de EXM

STANDARD FEATURES ARE NOT LISTED IN THIS HOLE TABLE			
HOLE TABLE - BACK VIEW (CUSTOM FEATURE ONLY)			
CUT-OUT	XDIM	YDIM	DESCRIPTION
1	29.000	1.000	RND Ø0.290
2	29.000	29.000	RND Ø0.290
3	1.000	29.000	RND Ø0.290
4	1.000	1.000	RND Ø0.290

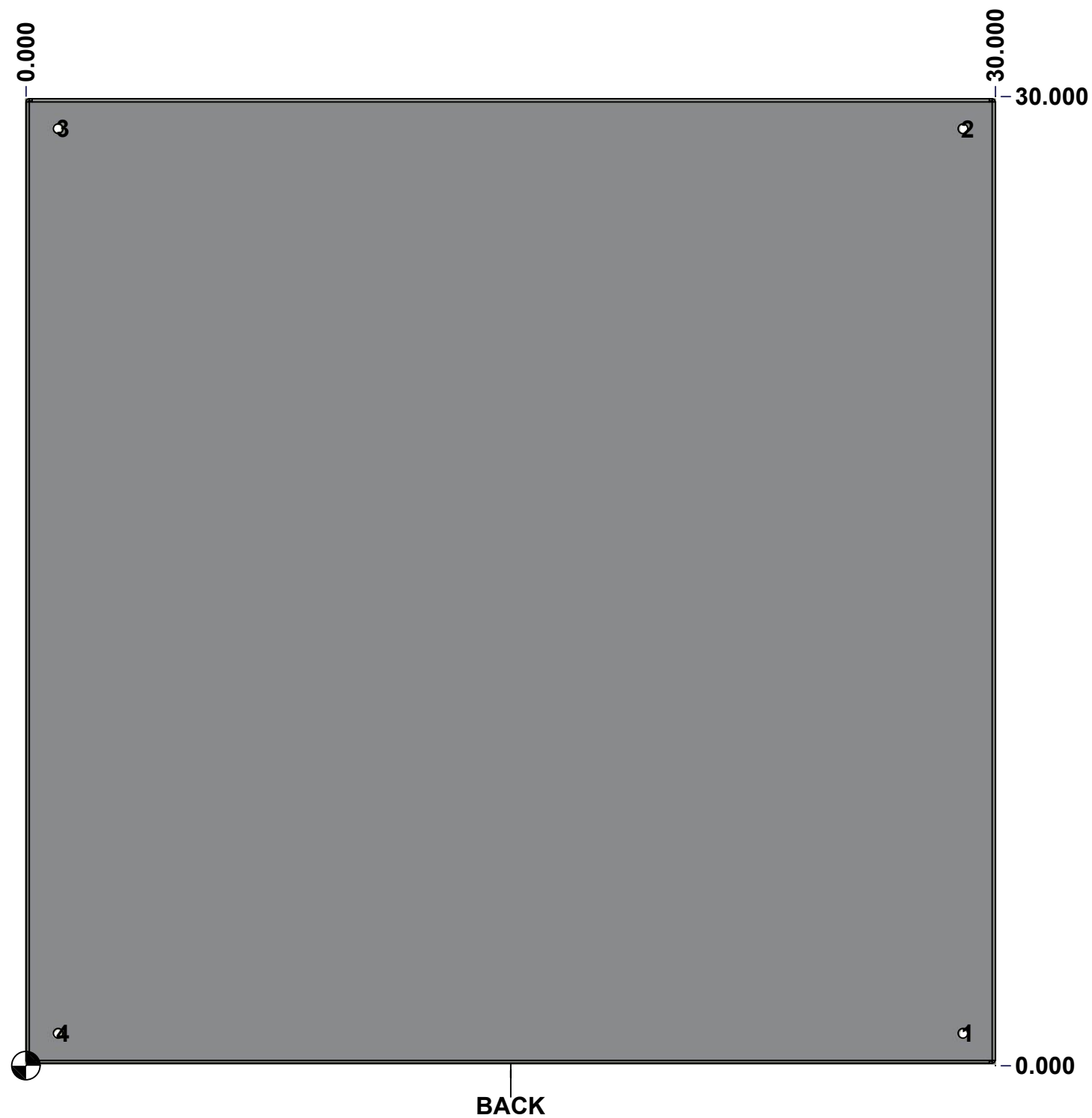

	Description	Status	
	1100DFPN 30" x 30" x 12" Body	(NULL)	
	Part Number Numéro Pièce	Rev.	
	<b>1100DFP303012NB</b>	<b>0</b>	6 / 10

This drawing is confidential and must not be reproduced or used without the consent of EXM

Ce dessin est confidentiel et ne doit pas être reproduit ou utilisé sans le consentement de EXM

No.	Revisions	Date	By/Par

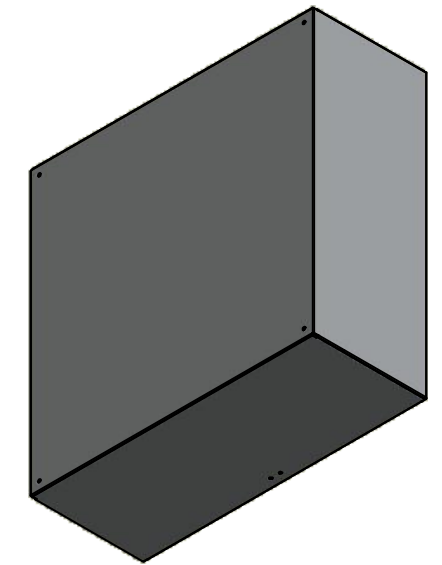

Isometric View



 Tél: (450) 979-4373 Fax: (450) 979-4626 <a href="http://www.exmweb.com">www.exmweb.com</a>		Flatness Aplatissement Max 3.0mm
Customer Client		Date
Drawn By / Dessiné Par: BoxCad: BoxCad		Date: 7/20/2022
Material / Matière: 14 Ga Cold Rolled A1008 CS Type B (1.7mm)		
Color / Couleur: Asa-61 Grey	Finish / Fini: Smooth	
Description: 1100DFPN 30" x 30" x 12" Body		Detail Rev.
Part Number / Numéro Pièce: <b>1100DFP303012NB</b>		Rev. 7 / 10

Qty	Part Number	Rev	Description
1	STK-P-02400S	0	Powder Paint (Asa-61 Grey / Smooth)
1	1100DFP303012NT-P	0	1100DFPN 30" x 30" x 12" Body Part
1	1100DFP303012NBT-P	0	1100DFPN 30" x 30" x 12" Body Part
1	1100DFP303012NB-P	0	1100DFPN 30" x 30" x 12" Body Part
Parts List			

This drawing is confidential and must not be reproduced or used without the consent of EXM

Ce dessin est confidentiel et ne doit pas être reproduit ou utilisé sans le consentement de EXM

TOP

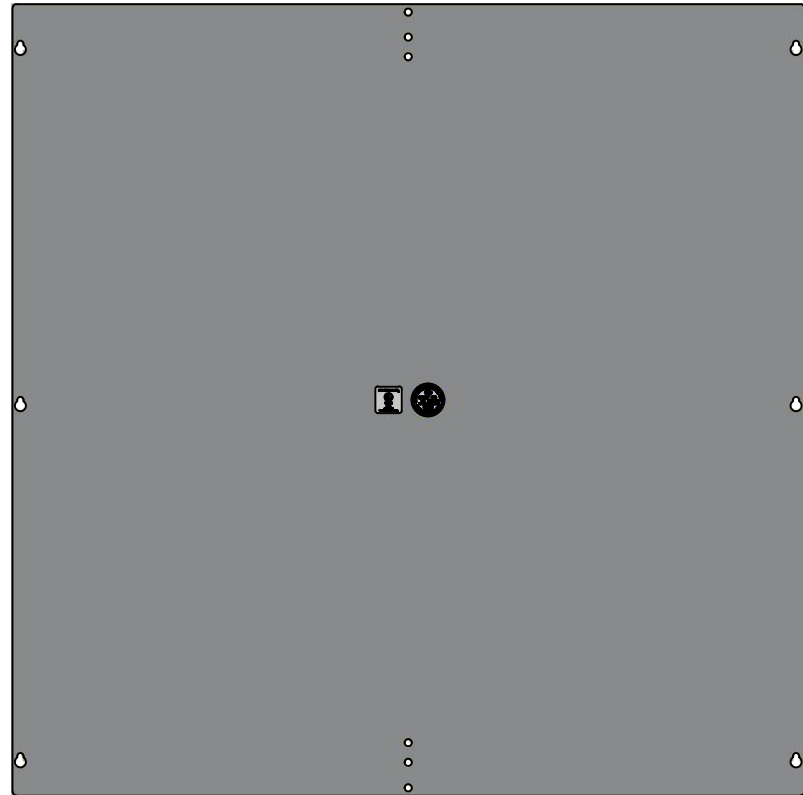

BACK

LEFT

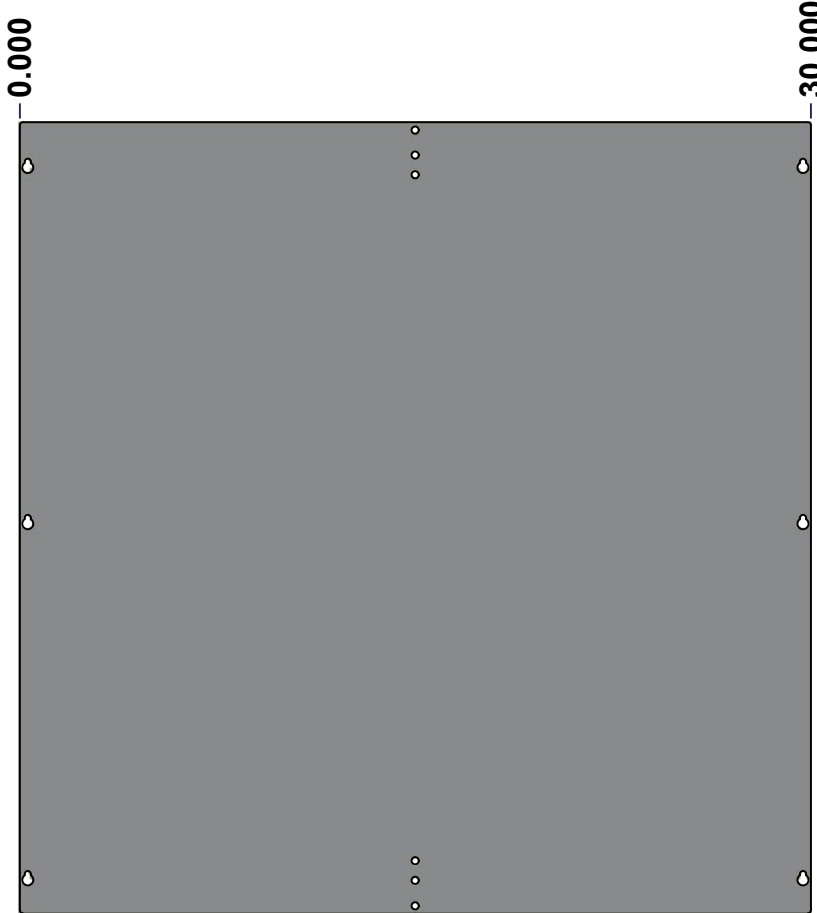

FRONT

RIGHT

No.	Revisions	Date	By/Par

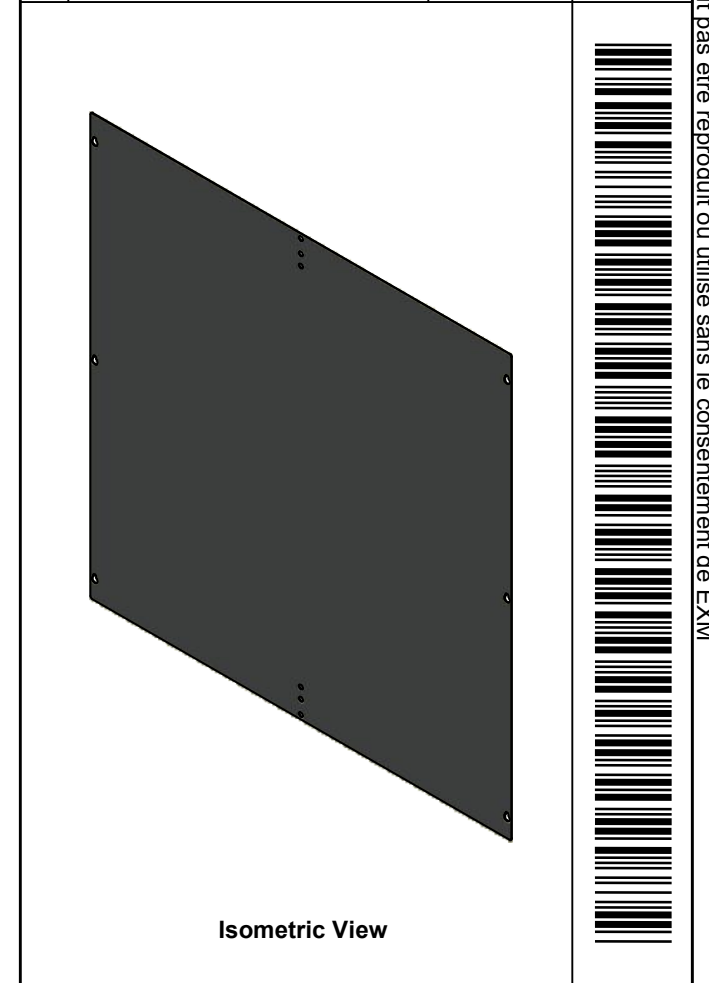

Isometric View

<p>Tél: (450) 979-4373                  Fax: (450) 979-4626  <a href="http://www.exmweb.com">www.exmweb.com</a></p>	Flatness Aplatissement	Max 3.0mm
	Projection	
Customer Client	Date	
Drawn By Dessiné Par	BoxCad: BoxCad	Date 7/20/2022
Material Matière	16 Ga Cold Rolled A1008 CS Type B (1.4mm)	
Color Couleur	Asa-61 Grey	Finish Fini Smooth
Description	1100DFPN 30" x 30" Cover	
Part Number Numéro Pièce	Rev. 0	8 / 10

SEE BILL OF MATERIAL ON LAST PAGE

**1100DFP303012NC**



This drawing is confidential and must not be reproduced or used without the consent of EXM

Ce dessin est confidentiel et ne doit pas être reproduit ou utilisé sans le consentement de EXM

STANDARD FEATURES ARE NOT LISTED IN THIS HOLE TABLE			
HOLE TABLE - FRONT VIEW (CUSTOM FEATURE ONLY)			
CUT-OUT	XDIM	YDIM	DESCRIPTION
1	15.000	28.750	RND Ø0.290
2	15.000	28.000	RND Ø0.290
3	15.000	2.000	RND Ø0.290
4	15.000	1.250	RND Ø0.290

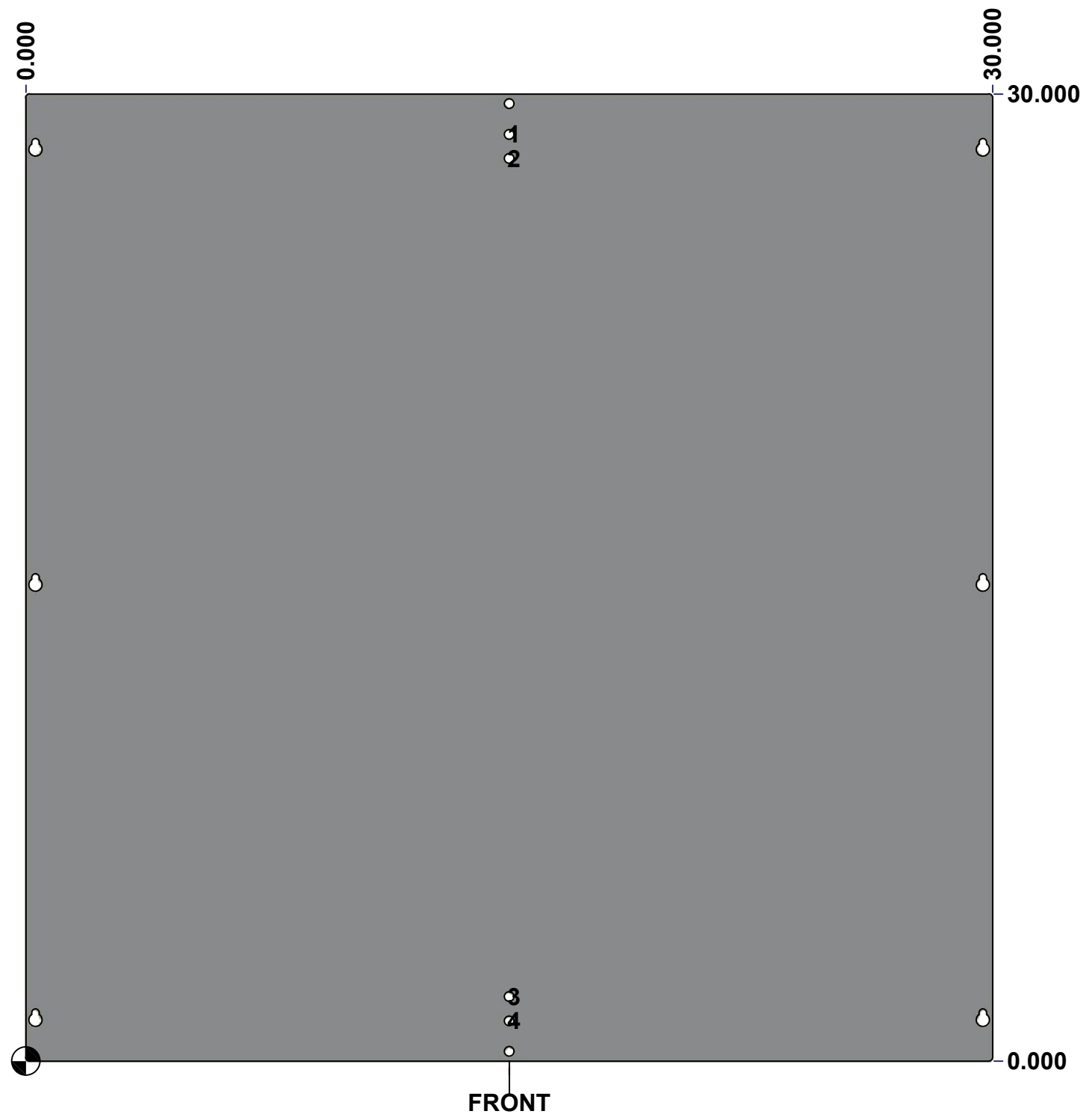



	Description	Status
	1100DFPN 30" x 30" Cover	(NULL)
Part Number Numéro Pièce <b>1100DFP303012NC</b>	Rev.	9
	<b>0</b>	10

This drawing is confidential and must not be reproduced or used without the consent of EXM

Ce dessin est confidentiel et ne doit pas être reproduit ou utilisé sans le consentement de EXM

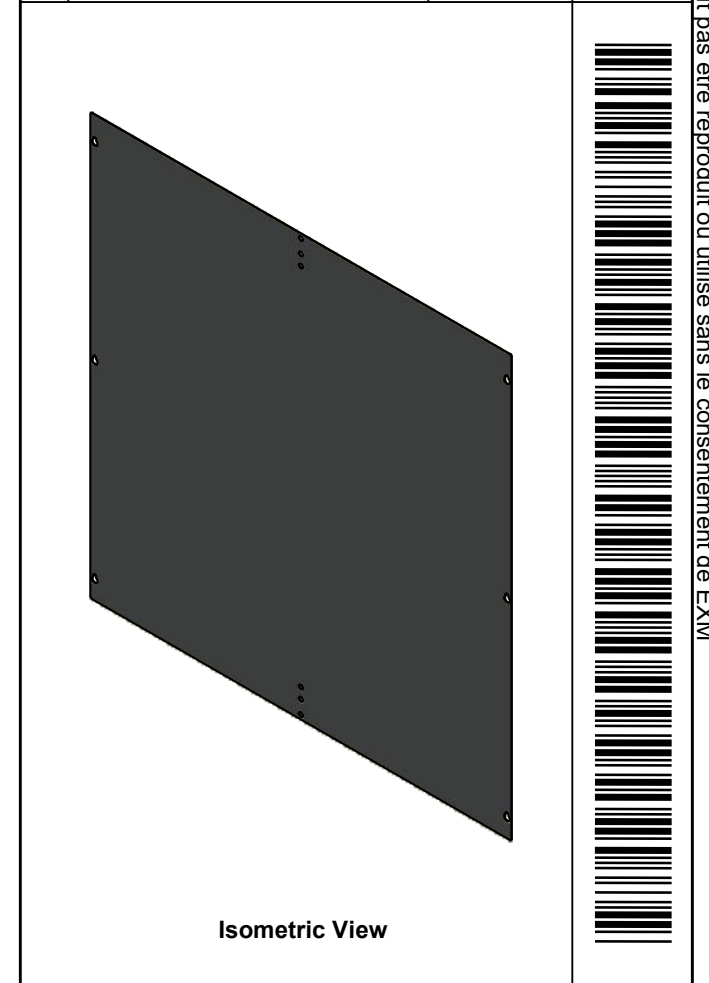
No.	Revisions	Date	By/Par

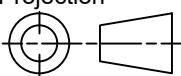

 Tél: (450) 979-4373 Fax: (450) 979-4626 <a href="http://www.exmweb.com">www.exmweb.com</a>		Flatness Aplatissement Max 3.0mm Projection 
Customer Client	Date	
Drawn By Dessiné Par	BoxCad: BoxCad	Date 7/20/2022
Material Matière	16 Ga Cold Rolled A1008 CS Type B (1.4mm)	
Color Couleur	Asa-61 Grey	Finish Fini Smooth
Description		Detail Rev.
1100DFPN 30" x 30" Cover		
Part Number Numéro Pièce	Rev.	10
<b>1100DFP303012NC</b>	<b>0</b>	10

Qty	Part Number	Rev	Description
1	STK-S-00950	1	UL 74SL Pull-Box Sticker
1	STK-S-00800	2	CSA Electrical Box Sticker
1	1100DFP303012NC-P	0	1100DFPN 30" x 30" Cover Part
1	STK-P-02400S	0	Powder Paint (Asa-61 Grey / Smooth)
Parts List			