

This drawing is confidential and must not be reproduced or used without the consent of EXM

Ce dessin est confidentiel et ne doit pas être reproduit ou utilisé sans le consentement de EXM

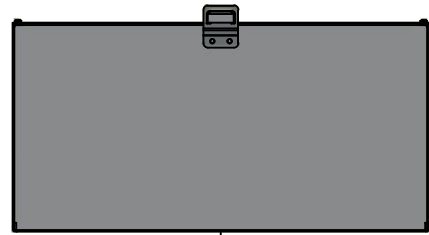

TOP

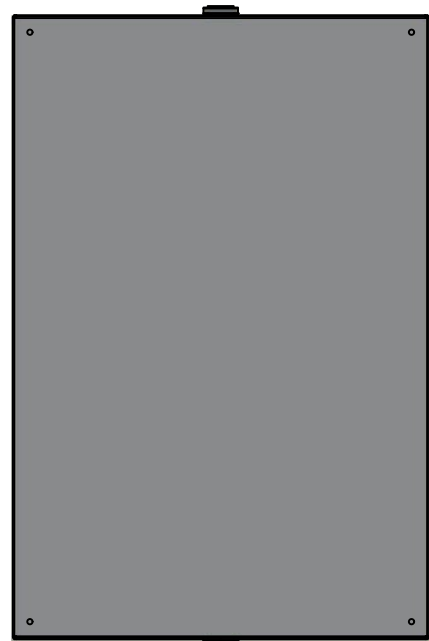

BACK

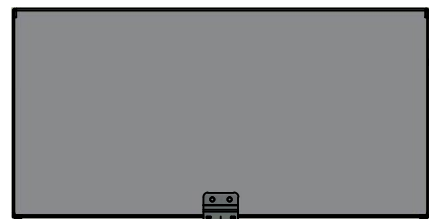

BOTTOM

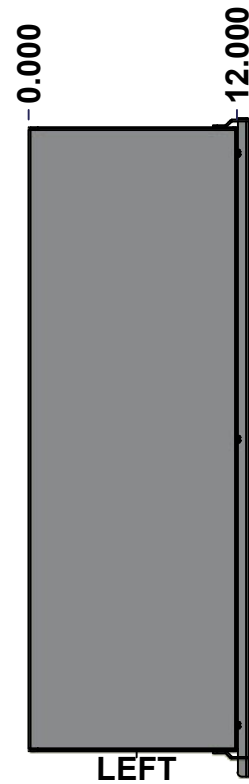

LEFT

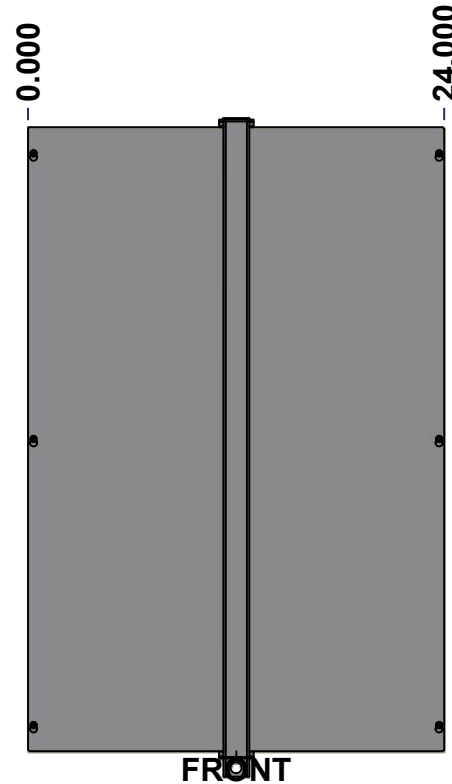

FRONT

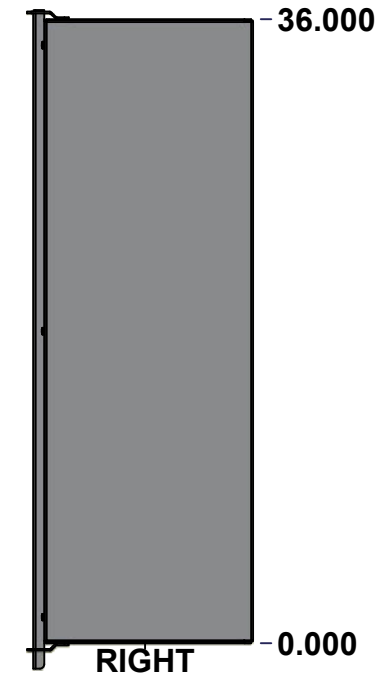

RIGHT

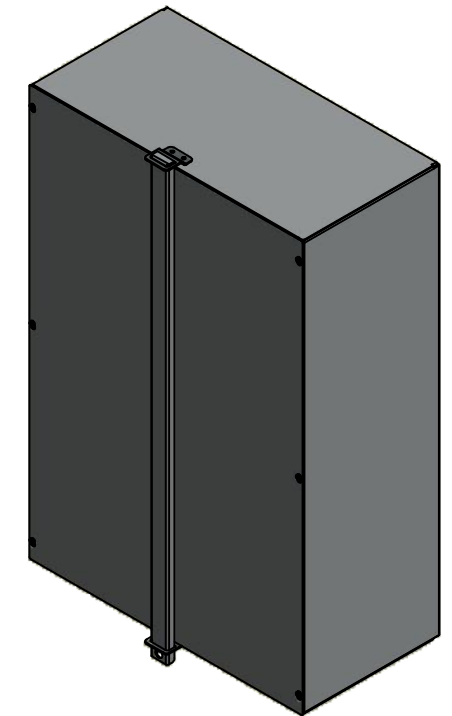

Isometric View

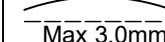
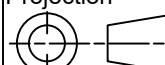

| No. | Revisions | Date | By/Par |
|-----|-----------|------|--------|
| | | | |
| | | | |
| | | | |
| | | | |

| | | |
|--|---|---|
|  Tél: (450) 979-4373 Fax: (450) 979-4626 www.exmweb.com | | Flatness Aplatissement  Max 3.0mm Projection  |
| Customer Client | Date | |
| Drawn By Dessiné Par | BoxCad: BoxCad | Date 7/20/2022 |
| Material Matière | 14 Ga Cold Rolled A1008 CS Type B (1.7mm) | |
| Color Couleur | Asa-61 Grey | Finish Fini Smooth |
| Description 1100DFPN 36" x 24" x 12" Assembly | | Detail Rev. |
| Part Number Numéro Pièce | 1100DFP362412N | Rev. 1 0 |

SEE BILL OF MATERIAL ON LAST PAGE

This drawing is confidential and must not be reproduced or used without the consent of EXM

Ce dessin est confidentiel et ne doit pas être reproduit ou utilisé sans le consentement de EXM

| NOTE | |
|------|--|
| ITEM | DESCRIPTION |
| 1 | NEMA 1 Enclosure |
| 2 | C/W Standard ground provision on box and cover |
| 3 | W/O Standard door stiffener |
| 4 | W/O Inner panel |
| 5 | W/O Inner panel mounting provision |
| 6 | C/W Padlock Kit (Not Installed) |

| No. | Revisions | Date | By/Par |
|-----|-----------|------|--------|
| | | | |
| | | | |
| | | | |
| | | | |
| | | | |
| | | | |

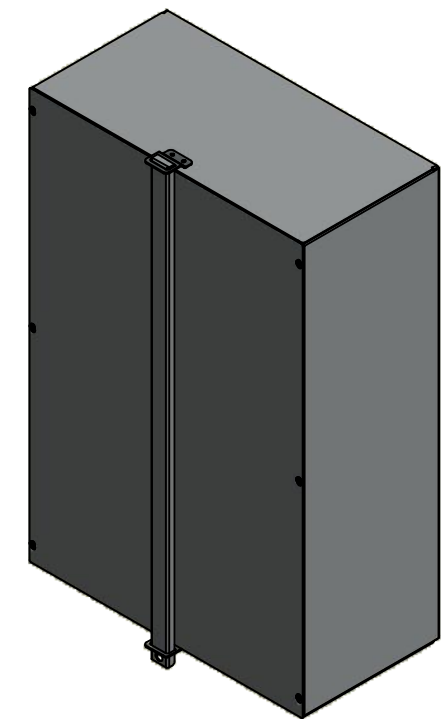

Isometric View

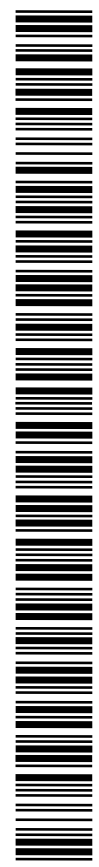

| PACKING | | |
|-----------------------|-----|--|
| ITEM | QTY | DESCRIPTION |
| Cardboard sleeve | 2 | Top and Bottom |
| Plastic strap - Black | 2 | To squeeze the 2 cardboard sleeve together |
| Thermal plastic film | 1 | Use with Packing Tunnel Wrapper Machine |
| Packaging label | 1 | White label with product number |

| Qty | Part Number | Rev | Description |
|------------|-----------------|-----|-------------------------------|
| 1 | 880 DPF36 | 0 | 880 DFP Padlock Kit |
| 6 | STK-Q-05020 | 5 | M5 x 8mm Thread Rolling Screw |
| 1 | 1100DFP362412NC | 0 | 1100DFPN 36" x 24" Cover |
| 1 | 1100DFP362412NB | 0 | 1100DFPN 36" x 24" x 12" Body |
| Parts List | | | |

| | | |
|---|--|--|
| | Tél: (450) 979-4373 Fax: (450) 979-4626 www.exmweb.com | Flatness Aplatissement Max 3.0mm |
| | | Projection |
| Customer Client | Date | |
| Drawn By Dessiné Par BoxCad: BoxCad | Date 7/20/2022 | |
| Material Matière 14 Ga Cold Rolled A1008 CS Type B (1.7mm) | | |
| Color Couleur Asa-61 Grey | Finish Fini Smooth | |
| Description 1100DFPN 36" x 24" x 12" Assembly | Detail Rev. | |
| Part Number Numéro Pièce 1100DFP362412N | Rev. 0 | 2 / 10 |

This drawing is confidential and must not be reproduced or used without the consent of EXM

Ce dessin est confidentiel et ne doit pas être reproduit ou utilisé sans le consentement de EXM

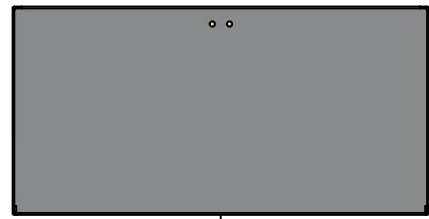

TOP

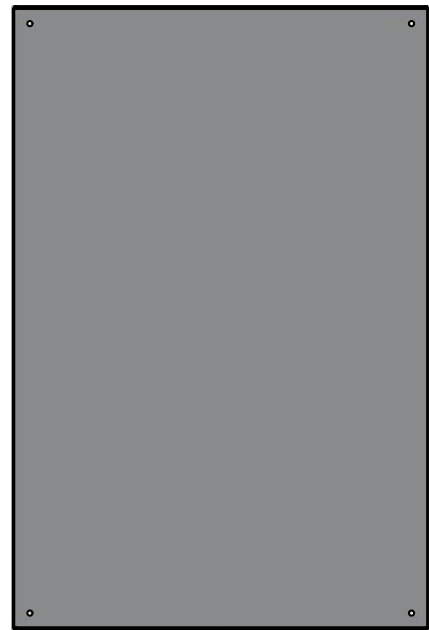

BACK



BOTTOM

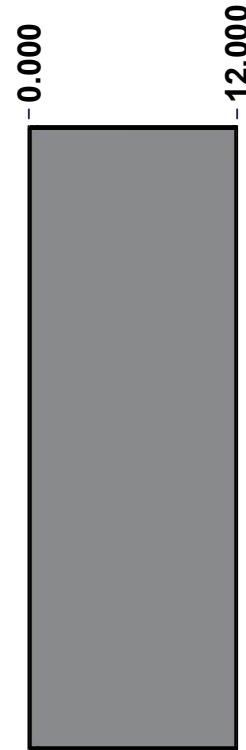

LEFT

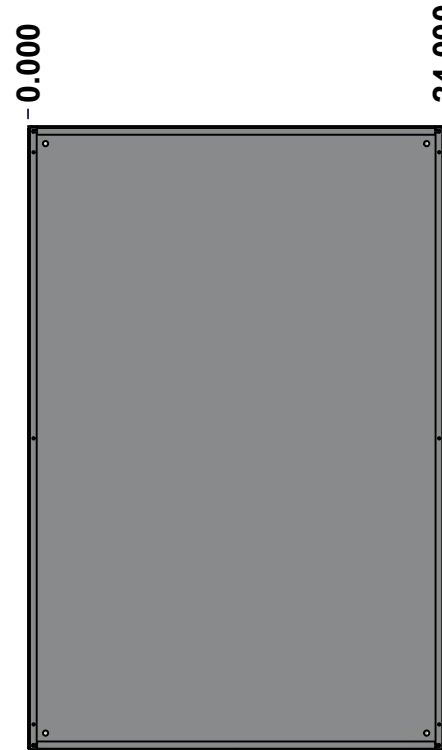

FRONT

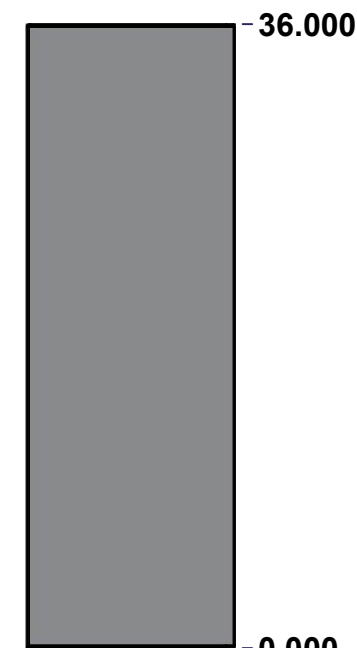

RIGHT

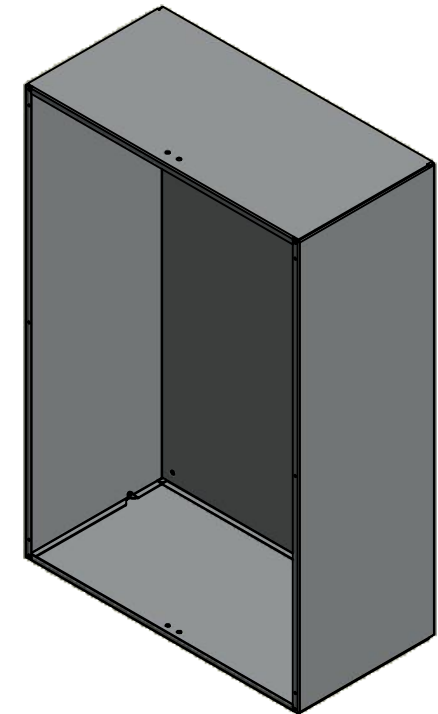

Isometric View

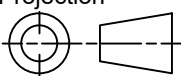

| No. | Revisions | Date | By/Par |
|-----|-----------|------|--------|
| | | | |
| | | | |
| | | | |
| | | | |
| | | | |

| | | |
|--|---|---|
|  Tél: (450) 979-4373 Fax: (450) 979-4626 www.exmweb.com | | Flatness Aplatissement Max 3.0mm Projection  |
| Customer Client | Date | |
| Drawn By Dessiné Par | BoxCad: BoxCad | Date 7/20/2022 |
| Material Matière | 14 Ga Cold Rolled A1008 CS Type B (1.7mm) | |
| Color Couleur | Asa-61 Grey | Finish Fini Smooth |
| Description | Detail Rev. | |
| 1100DFPN 36" x 24" x 12" Body | | |
| Part Number Numéro Pièce | Rev. | 3 |
| 1100DFP362412NB | 0 | 10 |

SEE BILL OF MATERIAL ON LAST PAGE

This drawing is confidential and must not be reproduced or used without the consent of EXM

Ce dessin est confidentiel et ne doit pas être reproduit ou utilisé sans le consentement de EXM

| STANDARD FEATURES ARE NOT LISTED IN THIS HOLE TABLE | | | |
|---|--------|--------|-------------|
| HOLE TABLE - TOP VIEW (CUSTOM FEATURE ONLY) | | | |
| CUT-OUT | XDIM | YDIM | DESCRIPTION |
| 1 | 11.500 | 11.000 | RND Ø0.290 |
| 2 | 12.500 | 11.000 | RND Ø0.290 |



| | | | |
|--|-------------------------------|----------|--------|
| | Description | Status | |
| | 1100DFPN 36" x 24" x 12" Body | (NULL) | |
| | Part Number Numéro Pièce | Rev. | |
| | 1100DFP362412NB | 0 | 4 / 10 |

This drawing is confidential and must not be reproduced or used without the consent of EXM

Ce dessin est confidentiel et ne doit pas être reproduit ou utilisé sans le consentement de EXM

| STANDARD FEATURES ARE NOT LISTED IN THIS HOLE TABLE | | | |
|--|--------|--------|-------------|
| HOLE TABLE - BOTTOM VIEW (CUSTOM FEATURE ONLY) | | | |
| CUT-OUT | XDIM | YDIM | DESCRIPTION |
| 1 | 11.500 | 11.000 | RND Ø0.290 |
| 2 | 12.500 | 11.000 | RND Ø0.290 |

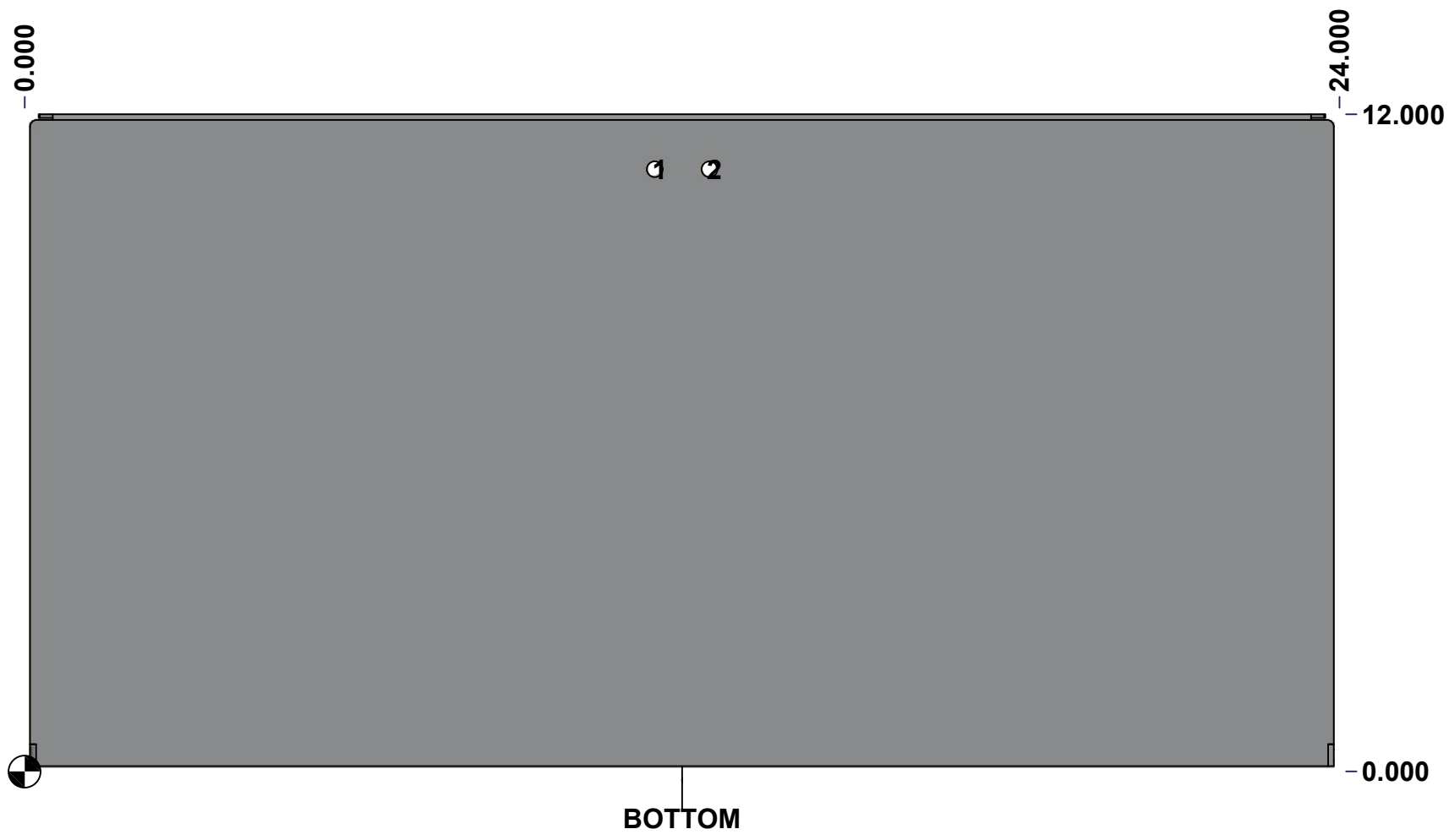

| | | | |
|--|-------------------------------|----------|----|
| | Description | Status | |
| | 1100DFPN 36" x 24" x 12" Body | (NULL) | |
| | Part Number Numéro Pièce | Rev. | 5 |
| | 1100DFP362412NBB | 0 | 10 |

This drawing is confidential and must not be reproduced or used without the consent of EXM

Ce dessin est confidentiel et ne doit pas être reproduit ou utilisé sans le consentement de EXM

| STANDARD FEATURES ARE NOT LISTED IN THIS HOLE TABLE | | | |
|---|--------|--------|-------------|
| HOLE TABLE - BACK VIEW (CUSTOM FEATURE ONLY) | | | |
| CUT-OUT | XDIM | YDIM | DESCRIPTION |
| 1 | 23.000 | 1.000 | RND Ø0.290 |
| 2 | 23.000 | 35.000 | RND Ø0.290 |
| 3 | 1.000 | 35.000 | RND Ø0.290 |
| 4 | 1.000 | 1.000 | RND Ø0.290 |

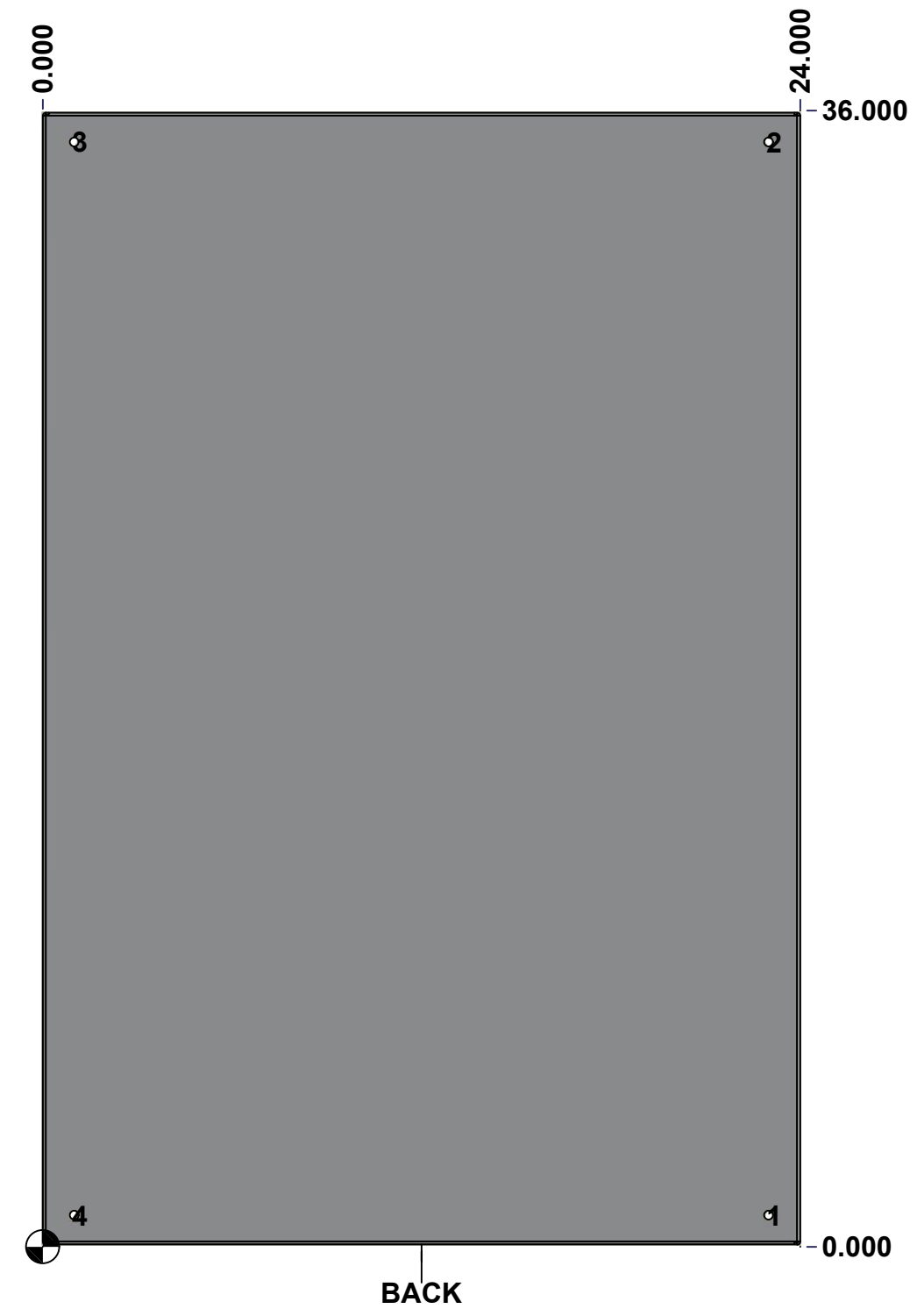

BACK

| | | | |
|--|-------------------------------|----------|--------|
| | Description | Status | |
| | 1100DFPN 36" x 24" x 12" Body | (NULL) | |
| | Part Number Numéro Pièce | Rev. | |
| | 1100DFP362412NB | 0 | 6 / 10 |

This drawing is confidential and must not be reproduced or used without the consent of EXM

Ce dessin est confidentiel et ne doit pas être reproduit ou utilisé sans le consentement de EXM

| No. | Revisions | Date | By/Par |
|-----|-----------|------|--------|
| | | | |
| | | | |
| | | | |
| | | | |
| | | | |

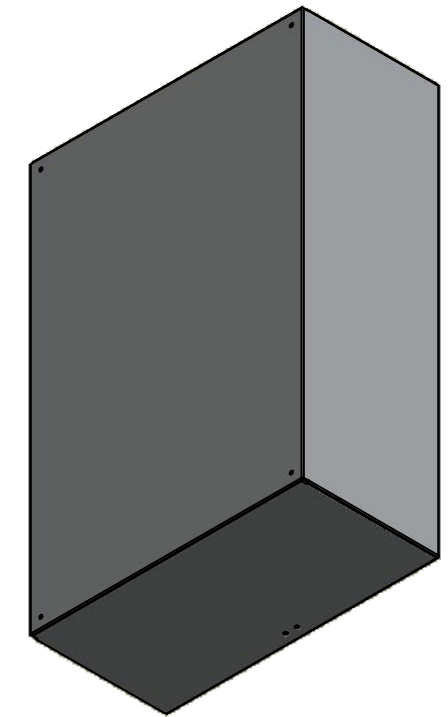

Isometric View

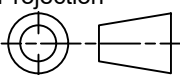

| | | |
|--|---|---|
|  Tél: (450) 979-4373 Fax: (450) 979-4626 www.exmweb.com | | Flatness Aplatissement Max 3.0mm Projection  |
| Customer Client | Date | |
| Drawn By Dessiné Par | BoxCad: BoxCad | Date 7/20/2022 |
| Material Matière | 14 Ga Cold Rolled A1008 CS Type B (1.7mm) | |
| Color Couleur | Asa-61 Grey | Finish Fini Smooth |
| Description | | Detail Rev. |
| 1100DFPN 36" x 24" x 12" Body | | |
| Part Number Numéro Pièce | Rev. | 7 |
| 1100DFP362412NB | 0 | 10 |

| Qty | Part Number | Rev | Description |
|------------|--------------------|-----|-------------------------------------|
| 1 | STK-P-02400S | 0 | Powder Paint (Asa-61 Grey / Smooth) |
| 1 | 1100DFP362412NT-P | 0 | 1100DFPN 36" x 24" x 12" Body Part |
| 1 | 1100DFP362412NBT-P | 0 | 1100DFPN 36" x 24" x 12" Body Part |
| 1 | 1100DFP362412NB-P | 0 | 1100DFPN 36" x 24" x 12" Body Part |
| Parts List | | | |

This drawing is confidential and must not be reproduced or used without the consent of EXM

Ce dessin est confidentiel et ne doit pas être reproduit ou utilisé sans le consentement de EXM

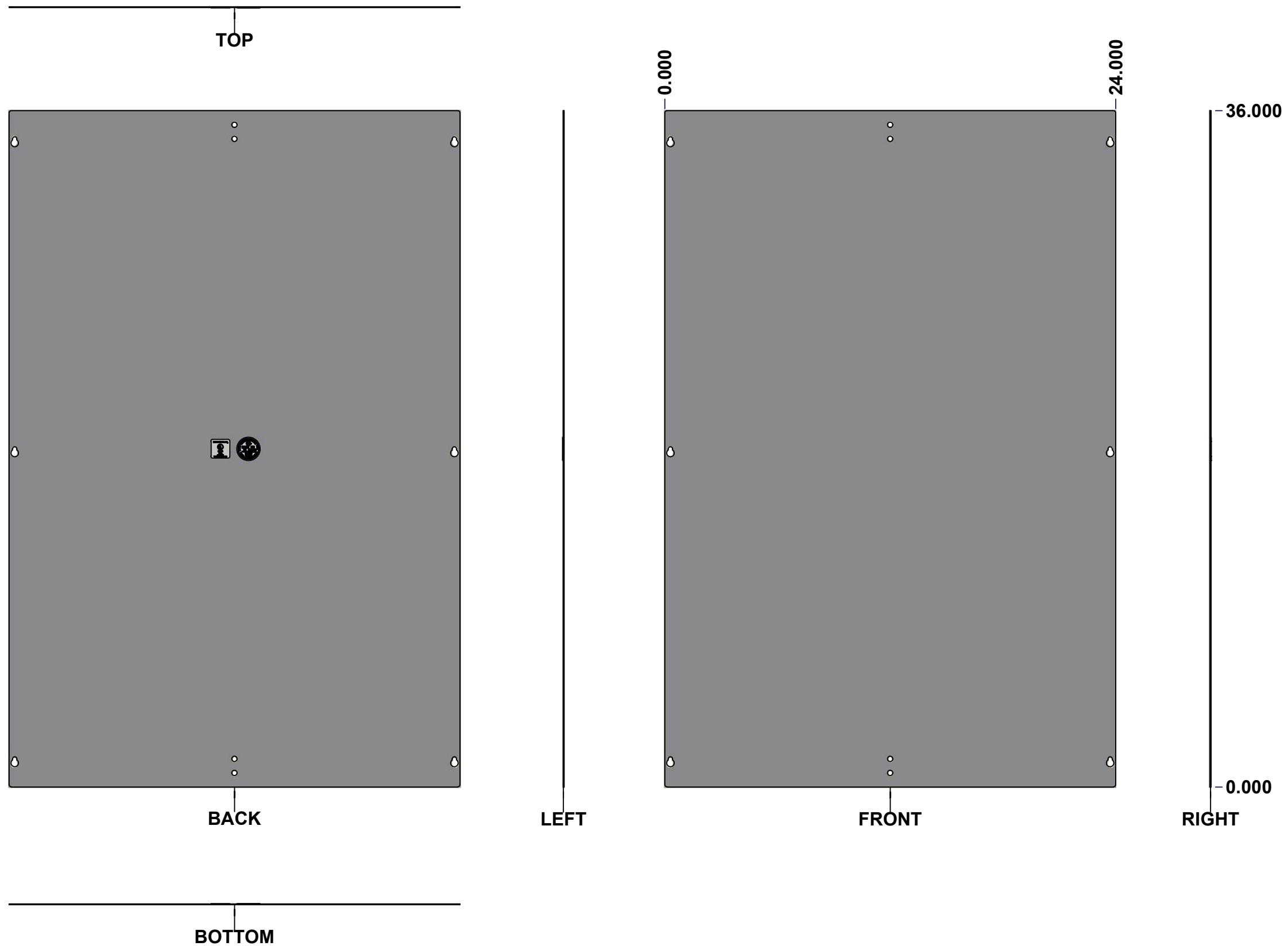

| No. | Revisions | Date | By/Par |
|-----|-----------|------|--------|
| | | | |
| | | | |
| | | | |
| | | | |
| | | | |

Isometric View

| | | |
|--|---|---------------------------|
| Tél: (450) 979-4373 Fax: (450) 979-4626 www.exmweb.com | | Flatness Aplatissement |
| | | Max 3.0mm |
| Projection | | |
| Customer Client | | Date |
| Drawn By Dessiné Par | BoxCad: BoxCad | Date 7/20/2022 |
| Material Matière | 16 Ga Cold Rolled A1008 CS Type B (1.4mm) | |
| Color Couleur | Asa-61 Grey | Finish Fini Smooth |
| Description | | Detail Rev. |
| 1100DFPN 36" x 24" Cover | | |
| Part Number Numéro Pièce | Rev. | 8 |
| 1100DFP362412NC | 0 | 10 |

SEE BILL OF MATERIAL ON LAST PAGE

This drawing is confidential and must not be reproduced or used without the consent of EXM

Ce dessin est confidentiel et ne doit pas être reproduit ou utilisé sans le consentement de EXM

| STANDARD FEATURES ARE NOT LISTED IN THIS HOLE TABLE | | | |
|---|--------|--------|-------------|
| HOLE TABLE - FRONT VIEW (CUSTOM FEATURE ONLY) | | | |
| CUT-OUT | XDIM | YDIM | DESCRIPTION |
| 1 | 12.000 | 35.250 | RND Ø0.290 |
| 2 | 12.000 | 34.500 | RND Ø0.290 |
| 3 | 12.000 | 1.500 | RND Ø0.290 |
| 4 | 12.000 | 0.750 | RND Ø0.290 |

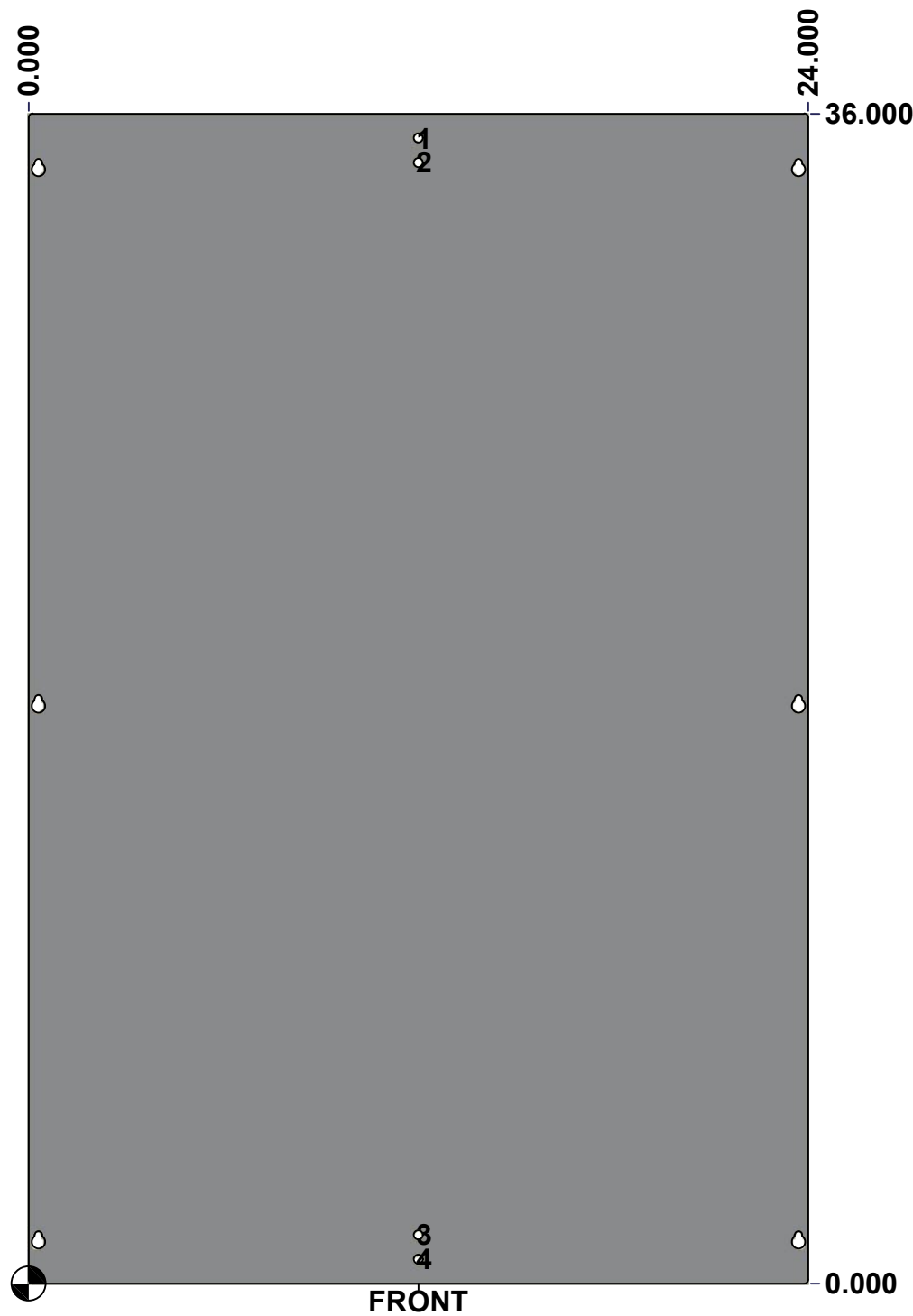



| | | | |
|--|-----------------------------|----------|---------|
| | Description | Status | |
| | 1100DFPN 36" x 24" Cover | (NULL) | |
| | Part Number Numéro Pièce | Rev. | |
| | 1100DFP362412NC | 0 | 9 10 |

This drawing is confidential and must not be reproduced or used without the consent of EXM

Ce dessin est confidentiel et ne doit pas être reproduit ou utilisé sans le consentement de EXM

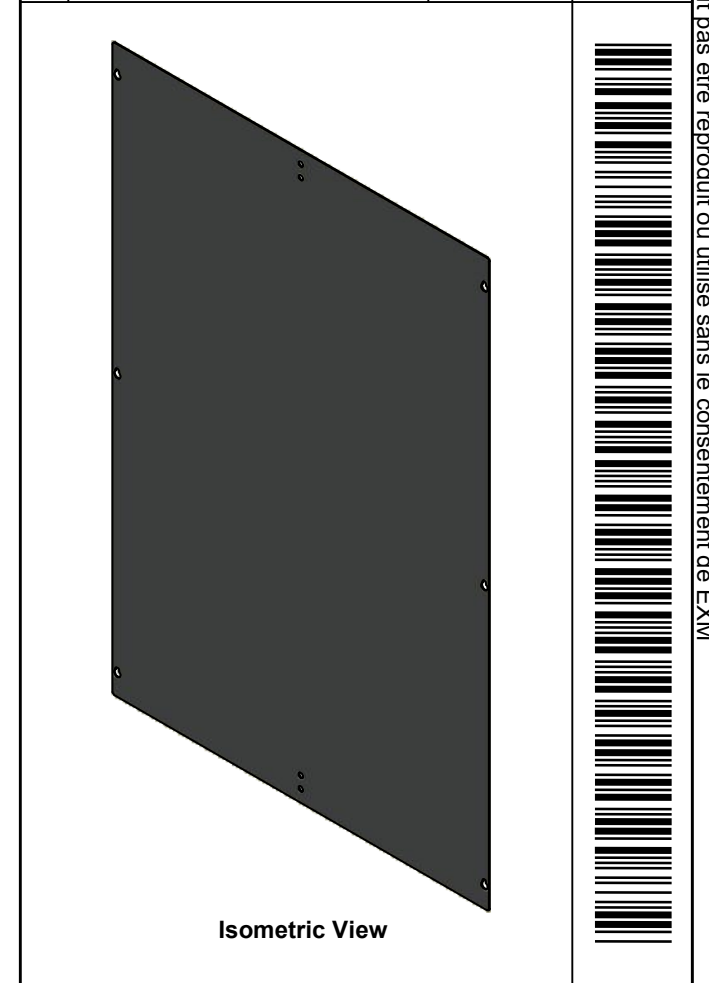
| No. | Revisions | Date | By/Par |
|-----|-----------|------|--------|
| | | | |
| | | | |
| | | | |
| | | | |
| | | | |

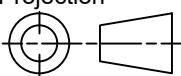

| | | |
|--|-----------------------|---|
|  Tél: (450) 979-4373 Fax: (450) 979-4626 www.exmweb.com | | Flatness Aplatissement Max 3.0mm Projection  |
| Customer Client | Date | |
| Drawn By / Dessiné Par: BoxCad: BoxCad | Date: 7/20/2022 | |
| Material / Matière: 16 Ga Cold Rolled A1008 CS Type B (1.4mm) | | |
| Color / Couleur: Asa-61 Grey | Finish / Fini: Smooth | |
| Description: 1100DFPN 36" x 24" Cover | | Detail Rev. |
| Part Number / Numéro Pièce: 1100DFP362412NC | Rev.: | 10 |
| | | 0 |
| | | 10 |

| Qty | Part Number | Rev | Description |
|------------|-------------------|-----|-------------------------------------|
| 1 | STK-S-00950 | 1 | UL 74SL Pull-Box Sticker |
| 1 | STK-S-00800 | 2 | CSA Electrical Box Sticker |
| 1 | 1100DFP362412NC-P | 0 | 1100DFPN 36" x 24" Cover Part |
| 1 | STK-P-02400S | 0 | Powder Paint (Asa-61 Grey / Smooth) |
| Parts List | | | |