

This drawing is confidential and must not be reproduced or used without the consent of EXM

Ce dessin est confidentiel et ne doit pas être reproduit ou utilisé sans le consentement de EXM

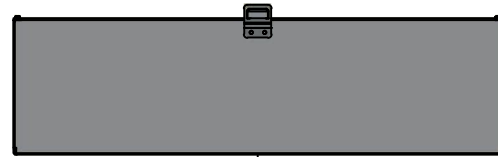

TOP



BACK

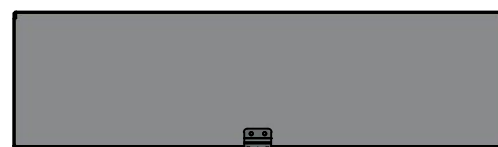

BOTTOM

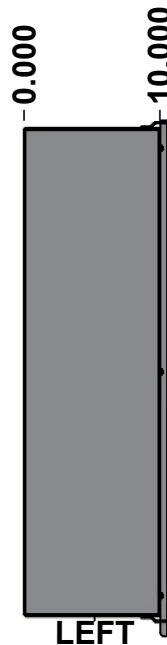

LEFT

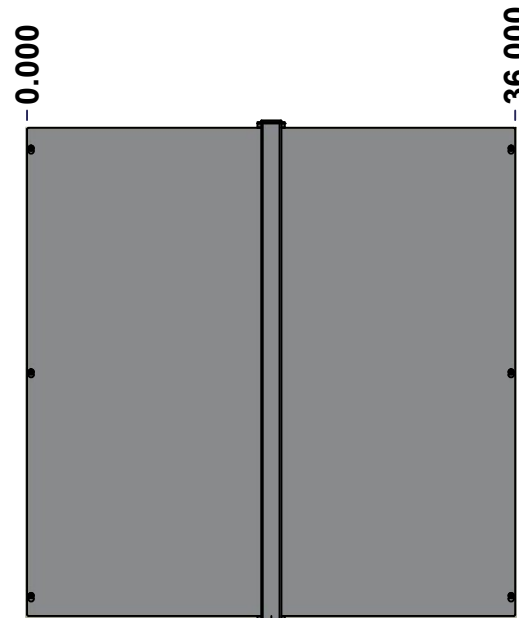

FRONT

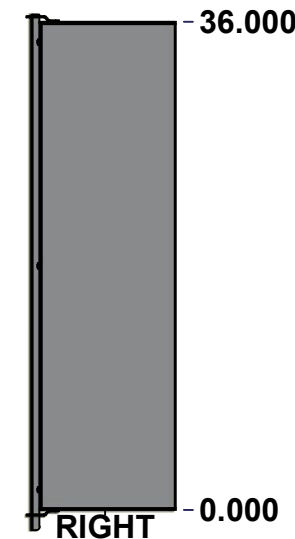

RIGHT

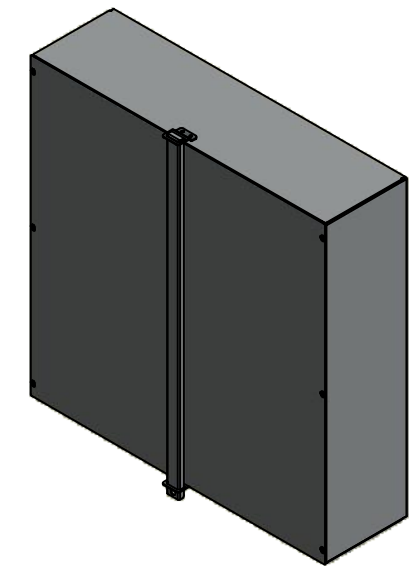

Isometric View

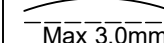
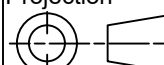

No.	Revisions	Date	By/Par

 Tél: (450) 979-4373 Fax: (450) 979-4626 www.exmweb.com		Flatness Aplatissement  Max 3.0mm Projection 
Customer Client		Date
Drawn By Dessiné Par	BoxCad: BoxCad	Date 7/19/2022
Material Matière	14 Ga Cold Rolled A1008 CS Type B (1.7mm)	
Color Couleur	Asa-61 Grey	Finish Fini Smooth
Description 1100DFPN 36" x 36" x 10" Assembly		Detail Rev.
Part Number Numéro Pièce	1100DFP363610N	Rev. 1 0

SEE BILL OF MATERIAL ON LAST PAGE

This drawing is confidential and must not be reproduced or used without the consent of EXM

Ce dessin est confidentiel et ne doit pas être reproduit ou utilisé sans le consentement de EXM

NOTE	
ITEM	DESCRIPTION
1	NEMA 1 Enclosure
2	C/W Standard ground provision on box and cover
3	W/O Standard door stiffener
4	W/O Inner panel
5	W/O Inner panel mounting provision
6	C/W Padlock Kit (Not Installed)

No.	Revisions	Date	By/Par

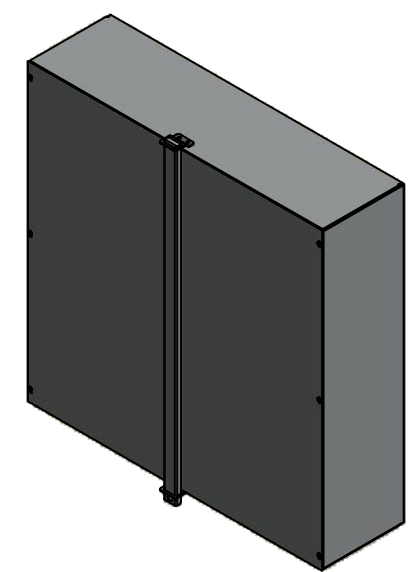

Isometric View

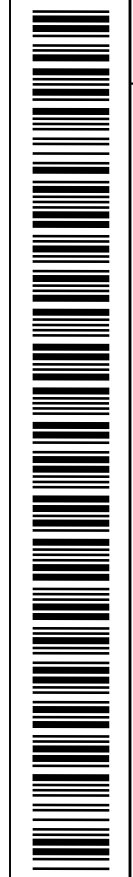

Tél: (450) 979-4373
 Fax: (450) 979-4626
www.exmweb.com

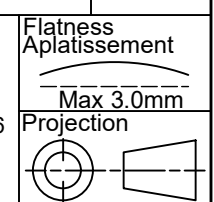

Customer Client	Date
Drawn By / Dessiné Par: BoxCad: BoxCad	Date: 7/19/2022
Material / Matière: 14 Ga Cold Rolled A1008 CS Type B (1.7mm)	

Color / Couleur: Asa-61 Grey	Finish / Fini: Smooth
------------------------------	-----------------------

Description: 1100DFPN 36" x 36" x 10" Assembly	Detail Rev.
--	-------------

Part Number / Numéro Pièce: 1100DFP363610N	Rev. 0	2 / 10
---	--------	--------

PACKING		
ITEM	QTY	DESCRIPTION
Cardboard sleeve	2	Top and Bottom
Plastic strap - Black	2	To squeeze the 2 cardboard sleeve together
Thermal plastic film	1	Use with Packing Tunnel Wrapper Machine
Packaging label	1	White label with product number

Qty	Part Number	Rev	Description
1	880 DPF36	0	880 DFP Padlock Kit
8	STK-Q-05020	5	M5 x 8mm Thread Rolling Screw
1	1100DFP363610NC	0	1100DFPN 36" x 36" Cover
1	1100DFP363610NB	0	1100DFPN 36" x 36" x 10" Body

Parts List

This drawing is confidential and must not be reproduced or used without the consent of EXM

Ce dessin est confidentiel et ne doit pas être reproduit ou utilisé sans le consentement de EXM



TOP

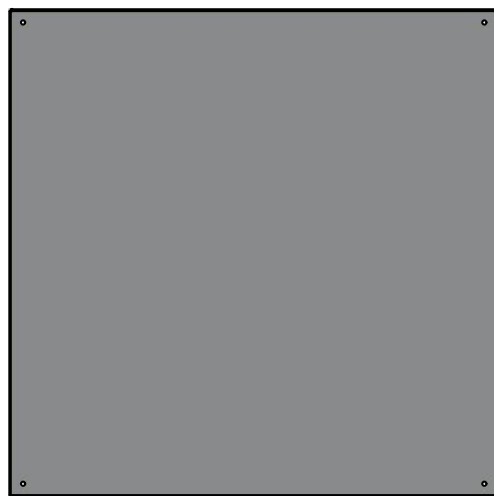

BACK



LEFT

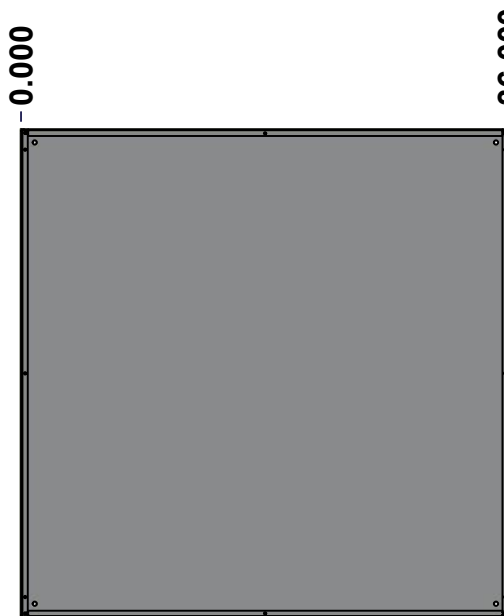

FRONT

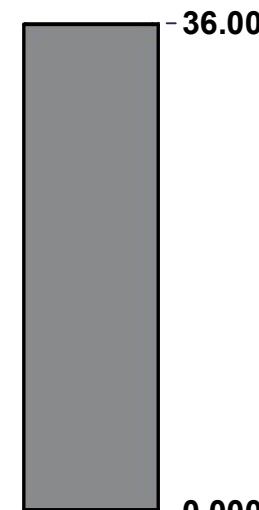

RIGHT



BOTTOM

No.	Revisions	Date	By/Par

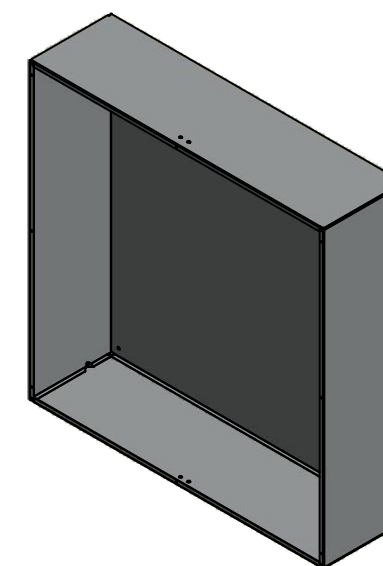

Isometric View



Tél: (450) 979-4373
 Fax: (450) 979-4626
www.exmweb.com

Flatness
Aplatissement

Max 3.0mm

Projection



Customer Client	Date
Drawn By / Dessiné Par: BoxCad: BoxCad	Date: 7/19/2022
Material / Matière: 14 Ga Cold Rolled A1008 CS Type B (1.7mm)	

Color / Couleur: Asa-61 Grey	Finish / Fini: Smooth
------------------------------	-----------------------

Description: 1100DFPN 36" x 36" x 10" Body	Detail Rev.
--	-------------

Part Number / Numéro Pièce: 1100DFP363610NB	Rev. 0	3	10
---	--------	---	----

SEE BILL OF MATERIAL ON LAST PAGE

This drawing is confidential and must not be reproduced or used without the consent of EXM

Ce dessin est confidentiel et ne doit pas être reproduit ou utilisé sans le consentement de EXM

STANDARD FEATURES ARE NOT LISTED IN THIS HOLE TABLE			
HOLE TABLE - TOP VIEW (CUSTOM FEATURE ONLY)			
CUT-OUT	XDIM	YDIM	DESCRIPTION
1	17.500	9.000	RND Ø0.290
2	18.500	9.000	RND Ø0.290

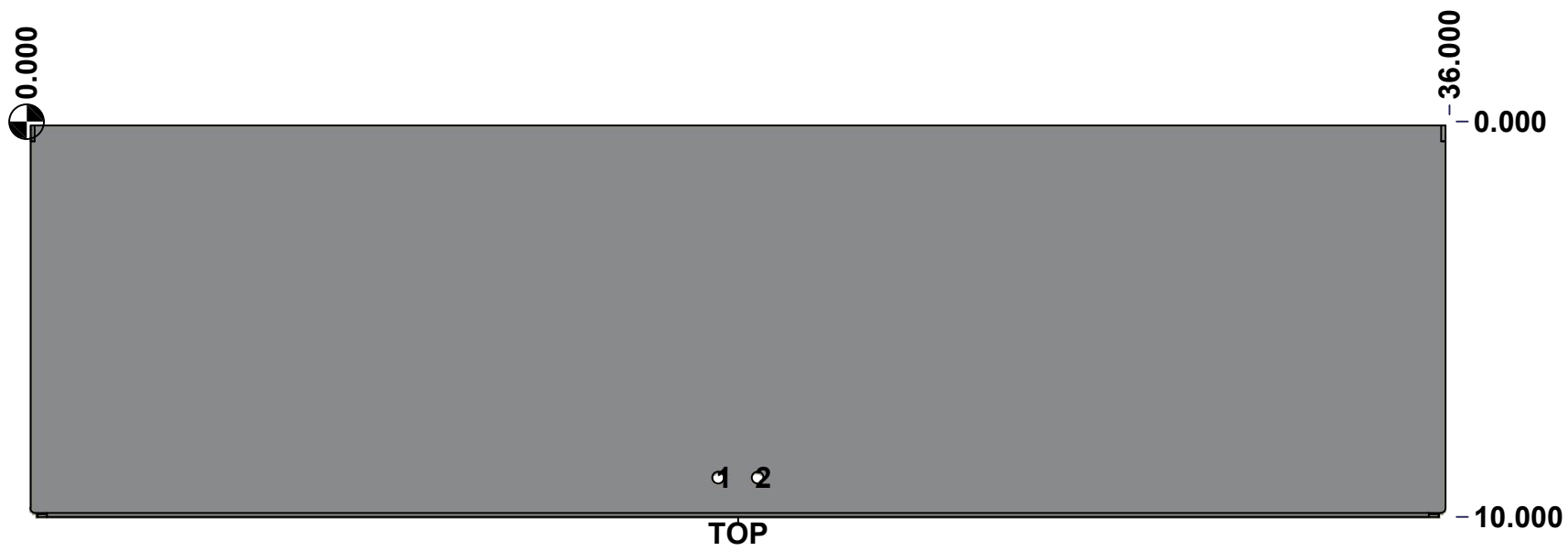

	Description	Status	
	1100DFPN 36" x 36" x 10" Body	(NULL)	
	Part Number Numéro Pièce	Rev.	
	1100DFP363610NB	0	4 / 10

This drawing is confidential and must not be reproduced or used without the consent of EXM

Ce dessin est confidentiel et ne doit pas être reproduit ou utilisé sans le consentement de EXM

STANDARD FEATURES ARE NOT LISTED IN THIS HOLE TABLE			
HOLE TABLE - BOTTOM VIEW (CUSTOM FEATURE ONLY)			
CUT-OUT	XDIM	YDIM	DESCRIPTION
1	17.500	9.000	RND Ø0.290
2	18.500	9.000	RND Ø0.290

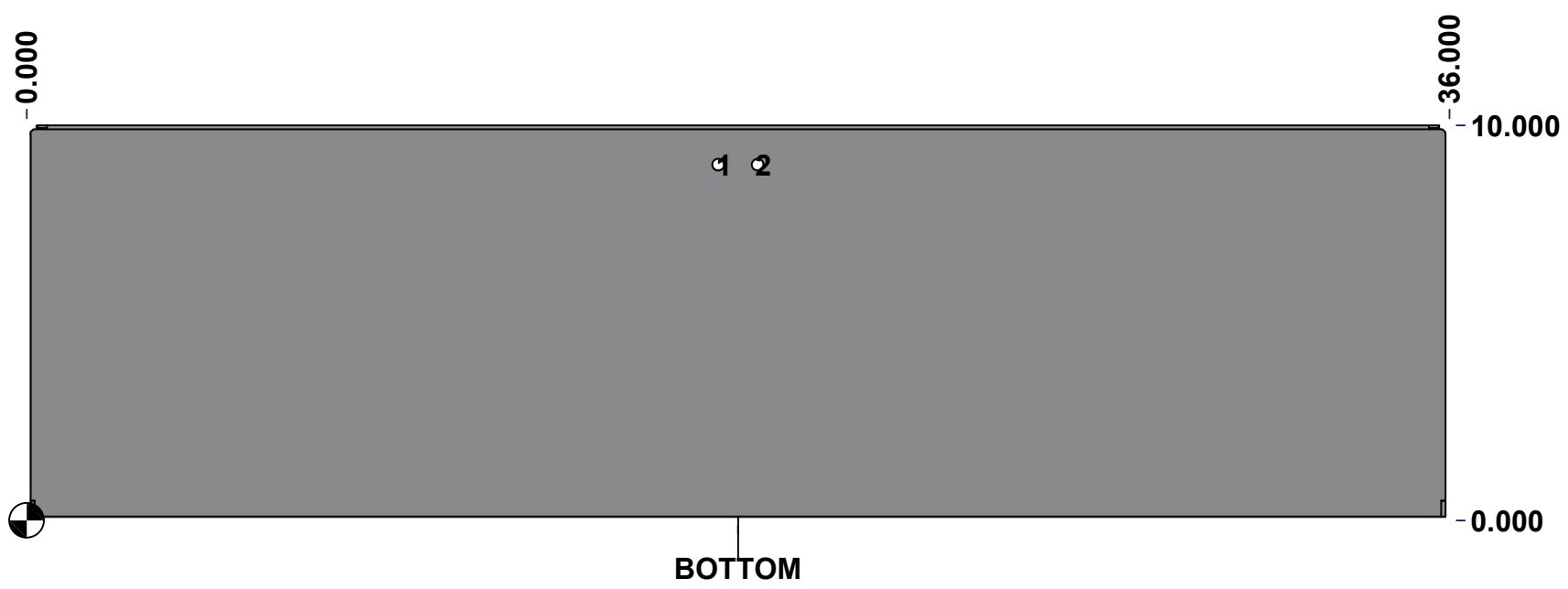

	Description	Status	
	1100DFPN 36" x 36" x 10" Body	(NULL)	
	Part Number Numéro Pièce	Rev.	
	1100DFP363610NBB	0	5 / 10

This drawing is confidential and must not be reproduced or used without the consent of EXM

Ce dessin est confidentiel et ne doit pas être reproduit ou utilisé sans le consentement de EXM

STANDARD FEATURES ARE NOT LISTED IN THIS HOLE TABLE			
HOLE TABLE - BACK VIEW (CUSTOM FEATURE ONLY)			
CUT-OUT	XDIM	YDIM	DESCRIPTION
1	35.000	1.000	RND Ø0.290
2	35.000	35.000	RND Ø0.290
3	1.000	35.000	RND Ø0.290
4	1.000	1.000	RND Ø0.290

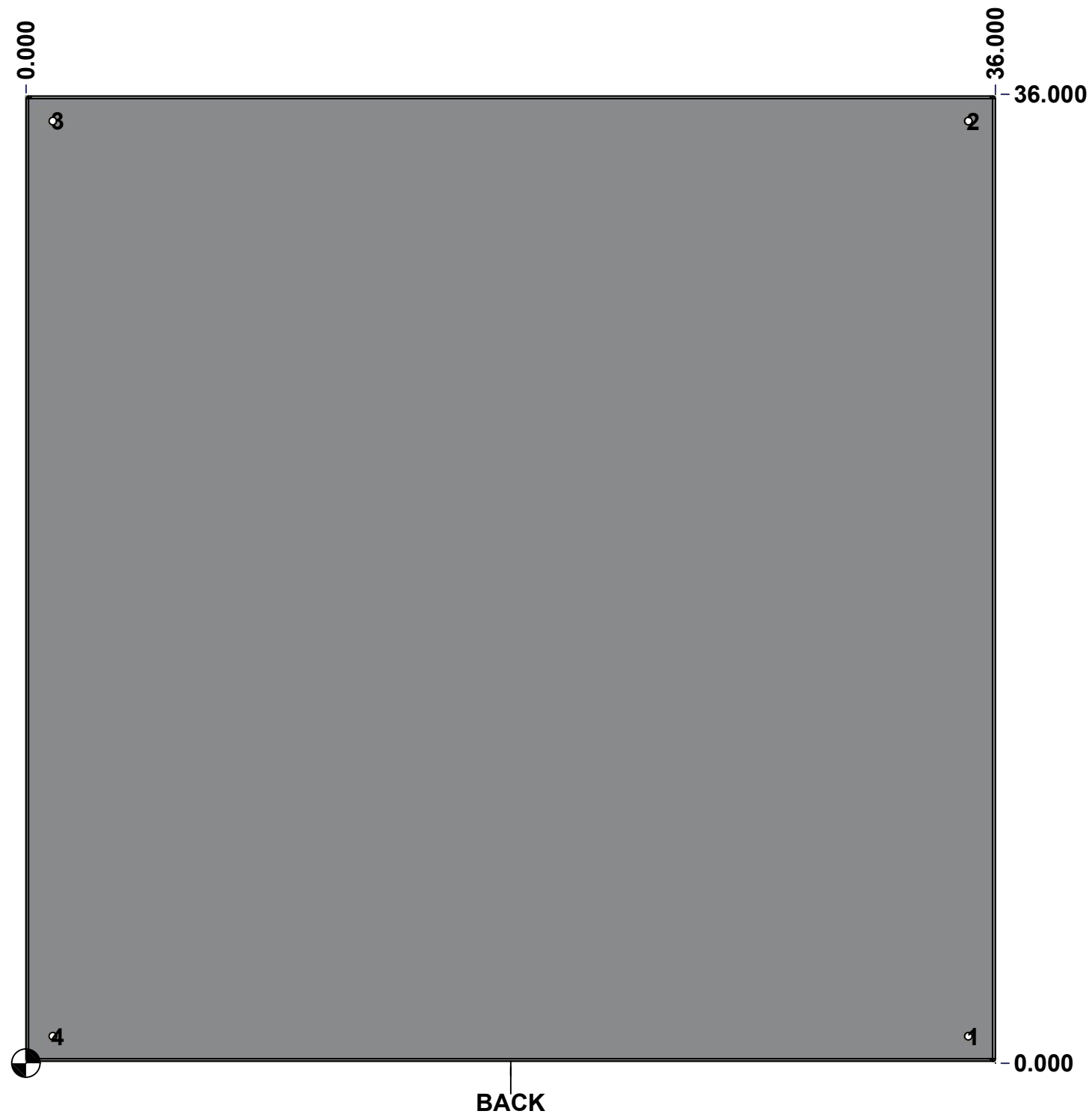

	Description	Status	
	1100DFPN 36" x 36" x 10" Body	(NULL)	
	Part Number Numéro Pièce	Rev.	
	1100DFP363610NB	0	6 / 10

This drawing is confidential and must not be reproduced or used without the consent of EXM

Ce dessin est confidentiel et ne doit pas être reproduit ou utilisé sans le consentement de EXM

No.	Revisions	Date	By/Par

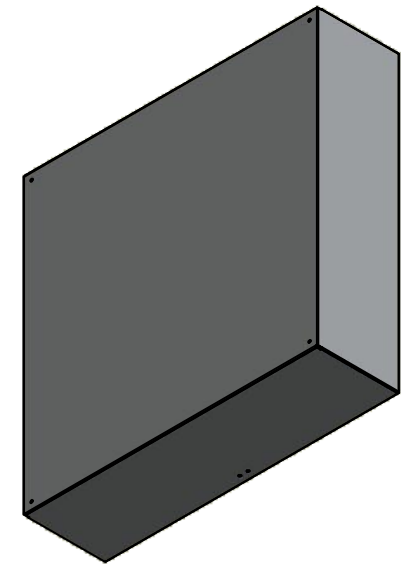

Isometric View

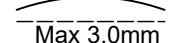
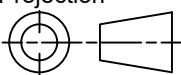

 Tél: (450) 979-4373 Fax: (450) 979-4626 www.exmweb.com		Flatness Aplatissement  Max 3.0mm Projection 
Customer Client	Date	
Drawn By Dessiné Par	BoxCad: BoxCad	Date 7/19/2022
Material Matière	14 Ga Cold Rolled A1008 CS Type B (1.7mm)	
Color Couleur	Asa-61 Grey	Finish Fini Smooth
Description		Detail Rev.
1100DFPN 36" x 36" x 10" Body		
Part Number Numéro Pièce	Rev.	7
1100DFP363610NB	0	10

Qty	Part Number	Rev	Description
1	STK-P-02400S	0	Powder Paint (Asa-61 Grey / Smooth)
1	1100DFP363610NT-P	0	1100DFPN 36" x 36" x 10" Body Part
1	1100DFP363610NBT-P	0	1100DFPN 36" x 36" x 10" Body Part
1	1100DFP363610NB-P	0	1100DFPN 36" x 36" x 10" Body Part
Parts List			

This drawing is confidential and must not be reproduced or used without the consent of EXM

Ce dessin est confidentiel et ne doit pas être reproduit ou utilisé sans le consentement de EXM

TOP

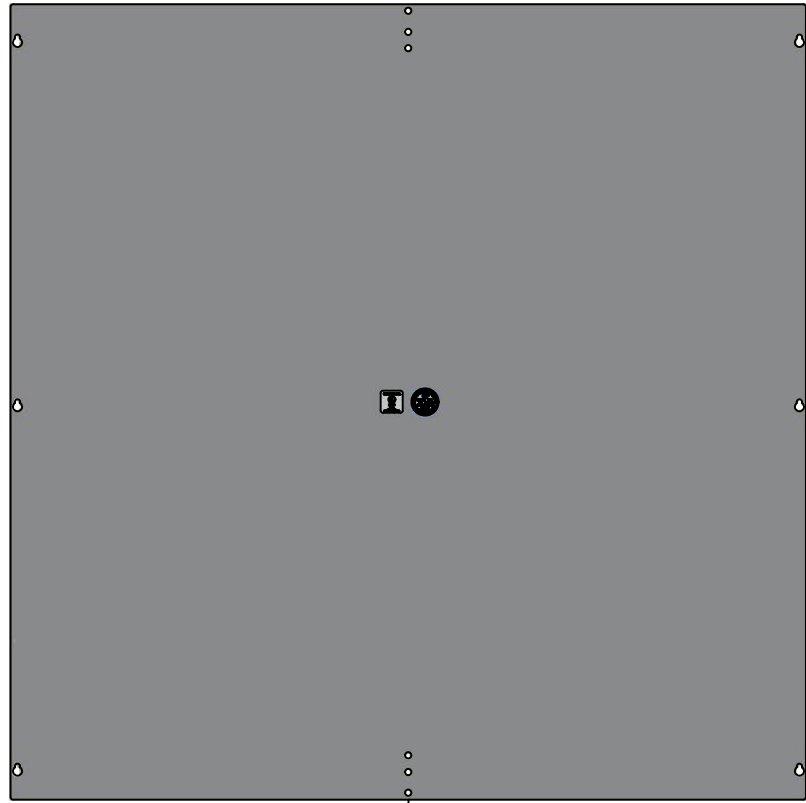

BACK

LEFT

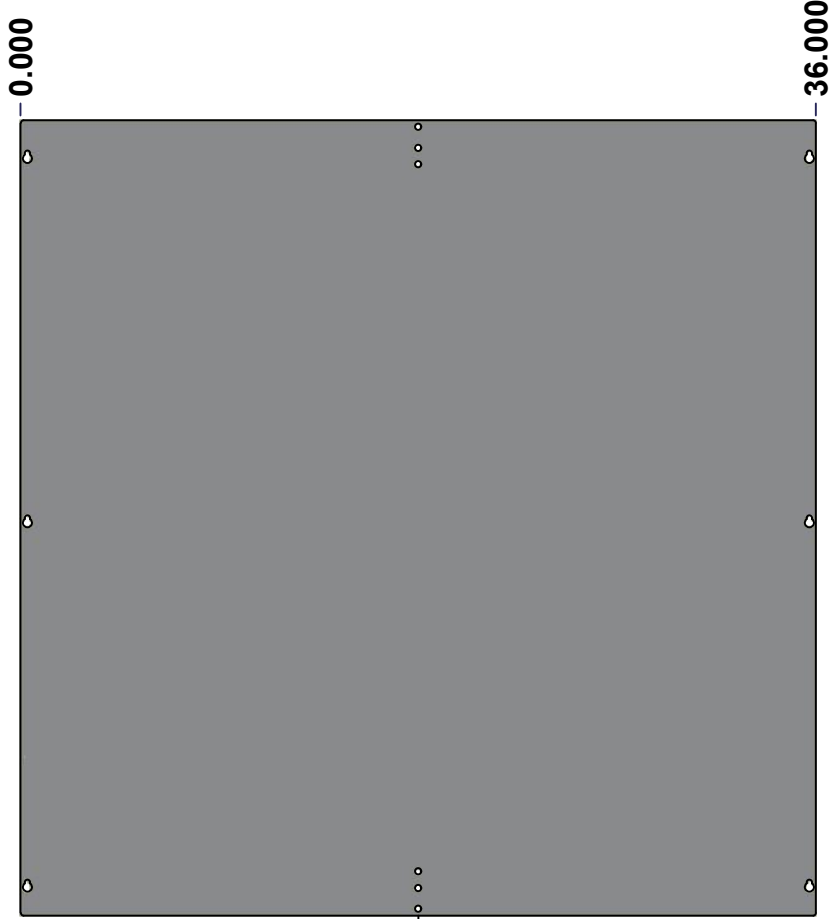

FRONT

RIGHT

No.	Revisions	Date	By/Par

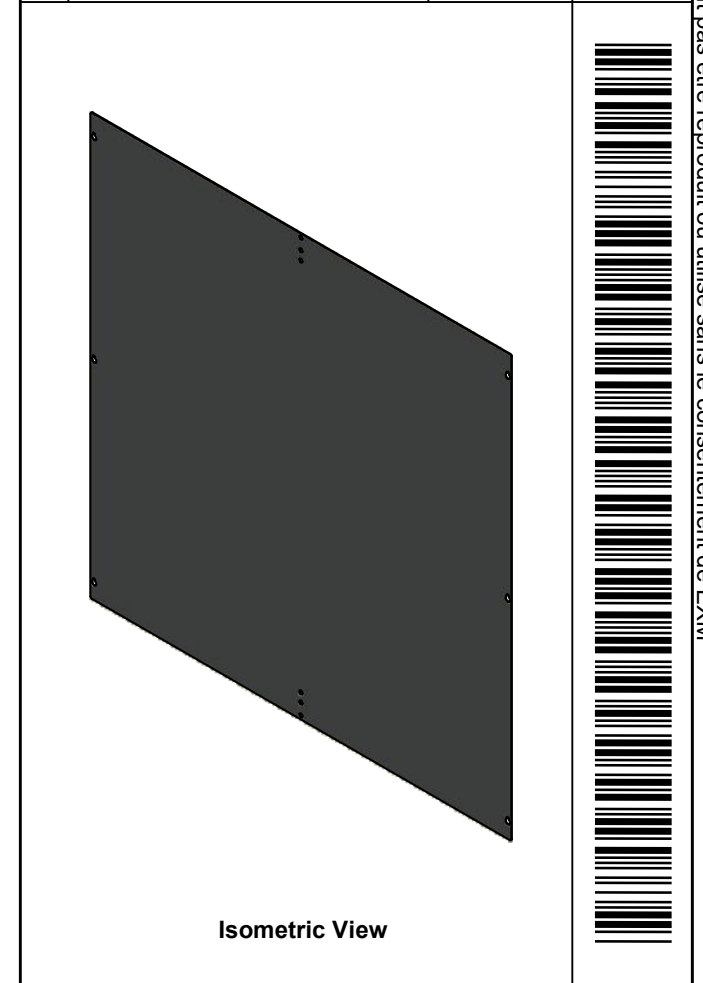

Isometric View

BOTTOM

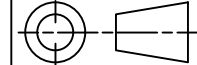
 Tél: (450) 979-4373 Fax: (450) 979-4626 www.exmweb.com	Flatness Aplatissement	Max 3.0mm
	Projection	
Customer Client	Date	
Drawn By Dessiné Par	BoxCad: BoxCad	Date 7/19/2022
Material Matière	16 Ga Cold Rolled A1008 CS Type B (1.4mm)	
Color Couleur	Asa-61 Grey	Finish Fini Smooth
Description	1100DFPN 36" x 36" Cover	
Part Number Numéro Pièce	Rev. 0	8 / 10

SEE BILL OF MATERIAL ON LAST PAGE

1100DFP363610NC

This drawing is confidential and must not be reproduced or used without the consent of EXM

Ce dessin est confidentiel et ne doit pas être reproduit ou utilisé sans le consentement de EXM

STANDARD FEATURES ARE NOT LISTED IN THIS HOLE TABLE			
HOLE TABLE - FRONT VIEW (CUSTOM FEATURE ONLY)			
CUT-OUT	XDIM	YDIM	DESCRIPTION
1	18.000	34.750	RND Ø0.290
2	18.000	34.000	RND Ø0.290
3	18.000	2.000	RND Ø0.290
4	18.000	1.250	RND Ø0.290

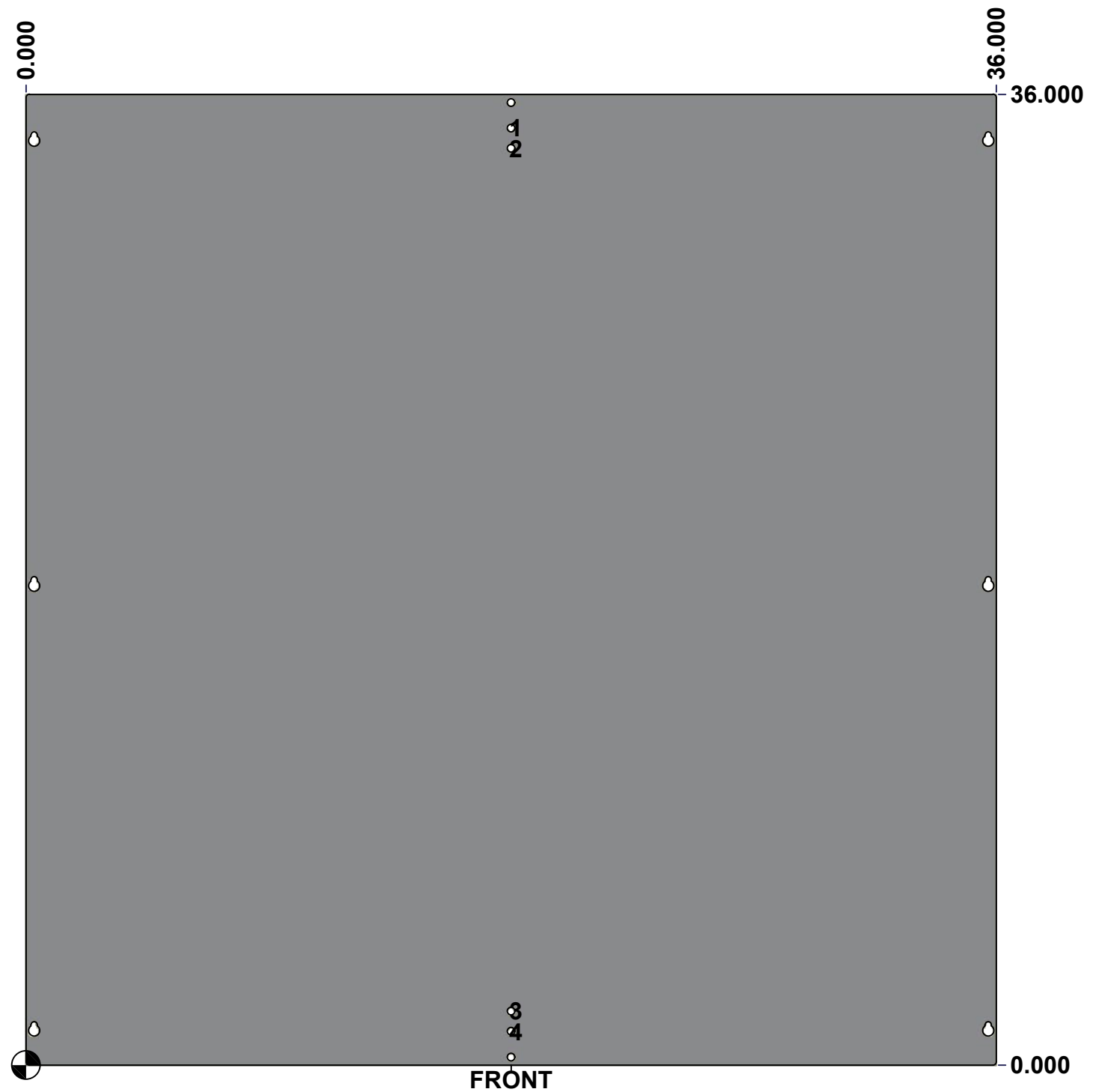

	Description	Status
	1100DFPN 36" x 36" Cover	(NULL)
	Part Number Numéro Pièce	Rev.
	1100DFP363610NC	0
		9 10

This drawing is confidential and must not be reproduced or used without the consent of EXM

Ce dessin est confidentiel et ne doit pas être reproduit ou utilisé sans le consentement de EXM

No.	Revisions	Date	By/Par

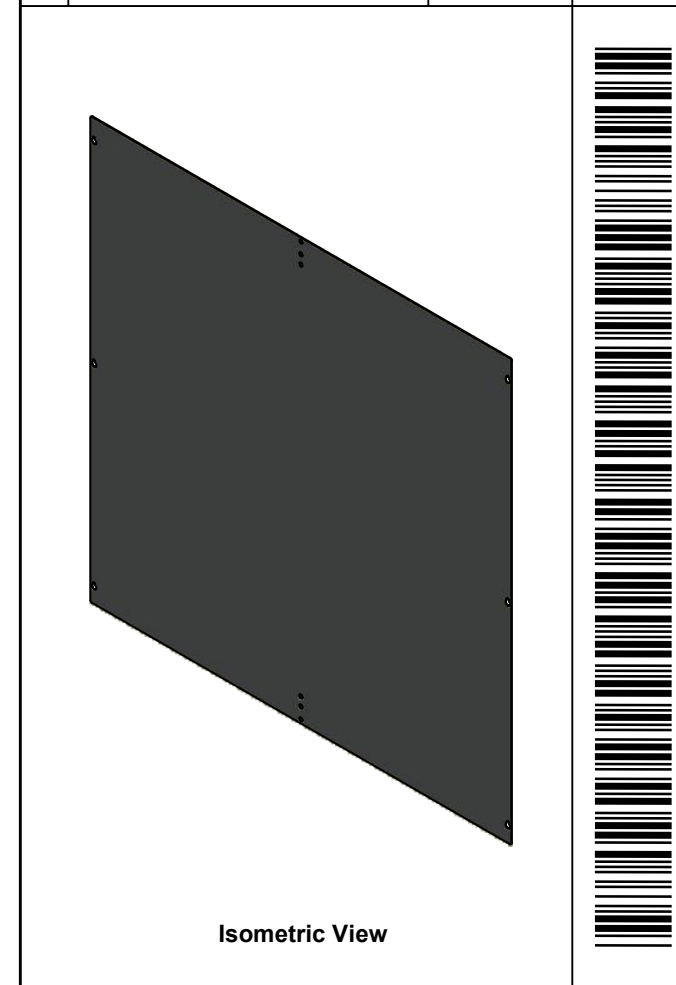

 Tél: (450) 979-4373 Fax: (450) 979-4626 www.exmweb.com	Flatness Aplatissement
	Max 3.0mm
	Projection
	

Customer Client	Date
Drawn By / Dessiné Par: BoxCad: BoxCad	Date: 7/19/2022
Material / Matière: 16 Ga Cold Rolled A1008 CS Type B (1.4mm)	

Color / Couleur: Asa-61 Grey	Finish / Fini: Smooth
------------------------------	-----------------------

Qty	Part Number	Rev	Description
1	STK-S-00950	1	UL 74SL Pull-Box Sticker
1	STK-S-00800	2	CSA Electrical Box Sticker
1	1100DFP363610NC-P	0	1100DFPN 36" x 36" Cover Part
1	STK-P-02400S	0	Powder Paint (Asa-61 Grey / Smooth)
Parts List			

Description: 1100DFPN 36" x 36" Cover	Detail Rev.
Part Number / Numéro Pièce: 1100DFP363610NC	Rev. 0
	10 / 10