

This drawing is confidential and must not be reproduced or used without the consent of EXM

Ce dessin est confidentiel et ne doit pas être reproduit ou utilisé sans le consentement de EXM

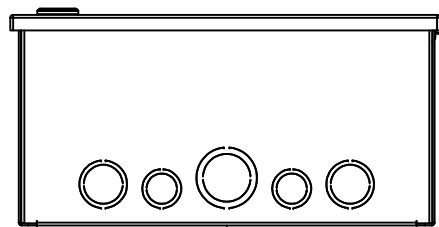

TOP

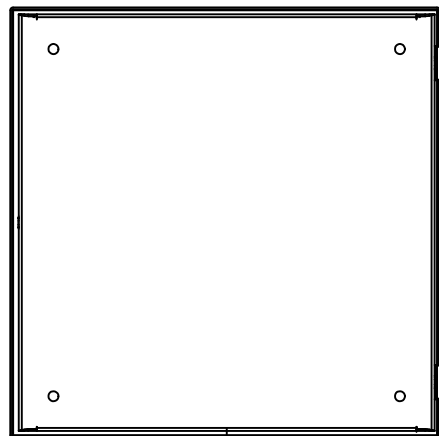

BACK

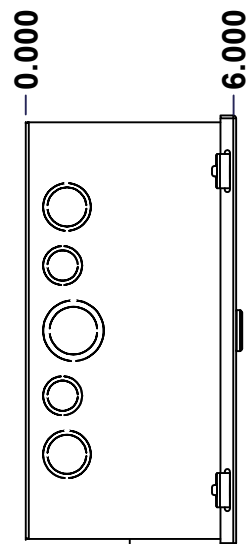

LEFT

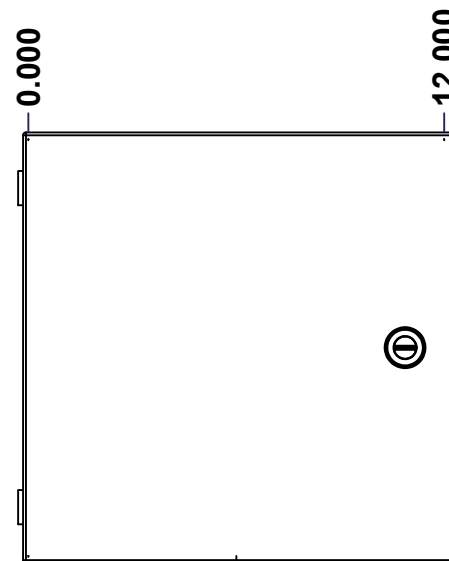

FRONT

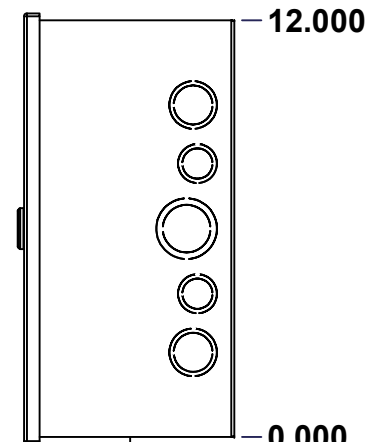

RIGHT

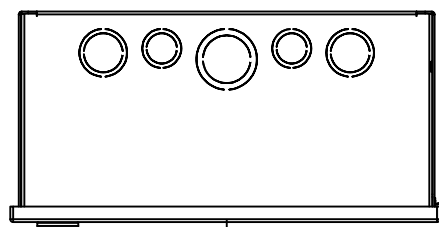

BOTTOM

No.	Revisions	Date	By/Par

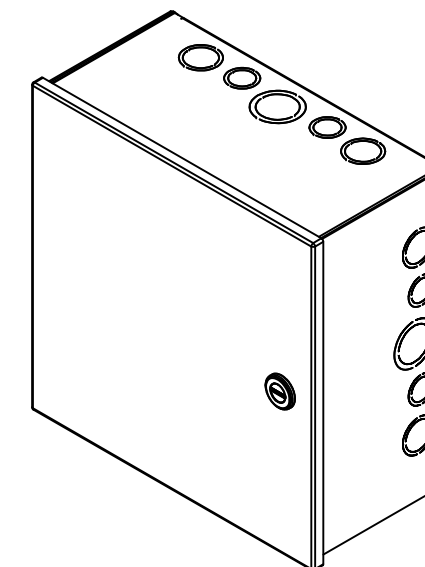

Isometric View



Tél: (450) 979-4373
 Fax: (450) 979-4626
www.exmweb.com

Flatness Aplatissement	Max 3.0mm
Projection	

Customer Client	Date
Drawn By Dessiné Par	Date 21-Jan-14
Material Matière	16 Ga H.R.P. & O. (1.4mm)

Color Couleur	Asa-61 Grey	Finish Fini	Smooth
------------------	-------------	----------------	--------

Description	Detail Rev.
1100E 12" x 12" x 6" Assembly	

Part Number Numéro Pièce	Rev.	1
1100E121206	0	2

SEE BILL OF MATERIAL ON LAST PAGE

This drawing is confidential and must not be reproduced or used without the consent of EXM

Ce dessin est confidentiel et ne doit pas être reproduit ou utilisé sans le consentement de EXM

NOTE	
ITEM	DESCRIPTION
1	NEMA 1 Enclosure
2	C/W Standard ground provision on box and cover
3	W/O Standard door stiffener
4	W/O Inner panel
5	W/O Inner panel mounting provision

No.	Revisions	Date	By/Par

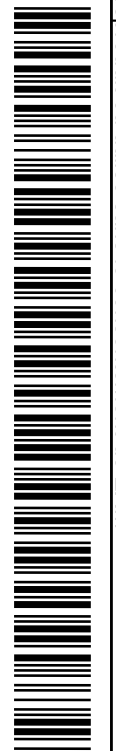
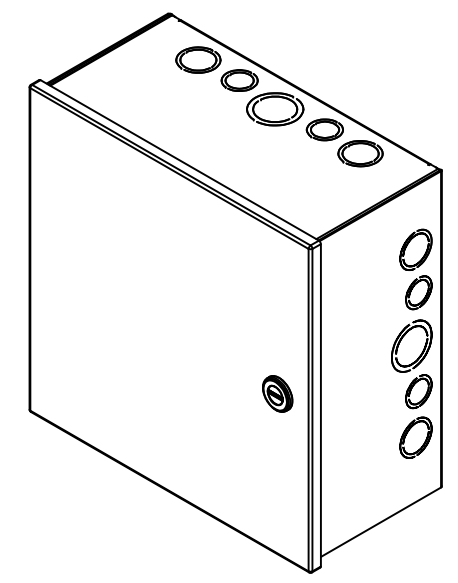

Isometric View



Tél: (450) 979-4373
 Fax: (450) 979-4626
www.exmweb.com

Flatness
Aplatissement
Max 3.0mm
Projection

Customer Client	Date
Drawn By / Dessiné Par: BoxCad: BoxCad	Date: 21-Jan-14
Material / Matière: 16 Ga H.R.P. & O. (1.4mm)	
Color / Couleur: Asa-61 Grey	Finish / Fini: Smooth

PACKING		
ITEM	QTY	DESCRIPTION
Thermal plastic film	1	Use with Packing Tunnel Wrapper Machine
Packaging label	1	White label with product number

1	1100E121206C	0	1100E 12" x 12" Cover
1	1100E121206B	0	1100E 12" x 12" x 6" Body
Qty	Part Number	Rev	Description
Parts List			

Description: 1100E 12" x 12" x 6" Assembly	Detail Rev.
Part Number / Numéro Pièce: 1100E121206	Rev. 0
	2 / 2

This drawing is confidential and must not be reproduced or used without the consent of EXM

Ce dessin est confidentiel et ne doit pas être reproduit ou utilisé sans le consentement de EXM

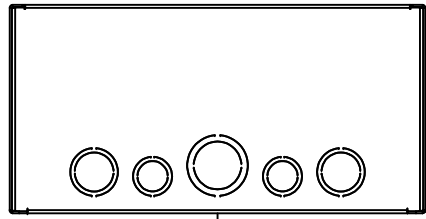

TOP

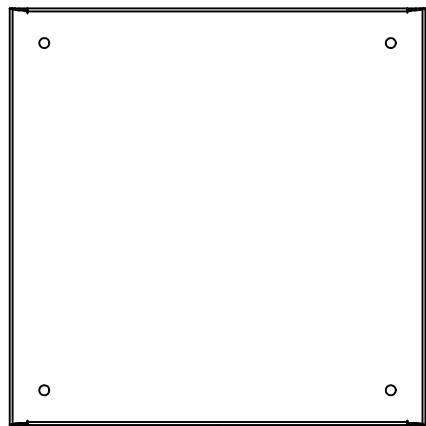

BACK

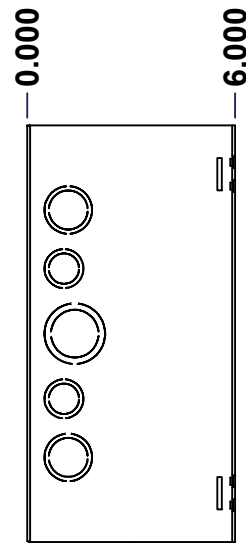

LEFT

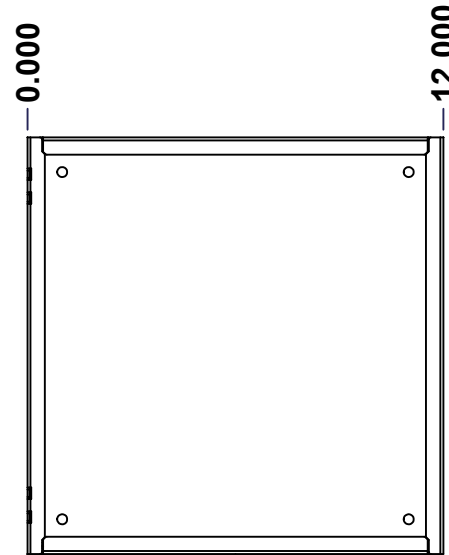

FRONT

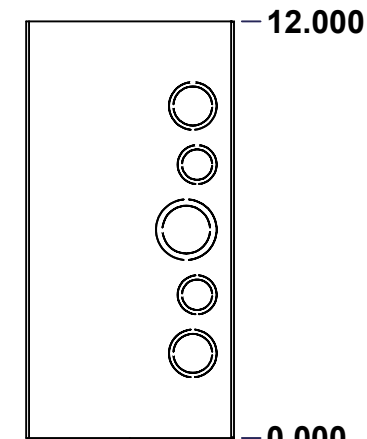

RIGHT

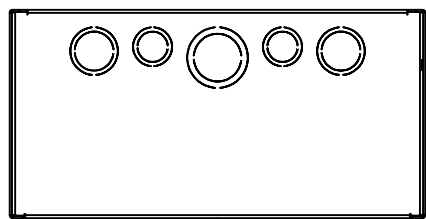

BOTTOM

No.	Revisions	Date	By/Par

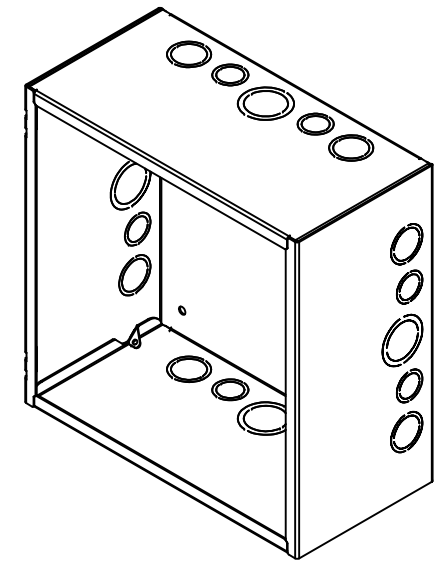

Isometric View



Tél: (450) 979-4373
 Fax: (450) 979-4626
www.exmweb.com

Flatness
Aplatissement

Max 3.0mm

Projection

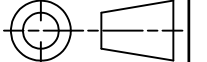

Customer Client	Date
Drawn By / Dessiné Par: BoxCad: BoxCad	Date: 21-Jan-14
Material / Matière: 16 Ga H.R.P. & O. (1.4mm)	
Color / Couleur: Asa-61 Grey	Finish / Fini: Smooth
Description: 1100E 12" x 12" x 6" Body	Detail Rev.
Part Number / Numéro Pièce: 1100E121206B	Rev. 0

SEE BILL OF MATERIAL ON LAST PAGE

1
7

This drawing is confidential and must not be reproduced or used without the consent of EXM

Ce dessin est confidentiel et ne doit pas être reproduit ou utilisé sans le consentement de EXM

STANDARD FEATURES ARE NOT LISTED IN THIS HOLE TABLE

HOLE TABLE - TOP VIEW (CUSTOM FEATURE ONLY)

CUT-OUT	XDIM	YDIM	DESCRIPTION
1	9.563	1.188	DKO Ø1.375 - 1.125
2	7.875	1.063	DKO Ø1.125 - 0.875
3	6.000	1.375	DKO Ø1.750 - 1.375
4	4.125	1.063	DKO Ø1.125 - 0.875
5	2.437	1.188	DKO Ø1.375 - 1.125

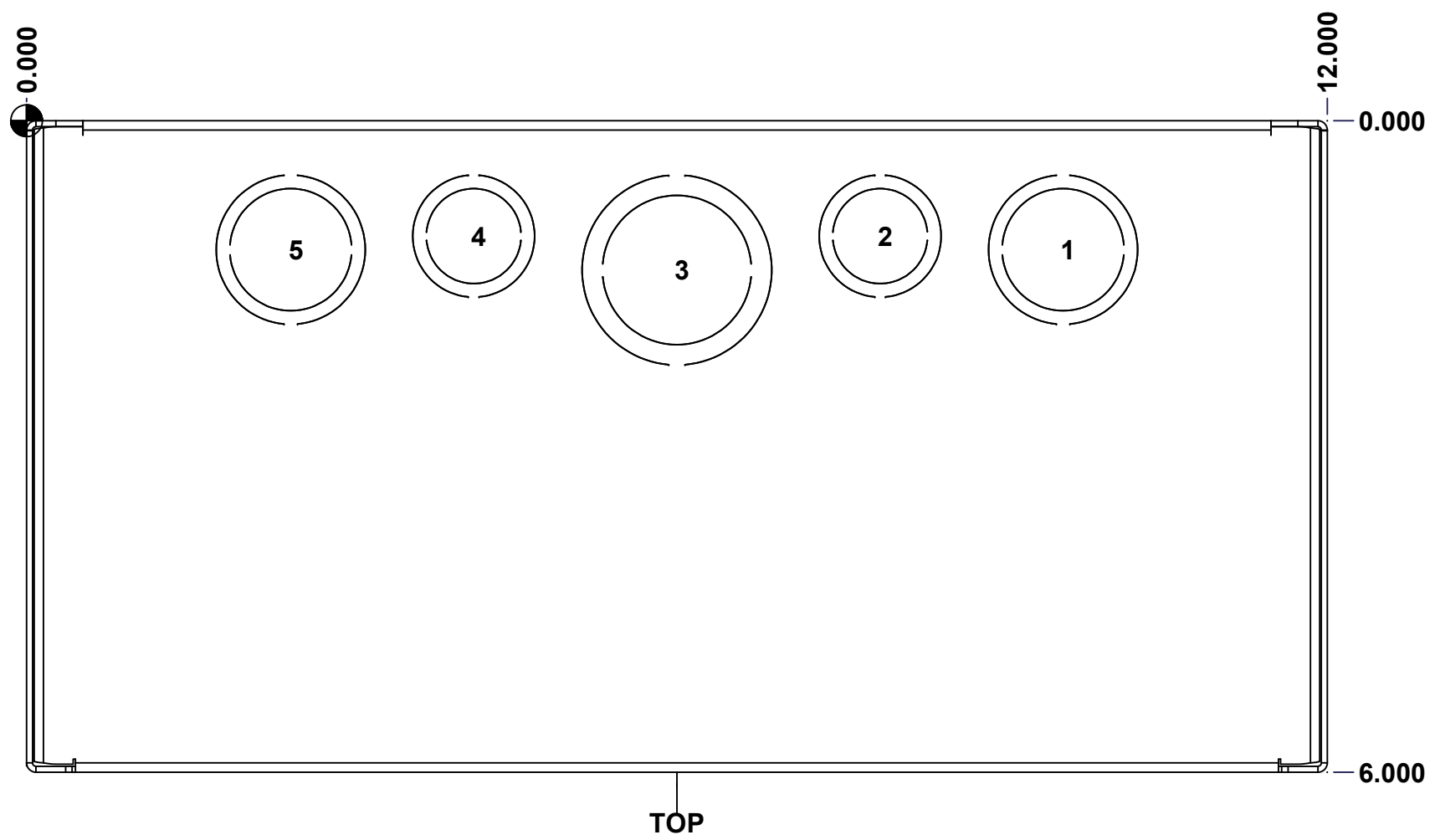

	Description	Status	
	1100E 12" x 12" x 6" Body	(NULL)	
	Part Number Numéro Pièce	Rev.	
	1100E121206B	0	2 / 7

This drawing is confidential and must not be reproduced or used without the consent of EXM

Ce dessin est confidentiel et ne doit pas être reproduit ou utilisé sans le consentement de EXM

STANDARD FEATURES ARE NOT LISTED IN THIS HOLE TABLE

HOLE TABLE - RIGHT VIEW (CUSTOM FEATURE ONLY)

CUT-OUT	XDIM	YDIM	DESCRIPTION
1	1.188	9.563	DKO Ø1.375 - 1.125
2	1.063	7.875	DKO Ø1.125 - 0.875
3	1.375	6.000	DKO Ø1.750 - 1.375
4	1.063	4.125	DKO Ø1.125 - 0.875
5	1.188	2.437	DKO Ø1.375 - 1.125

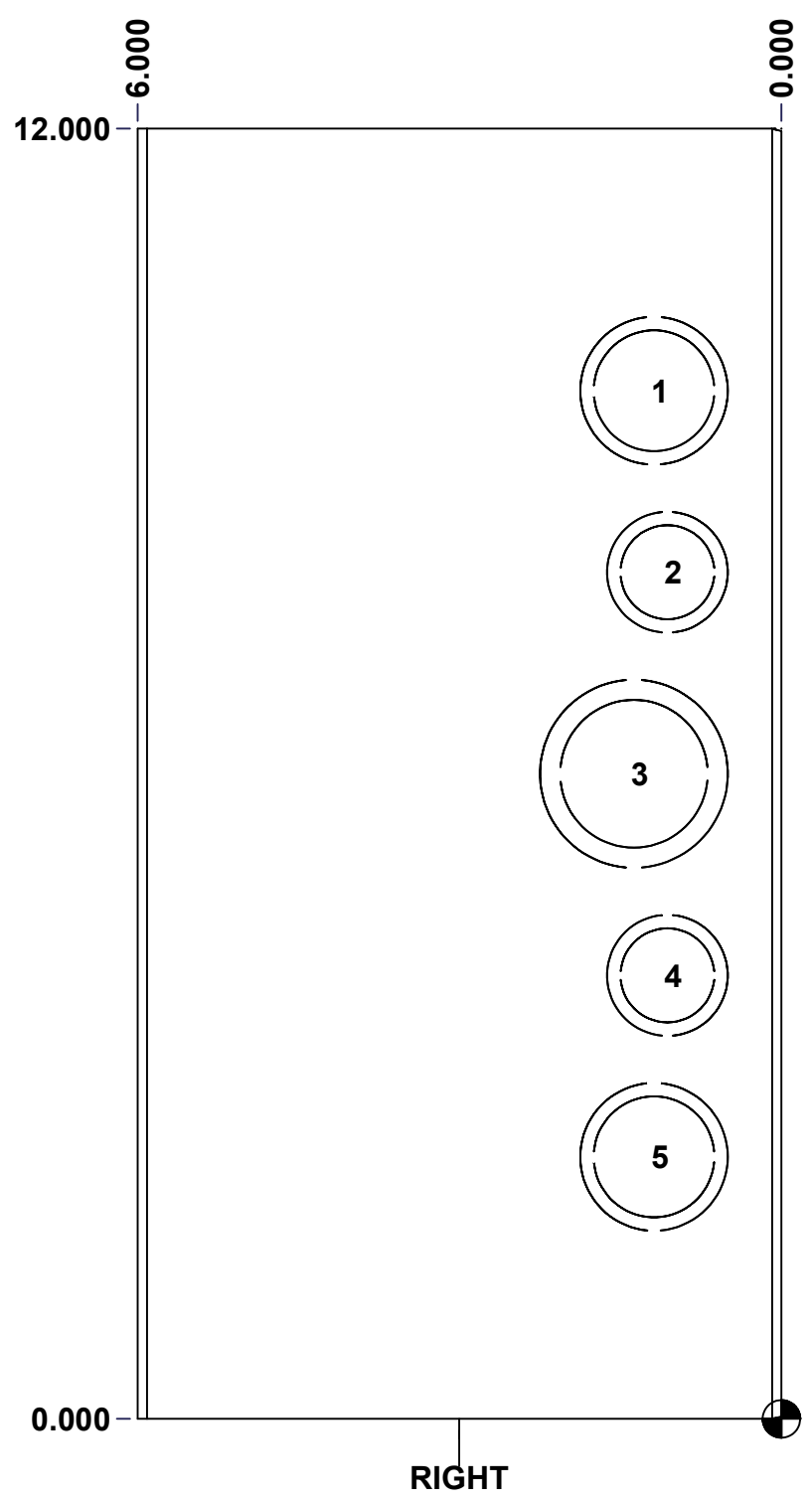

	Description	Status	
	1100E 12" x 12" x 6" Body	(NULL)	
	Part Number Numéro Pièce	Rev.	
	1100E121206B	0	3 / 7

This drawing is confidential and must not be reproduced or used without the consent of EXM

Ce dessin est confidentiel et ne doit pas être reproduit ou utilisé sans le consentement de EXM

STANDARD FEATURES ARE NOT LISTED IN THIS HOLE TABLE

HOLE TABLE - BOTTOM VIEW (CUSTOM FEATURE ONLY)

CUT-OUT	XDIM	YDIM	DESCRIPTION
1	9.563	1.188	DKO Ø1.375 - 1.125
2	7.875	1.063	DKO Ø1.125 - 0.875
3	6.000	1.375	DKO Ø1.750 - 1.375
4	4.125	1.063	DKO Ø1.125 - 0.875
5	2.437	1.188	DKO Ø1.375 - 1.125

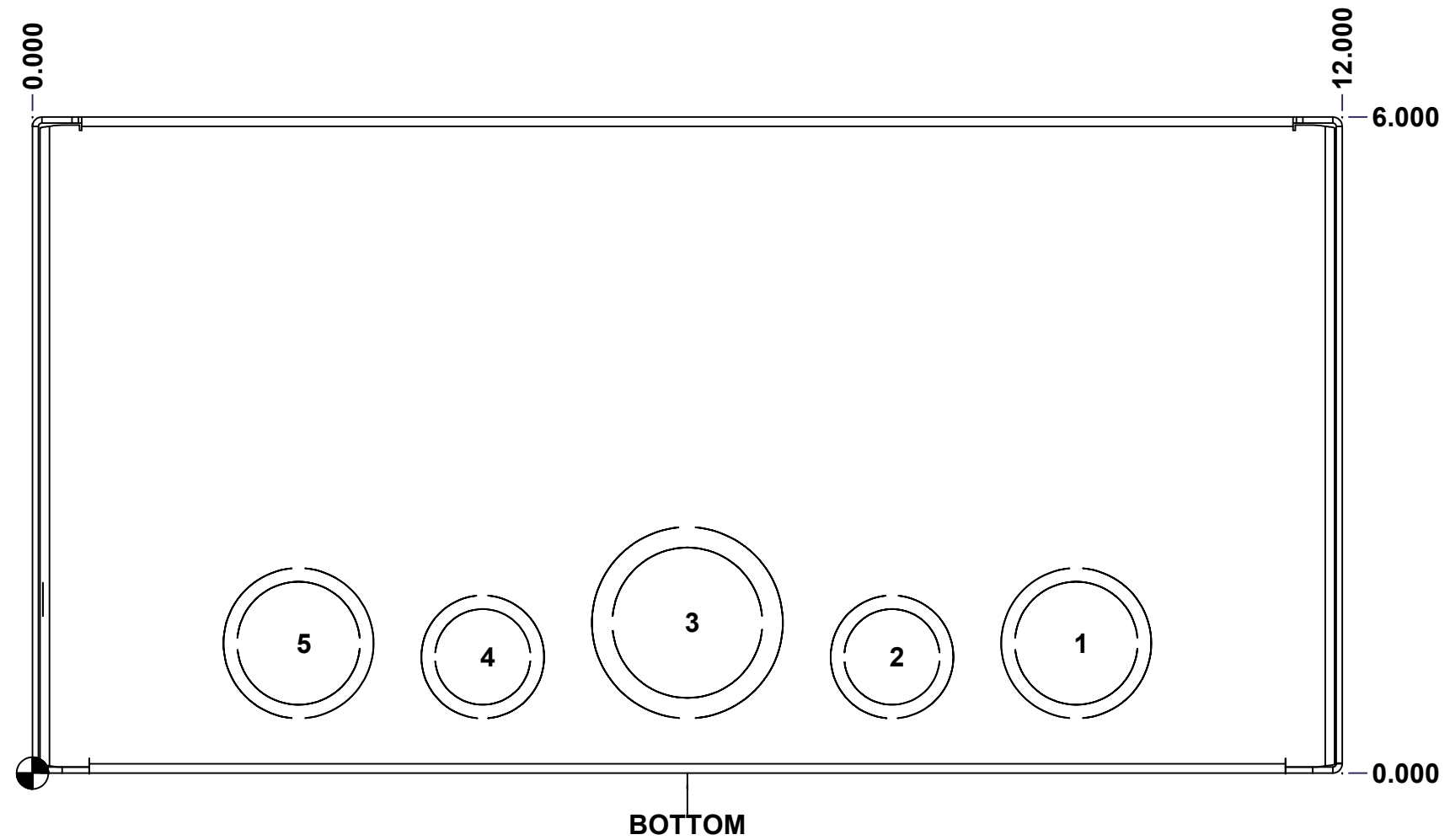

	Description	Status
	1100E 12" x 12" x 6" Body	(NULL)
	Part Number Numéro Pièce	Rev.
	1100E121206B	0
		4 / 7

This drawing is confidential and must not be reproduced or used without the consent of EXM

Ce dessin est confidentiel et ne doit pas être reproduit ou utilisé sans le consentement de EXM

STANDARD FEATURES ARE NOT LISTED IN THIS HOLE TABLE

HOLE TABLE - LEFT VIEW (CUSTOM FEATURE ONLY)

CUT-OUT	XDIM	YDIM	DESCRIPTION
1	1.188	9.563	DKO Ø1.375 - 1.125
2	1.063	7.875	DKO Ø1.125 - 0.875
3	1.375	6.000	DKO Ø1.750 - 1.375
4	1.063	4.125	DKO Ø1.125 - 0.875
5	1.188	2.437	DKO Ø1.375 - 1.125

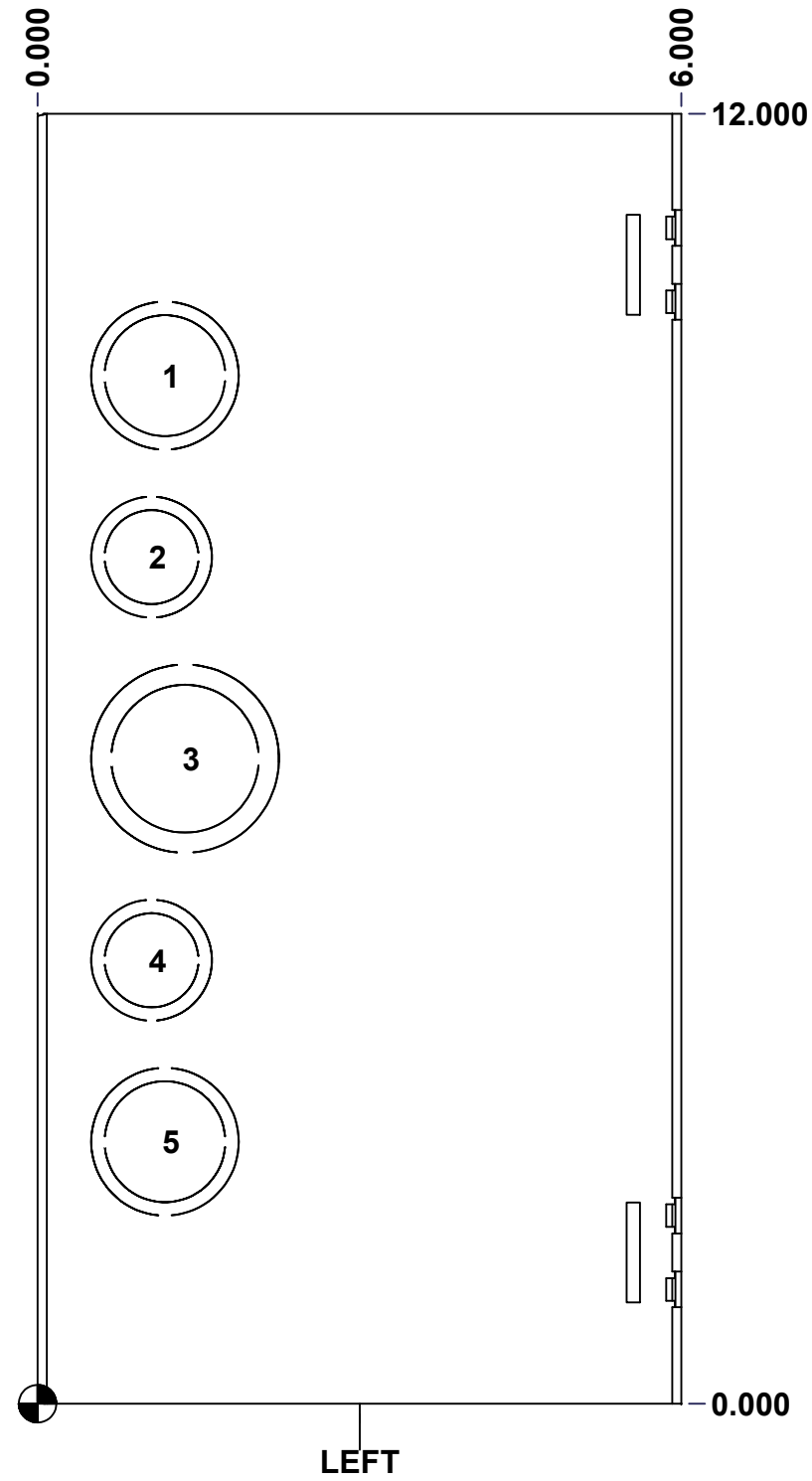

	Description	Status
	1100E 12" x 12" x 6" Body	(NULL)
	Part Number Numéro Pièce	Rev.
	1100E121206B	0
		5
		7

This drawing is confidential and must not be reproduced or used without the consent of EXM

Ce dessin est confidentiel et ne doit pas être reproduit ou utilisé sans le consentement de EXM

STANDARD FEATURES ARE NOT LISTED IN THIS HOLE TABLE			
HOLE TABLE - BACK VIEW (CUSTOM FEATURE ONLY)			
CUT-OUT	XDIM	YDIM	DESCRIPTION
1	11.000	1.000	RND Ø0.290
2	11.000	11.000	RND Ø0.290
3	1.000	11.000	RND Ø0.290
4	1.000	1.000	RND Ø0.290

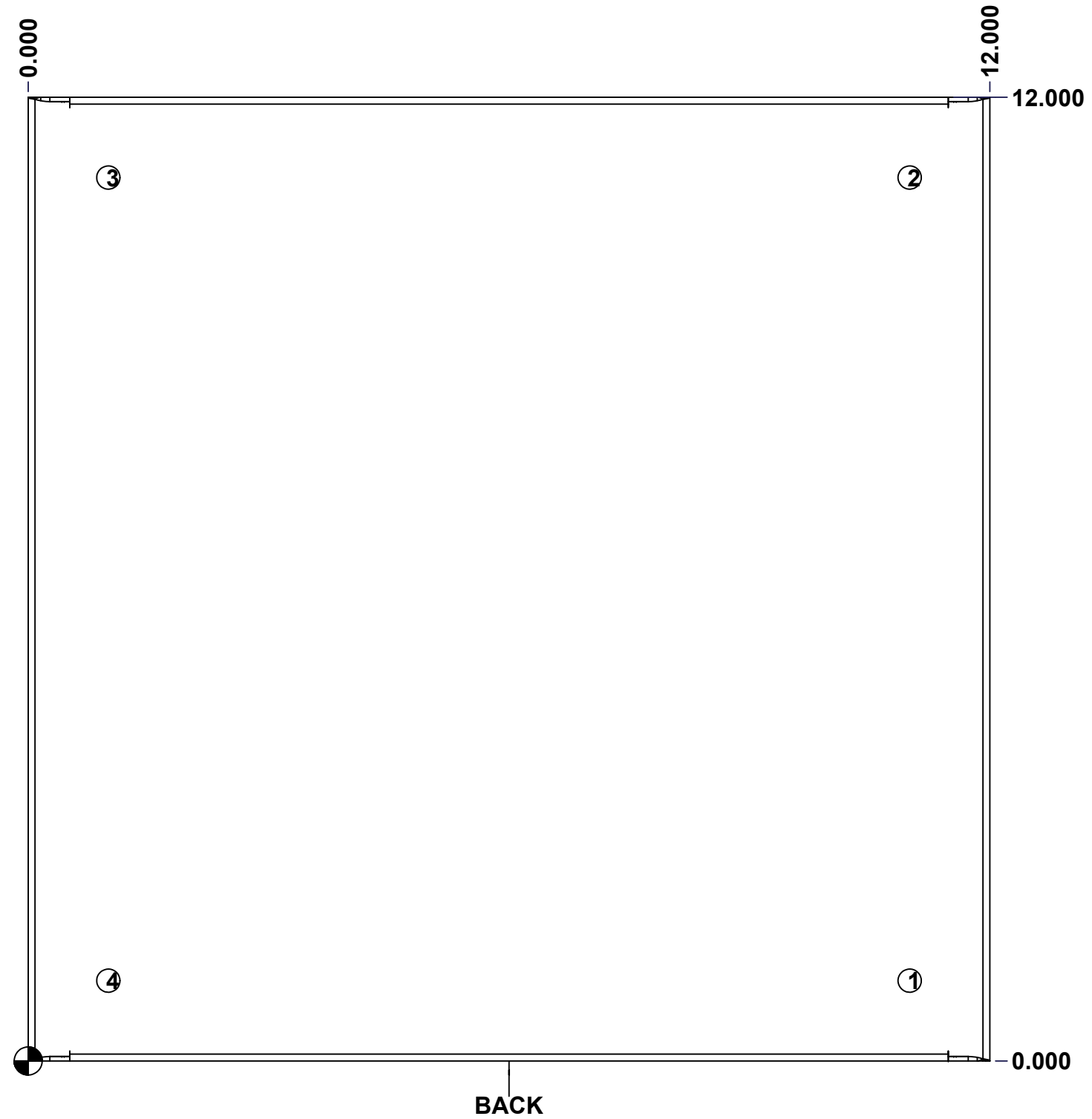

	Description	Status	
	1100E 12" x 12" x 6" Body	(NULL)	
	Part Number Numéro Pièce	Rev.	
	1100E121206B	0	6 / 7

This drawing is confidential and must not be reproduced or used without the consent of EXM

Ce dessin est confidentiel et ne doit pas être reproduit ou utilisé sans le consentement de EXM

No.	Revisions	Date	By/Par

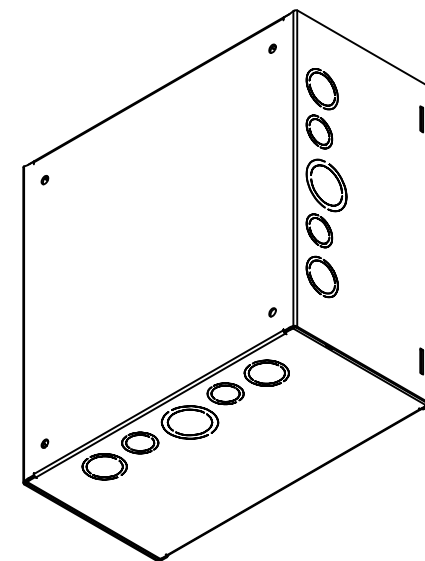

Isometric View



Tél: (450) 979-4373
 Fax: (450) 979-4626
www.exmweb.com

Flatness
Aplatissement
Max 3.0mm
Projection

Customer Client	Date
Drawn By / Dessiné Par: BoxCad: BoxCad	Date: 21-Jan-14
Material / Matière: 16 Ga H.R.P. & O. (1.4mm)	
Color / Couleur: Asa-61 Grey	Finish / Fini: Smooth

Qty	Part Number	Rev	Description
1	STK-P-02400S	0	Powder Paint (Asa-61 Grey / Smooth)
1	1100E121206B-P	0	1100E 12" x 12" x 6" Body Part
Parts List			

Description: 1100E 12" x 12" x 6" Body	Detail Rev.
Part Number / Numéro Pièce: 1100E121206B	Rev. 0 / 7

This drawing is confidential and must not be reproduced or used without the consent of EXM

Ce dessin est confidentiel et ne doit pas être reproduit ou utilisé sans le consentement de EXM

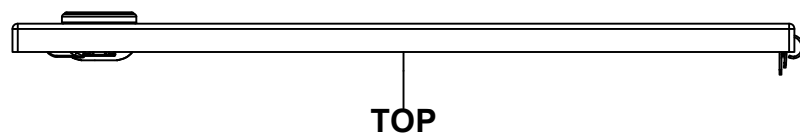

TOP

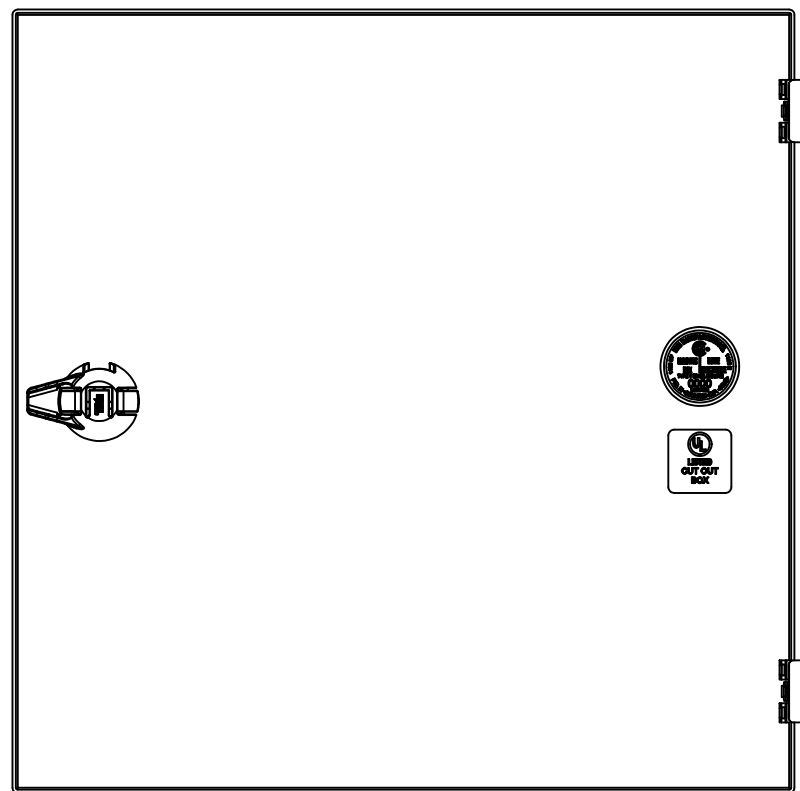

BACK

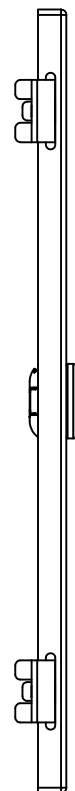

LEFT

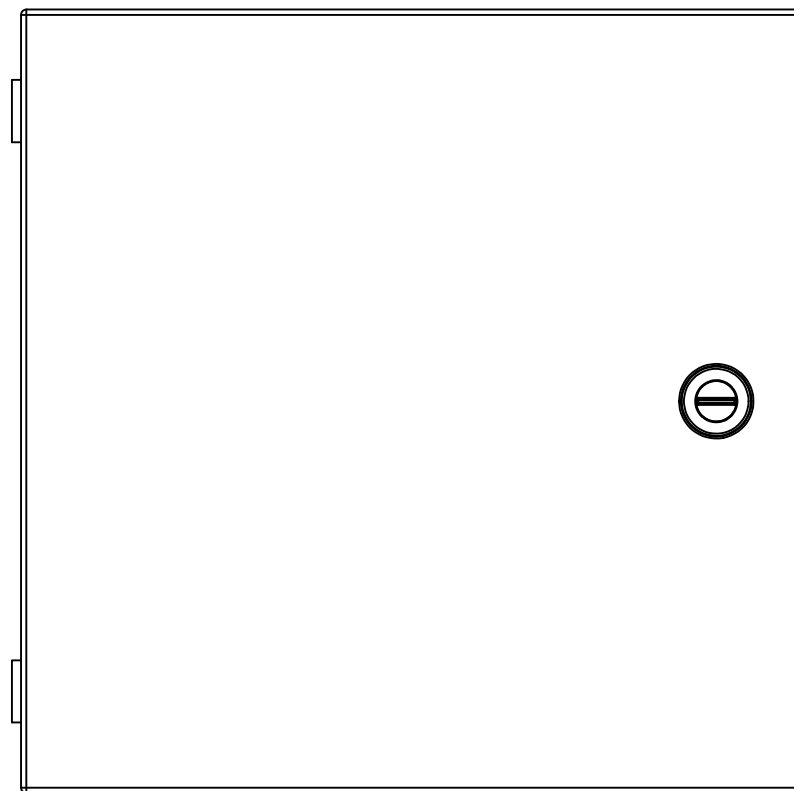

FRONT



RIGHT

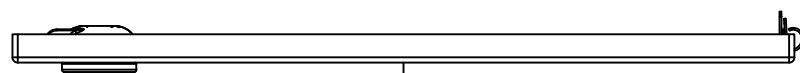

BOTTOM

No.	Revisions	Date	By/Par

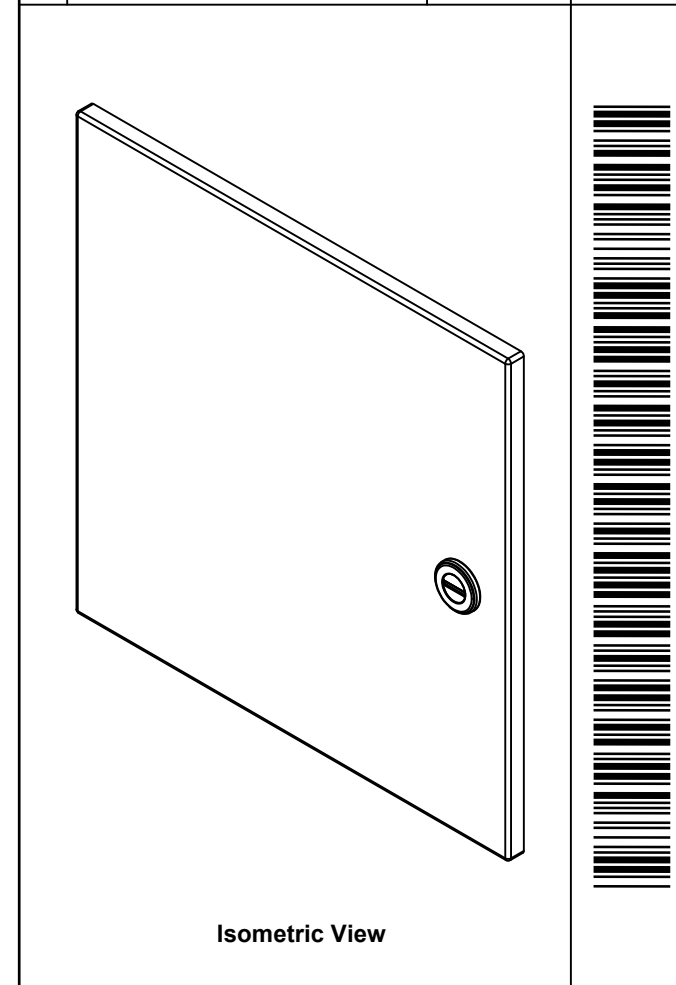

Isometric View

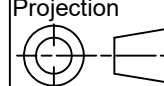

 Tél: (450) 979-4373 Fax: (450) 979-4626 www.exmweb.com		Flatness Aplatissement Max 3.0mm Projection 
Customer Client	Date	
Drawn By Dessiné Par	BoxCad: BoxCad	Date 21-Jan-14
Material Matière	16 Ga H.R.P. & O. (1.4mm)	
Color Couleur	Asa-61 Grey	Finish Fini Smooth
Description	Detail Rev.	
1100E 12" x 12" Cover		
Part Number Numéro Pièce	Rev. 0	1 / 3
1100E121206C		

SEE BILL OF MATERIAL ON LAST PAGE

This drawing is confidential and must not be reproduced or used without the consent of EXM

Ce dessin est confidentiel et ne doit pas être reproduit ou utilisé sans le consentement de EXM

STANDARD FEATURES ARE NOT LISTED IN THIS HOLE TABLE			
HOLE TABLE - FRONT VIEW (CUSTOM FEATURE ONLY)			
CUT-OUT	XDIM	YDIM	DESCRIPTION
1	11.025	6.200	LOCK 880 SCQ1-SL @ 0.0°

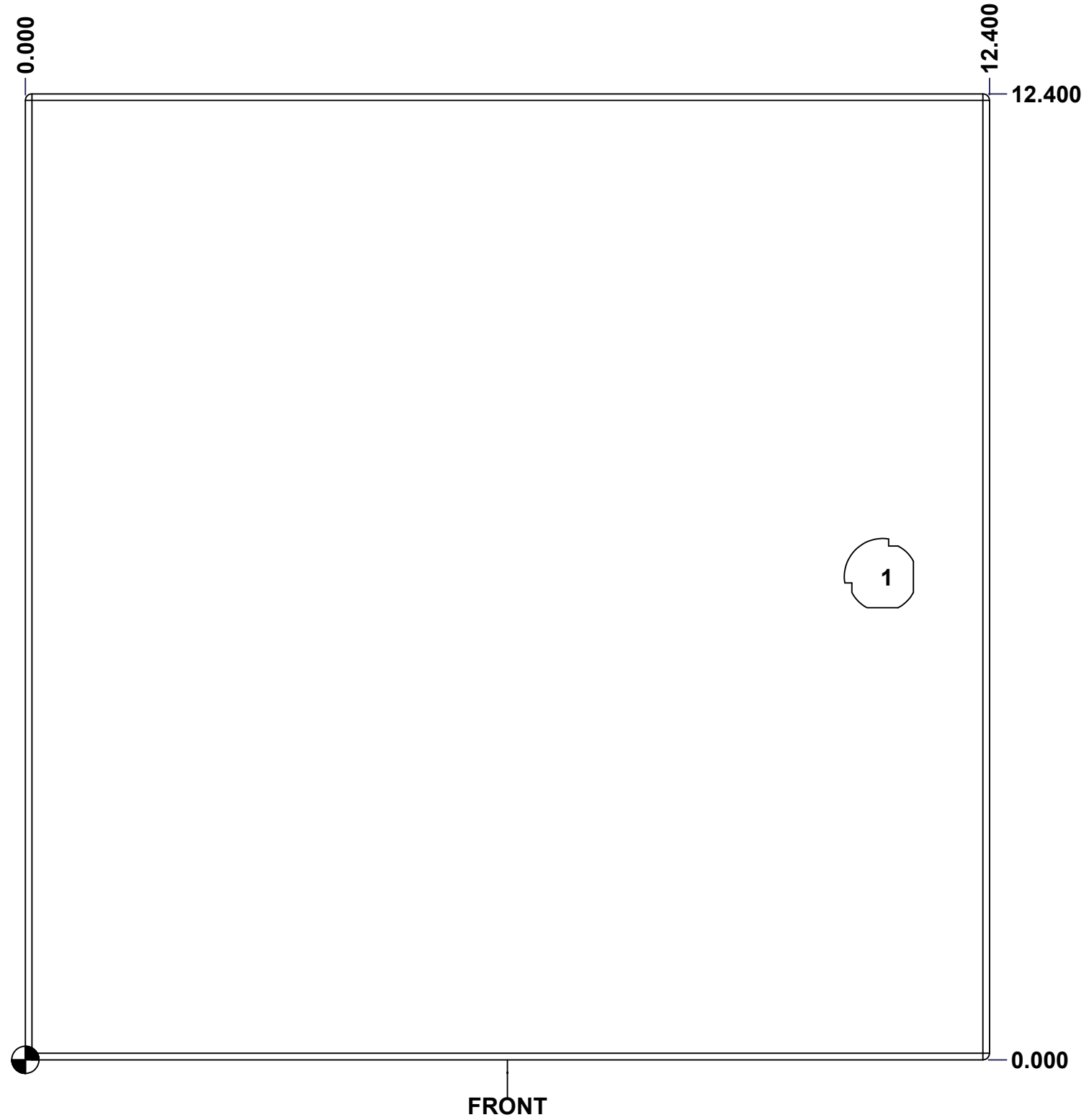

	Description	Status	
	1100E 12" x 12" x 6" Cover	(NULL)	
	Part Number Numéro Pièce	Rev.	
	1100E121206C	0	2 3

This drawing is confidential and must not be reproduced or used without the consent of EXM

Ce dessin est confidentiel et ne doit pas être reproduit ou utilisé sans le consentement de EXM

No.	Revisions	Date	By/Par

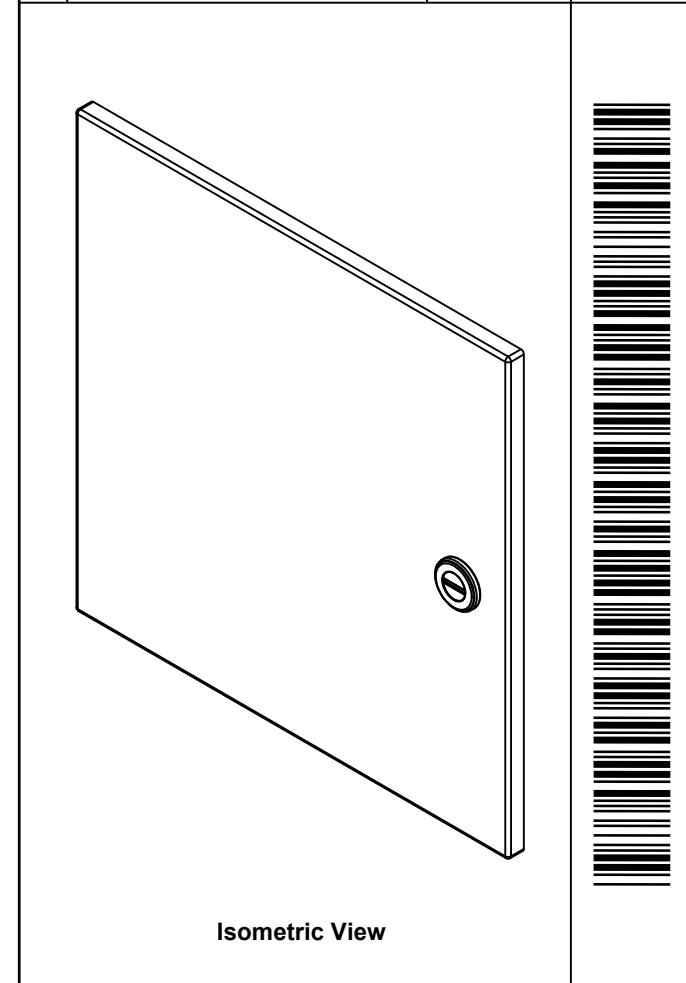

Tél: (450) 979-4373 Fax: (450) 979-4626 www.exmweb.com		Flatness Aplatissement	
		Max 3.0mm Projection	
Customer Client		Date	
Drawn By Dessiné Par		Date	
BoxCad: BoxCad		21-Jan-14	
Material Matière			
16 Ga H.R.P. & O. (1.4mm)			
Color Couleur		Finish Fini	
Asa-61 Grey		Smooth	
Description			Detail Rev.
1100E 12" x 12" Cover			
Part Number Numéro Pièce		Rev.	3
1100E121206C		0	3

Qty	Part Number	Rev	Description
1	880 SCQ1-SL	0	1100 1/4 Turn Lock
1	STK-S-00900	0	UL Cut-Out Box Sticker
1	STK-S-00800	2	CSA Electrical Box Sticker
2	STK-Q-33361	0	Spring Steel Hinge
1	1100E121206C-P	0	1100E 12" x 12" x 6" Cover Part
1	STK-P-02400S	0	Powder Paint (Asa-61 Grey / Smooth)
Parts List			