

All knockouts are actual size / Les disques défonçables sont grandeur réel
 All dimensions are before paint / Toutes les dimensions sont avant peinture

This drawing is confidential and must not be reproduced or used without the consent of EXM

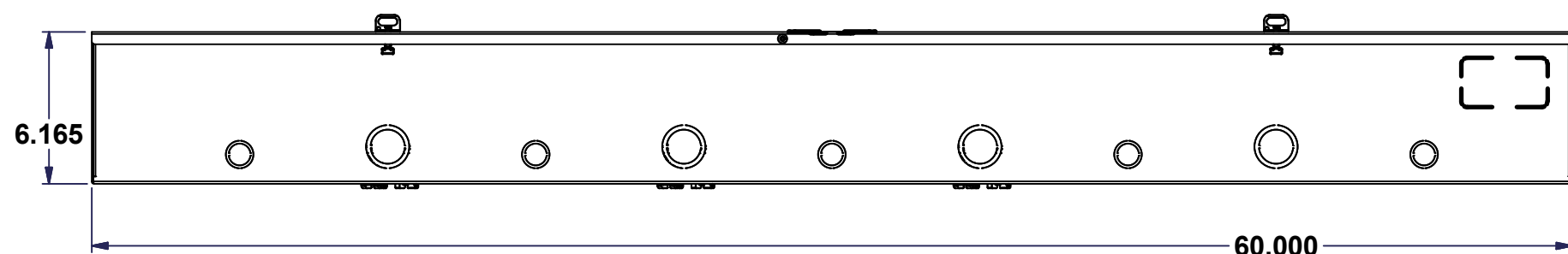

No.	Revisions	Date	By/Par
1	Redraw Model	11/08/2008	MichelP
2	Change Qty. tab on 400 & 600 AMP	08/12/2008	MichelP
3	Change for new hinge & change K-O size on 200 AMP	19/10/2009	MichelP
4	Turn into iLogic	20/4/2010	MichelP
5	Change sticker position and ground shape from 1.250 to 0.500	30/08/2010	AllenL

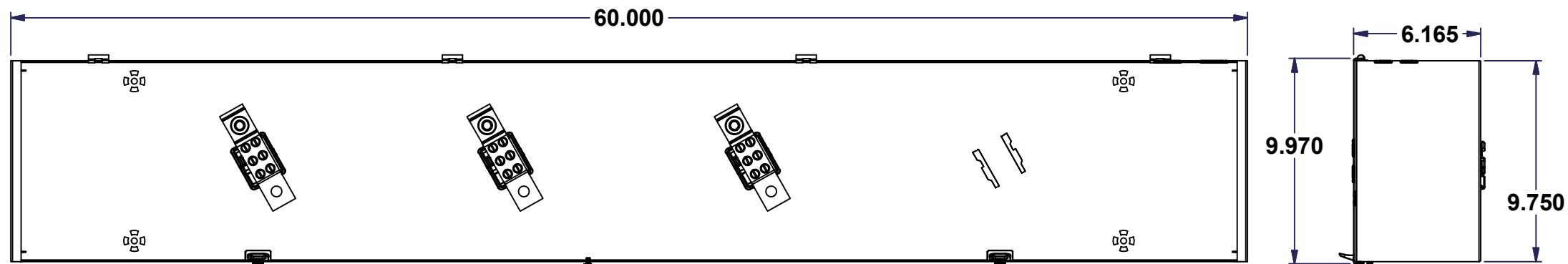
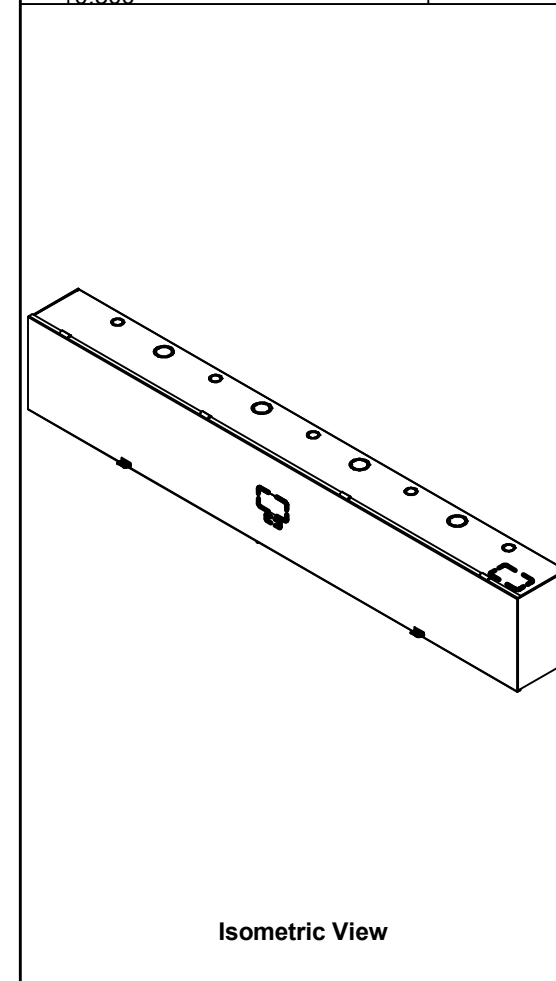

Ce dessin est confidentiel et ne doit pas être reproduit ou utilisé sans le consentement de EXM

 Tél: (450) 979-4373 Fax: (450) 979-4626 www.exmweb.com		Flatness Aplatissement
		Max 3.0mm
Customer Client		Date
Drawn By Dessiné Par MichaelA		Date 10-Feb-15
Material Matière See Part List		
Color Couleur See Part List	Finish Fini See Part List	
Description 1100 T5403 Assembly		Detail Rev.
Part Number Numéro Pièce 1100T5403	Rev. 5	1 3

All knockouts are actual size / Les disques défonçables sont grandeur réel
 All dimensions are before paint / Toutes les dimensions sont avant peinture

This drawing is confidential and must not be reproduced or used without the consent of EXM

Ce dessin est confidentiel et ne doit pas être reproduit ou utilisé sans le consentement de EXM

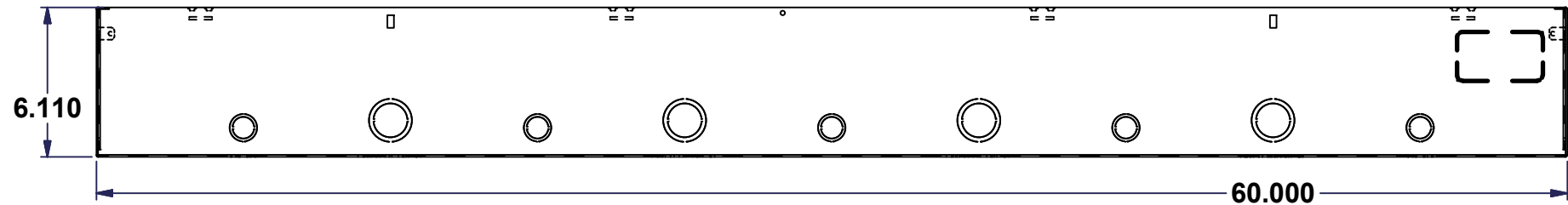
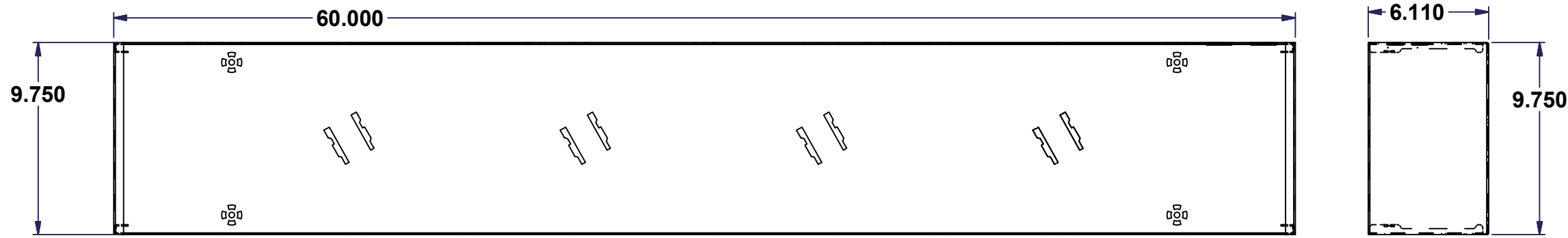

No.	Revisions	Date	By/Par
1	Redraw Model	11/08/2008	MichelP
2	Change Qty. tab on 400 & 600 AMP	08/12/2008	MichelP
3	Change for new hinge & change K-O size on 200 AMP	19/10/2009	MichelP
4	Turn into iLogic	20/4/2010	MichelP
5	Change sticker position and ground shape from 1.250 to 0.500	30/08/2010	AllenL

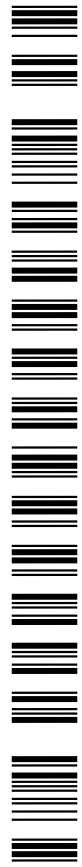
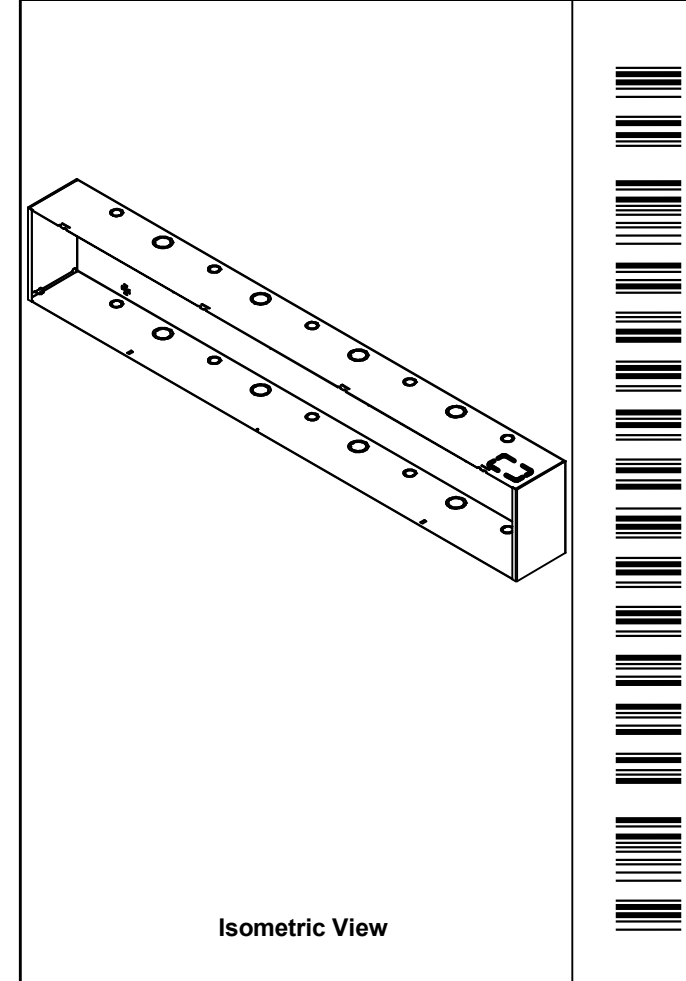

 Tél: (450) 979-4373 Fax: (450) 979-4626 www.exmweb.com		Flatness Aplatissement
		Max 3.0mm
Customer Client		Date
Drawn By Dessiné Par MichaelA		Date 10-Feb-15
Material Matière See Part List		
Color Couleur See Part List	Finish Fini See Part List	
Description 1100 T5403 body		Detail Rev.
Part Number Numéro Pièce 1100T5403B	Rev. 5	2 3

This drawing is confidential and must not be reproduced or used without the consent of EXM

All knockouts are actual size / Les disques défonçables sont grandeur réel
 All dimensions are before paint / Toutes les dimensions sont avant peinture

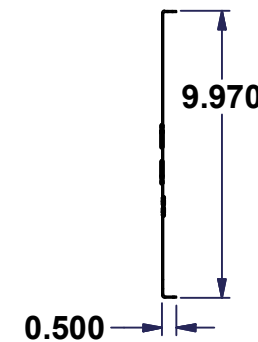
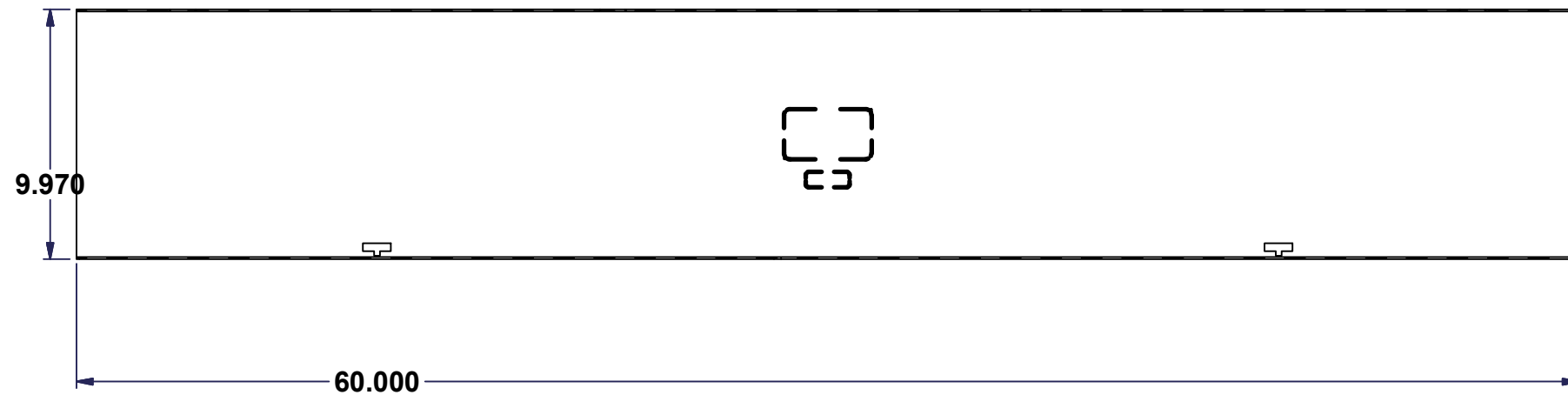

No.	Revisions	Date	By/Par
1	Redraw Model	11/08/2008	MichelP
2	Change Qty. tab on 400 & 600 AMP	08/12/2008	MichelP
3	change for new hinge & change K-O size on 200 AMP	19/10/2009	MichelP
4	Turn into iLogic	20/4/2010	MichelP
5	Change sticker position and ground shape from 1.250 to 0.500	30/08/2010	AllenL

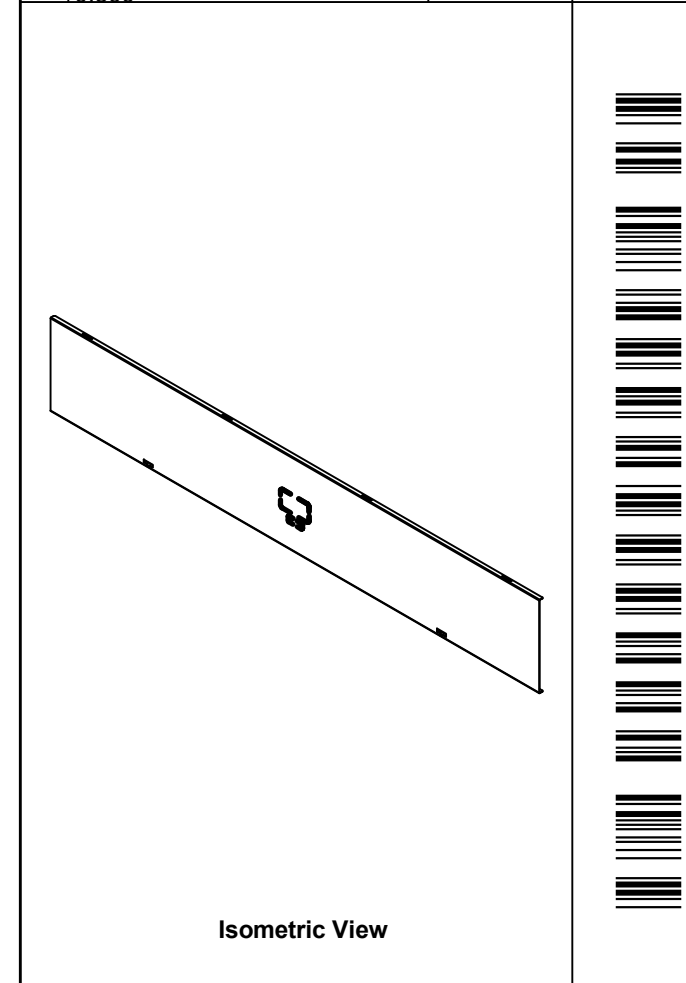

Ce dessin est confidentiel et ne doit pas être reproduit ou utilisé sans le consentement de EXM

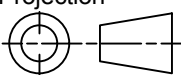
 Tél: (450) 979-4373 Fax: (450) 979-4626 www.exmweb.com		Flatness Aplatissement Max 3.0mm Projection 
Customer Client	Date	
Drawn By / Dessiné Par: MichaelA	Date: 10-Feb-15	
Material / Matière	See Part List	
Color / Couleur: See Part List	Finish / Fini: See Part List	
Description: 1100 T540 Cover	Detail Rev.	
Part Number / Numéro Pièce: 1100T540C	Rev. 5	3