

All knockouts are actual size / Les disques défonçables sont grandeur réel
 All dimensions are before paint / Toutes les dimensions sont avant peinture

This drawing is confidential and must not be reproduced or used without the consent of EXM

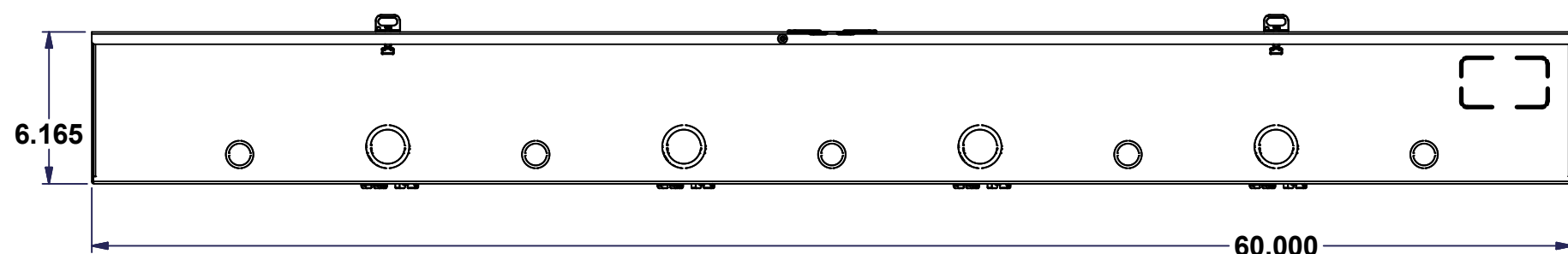

| No. | Revisions | Date | By/Par |
|-----|--|------------|---------|
| 1 | Redraw Model | 11/08/2008 | MichelP |
| 2 | Change Qty. tab on 400 & 600 AMP | 08/12/2008 | MichelP |
| 3 | Change for new hinge & change K-O size on 200 AMP | 19/10/2009 | MichelP |
| 4 | Turn into iLogic | 20/4/2010 | MichelP |
| 5 | Change sticker position and ground shape from 1.250 to 0.500 | 30/08/2010 | AllenL |

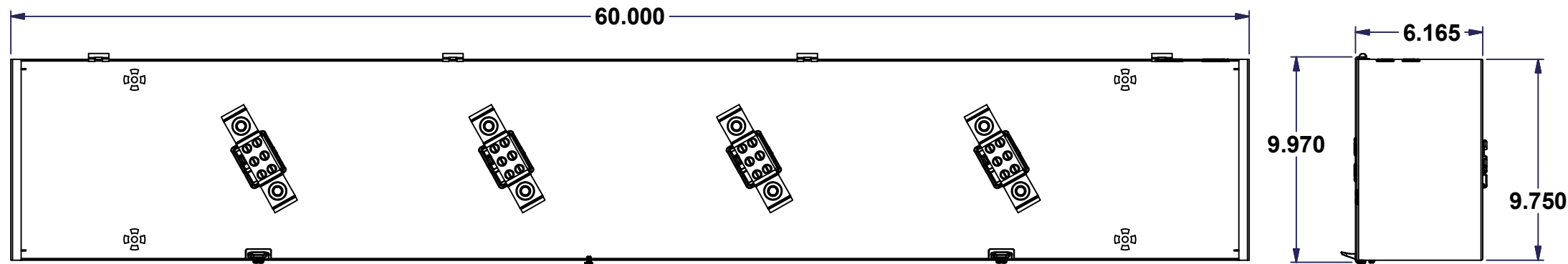
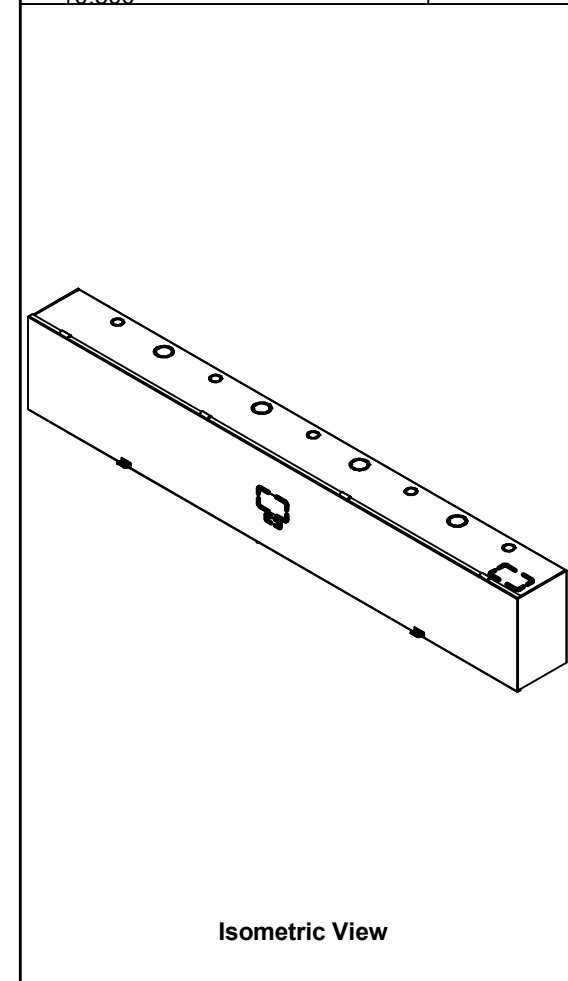

Ce dessin est confidentiel et ne doit pas être reproduit ou utilisé sans le consentement de EXM

| | | |
|--|------------------------------|---------------------------|
|  Tél: (450) 979-4373 Fax: (450) 979-4626 www.exmweb.com | | Flatness Aplatissement |
| | | Max 3.0mm |
| Customer Client | | Date |
| Drawn By Dessiné Par MichaelA | | Date 10-Feb-15 |
| Material Matière See Part List | | |
| Color Couleur See Part List | Finish Fini See Part List | |
| Description 1100 T5604 Assembly | | Detail Rev. |
| Part Number Numéro Pièce 1100T5604 | Rev. 5 | 1 3 |

All knockouts are actual size / Les disques défonçables sont grandeur réel
 All dimensions are before paint / Toutes les dimensions sont avant peinture

This drawing is confidential and must not be reproduced or used without the consent of EXM

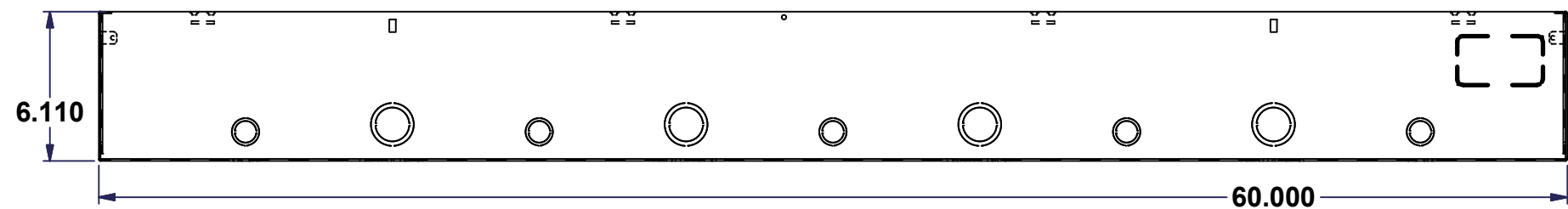
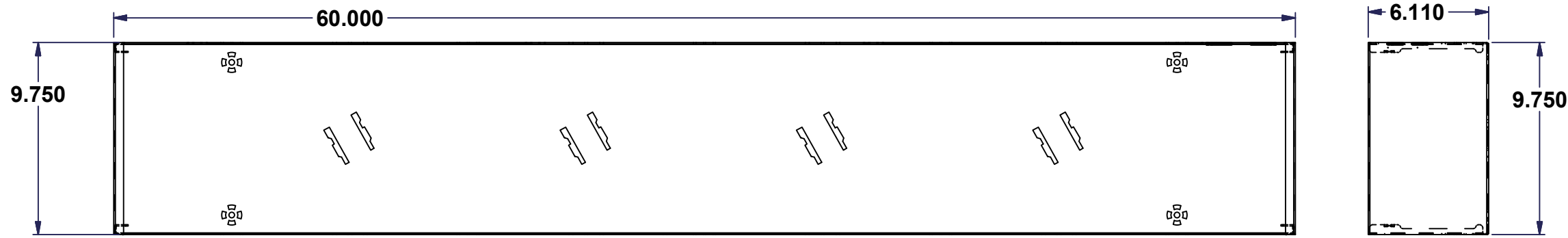

| No. | Revisions | Date | By/Par |
|-----|--|------------|---------|
| 1 | Redraw Model | 11/08/2008 | MichelP |
| 2 | Change Qty. tab on 400 & 600 AMP | 08/12/2008 | MichelP |
| 3 | Change for new hinge & change K-O size on 200 AMP | 19/10/2009 | MichelP |
| 4 | Turn into iLogic | 20/4/2010 | MichelP |
| 5 | Change sticker position and ground shape from 1.250 to 0.500 | 30/08/2010 | AllenL |

Isometric View

Ce dessin est confidentiel et ne doit pas être reproduit ou utilisé sans le consentement de EXM

| | | |
|--|------------------------------|---------------------------|
| Tél: (450) 979-4373 Fax: (450) 979-4626 www.exmweb.com | | Flatness Aplatissement |
| | | Max 3.0mm |
| Customer Client | | Date |
| Drawn By Dessiné Par MichaelA | | Date 10-Feb-15 |
| Material Matière See Part List | | |
| Color Couleur See Part List | Finish Fini See Part List | |
| Description 1100 T5604 body | | Detail Rev. |
| Part Number Numéro Pièce 1100T5604B | Rev. 5 | 2 3 |

This drawing is confidential and must not be reproduced or used without the consent of EXM

All knockouts are actual size / Les disques défonçables sont grandeur réel
 All dimensions are before paint / Toutes les dimensions sont avant peinture

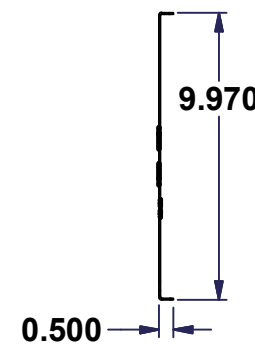
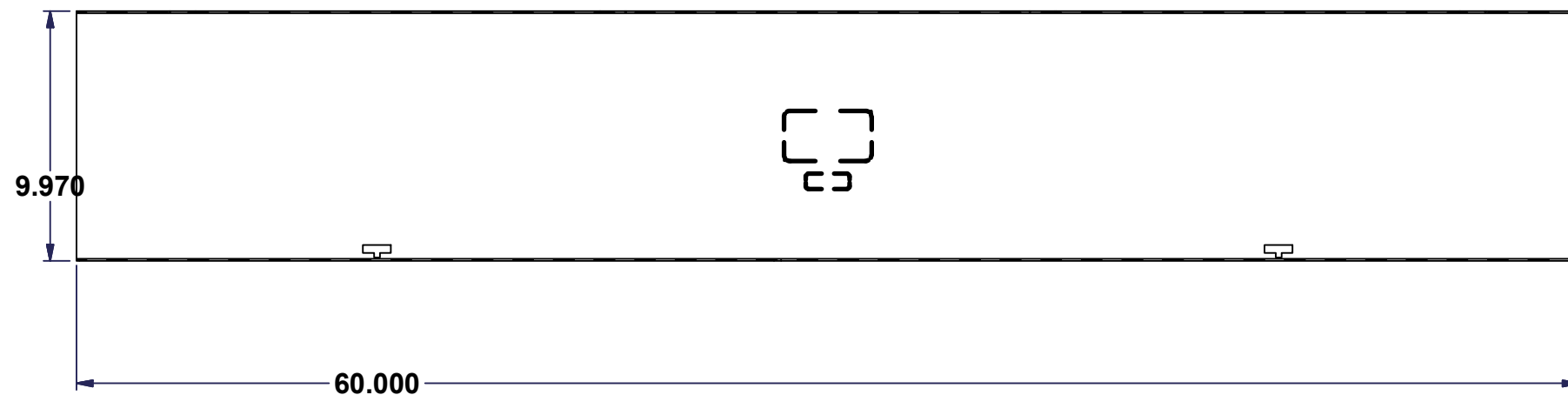

| No. | Revisions | Date | By/Par |
|-----|--|------------|---------|
| 1 | Redraw Model | 11/08/2008 | MichelP |
| 2 | Change Qty. tab on 400 & 600 AMP | 08/12/2008 | MichelP |
| 3 | change for new hinge & change K-O size on 200 AMP | 19/10/2009 | MichelP |
| 4 | Turn into iLogic | 20/4/2010 | MichelP |
| 5 | Change sticker position and ground shape from 1.250 to 0.500 | 30/08/2010 | AllenL |



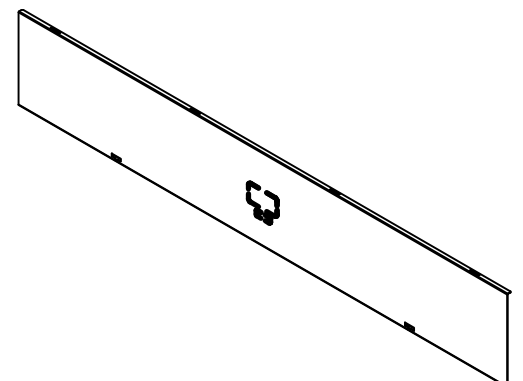

Isometric View

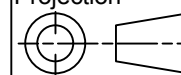
| | | |
|--|------------------|---|
|  Tél: (450) 979-4373 Fax: (450) 979-4626 www.exmweb.com | | Flatness Aplatissement Max 3.0mm Projection  |
| Customer Client | Date | |
| Drawn By Dessiné Par MichaelA | Date 10-Feb-15 | |
| Material Matière | See Part List | |
| Color Couleur | See Part List | Finish Fini See Part List |
| Description 1100 T560 Cover | | Detail Rev. |
| Part Number Numéro Pièce 1100T560C | Rev. 5 | 3 3 |

Ce dessin est confidentiel et ne doit pas être reproduit ou utilisé sans le consentement de EXM