

All knockouts are actual size / Les disques défonçables sont grandeur réel  
 All dimensions are before paint / Toutes les dimensions sont avant peinture

This drawing is confidential and must not be reproduced or used without the consent of EXM

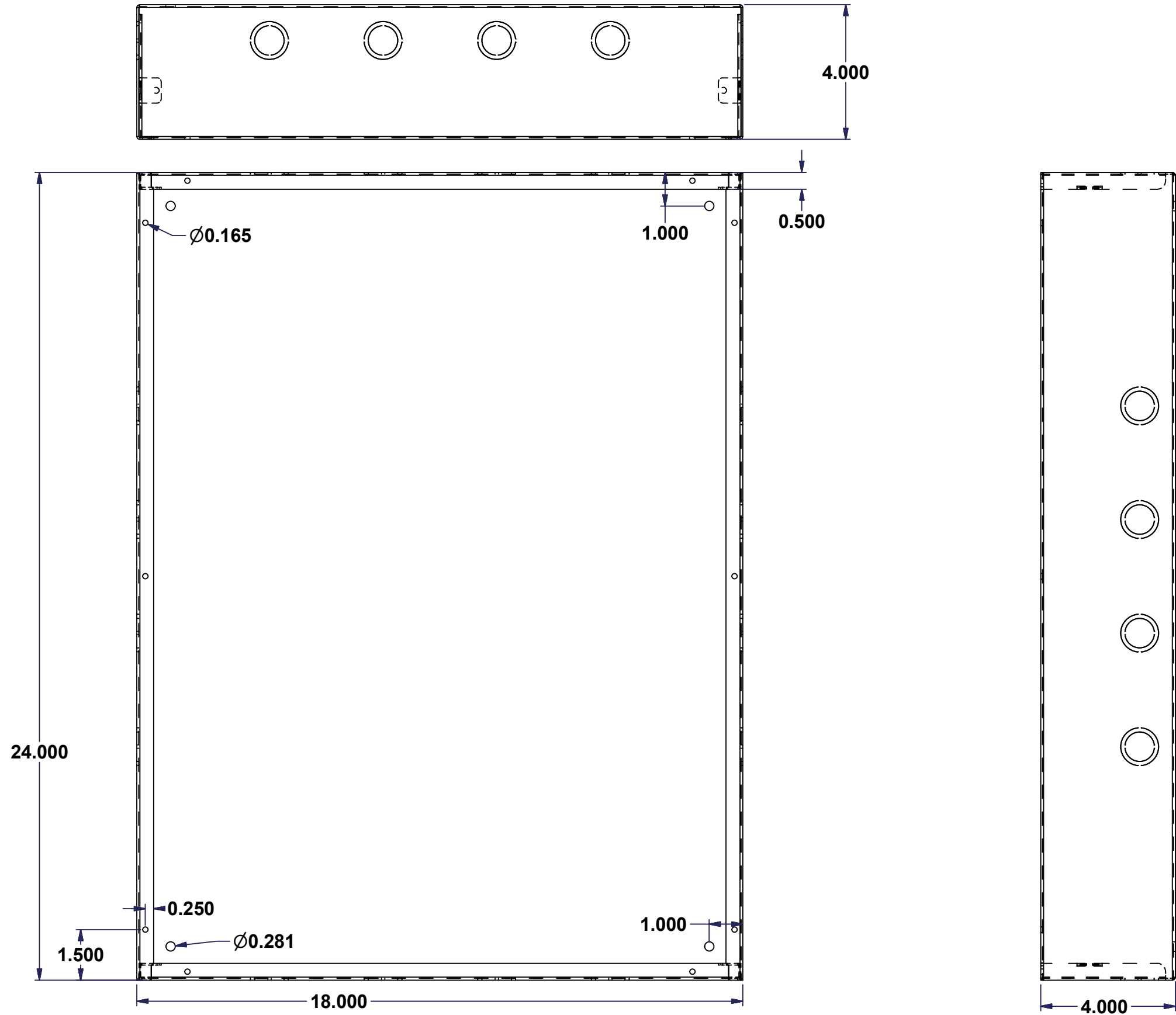

No.	Revisions	Date	By/Par
1	Turn into iLogic	12/27/2010	AllenL
1.1	Add lacer cut on grounding flange	20/01/2011	AllenL

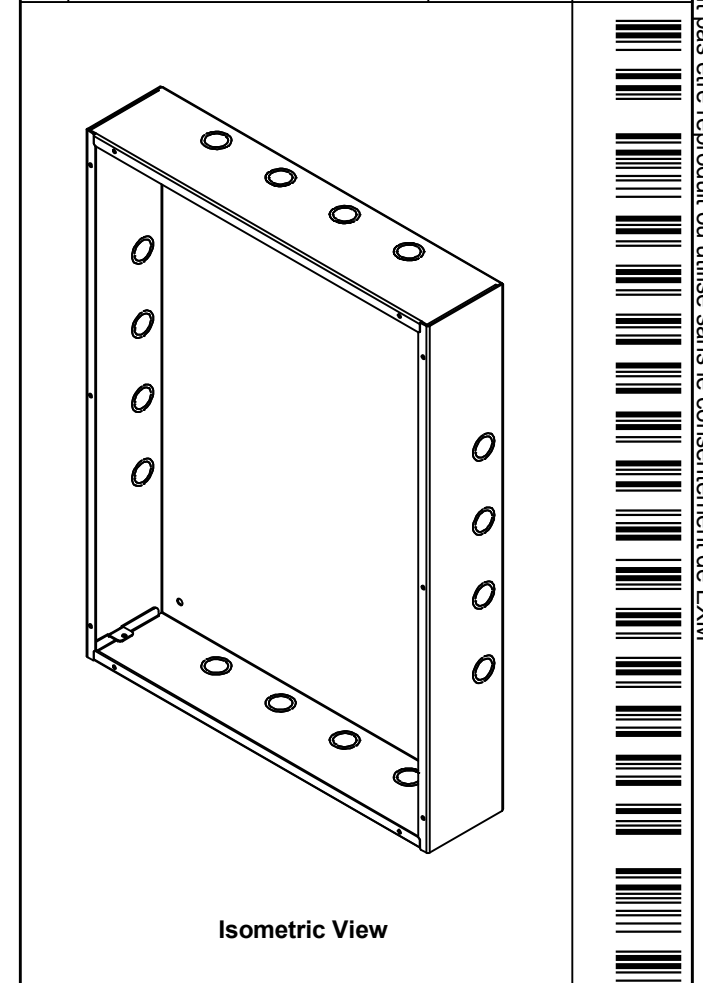

Ce dessin est confidentiel et ne doit pas être reproduit ou utilisé sans le consentement de EXM

Tél: (450) 979-4373 Fax: (450) 979-4626 <a href="http://www.exmweb.com">www.exmweb.com</a>		Flatness Aplatissement
		Max 3.0mm
Customer Client		Date
Drawn By Dessiné Par MichaelA		Date 10-Feb-15
Material Matière See Part List		
Color Couleur See Part List	Finish Fini See Part List	
Description 1100 TC 24" x 18" x 4" Assembly		Detail Rev.
Part Number Numéro Pièce <b>1100TC241804</b>	Rev. <b>1</b>	1 1