

This drawing is confidential and must not be reproduced or used without the consent of EXM

All knockouts are actual size / Les disques défonçables sont grandeur réel  
 All dimensions are before paint / Toutes les dimensions sont avant peinture

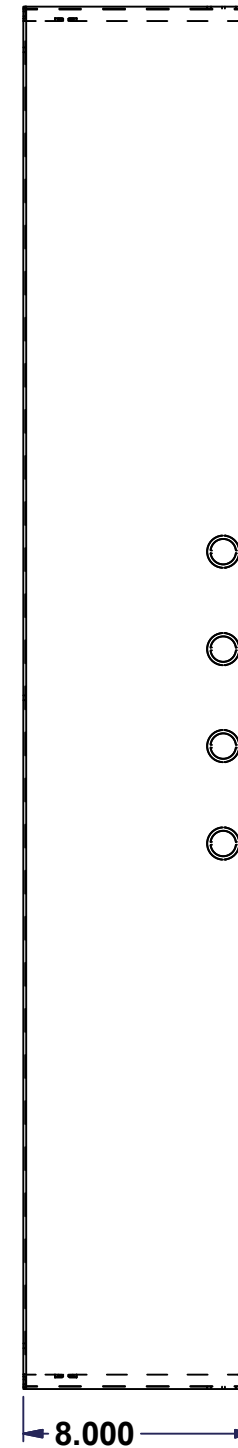

No.	Revisions	Date	By/Par
1	Turn into iLogic	12/27/2010	AllenL
1.1	Add lacer cut on grounding flange	20/01/2011	AllenL

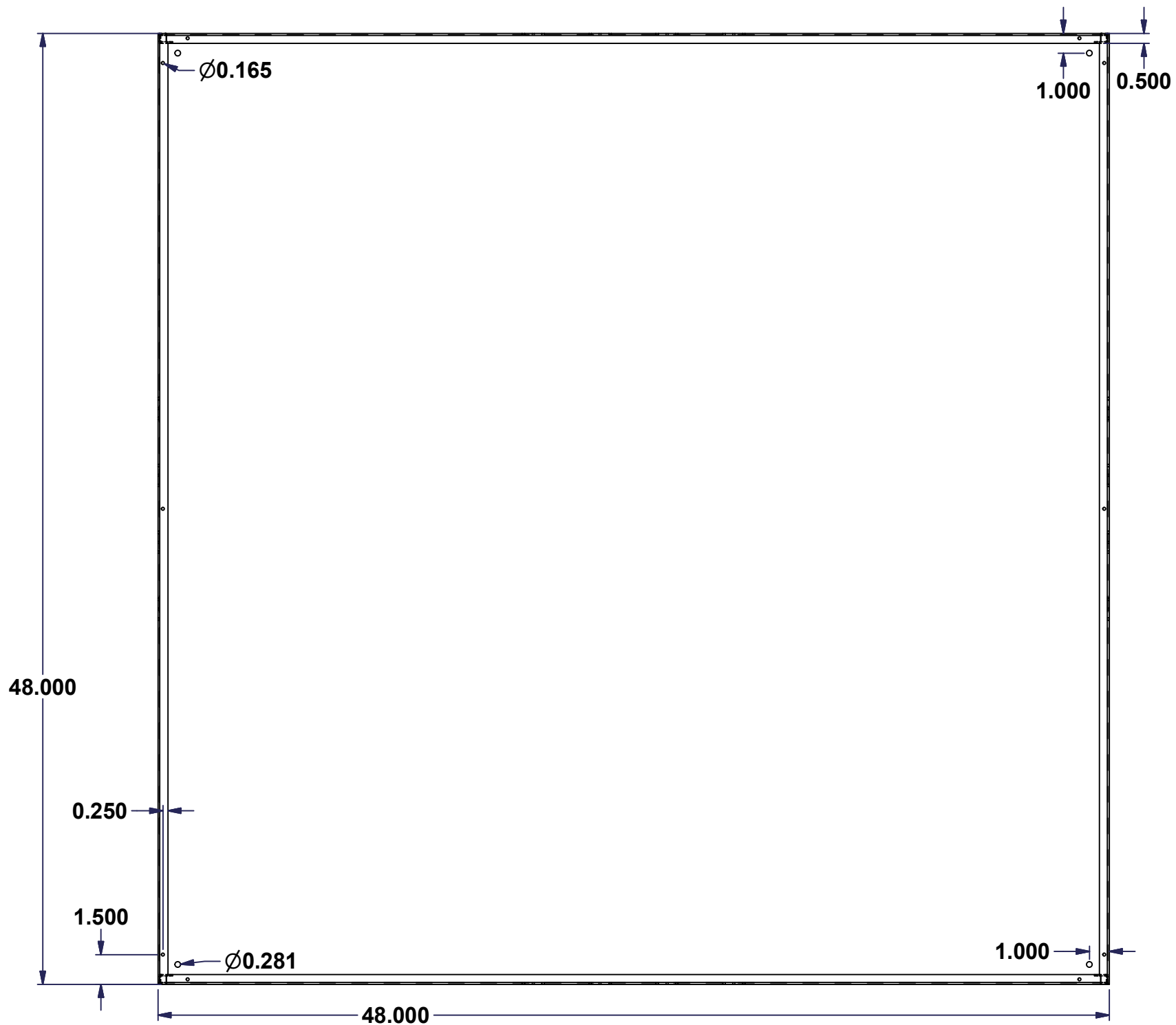
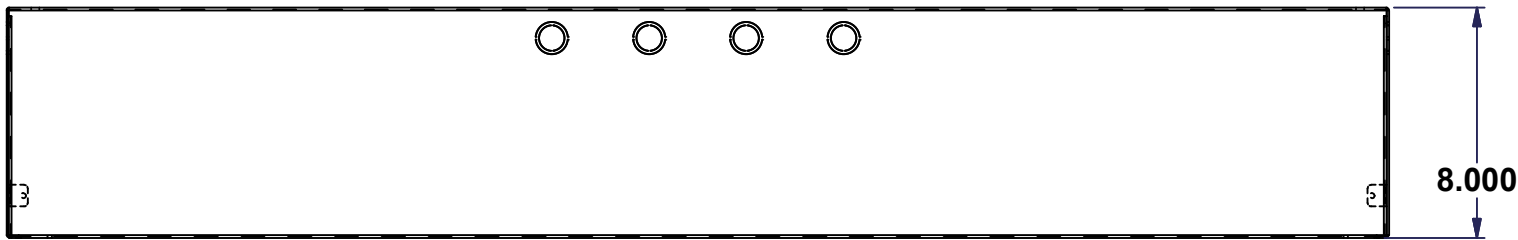
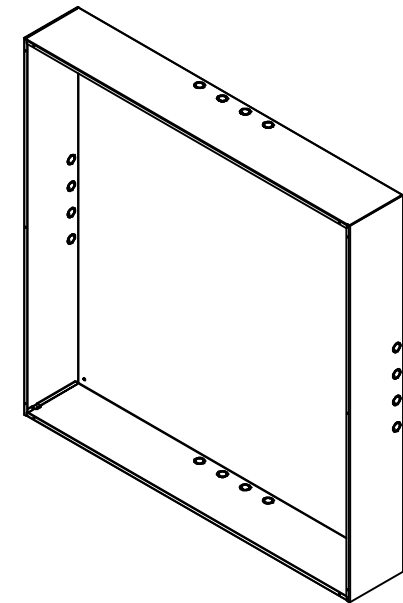

Isometric View

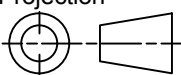

Ce dessin est confidentiel et ne doit pas être reproduit ou utilisé sans le consentement de EXM

 Tél: (450) 979-4373 Fax: (450) 979-4626 <a href="http://www.exmweb.com">www.exmweb.com</a>	Flatness Aplatissement	Max 3.0mm
	Projection	
Customer Client	Date	
Drawn By Dessiné Par MichaelA	Date	10-Feb-15
Material Matière	See Part List	
Color Couleur	See Part List	Finish Fini See Part List
Description	Detail Rev.	
1100 TC 48" x 48" x 8" Assembly		
Part Number Numéro Pièce	Rev.	1
<b>1100TC484808</b>	<b>1</b>	<b>1</b>