

This drawing is confidential and must not be reproduced or used without the consent of EXM

Ce dessin est confidentiel et ne doit pas être reproduit ou utilisé sans le consentement de EXM

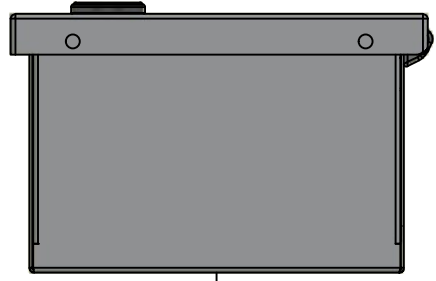

TOP



BACK

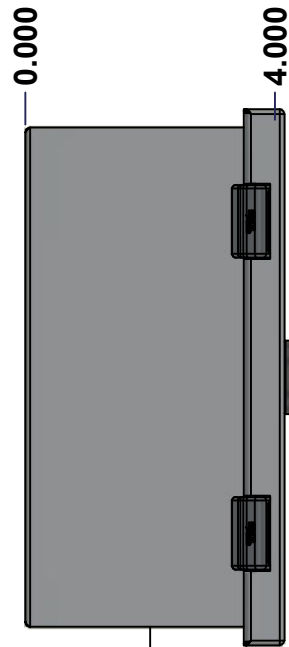

LEFT

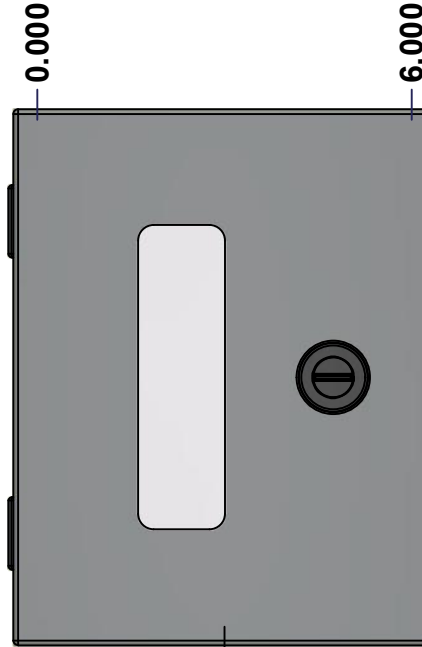

FRONT

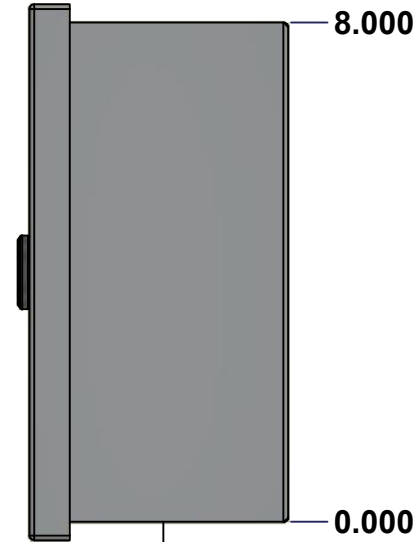

RIGHT

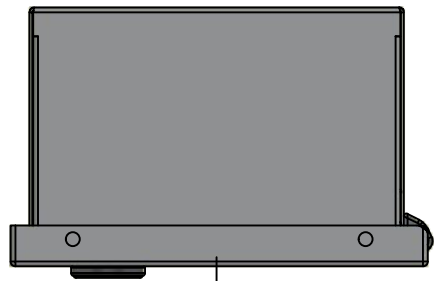

BOTTOM

No.	Revisions	Date	By/Par

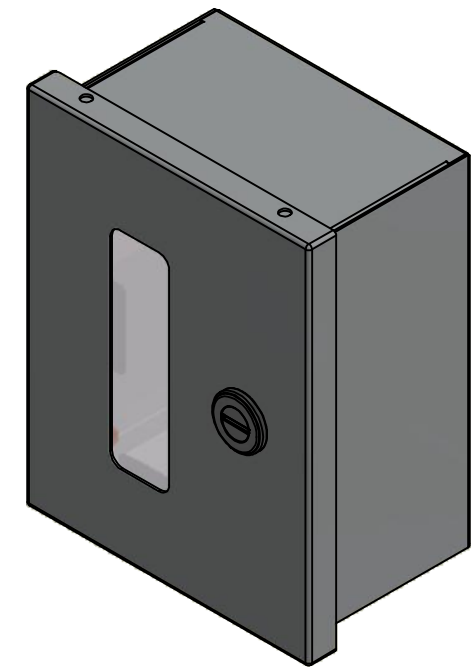

Isometric View



Tél: (450) 979-4373
 Fax: (450) 979-4626
www.exmweb.com

Flatness
Aplatissement

Max 3.0mm

Projection

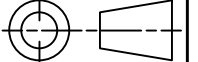

Customer Client	Date
Drawn By / Dessiné Par: BoxCad: BoxCad	Date: 26-Dec-13
Material / Matière: 16 Ga Cold Rolled A1008 CS Type B (1.4mm)	
Color / Couleur: Asa-61 Grey	Finish / Fini: Smooth
Description: 1100W 8" x 6" x 4" Assembly	Detail Rev.
Part Number / Numéro Pièce: 1100W080604	Rev. 0

SEE BILL OF MATERIAL ON LAST PAGE

This drawing is confidential and must not be reproduced or used without the consent of EXM

Ce dessin est confidentiel et ne doit pas être reproduit ou utilisé sans le consentement de EXM

NOTE	
ITEM	DESCRIPTION
1	NEMA 1 Enclosure
2	C/W Standard ground standoffs on box and cover
3	W/O Standard door stiffener
4	C/W Standard inner panel (Included)
5	C/W Standard inner panel mounting standoffs

No.	Revisions	Date	By/Par

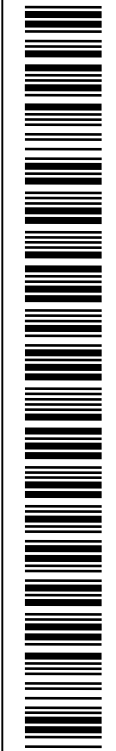
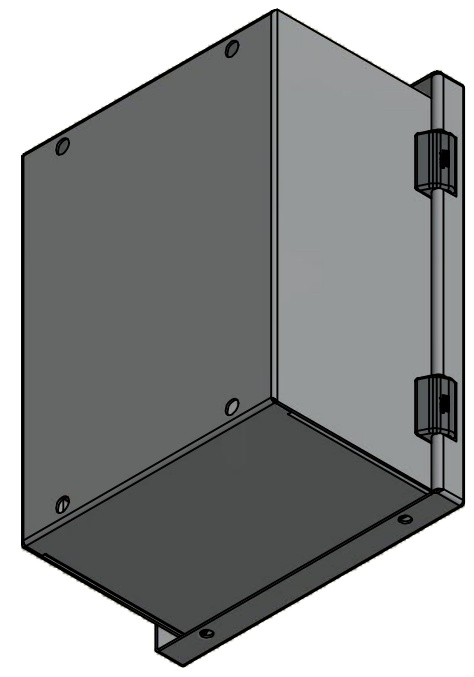

Isometric View



Tél: (450) 979-4373
 Fax: (450) 979-4626
www.exmweb.com

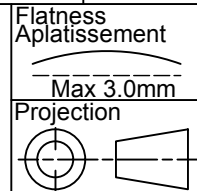

Customer Client	Date
Drawn By / Dessiné Par: BoxCad: BoxCad	Date: 26-Dec-13
Material / Matière: 16 Ga Cold Rolled A1008 CS Type B (1.4mm)	

Color / Couleur: Asa-61 Grey	Finish / Fini: Smooth
------------------------------	-----------------------

Description: 1100W 8" x 6" x 4" Assembly	Detail Rev.
--	-------------

Part Number / Numéro Pièce: 1100W080604	Rev. 0	2/8
--	--------	-----

Qty	Part Number	Rev	Description
1	1100W080604B	0	1100W 8" x 6" x 4" Body
1	1100W080604C	0	1100W 8" x 6" Cover
1	STK-K-00200	1	M6 x 8mm Hexagon/Slot Screw (Bag of 6)
1	880 SP0806	0	880 SP0806 - Inner Panel
2	STK-Q-08100	1	M5 Nylon Insert Lock Nut
Parts List			

PACKING		
ITEM	QTY	DESCRIPTION
Cardboard sleeve	1	Top
Thermal plastic film	1	Use with Packing Tunnel Wrapper Machine
Packaging label	1	White label with product number

This drawing is confidential and must not be reproduced or used without the consent of EXM

Ce dessin est confidentiel et ne doit pas être reproduit ou utilisé sans le consentement de EXM



TOP

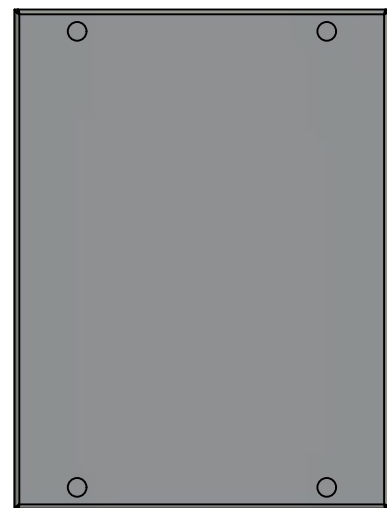

BACK



BOTTOM

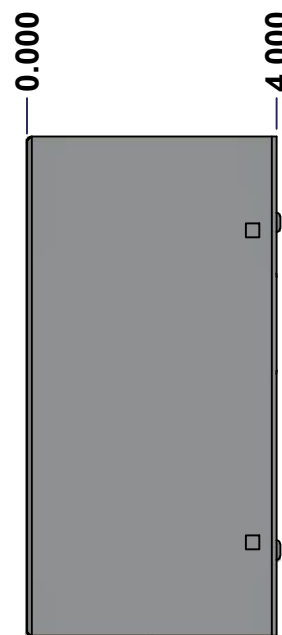

LEFT

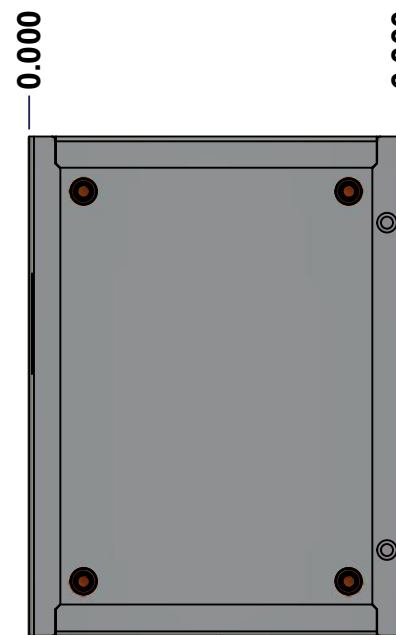

FRONT

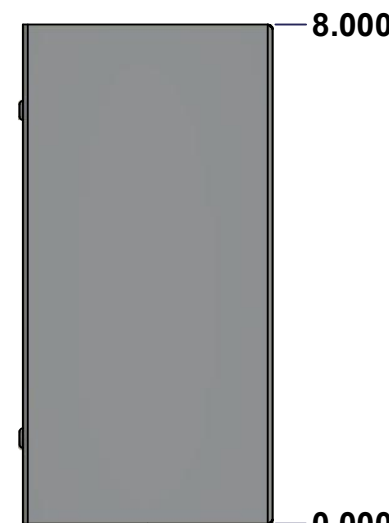

RIGHT

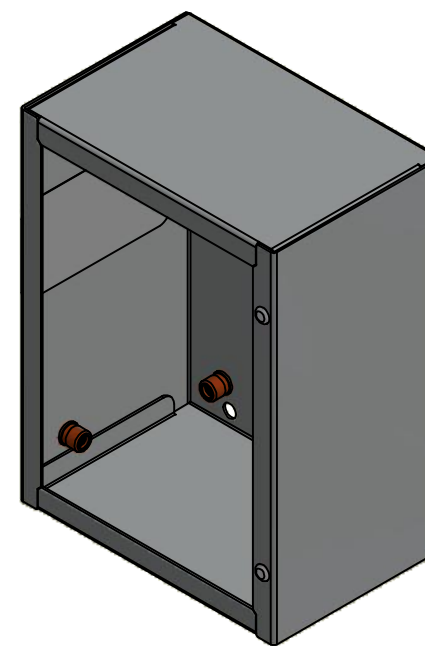

Isometric View

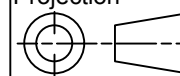

No.	Revisions	Date	By/Par

 Tél: (450) 979-4373 Fax: (450) 979-4626 www.exmweb.com		Flatness Aplatissement Max 3.0mm Projection 
Customer Client	Date	
Drawn By Dessiné Par	BoxCad: BoxCad	Date 26-Dec-13
Material Matière	16 Ga Cold Rolled A1008 CS Type B (1.4mm)	
Color Couleur	Asa-61 Grey	Finish Fini Smooth
Description	Detail Rev.	
1100W 8" x 6" x 4" Body		
Part Number Numéro Pièce	Rev.	3
1100W080604B	0	8

SEE BILL OF MATERIAL ON LAST PAGE

This drawing is confidential and must not be reproduced or used without the consent of EXM

Ce dessin est confidentiel et ne doit pas être reproduit ou utilisé sans le consentement de EXM

STANDARD FEATURES ARE NOT LISTED IN THIS HOLE TABLE

HOLE TABLE - BACK VIEW (CUSTOM FEATURE ONLY)

CUT-OUT	XDIM	YDIM	DESCRIPTION
1	0.875	7.125	IP STANDOFF M6 x 10mm (Inside)
2	0.875	0.875	IP STANDOFF M6 x 10mm (Inside)
3	5.125	0.875	IP STANDOFF M6 x 10mm (Inside)
4	5.125	7.125	IP STANDOFF M6 x 10mm (Inside)

5	5.000	0.344	RND Ø0.305
6	5.000	7.656	RND Ø0.305
7	1.000	7.656	RND Ø0.305
8	1.000	0.344	RND Ø0.305

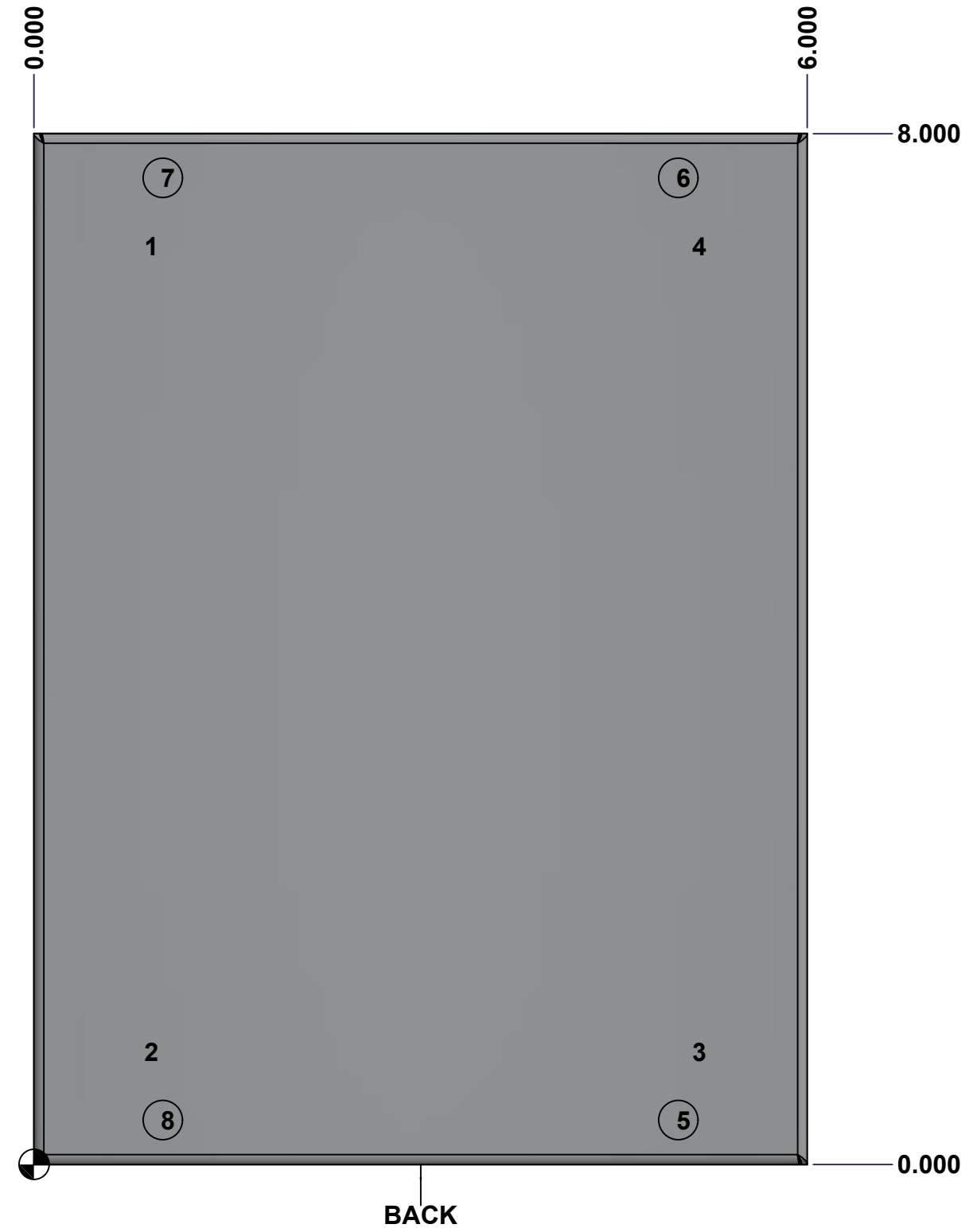

	Description	Status
	1100W 8" x 6" x 4" Body	(NULL)
	Part Number Numéro Pièce	Rev.
	1100W080604B	0 / 4 / 8

This drawing is confidential and must not be reproduced or used without the consent of EXM

Ce dessin est confidentiel et ne doit pas être reproduit ou utilisé sans le consentement de EXM

No.	Revisions	Date	By/Par

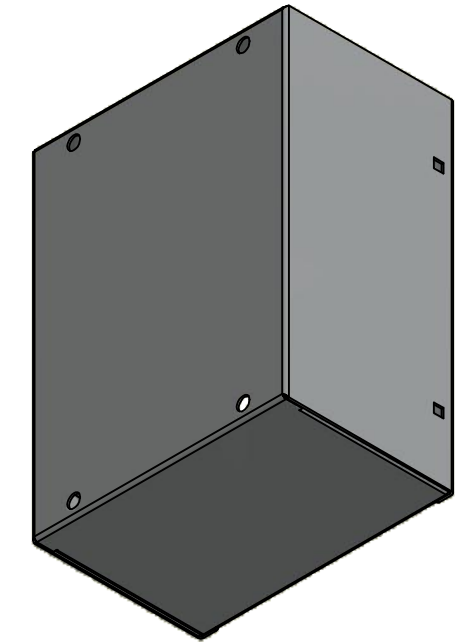

Isometric View

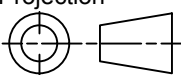
 Tél: (450) 979-4373 Fax: (450) 979-4626 www.exmweb.com		Flatness Aplatissement Max 3.0mm Projection 
Customer Client	Date	
Drawn By / Dessiné Par: BoxCad: BoxCad	Date: 26-Dec-13	
Material / Matière: 16 Ga Cold Rolled A1008 CS Type B (1.4mm)		
Color / Couleur: Asa-61 Grey	Finish / Fini: Smooth	
Description: 1100W 8" x 6" x 4" Body		Detail Rev.
Part Number / Numéro Pièce: 1100W080604B	Rev.:	5 / 8

Qty	Part Number	Rev	Description
1	STK-P-02400S	0	Powder Paint (Asa-61 Grey / Smooth)
1	STK-S-00100	0	3.5" x 2" Silver Milar Flexcon Sticker
2	STK-Q-77110	1	5412 ES Cover Plastic Plug
5	STK-Q-08350	5	Standoff M6 x 10mm
1	1100W080604B-P	0	1100W 8" x 6" x 4" Body Part
Parts List			

This drawing is confidential and must not be reproduced or used without the consent of EXM

Ce dessin est confidentiel et ne doit pas être reproduit ou utilisé sans le consentement de EXM

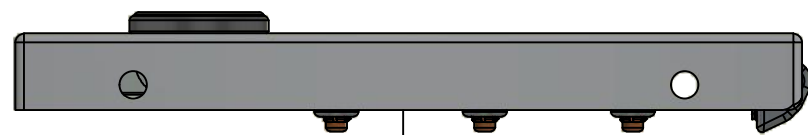

TOP

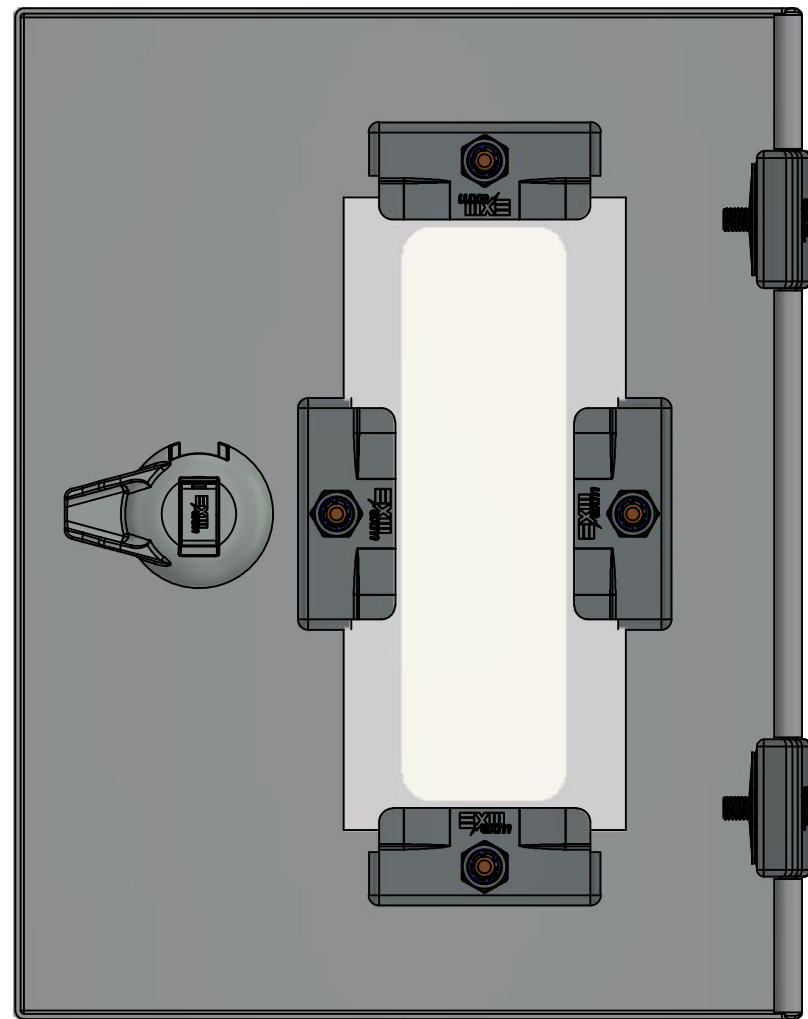

BACK

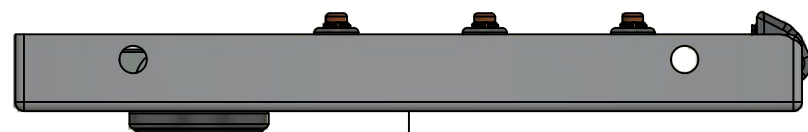

BOTTOM

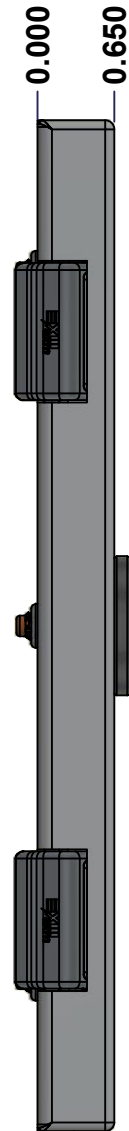

LEFT



FRONT

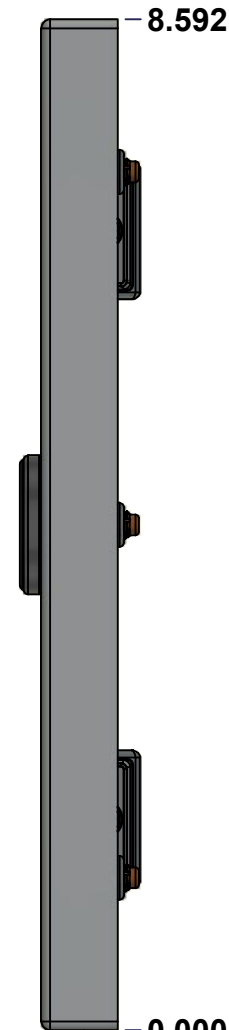

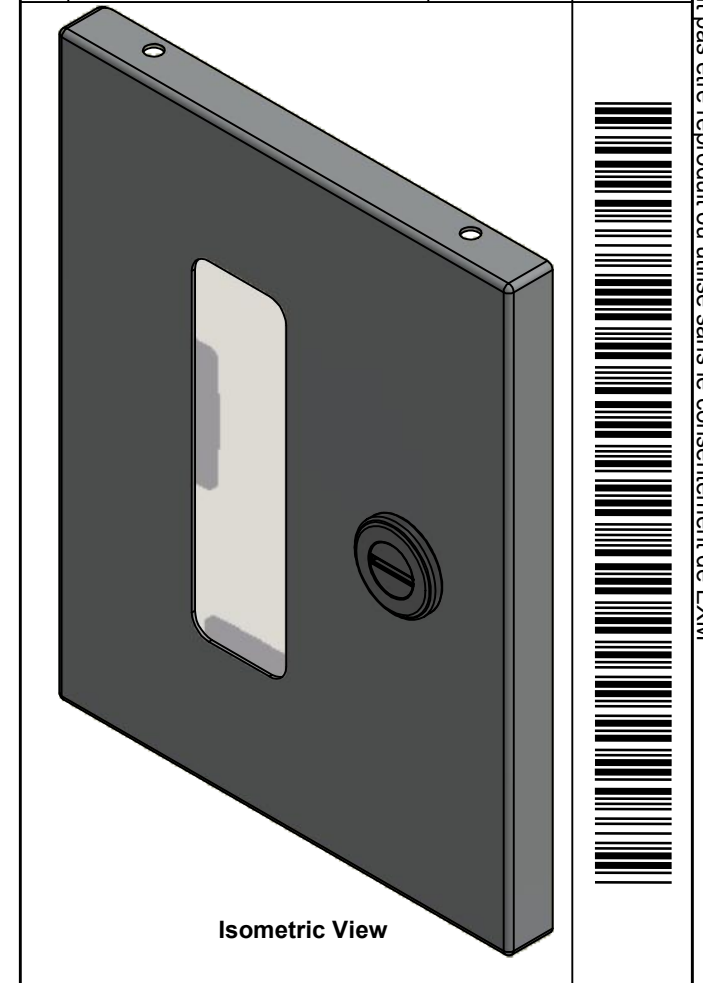

RIGHT

No.	Revisions	Date	By/Par

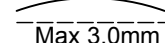

Isometric View

 Tél: (450) 979-4373 Fax: (450) 979-4626 www.exmweb.com		Flatness Aplatissement  Max 3.0mm Projection 
Customer Client	Date	
Drawn By Dessiné Par	BoxCad: BoxCad	Date 26-Dec-13
Material Matière	16 Ga Cold Rolled A1008 CS Type B (1.4mm)	
Color Couleur	Asa-61 Grey	Finish Fini Smooth
Description	Detail Rev.	
1100W 8" x 6" Cover		
Part Number Numéro Pièce	Rev. 0	6 / 8
1100W080604C		

SEE BILL OF MATERIAL ON LAST PAGE

This drawing is confidential and must not be reproduced or used without the consent of EXM

Ce dessin est confidentiel et ne doit pas être reproduit ou utilisé sans le consentement de EXM

STANDARD FEATURES ARE NOT LISTED IN THIS HOLE TABLE			
HOLE TABLE - FRONT VIEW (CUSTOM FEATURE ONLY)			
CUT-OUT	XDIM	YDIM	DESCRIPTION
1	5.125	4.296	LOCK 880 SCQ1-SLZ @ 0.0°

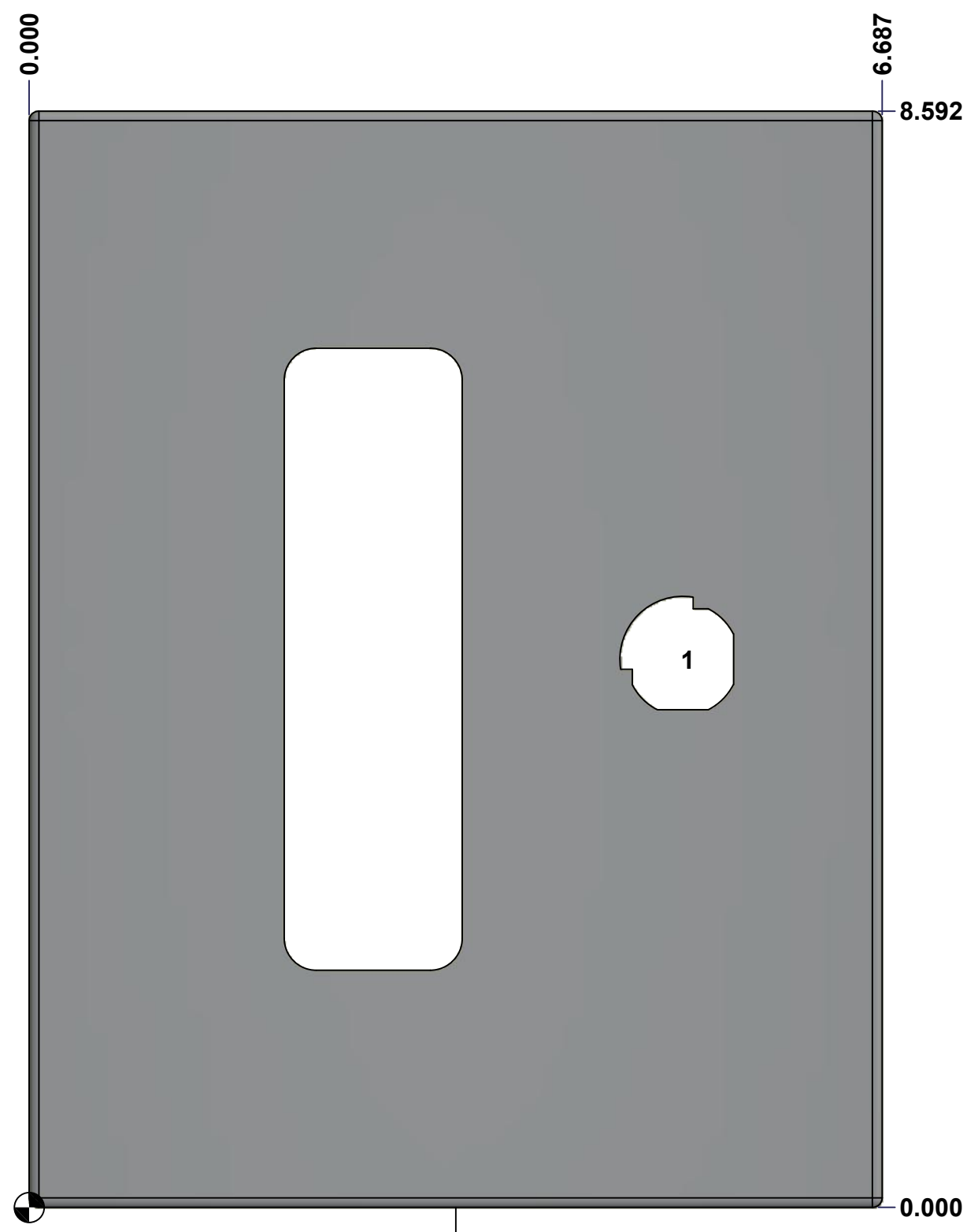

FRONT

	Description	Status	
	1100W 8" x 6" x 4" Cover	(NULL)	
	Part Number Numéro Pièce	Rev.	
	1100W080604C	0	7/8

This drawing is confidential and must not be reproduced or used without the consent of EXM

Ce dessin est confidentiel et ne doit pas être reproduit ou utilisé sans le consentement de EXM

No.	Revisions	Date	By/Par

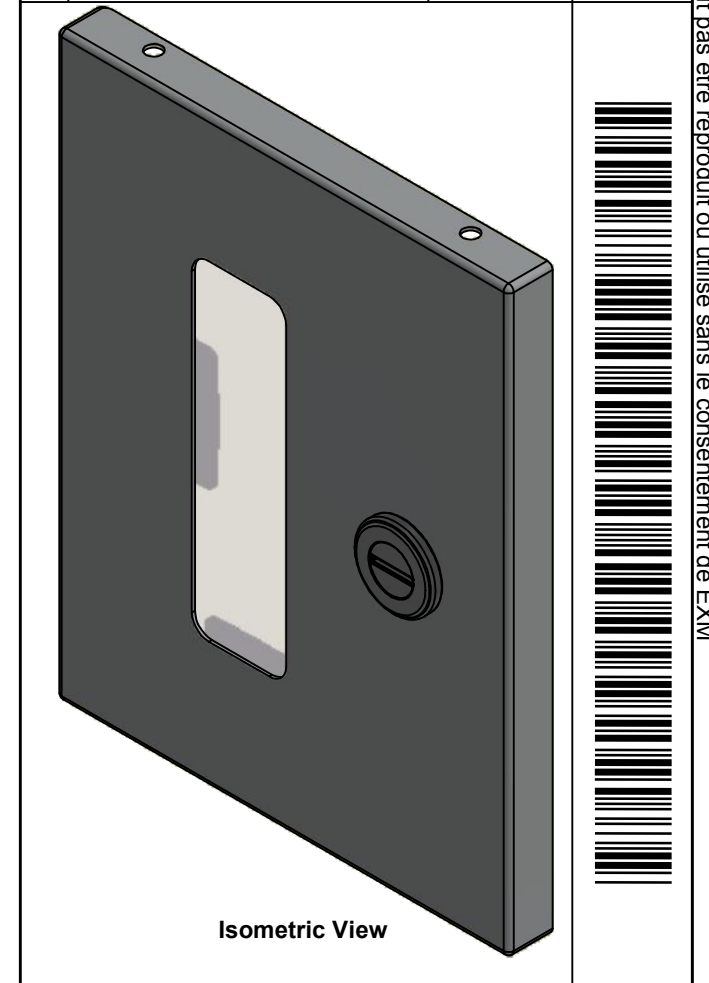

Tél: (450) 979-4373 Fax: (450) 979-4626 www.exmweb.com		Flatness Aplatissement	
		Max 3.0mm	
Customer Client		Date	
Drawn By Dessiné Par BoxCad: BoxCad		Date 26-Dec-13	
Material Matière 16 Ga Cold Rolled A1008 CS Type B (1.4mm)			
Color Couleur Asa-61 Grey		Finish Fini Smooth	
Description 1100W 8" x 6" Cover			Detail Rev.
Part Number Numéro Pièce 1100W080604C		Rev. 0	8 8

1	880 SCQ1-SLZ	0	1100 1/4 Turn Lock
4	STK-Q-60702	1	880 WK - Lexan 1/4" Fixing Bracket
4	STK-Q-16055	1	M6 x 18mm Stud (No Paint Cap Required)
1	1100W080604LX	0	1100W 8" x 6" x 4" Lexan
1	STK-P-02400S	0	Powder Paint (Asa-61 Grey / Smooth)
1	1100W080604C-P	0	1100W 8" x 6" x 4" Cover Part
2	STK-A-33033	4	5412 ESMCH Hinge
Qty	Part Number	Rev	Description
Parts List			

This drawing is confidential and must not be reproduced or used without the consent of EXM

Ce dessin est confidentiel et ne doit pas être reproduit ou utilisé sans le consentement de EXM

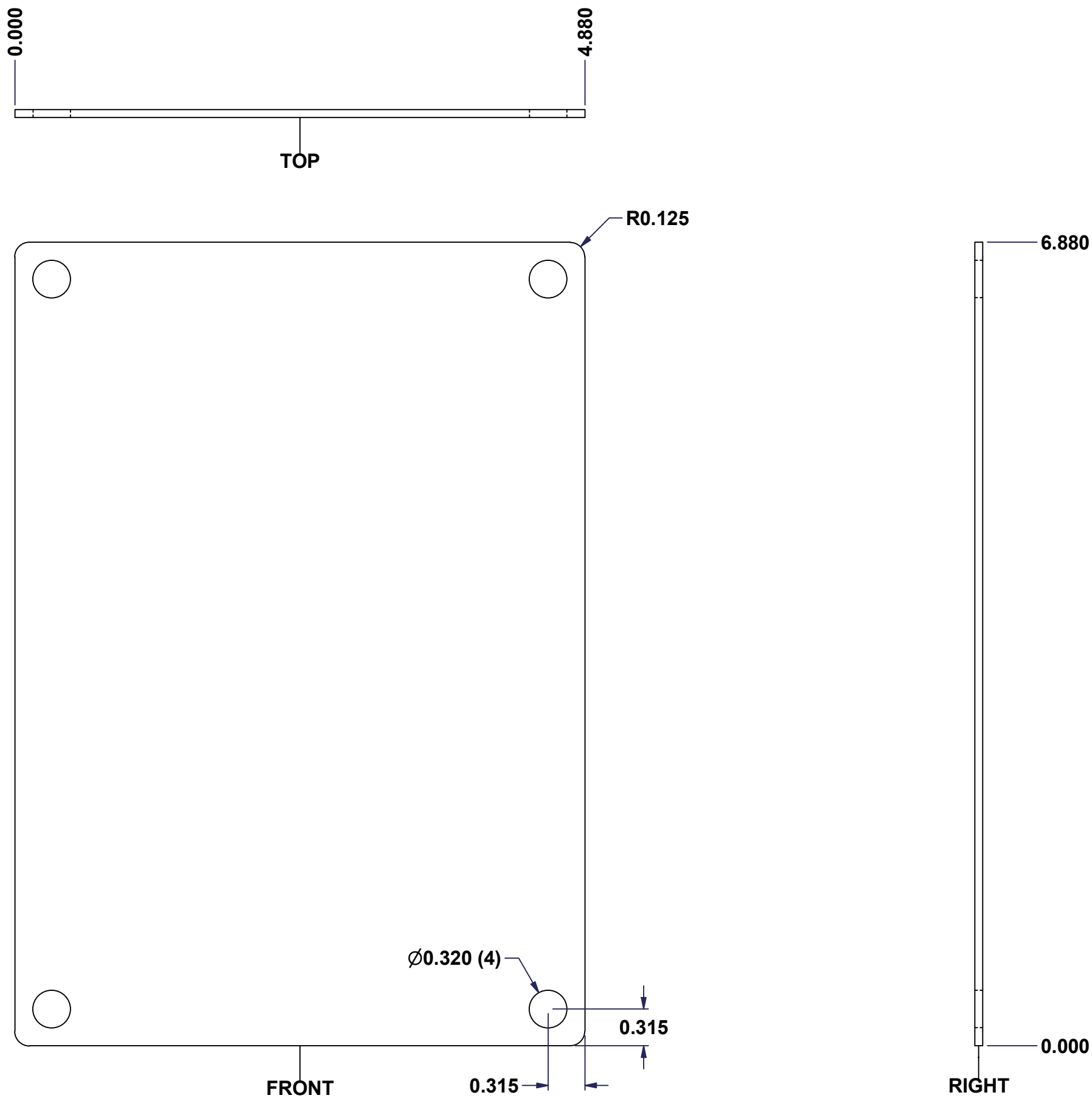

No.	Revisions	Date	By/Par

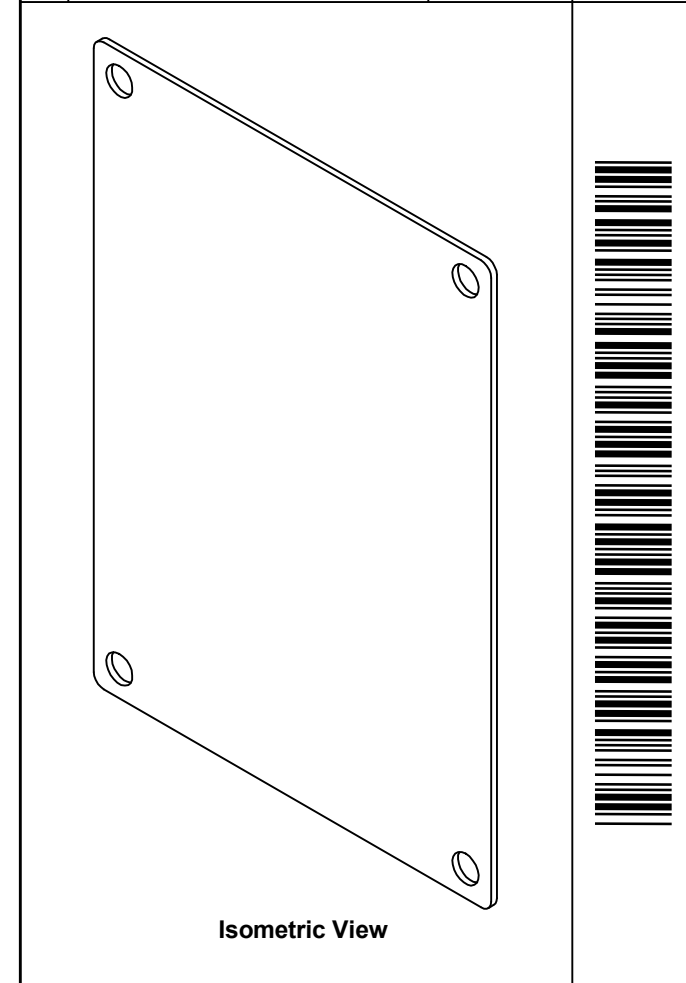

<p>Tél: (450) 979-4373 Fax: (450) 979-4626 www.exmweb.com</p>	Flatness Aplatissement Max 3.0mm
	Projection
Customer Client	Date
Drawn By Dessiné Par BoxCad	Date 23-Jan-07
Material Matière 14 Ga Cold Rolled A1008 CS Type B	
Color Couleur White	Finish Fini Smooth
Description 880 SP0806 - Inner Panel	
Part Number Numéro Pièce 880 SP0806	Detail Rev. Rev. 1 0 2

SEE BILL OF MATERIAL ON LAST PAGE

This drawing is confidential and must not be reproduced or used without the consent of EXM

Ce dessin est confidentiel et ne doit pas être reproduit ou utilisé sans le consentement de EXM

No.	Revisions	Date	By/Par

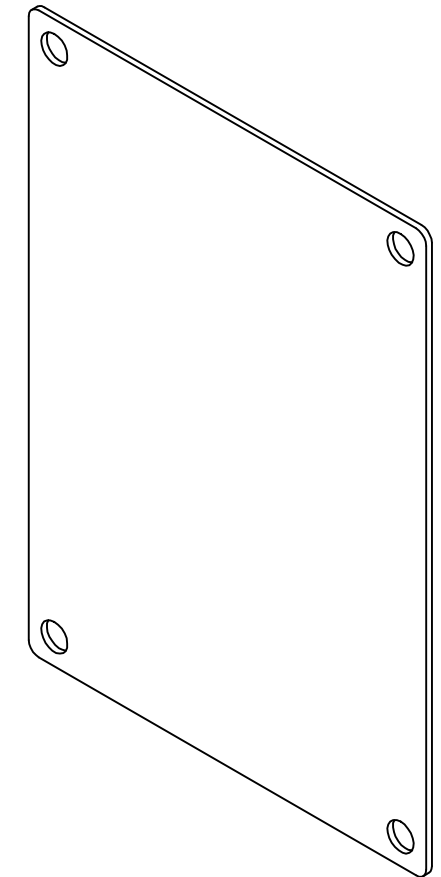

Isometric View



 Tél: (450) 979-4373 Fax: (450) 979-4626 www.exmweb.com		Flatness Aplatissement Max 3.0mm
Customer Client		Date
Drawn By / Dessiné Par: BoxCad		Date: 23-Jan-07
Material / Matière: 14 Ga Cold Rolled A1008 CS Type B		
Color / Couleur: White		Finish / Fini: Smooth
Description: 880 SP0806 - Inner Panel		Detail Rev.
Part Number / Numéro Pièce: 880 SP0806		Rev. 0 / 2

Qty	Part Number	Rev	Description
1	STK-P-02401S	0	Powder Paint (White / Smooth)
1	880 SP0806-P	0	880 SP0806 - Inner Panel Part
Parts List			