

This drawing is confidential and must not be reproduced or used without the consent of EXM

Ce dessin est confidentiel et ne doit pas être reproduit ou utilisé sans le consentement de EXM



TOP



BACK



LEFT

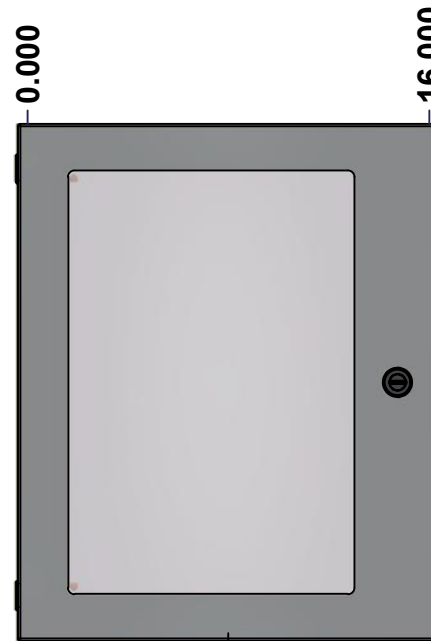

FRONT

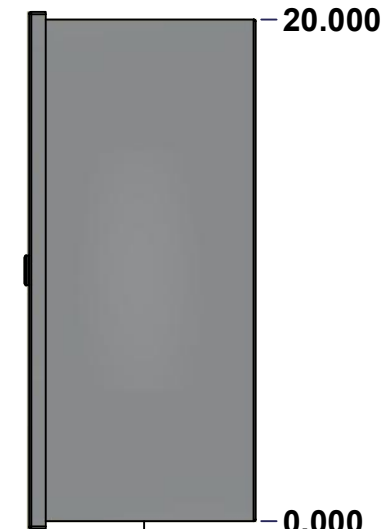

RIGHT



BOTTOM

No.	Revisions	Date	By/Par

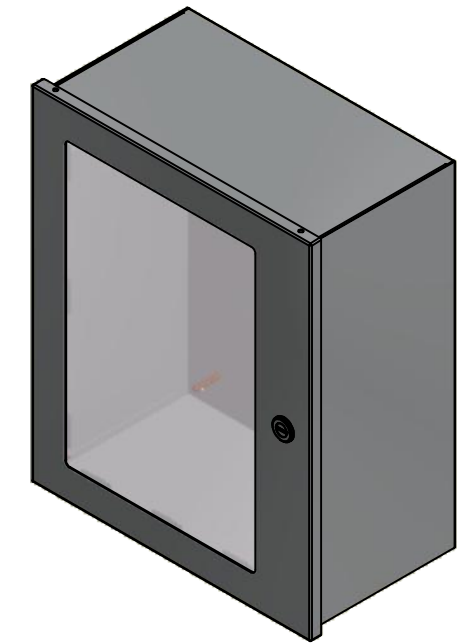

Isometric View



Tél: (450) 979-4373
 Fax: (450) 979-4626
www.exmweb.com

Flatness
Aplatissement

Max 3.0mm

Projection

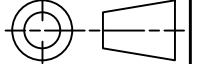

Customer Client	Date
Drawn By / Dessiné Par: BoxCad: BoxCad	Date: 27-Dec-13
Material / Matière: 16 Ga Cold Rolled A1008 CS Type B (1.4mm)	
Color / Couleur: Asa-61 Grey	Finish / Fini: Smooth
Description: 1100W 20" x 16" x 8.87" Assembly	Detail Rev.
Part Number / Numéro Pièce: 1100W201608	Rev. 0

SEE BILL OF MATERIAL ON LAST PAGE

This drawing is confidential and must not be reproduced or used without the consent of EXM

Ce dessin est confidentiel et ne doit pas être reproduit ou utilisé sans le consentement de EXM

NOTE	
ITEM	DESCRIPTION
1	NEMA 1 Enclosure
2	C/W Standard ground studs on box and cover
3	W/O Standard door stiffener
4	W/O Inner panel
5	C/W Standard inner panel mounting studs

No.	Revisions	Date	By/Par

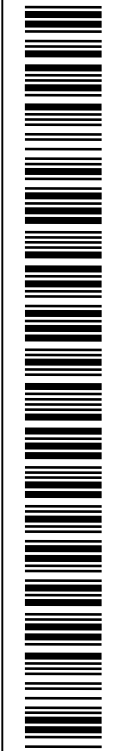
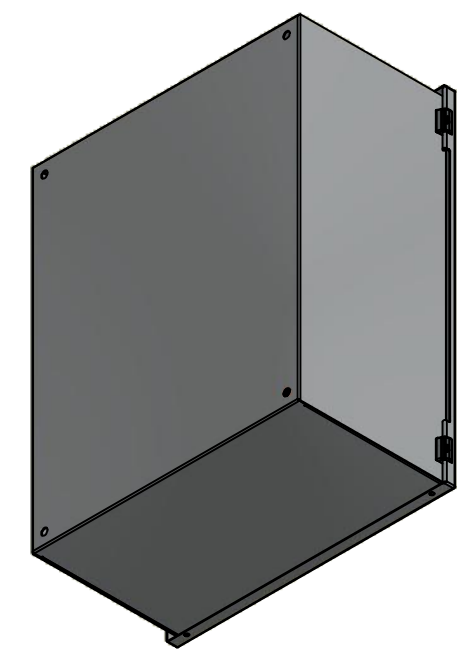

Isometric View



Tél: (450) 979-4373
 Fax: (450) 979-4626
www.exmweb.com

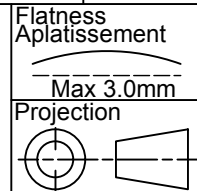

Customer Client	Date
Drawn By / Dessiné Par: BoxCad: BoxCad	Date: 27-Dec-13
Material / Matière: 16 Ga Cold Rolled A1008 CS Type B (1.4mm)	
Color / Couleur: Asa-61 Grey	Finish / Fini: Smooth

PACKING		
ITEM	QTY	DESCRIPTION
Cardboard sleeve	1	Top
Thermal plastic film	1	Use with Packing Tunnel Wrapper Machine
Packaging label	1	White label with product number

1	1100W201608B	0	1100W 20" x 16" x 8.87" Body
1	1100W201608C	0	1100W 20" x 16" Cover
2	STK-Q-08100	1	M5 Nylon Insert Lock Nut
Qty	Part Number	Rev	Description
Parts List			

Description: 1100W 20" x 16" x 8.87" Assembly	Detail Rev.
Part Number / Numéro Pièce: 1100W201608	Rev. 0 / 2 / 8

This drawing is confidential and must not be reproduced or used without the consent of EXM

Ce dessin est confidentiel et ne doit pas être reproduit ou utilisé sans le consentement de EXM



TOP



BACK

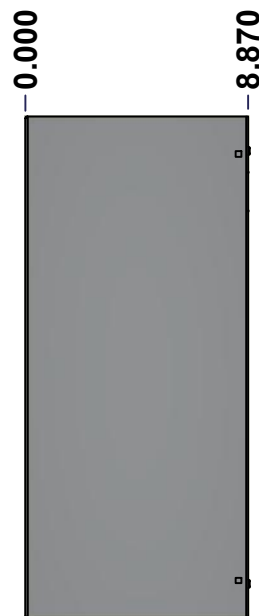

LEFT

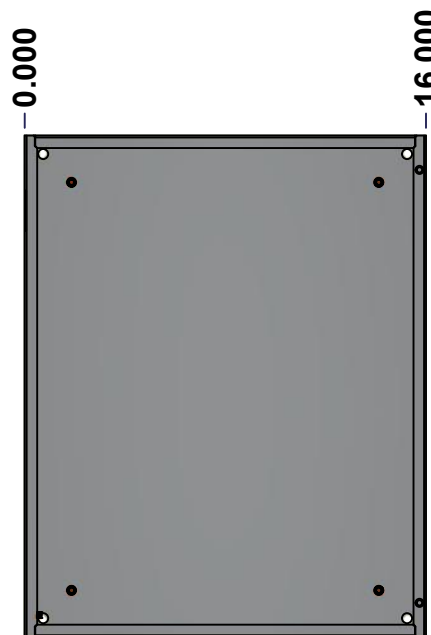

FRONT

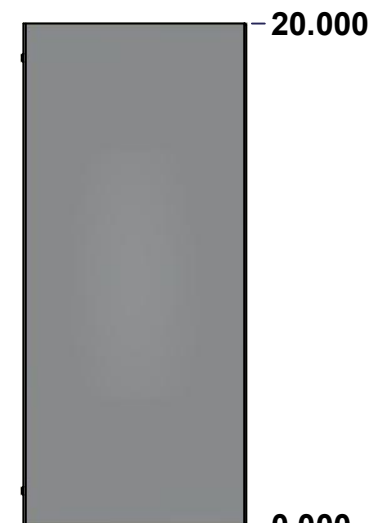

RIGHT



BOTTOM

No.	Revisions	Date	By/Par

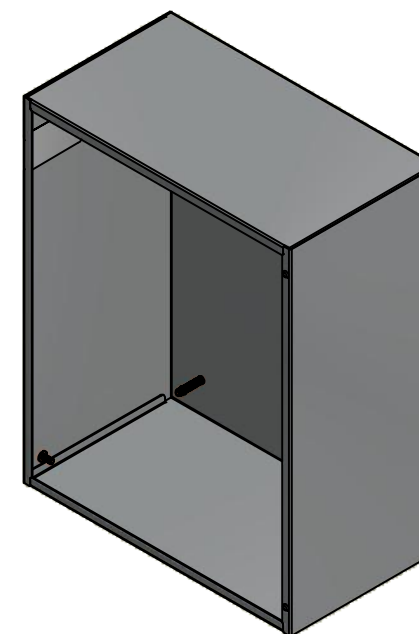

Isometric View



Tél: (450) 979-4373
 Fax: (450) 979-4626
www.exmweb.com

Flatness
Aplatissement

Max 3.0mm

Projection



Customer Client	Date
Drawn By / Dessiné Par: BoxCad: BoxCad	Date: 27-Dec-13
Material / Matière: 16 Ga Cold Rolled A1008 CS Type B (1.4mm)	

Color / Couleur: Asa-61 Grey	Finish / Fini: Smooth
------------------------------	-----------------------

Description: 1100W 20" x 16" x 8.87" Body	Detail Rev.
---	-------------

Part Number / Numéro Pièce: 1100W201608B	Rev. 0	3 / 8
--	--------	-------

SEE BILL OF MATERIAL ON LAST PAGE

This drawing is confidential and must not be reproduced or used without the consent of EXM

Ce dessin est confidentiel et ne doit pas être reproduit ou utilisé sans le consentement de EXM

STANDARD FEATURES ARE NOT LISTED IN THIS HOLE TABLE

HOLE TABLE - BACK VIEW (CUSTOM FEATURE ONLY)

CUT-OUT	XDIM	YDIM	DESCRIPTION
1	1.875	18.125	IP STUD M8 x 35mm (Inside)
2	1.875	1.875	IP STUD M8 x 35mm (Inside)
3	14.125	1.875	IP STUD M8 x 35mm (Inside)
4	14.125	18.125	IP STUD M8 x 35mm (Inside)

5	15.250	0.750	RND Ø0.390
6	15.250	19.250	RND Ø0.390
7	0.750	19.250	RND Ø0.390
8	0.750	0.750	RND Ø0.390

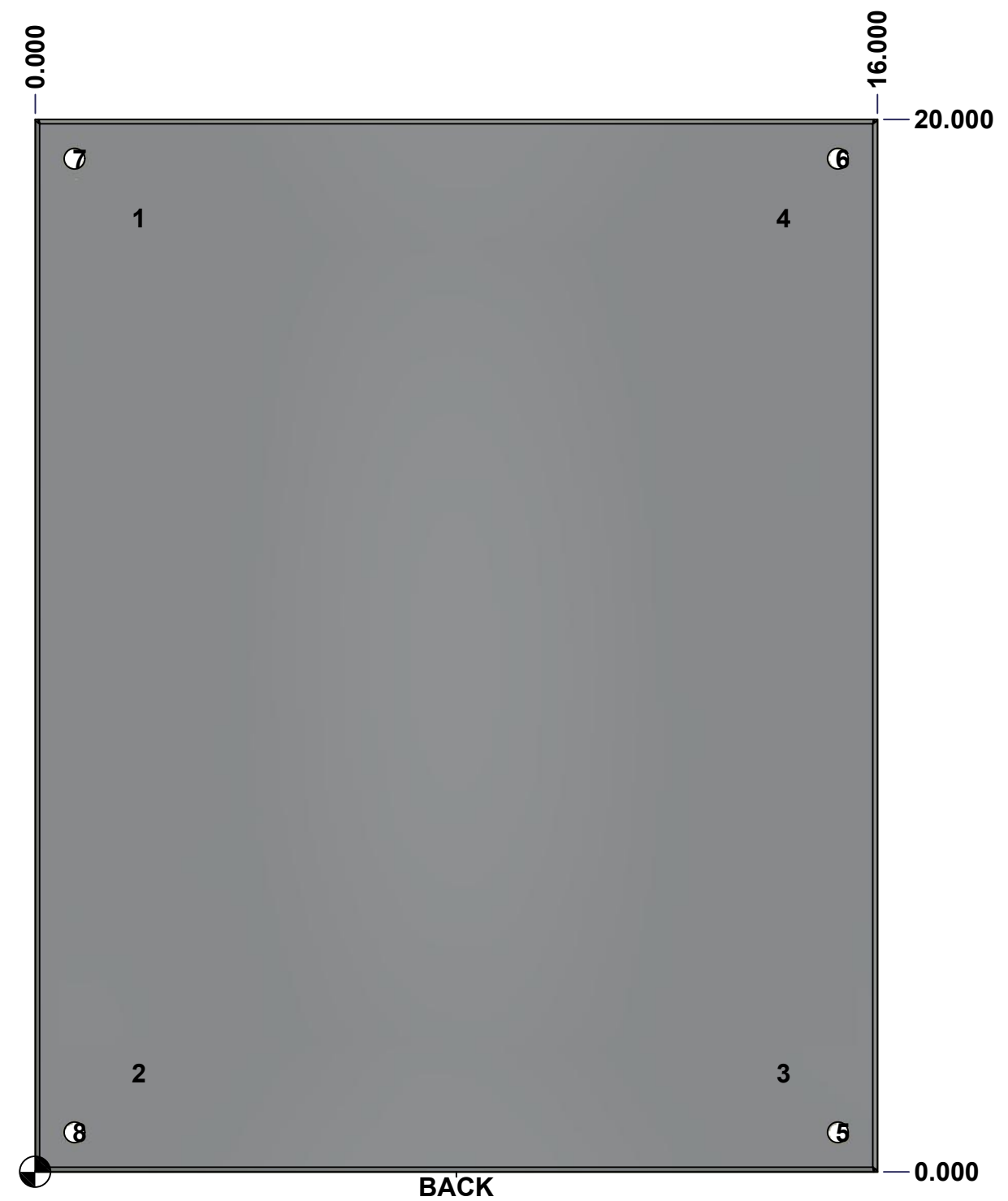

	Description	Status	
	1100W 20" x 16" x 8.87" Body	(NULL)	
	Part Number Numéro Pièce	Rev.	
	1100W201608B	0	4 8

This drawing is confidential and must not be reproduced or used without the consent of EXM

Ce dessin est confidentiel et ne doit pas être reproduit ou utilisé sans le consentement de EXM

No.	Revisions	Date	By/Par

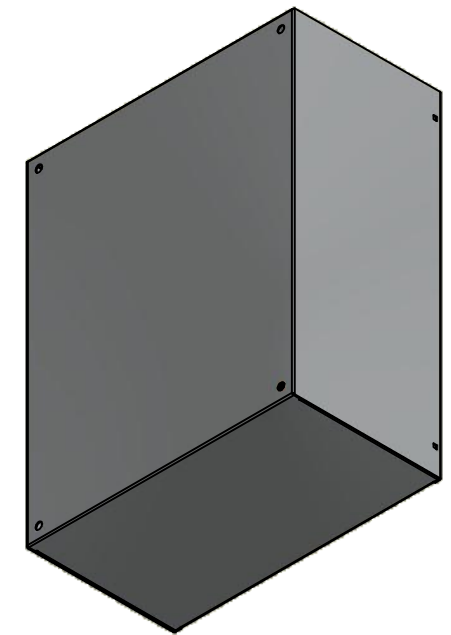

Isometric View



Tél: (450) 979-4373
 Fax: (450) 979-4626
www.exmweb.com

Flatness
Aplatissement

Max 3.0mm

Projection

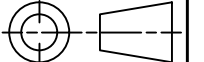

Customer Client	Date
Drawn By / Dessiné Par: BoxCad: BoxCad	Date: 27-Dec-13
Material / Matière: 16 Ga Cold Rolled A1008 CS Type B (1.4mm)	

Color / Couleur: Asa-61 Grey	Finish / Fini: Smooth
------------------------------	-----------------------

Description: 1100W 20" x 16" x 8.87" Body	Detail Rev.
---	-------------

Part Number / Numéro Pièce: 1100W201608B	Rev. 0	5 / 8
---	--------	-------

Qty	Part Number	Rev	Description
1	STK-P-02400S	0	Powder Paint (Asa-61 Grey / Smooth)
1	STK-S-00100	0	3.5" x 2" Silver Milar Flexcon Sticker
2	STK-Q-77110	1	5412 ES Cover Plastic Plug
1	STK-Q-16080	0	Ground Stud M6 x 16mm
4	STK-Q-16005	1	Stud M8 x 35 (No Paint Cap Required)
1	1100W201608B-P	0	1100W 20" x 16" x 8.87" Body Part
Parts List			

This drawing is confidential and must not be reproduced or used without the consent of EXM

Ce dessin est confidentiel et ne doit pas être reproduit ou utilisé sans le consentement de EXM



TOP

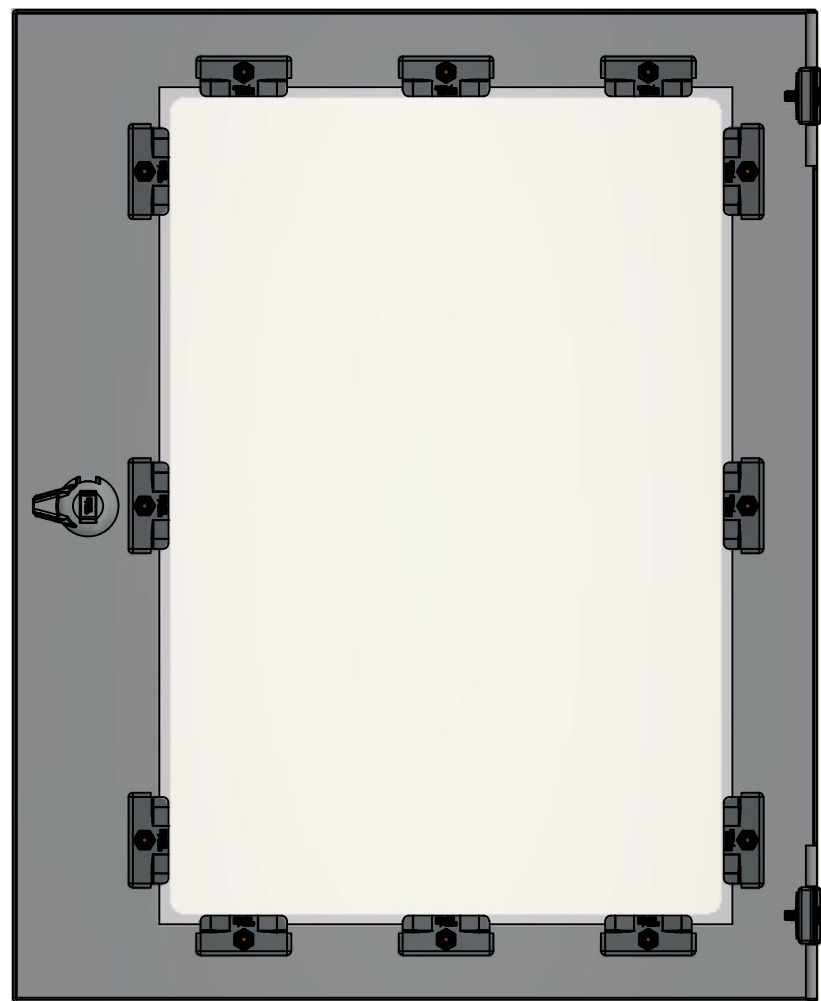

BACK



BOTTOM

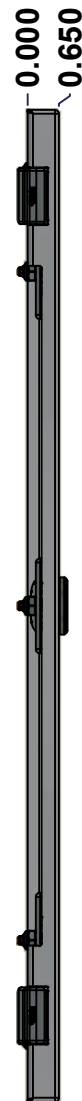

LEFT

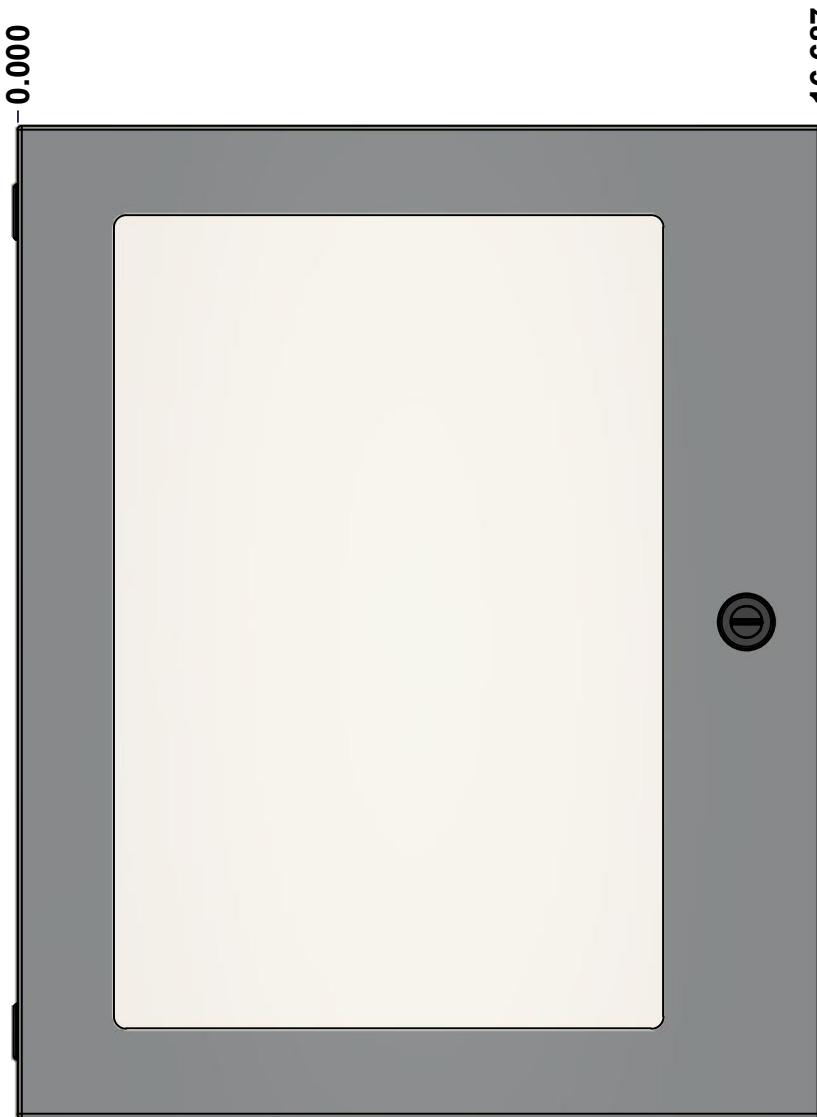

FRONT

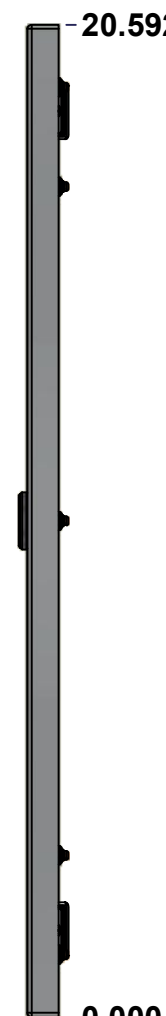

RIGHT

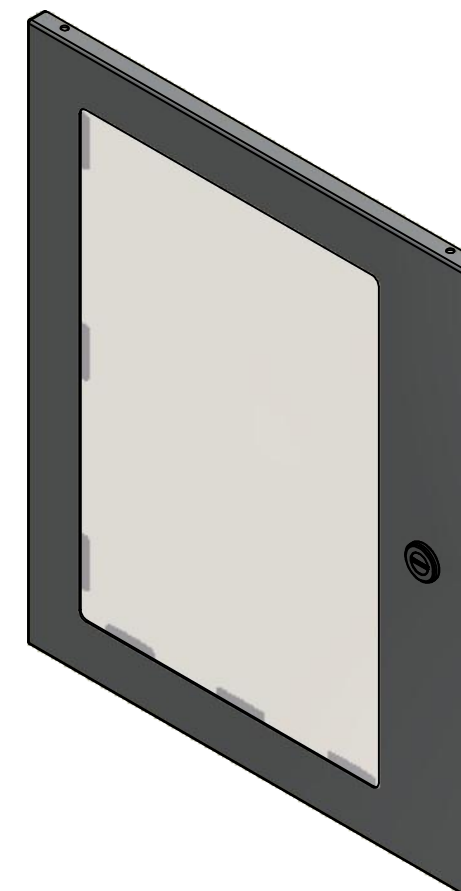

Isometric View



No.	Revisions	Date	By/Par

Tél: (450) 979-4373 Fax: (450) 979-4626 www.exmweb.com		Flatness Aplatissement	
		Max 3.0mm	
Customer Client		Date	
Drawn By Dessiné Par BoxCad: BoxCad		Date 27-Dec-13	
Material Matière 16 Ga Cold Rolled A1008 CS Type B (1.4mm)			
Color Couleur Asa-61 Grey		Finish Fini Smooth	
Description 1100W 20" x 16" Cover			Detail Rev.
Part Number Numéro Pièce 1100W201608C		Rev. 0	6 8

SEE BILL OF MATERIAL ON LAST PAGE

This drawing is confidential and must not be reproduced or used without the consent of EXM

Ce dessin est confidentiel et ne doit pas être reproduit ou utilisé sans le consentement de EXM

STANDARD FEATURES ARE NOT LISTED IN THIS HOLE TABLE			
HOLE TABLE - FRONT VIEW (CUSTOM FEATURE ONLY)			
CUT-OUT	XDIM	YDIM	DESCRIPTION
1	15.125	10.296	LOCK 880 SCQ1-SLZ @ 0.0°

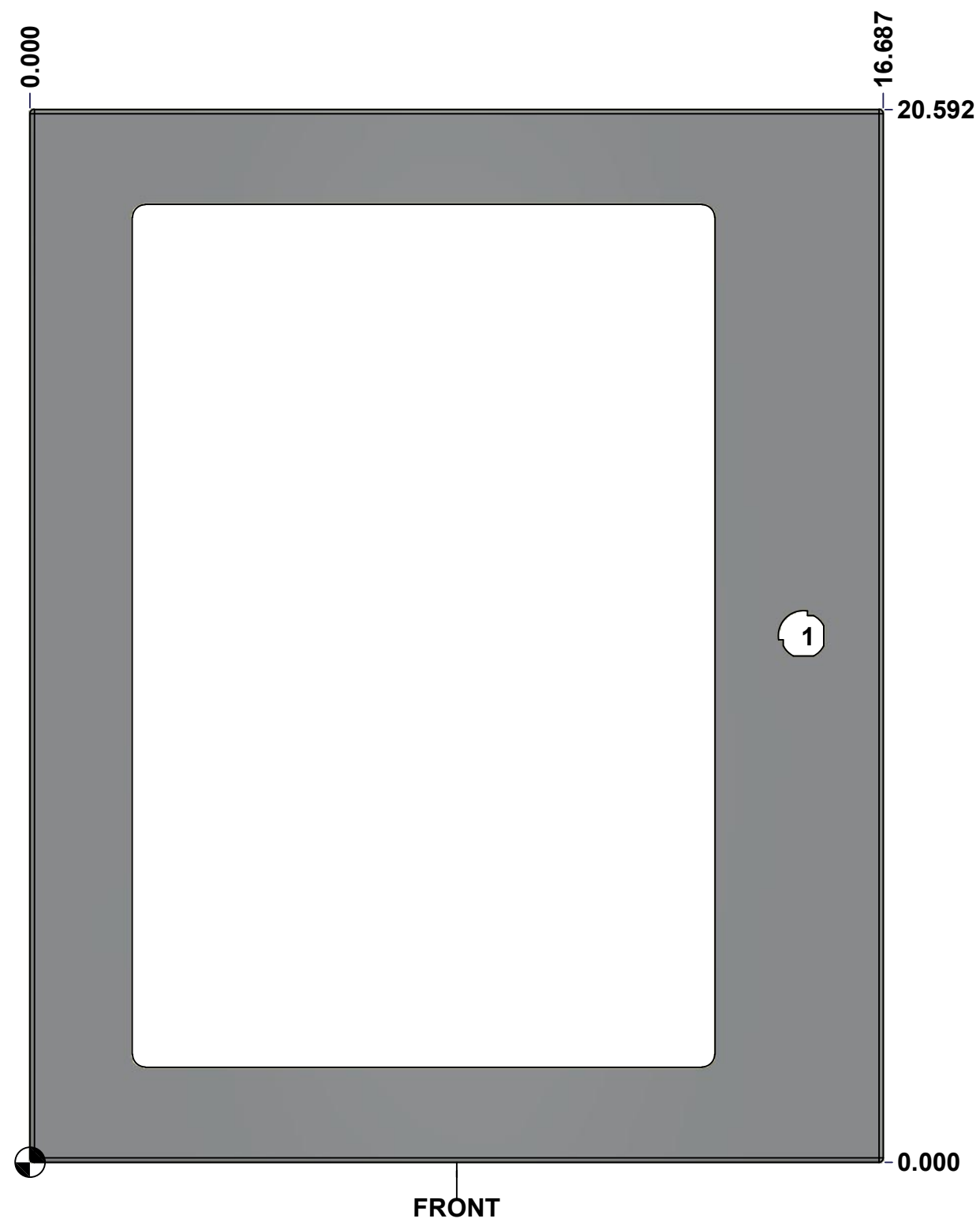

	Description	Status	
	1100W 20" x 16" x 8.87" Cover	(NULL)	
	Part Number Numéro Pièce	Rev.	
	1100W201608C	0	7 8

This drawing is confidential and must not be reproduced or used without the consent of EXM

Ce dessin est confidentiel et ne doit pas être reproduit ou utilisé sans le consentement de EXM

No.	Revisions	Date	By/Par

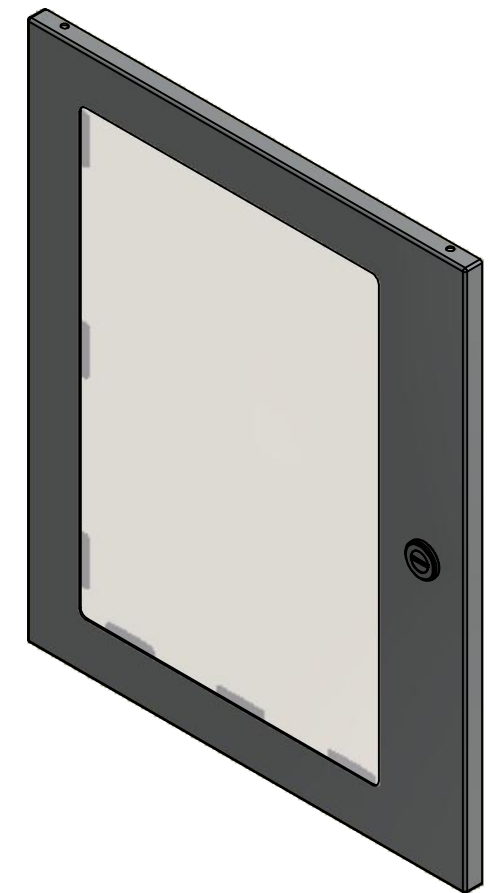

Isometric View

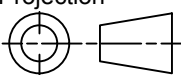

 Tél: (450) 979-4373 Fax: (450) 979-4626 www.exmweb.com		Flatness Aplatissement Max 3.0mm Projection 
Customer Client	Date	
Drawn By Dessiné Par	BoxCad: BoxCad	Date 27-Dec-13
Material Matière	16 Ga Cold Rolled A1008 CS Type B (1.4mm)	
Color Couleur	Asa-61 Grey	Finish Fini Smooth
Description		Detail Rev.
1100W 20" x 16" Cover		
Part Number Numéro Pièce	Rev.	8
1100W201608C	0	8

Qty	Part Number	Rev	Description
1	880 SCQ1-SLZ	0	1100 1/4 Turn Lock
12	STK-Q-60702	1	880 WK - Lexan 1/4" Fixing Bracket
12	STK-Q-16055	1	M6 x 18mm Stud (No Paint Cap Required)
1	1100W201608LX	0	1100W 20" x 16" x 8.87" Lexan
1	STK-P-02400S	0	Powder Paint (Asa-61 Grey / Smooth)
1	1100W201608C-P	0	1100W 20" x 16" x 8.87" Cover Part
2	STK-A-33033	4	5412 ESMCH Hinge
Parts List			