

This drawing is confidential and must not be reproduced or used without the consent of EXM

Ce dessin est confidentiel et ne doit pas être reproduit ou utilisé sans le consentement de EXM

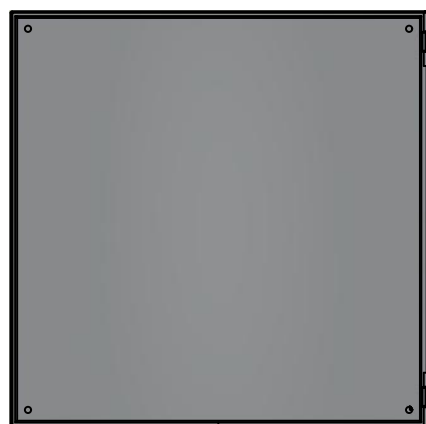

TOP



BACK

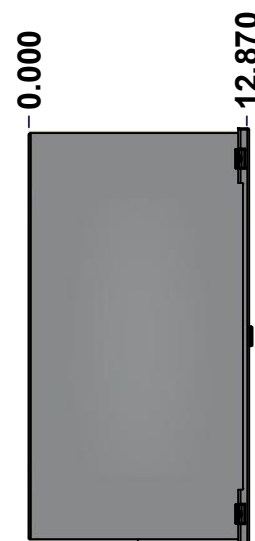

LEFT

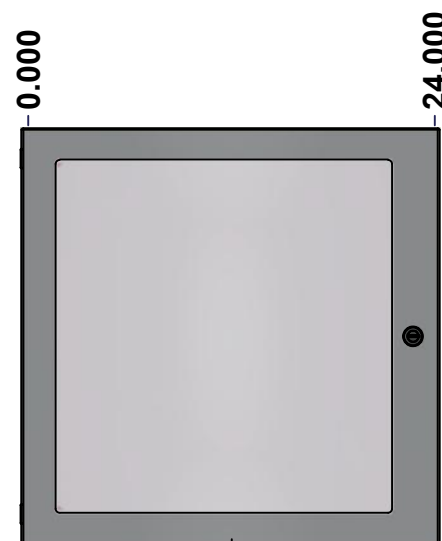

FRONT

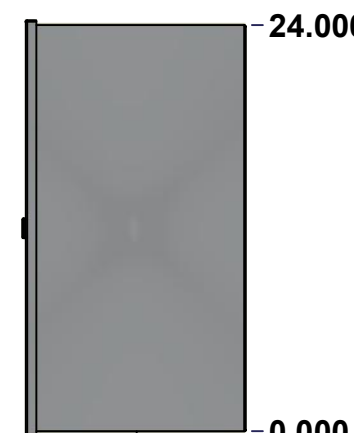

RIGHT



BOTTOM

No.	Revisions	Date	By/Par

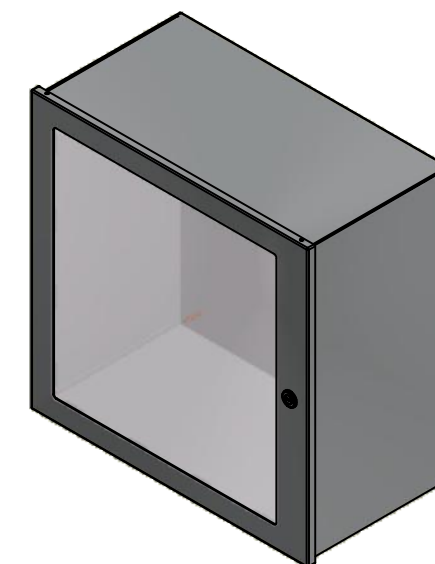

Isometric View



Tél: (450) 979-4373  
 Fax: (450) 979-4626  
[www.exmweb.com](http://www.exmweb.com)

Flatness  
Aplatissement

Max 3.0mm

Projection



Customer Client	Date
Drawn By / Dessiné Par: BoxCad: BoxCad	Date: 31-Dec-13
Material / Matière: 14 Ga Cold Rolled A1008 CS Type B (1.7mm)	
Color / Couleur: Asa-61 Grey	Finish / Fini: Smooth

Description: 1100W 24" x 24" x 12.87" Assembly	Detail Rev.
--	-------------

Part Number / Numéro Pièce: 1100W242412	Rev. 0	1	8
---	--------	---	---

SEE BILL OF MATERIAL ON LAST PAGE

This drawing is confidential and must not be reproduced or used without the consent of EXM

Ce dessin est confidentiel et ne doit pas être reproduit ou utilisé sans le consentement de EXM

NOTE	
ITEM	DESCRIPTION
1	NEMA 1 Enclosure
2	C/W Standard ground studs on box and cover
3	W/O Standard door stiffener
4	W/O Inner panel
5	C/W Standard inner panel mounting studs

No.	Revisions	Date	By/Par

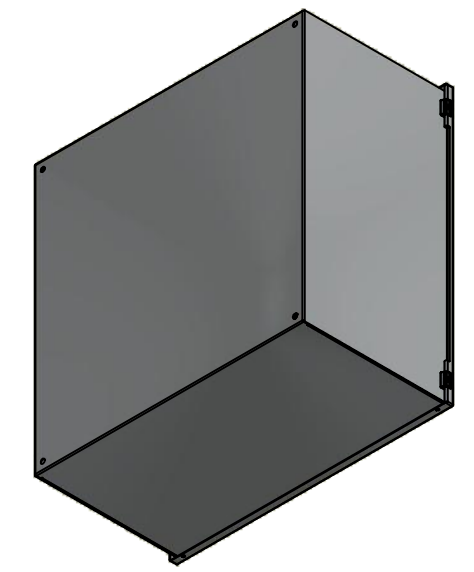

Isometric View

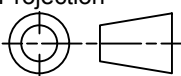
 Tél: (450) 979-4373 Fax: (450) 979-4626 <a href="http://www.exmweb.com">www.exmweb.com</a>	Flatness Aplatissement
	Max 3.0mm
Projection	
Customer Client	Date
Drawn By Dessiné Par BoxCad: BoxCad	Date 31-Dec-13
Material Matière 14 Ga Cold Rolled A1008 CS Type B (1.7mm)	
Color Couleur Asa-61 Grey	Finish Fini Smooth

PACKING		
ITEM	QTY	DESCRIPTION
Cardboard sleeve	1	Top
Thermal plastic film	1	Use with Packing Tunnel Wrapper Machine
Packaging label	1	White label with product number

1	1100W242412B	0	1100W 24" x 24" x 12.87" Body
1	1100W242412C	0	1100W 24" x 24" Cover
2	STK-Q-08100	1	M5 Nylon Insert Lock Nut
Qty	Part Number	Rev	Description
Parts List			

Description	Detail Rev.
1100W 24" x 24" x 12.87" Assembly	
Part Number Numéro Pièce	Rev.
<b>1100W242412</b>	<b>0</b>
	2
	8

This drawing is confidential and must not be reproduced or used without the consent of EXM

Ce dessin est confidentiel et ne doit pas être reproduit ou utilisé sans le consentement de EXM



TOP

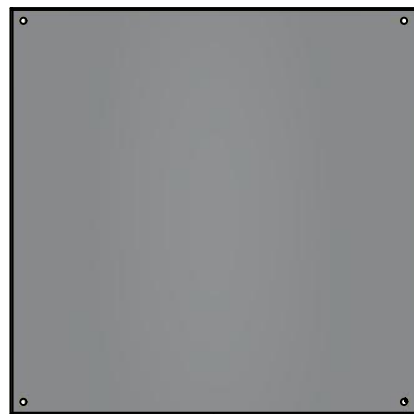

BACK

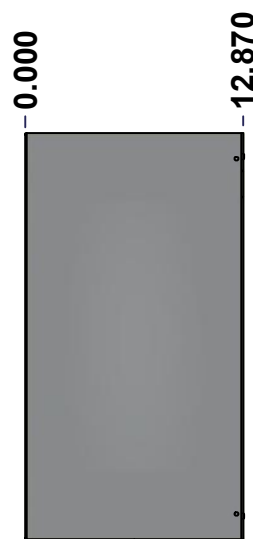

LEFT

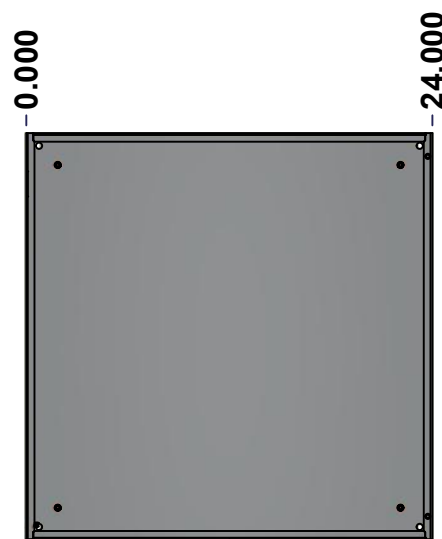

FRONT

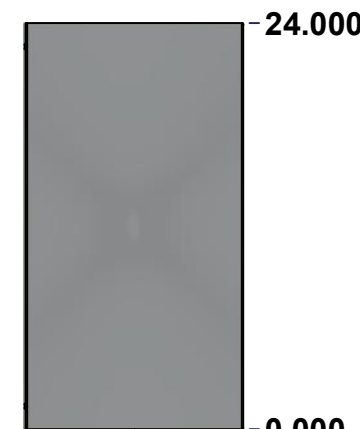

RIGHT



BOTTOM

No.	Revisions	Date	By/Par

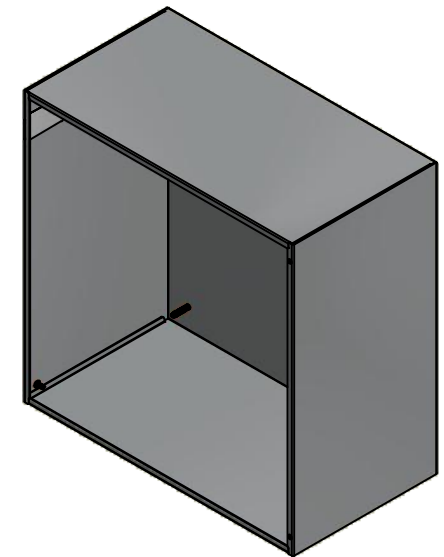

Isometric View



Tél: (450) 979-4373  
 Fax: (450) 979-4626  
[www.exmweb.com](http://www.exmweb.com)

Flatness  
Aplatissement

Max 3.0mm

Projection

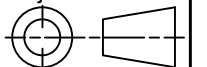

Customer Client	Date
Drawn By / Dessiné Par: BoxCad: BoxCad	Date: 31-Dec-13
Material / Matière: 14 Ga Cold Rolled A1008 CS Type B (1.7mm)	
Color / Couleur: Asa-61 Grey	Finish / Fini: Smooth
Description: 1100W 24" x 24" x 12.87" Body	Detail Rev.
Part Number / Numéro Pièce: 1100W242412B	Rev. 3
	0

SEE BILL OF MATERIAL ON LAST PAGE

This drawing is confidential and must not be reproduced or used without the consent of EXM

Ce dessin est confidentiel et ne doit pas être reproduit ou utilisé sans le consentement de EXM

**STANDARD FEATURES ARE NOT LISTED IN THIS HOLE TABLE**

**HOLE TABLE - BACK VIEW (CUSTOM FEATURE ONLY)**

CUT-OUT	XDIM	YDIM	DESCRIPTION
1	1.875	22.125	IP STUD M8 x 35mm (Inside)
2	1.875	1.875	IP STUD M8 x 35mm (Inside)
3	22.125	1.875	IP STUD M8 x 35mm (Inside)
4	22.125	22.125	IP STUD M8 x 35mm (Inside)
-----			
5	23.250	0.750	RND Ø0.390
6	23.250	23.250	RND Ø0.390
7	0.750	23.250	RND Ø0.390
8	0.750	0.750	RND Ø0.390

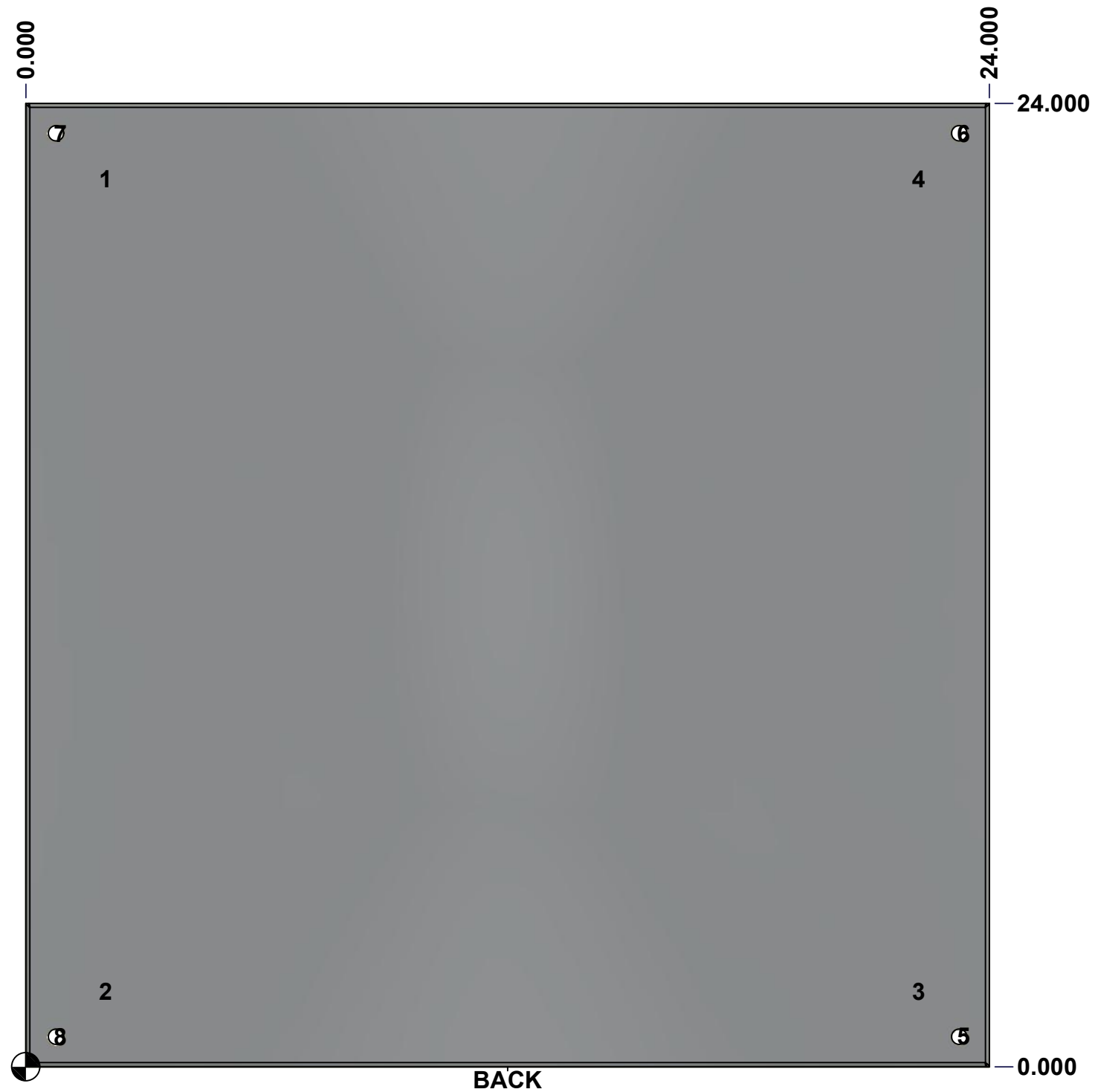

	Description 1100W 24" x 24" x 12.87" Body	Status (NULL)
	Part Number Numéro Pièce <b>1100W242412B</b>	Rev. 4 <b>0</b> / 8

This drawing is confidential and must not be reproduced or used without the consent of EXM

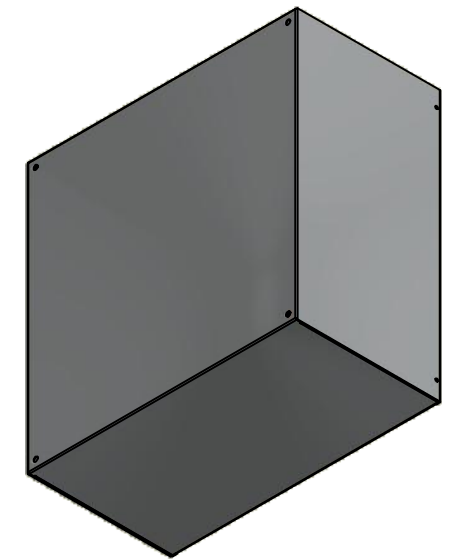

Ce dessin est confidentiel et ne doit pas être reproduit ou utilisé sans le consentement de EXM

No.	Revisions	Date	By/Par



Isometric View



 Tél: (450) 979-4373 Fax: (450) 979-4626 <a href="http://www.exmweb.com">www.exmweb.com</a>		Flatness Aplatissement  Max 3.0mm
Customer Client		Date
Drawn By Dessiné Par BoxCad: BoxCad		Date 31-Dec-13
Material Matière 14 Ga Cold Rolled A1008 CS Type B (1.7mm)		
Color Couleur Asa-61 Grey		Finish Fini Smooth
Description 1100W 24" x 24" x 12.87" Body		Detail Rev.
Part Number Numéro Pièce <b>1100W242412B</b>		Rev. 5 <b>0</b>

Qty	Part Number	Rev	Description
1	STK-P-02400S	0	Powder Paint (Asa-61 Grey / Smooth)
1	STK-S-00100	0	3.5" x 2" Silver Milar Flexcon Sticker
2	STK-Q-77110	1	5412 ES Cover Plastic Plug
1	STK-Q-16080	0	Ground Stud M6 x 16mm
4	STK-Q-16005	1	Stud M8 x 35 (No Paint Cap Required)
1	1100W242412B-P	0	1100W 24" x 24" x 12.87" Body Part
Parts List			

This drawing is confidential and must not be reproduced or used without the consent of EXM

Ce dessin est confidentiel et ne doit pas être reproduit ou utilisé sans le consentement de EXM



TOP

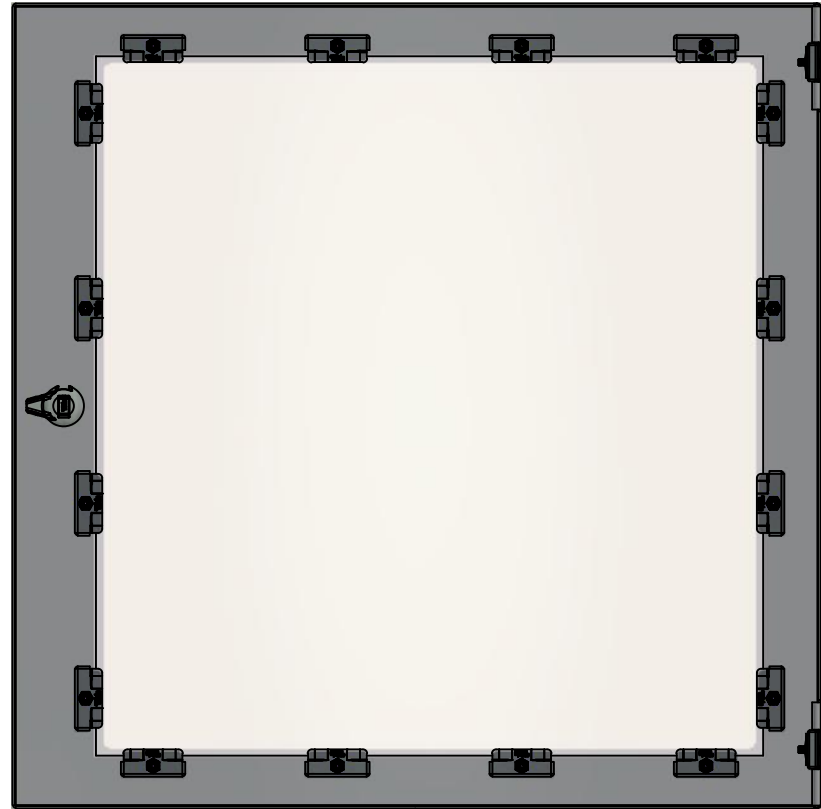

BACK



BOTTOM

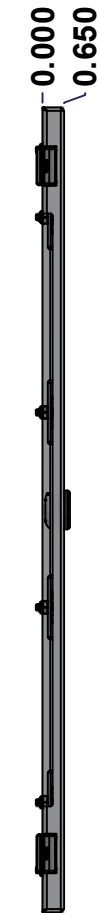

LEFT

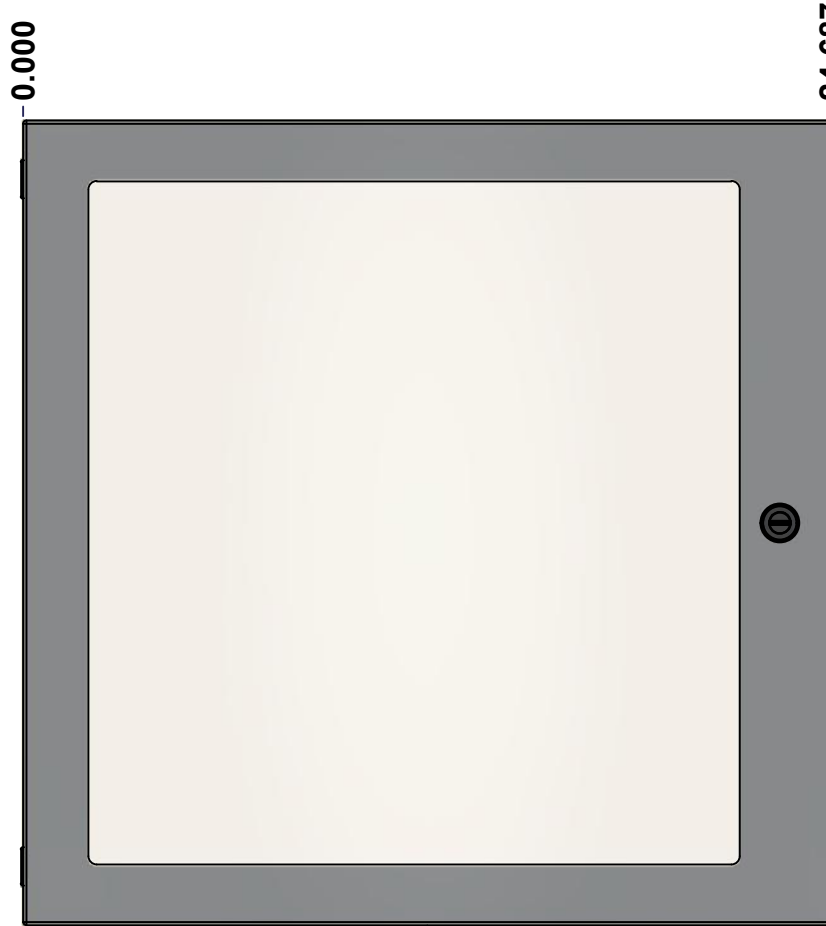

FRONT

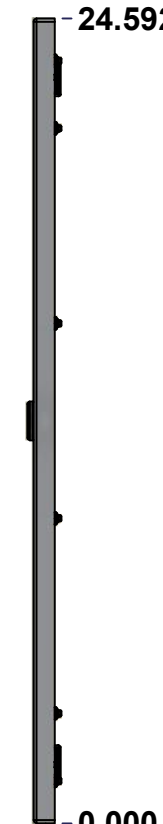

RIGHT

No.	Revisions	Date	By/Par

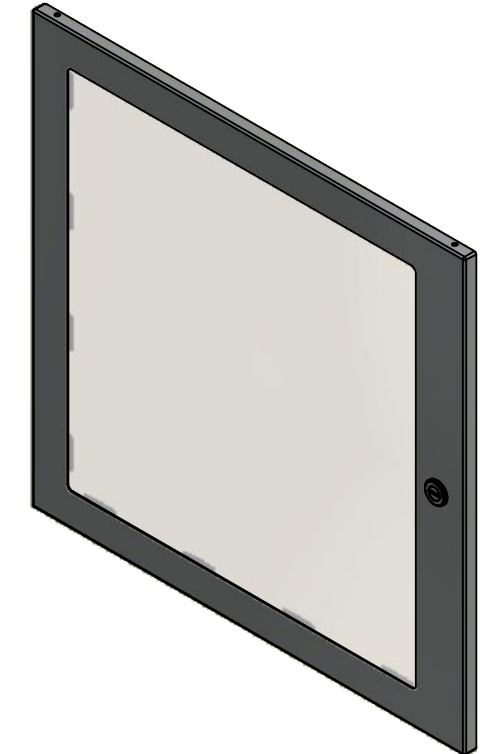

Isometric View

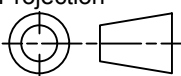

 Tél: (450) 979-4373 Fax: (450) 979-4626 <a href="http://www.exmweb.com">www.exmweb.com</a>		Flatness Aplatissement Max 3.0mm Projection 
Customer Client	Date	
Drawn By Dessiné Par	BoxCad: BoxCad	Date 31-Dec-13
Material Matière	16 Ga Cold Rolled A1008 CS Type B (1.4mm)	
Color Couleur	Asa-61 Grey	Finish Fini Smooth
Description 1100W 24" x 24" Cover		Detail Rev.
Part Number Numéro Pièce	1100W242412C	Rev. 6 0

SEE BILL OF MATERIAL ON LAST PAGE

This drawing is confidential and must not be reproduced or used without the consent of EXM

Ce dessin est confidentiel et ne doit pas être reproduit ou utilisé sans le consentement de EXM

<b>STANDARD FEATURES ARE NOT LISTED IN THIS HOLE TABLE</b>			
<b>HOLE TABLE - FRONT VIEW (CUSTOM FEATURE ONLY)</b>			
CUT-OUT	XDIM	YDIM	DESCRIPTION
1	23.125	12.296	LOCK 880 SCQ1-SLZ @ 0.0°

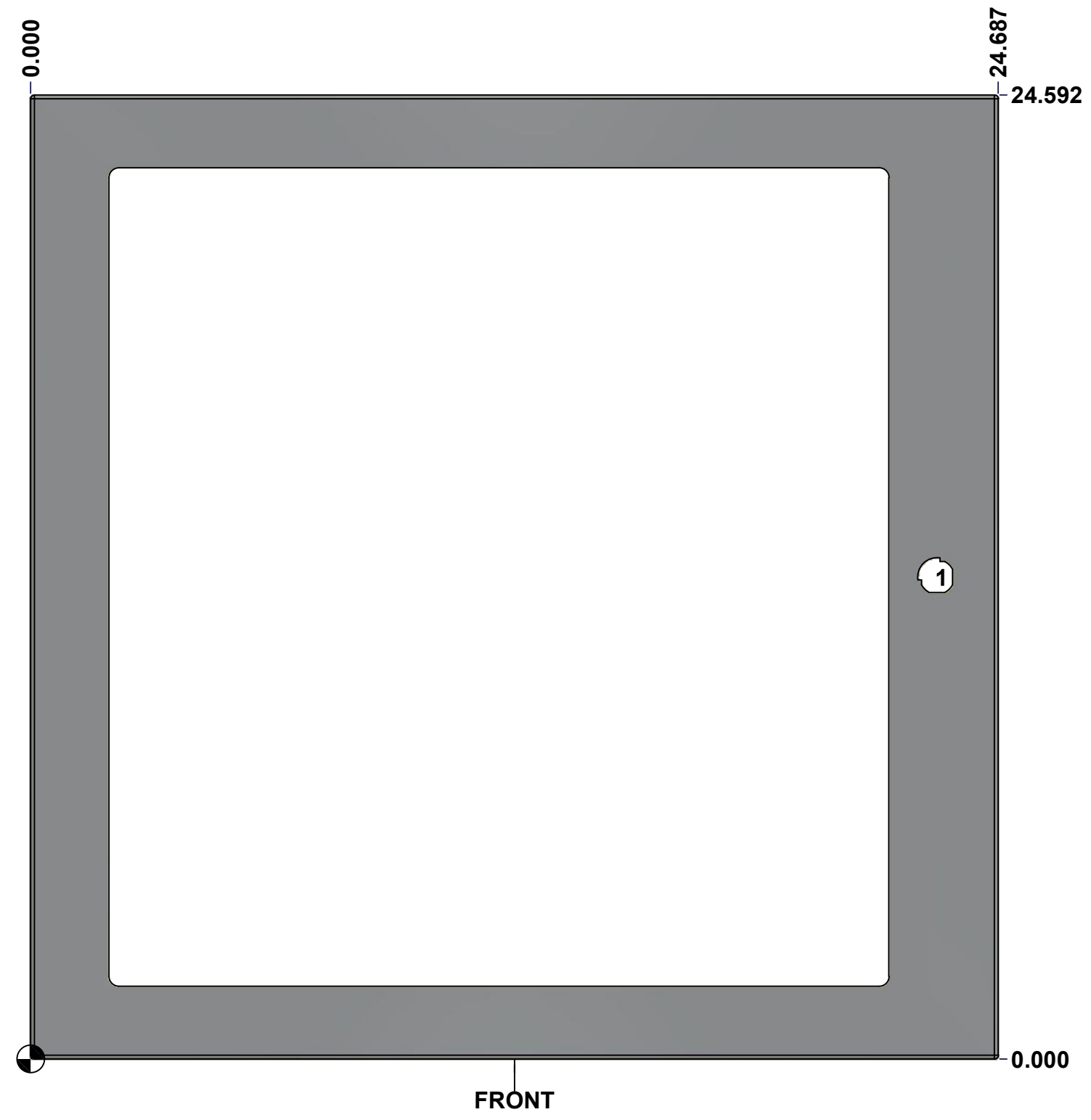

	Description	Status	
	1100W 24" x 24" x 12.87" Cover	(NULL)	
	Part Number Numéro Pièce	Rev.	
	<b>1100W242412C</b>	<b>0</b>	7 8

This drawing is confidential and must not be reproduced or used without the consent of EXM

Ce dessin est confidentiel et ne doit pas être reproduit ou utilisé sans le consentement de EXM

No.	Revisions	Date	By/Par

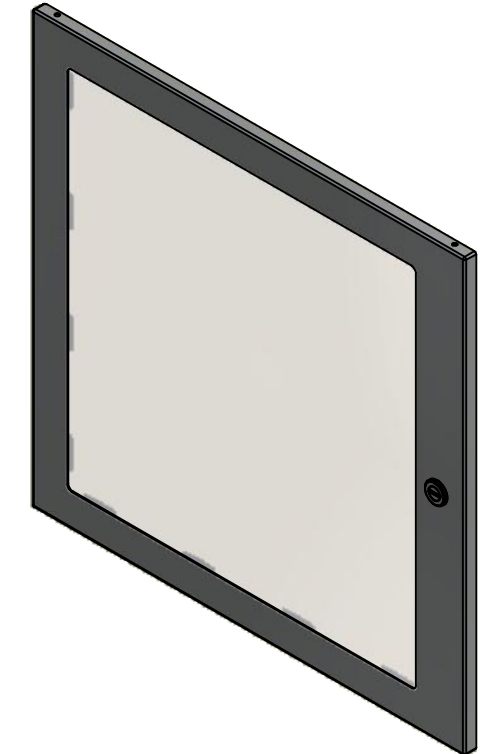

Isometric View

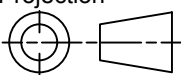
 Tél: (450) 979-4373 Fax: (450) 979-4626 <a href="http://www.exmweb.com">www.exmweb.com</a>	Flatness Aplatissement	Max 3.0mm
	Projection	
Customer Client	Date	
Drawn By Dessiné Par	BoxCad: BoxCad	Date 31-Dec-13
Material Matière	16 Ga Cold Rolled A1008 CS Type B (1.4mm)	
Color Couleur	Asa-61 Grey	Finish Fini Smooth
Description	Detail Rev.	
1100W 24" x 24" Cover		
Part Number Numéro Pièce	Rev.	8
<b>1100W242412C</b>	<b>0</b>	<b>8</b>

Qty	Part Number	Rev	Description
1	880 SCQ1-SLZ	0	1100 1/4 Turn Lock
16	STK-Q-60702	1	880 WK - Lexan 1/4" Fixing Bracket
16	STK-Q-16055	1	M6 x 18mm Stud (No Paint Cap Required)
1	1100W242412LX	0	1100W 24" x 24" x 12.87" Lexan
1	STK-P-02400S	0	Powder Paint (Asa-61 Grey / Smooth)
1	1100W242412C-P	0	1100W 24" x 24" x 12.87" Cover Part
2	STK-A-33033	4	5412 ESMCH Hinge
Parts List			