

This drawing is confidential and must not be reproduced or used without the consent of EXM

Ce dessin est confidentiel et ne doit pas être reproduit ou utilisé sans le consentement de EXM

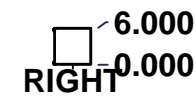
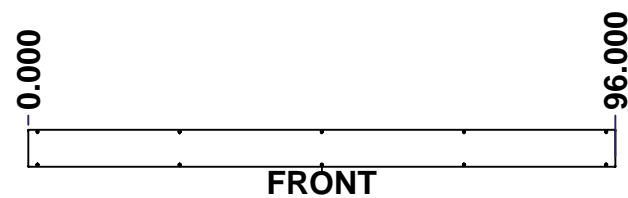
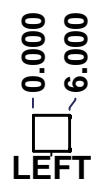

No.	Revisions	Date	By/Par

**Isometric View**

<p>Tél: (450) 979-4373                  Fax: (450) 979-4626  <a href="http://www.exmweb.com">www.exmweb.com</a></p>		Flatness Aplatissement
		Max 3.0mm
Customer Client		Date
Drawn By Dessiné Par BoxCad: BoxCad		Date 13-Apr-15
Material Matière 16 Ga Cold Rolled A1008 CS Type B (1.4mm)		
Color Couleur Asa-61 Grey	Finish Fini Smooth	
Description 1100WDN 6" x 6" x 96" Assembly		Detail Rev.
Part Number Numéro Pièce <b>1100WD060696N</b>		Rev. <b>0</b>

**SEE BILL OF MATERIAL ON LAST PAGE**

1
2

This drawing is confidential and must not be reproduced or used without the consent of EXM

Ce dessin est confidentiel et ne doit pas être reproduit ou utilisé sans le consentement de EXM

NOTE	
ITEM	DESCRIPTION
1	NEMA 1 Enclosure
2	C/W Standard ground provision on box and cover
3	W/O Standard door stiffener
4	W/O Inner panel
5	W/O Inner panel mounting provision

No.	Revisions	Date	By/Par

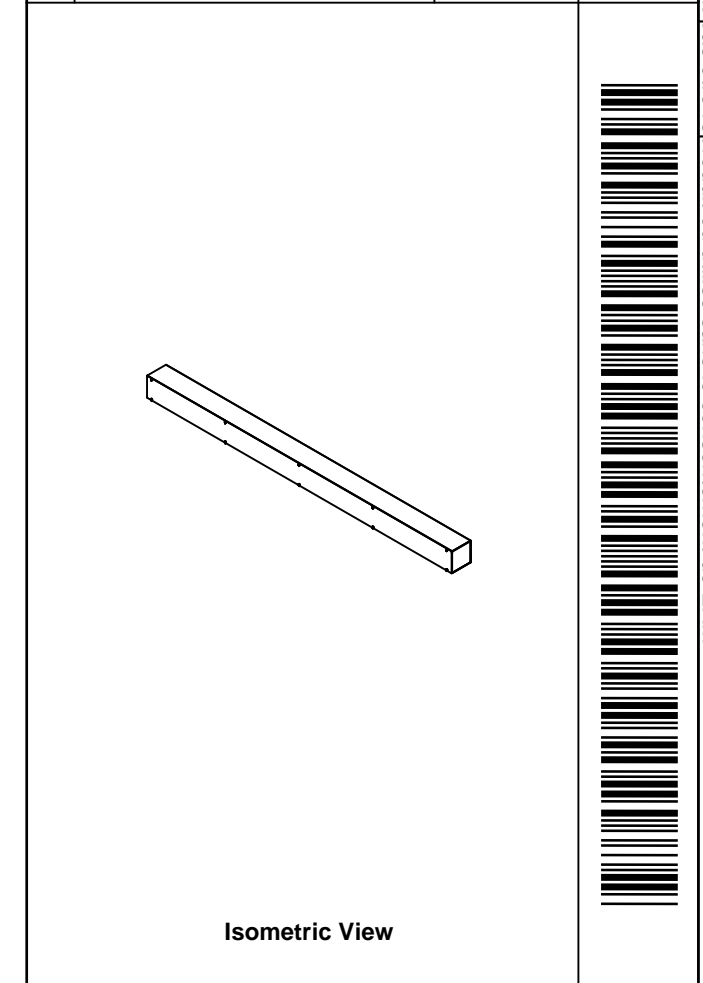

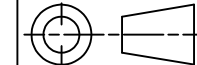
 Tél: (450) 979-4373 Fax: (450) 979-4626 <a href="http://www.exmweb.com">www.exmweb.com</a>		Flatness Aplatissement Max 3.0mm Projection 
Customer Client	Date	
Drawn By Dessiné Par	BoxCad: BoxCad	Date 13-Apr-15
Material Matière	16 Ga Cold Rolled A1008 CS Type B (1.4mm)	
Color Couleur	Asa-61 Grey	Finish Fini Smooth
Description	Detail Rev.	
1100WDN 6" x 6" x 96" Assembly		
Part Number Numéro Pièce	Rev.	2
1100WD060696N		0

PACKING		
ITEM	QTY	DESCRIPTION
Thermal plastic film	1	Use with Packing Tunnel Wrapper Machine
Packaging label	1	White label with product number

Qty	Part Number	Rev	Description
10	STK-Q-05020	5	M5 x 8mm Thread Rolling Screw
1	1100WD060696NC	0	1100WDN 6" x 96" Cover
1	1100WD060696NB	0	1100WDN 6" x 6" x 96" Body
Parts List			

This drawing is confidential and must not be reproduced or used without the consent of EXM

Ce dessin est confidentiel et ne doit pas être reproduit ou utilisé sans le consentement de EXM



TOP

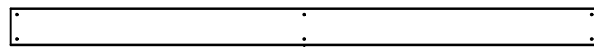

BACK

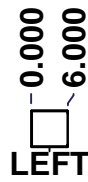

LEFT



FRONT

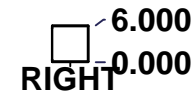

RIGHT

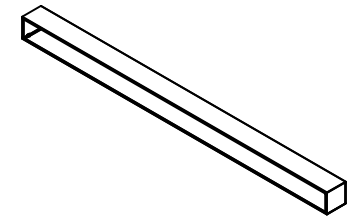

Isometric View

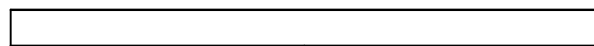

BOTTOM



Tél: (450) 979-4373  
Fax: (450) 979-4626  
[www.exmweb.com](http://www.exmweb.com)

Flatness  
Aplatissement

Max 3.0mm

Projection

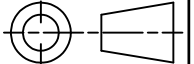

Customer Client	Date
Drawn By Dessiné Par BoxCad: BoxCad	Date 13-Apr-15
Material Matière 16 Ga Cold Rolled A1008 CS Type B (1.4mm)	
Color Couleur Asa-61 Grey	Finish Fini Smooth
Description 1100WDN 6" x 6" x 96" Body	Detail Rev.
Part Number Numéro Pièce <b>1100WD060696NB</b>	Rev. <b>0</b>

SEE BILL OF MATERIAL ON LAST PAGE

1  
7

This drawing is confidential and must not be reproduced or used without the consent of EXM

Ce dessin est confidentiel et ne doit pas être reproduit ou utilisé sans le consentement de EXM

STANDARD FEATURES ARE NOT LISTED IN THIS HOLE TABLE			
HOLE TABLE - BACK VIEW (CUSTOM FEATURE ONLY)			
CUT-OUT	XDIM	YDIM	DESCRIPTION
1	48.000	5.000	RND Ø0.290
2	48.000	1.000	RND Ø0.290
3	95.000	1.000	RND Ø0.290
4	95.000	5.000	RND Ø0.290
5	1.000	5.000	RND Ø0.290
6	1.000	1.000	RND Ø0.290

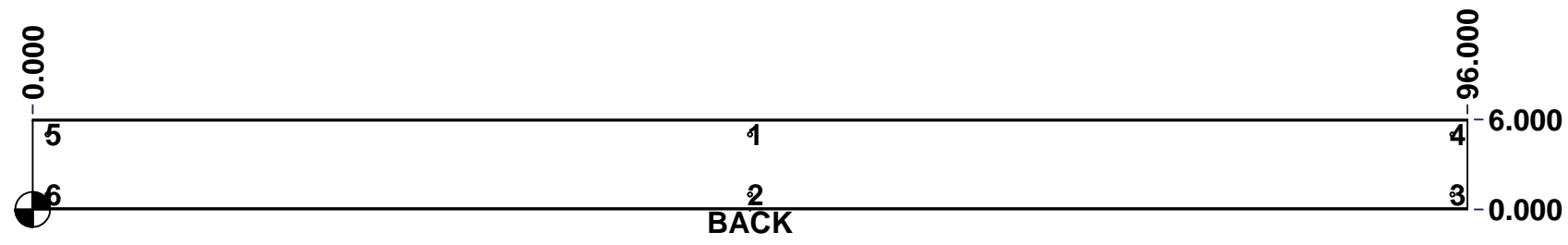



	Description	Status	
	1100WDN 6" x 6" x 96" Body	(NULL)	
	Part Number Numéro Pièce	Rev.	
	<b>1100WD060696NB</b>	<b>0</b>	6 / 7

This drawing is confidential and must not be reproduced or used without the consent of EXM

Ce dessin est confidentiel et ne doit pas être reproduit ou utilisé sans le consentement de EXM

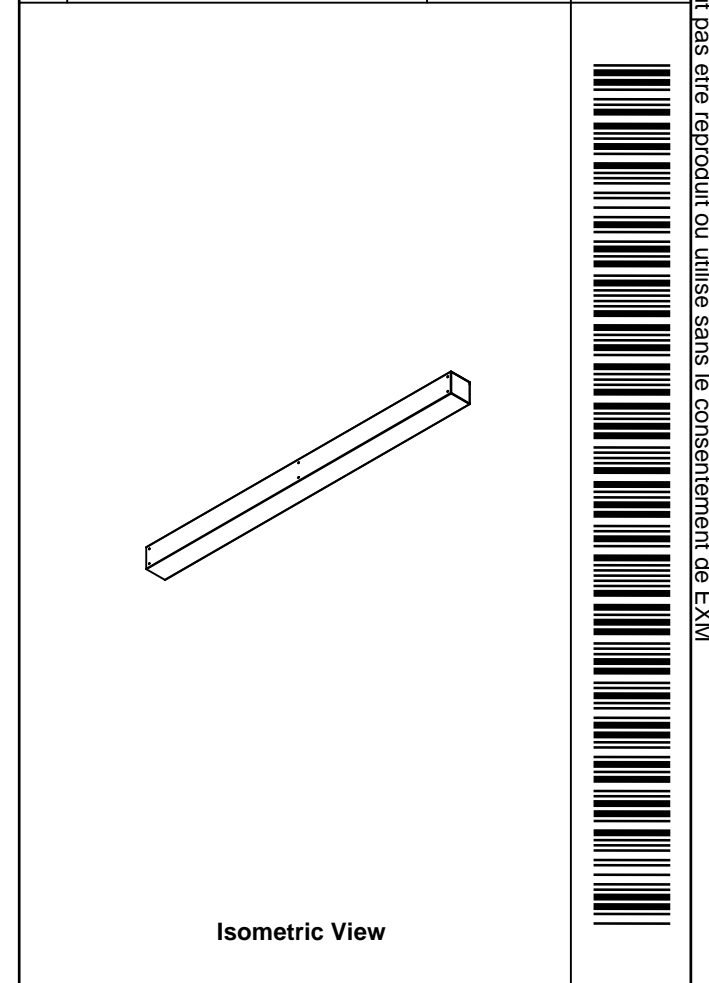
No.	Revisions	Date	By/Par

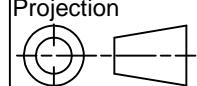

 Tél: (450) 979-4373 Fax: (450) 979-4626 <a href="http://www.exmweb.com">www.exmweb.com</a>		Flatness Aplatissement Max 3.0mm Projection 
Customer Client	Date	
Drawn By Dessiné Par	BoxCad: BoxCad	Date 13-Apr-15
Material Matière	16 Ga Cold Rolled A1008 CS Type B (1.4mm)	
Color Couleur	Asa-61 Grey	Finish Fini Smooth
Description		Detail Rev.
1100WDN 6" x 6" x 96" Body		
Part Number Numéro Pièce	Rev.	7
<b>1100WD060696NB</b>	<b>0</b>	7

Qty	Part Number	Rev	Description
1	1100WD060696NR-P	0	1100WDN 6" x 6" Right Part
1	1100WD060696NL-P	0	1100WDN 6" x 6" Left Part
1	1100WD060696NB-P	0	1100WDN 6" x 6" x 96" Body Part
1	STK-P-02400S	0	Powder Paint (Asa-61 Grey / Smooth)
Parts List			

This drawing is confidential and must not be reproduced or used without the consent of EXM

Ce dessin est confidentiel et ne doit pas être reproduit ou utilisé sans le consentement de EXM

TOP

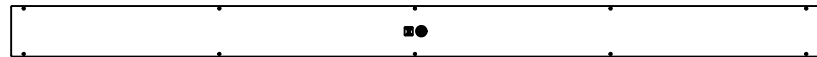

BACK

LEFT



FRONT

RIGHT

BOTTOM

No.	Revisions	Date	By/Par

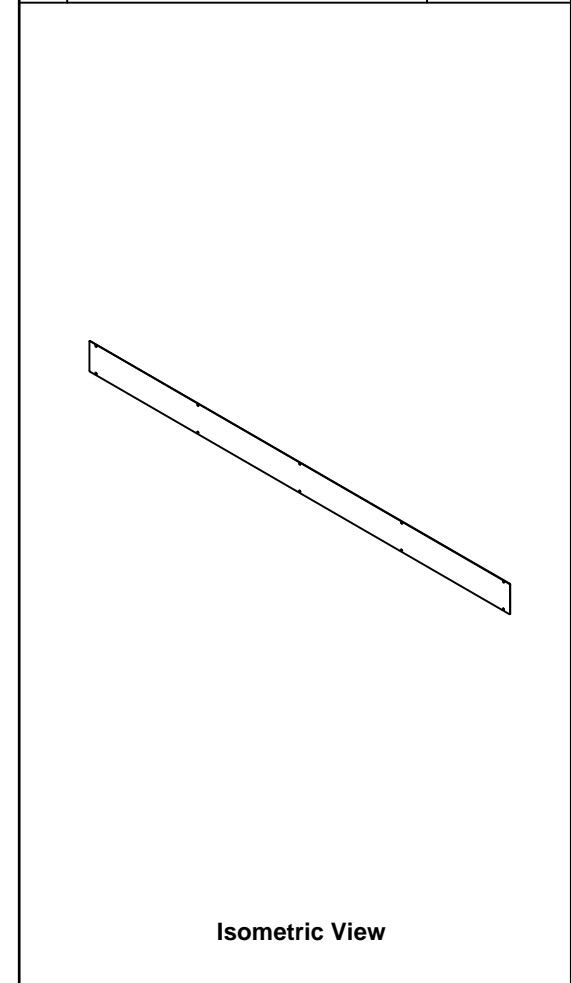

Isometric View

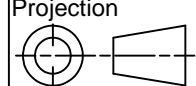

 Tél: (450) 979-4373 Fax: (450) 979-4626 <a href="http://www.exmweb.com">www.exmweb.com</a>		Flatness Aplatissement Max 3.0mm Projection 
Customer Client	Date	
Drawn By Dessiné Par	BoxCad: BoxCad	Date 13-Apr-15
Material Matière	16 Ga Cold Rolled A1008 CS Type B (1.4mm)	
Color Couleur	Asa-61 Grey	Finish Fini Smooth
Description 1100WDN 6" x 96" Cover		Detail Rev.
Part Number Numéro Pièce	1100WD060696NC	Rev. 0

SEE BILL OF MATERIAL ON LAST PAGE

3

This drawing is confidential and must not be reproduced or used without the consent of EXM

Ce dessin est confidentiel et ne doit pas être reproduit ou utilisé sans le consentement de EXM

No.	Revisions	Date	By/Par

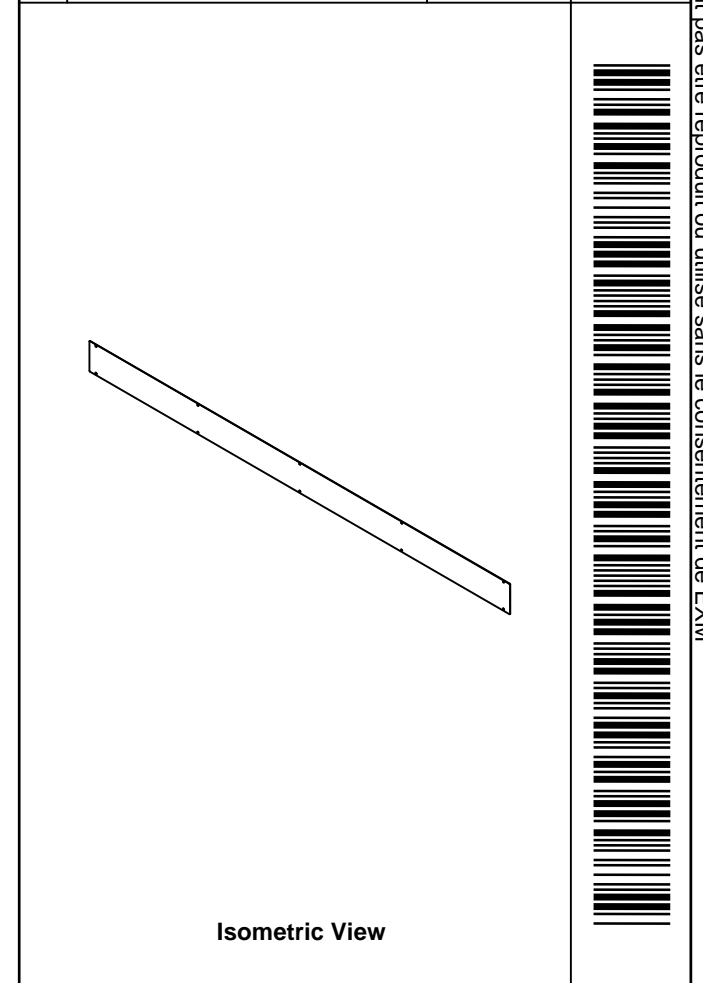

Tél: (450) 979-4373 Fax: (450) 979-4626 <a href="http://www.exmweb.com">www.exmweb.com</a>		Flatness Aplatissement	
		Max 3.0mm	
Customer Client		Date	
Drawn By Dessiné Par BoxCad: BoxCad		Date 13-Apr-15	
Material Matière 16 Ga Cold Rolled A1008 CS Type B (1.4mm)			
Color Couleur Asa-61 Grey		Finish Fini Smooth	
Description 1100WDN 6" x 96" Cover			Detail Rev.
Part Number Numéro Pièce <b>1100WD060696NC</b>			Rev. 3 <b>0</b>

Qty	Part Number	Rev	Description
1	STK-S-00950	1	UL 74SL Pull-Box Sticker
1	STK-S-00800	2	CSA Electrical Box Sticker
1	STK-P-02400S	0	Powder Paint (Asa-61 Grey / Smooth)
1	1100WD060696NC-P	0	1100WDN 6" x 96" Cover Part
Parts List			