

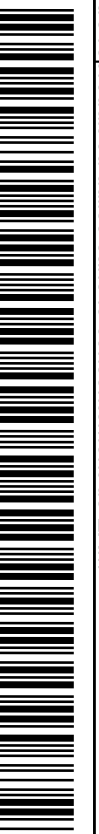

This drawing is confidential and must not be reproduced or used without the consent of EXM

Ce dessin est confidentiel et ne doit pas être reproduit ou utilisé sans le consentement de EXM

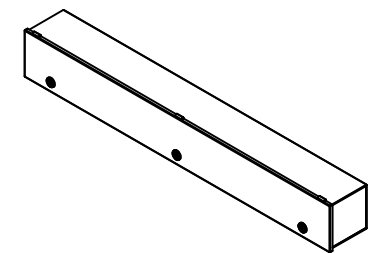
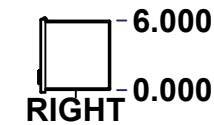
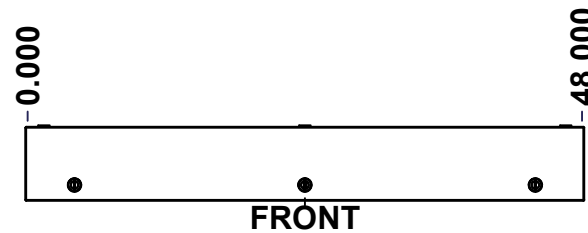
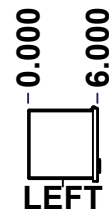
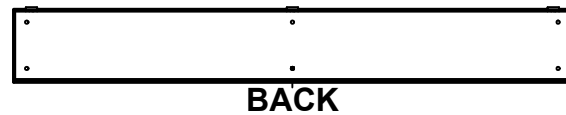
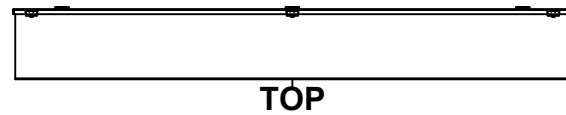

No.	Revisions	Date	By/Par

Isometric View

 Tél: (450) 979-4373 Fax: (450) 979-4626 www.exmweb.com		Flatness Aplatissement	
		Max 3.0mm	
Customer Client		Date	
Drawn By Dessiné Par BoxCad: BoxCad		Date 20-May-15	
Material Matière 16 Ga Cold Rolled A1008 CS Type B (1.4mm)			
Color Couleur Asa-61 Grey		Finish Fini Smooth	
Description 1100WEN 6" x 6" x 48" Assembly			Detail Rev.
Part Number Numéro Pièce 1100WE060648N		Rev. 0	1 2

SEE BILL OF MATERIAL ON LAST PAGE

This drawing is confidential and must not be reproduced or used without the consent of EXM

Ce dessin est confidentiel et ne doit pas être reproduit ou utilisé sans le consentement de EXM

NOTE	
ITEM	DESCRIPTION
1	NEMA 1 Enclosure
2	C/W Standard ground provision on box and cover
3	W/O Standard door stiffener
4	W/O Inner panel
5	W/O Inner panel mounting provision

No.	Revisions	Date	By/Par

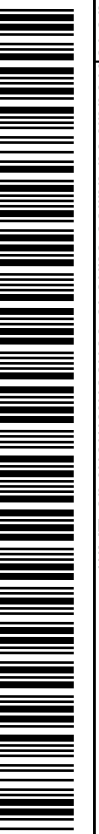
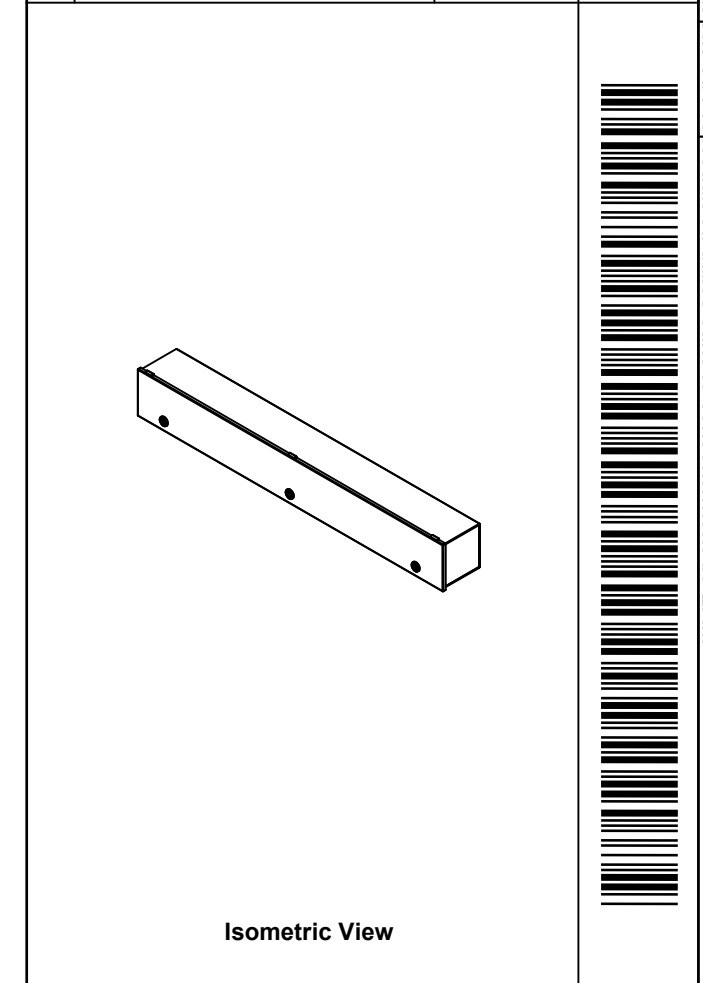

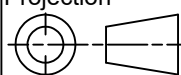
 Tél: (450) 979-4373 Fax: (450) 979-4626 www.exmweb.com		Flatness Aplatissement Max 3.0mm Projection 
Customer Client	Date	
Drawn By Dessiné Par	BoxCad: BoxCad	Date 20-May-15
Material Matière	16 Ga Cold Rolled A1008 CS Type B (1.4mm)	
Color Couleur	Asa-61 Grey	Finish Fini Smooth
Description	Detail Rev.	
1100WEN 6" x 6" x 48" Assembly		Rev. 2
Part Number Numéro Pièce	1100WE060648N	0

PACKING		
ITEM	QTY	DESCRIPTION
Thermal plastic film	1	Use with Packing Tunnel Wrapper Machine
Packaging label	1	White label with product number

Qty	Part Number	Rev	Description
1	1100WE060648NC	0	1100WEN 6" x 48" Cover
1	1100WE060648NB	0	1100WEN 6" x 6" x 48" Body
Parts List			

This drawing is confidential and must not be reproduced or used without the consent of EXM

Ce dessin est confidentiel et ne doit pas être reproduit ou utilisé sans le consentement de EXM



TOP

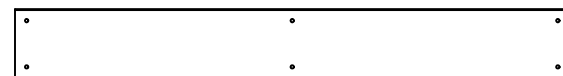

BACK



BOTTOM

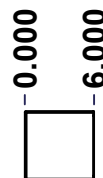

LEFT



FRONT

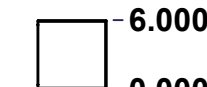

RIGHT

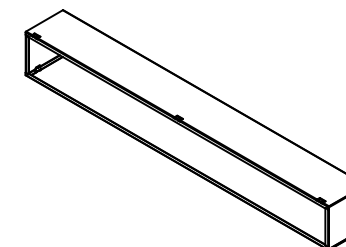

Isometric View



No.	Revisions	Date	By/Par

 Tél: (450) 979-4373 Fax: (450) 979-4626 www.exmweb.com		Flatness Aplatissement  Max 3.0mm Projection 
Customer Client	Date	
Drawn By Dessiné Par	BoxCad: BoxCad	Date 20-May-15
Material Matière	16 Ga Cold Rolled A1008 CS Type B (1.4mm)	
Color Couleur	Asa-61 Grey	Finish Fini Smooth
Description 1100WEN 6" x 6" x 48" Body		Detail Rev.
Part Number Numéro Pièce	Rev. 0	1 / 7

SEE BILL OF MATERIAL ON LAST PAGE

1100WE060648NB

This drawing is confidential and must not be reproduced or used without the consent of EXM

Ce dessin est confidentiel et ne doit pas être reproduit ou utilisé sans le consentement de EXM

STANDARD FEATURES ARE NOT LISTED IN THIS HOLE TABLE			
HOLE TABLE - BACK VIEW (CUSTOM FEATURE ONLY)			
CUT-OUT	XDIM	YDIM	DESCRIPTION
1	24.000	5.000	RND Ø0.290
2	24.000	1.000	RND Ø0.290
3	47.000	1.000	RND Ø0.290
4	47.000	5.000	RND Ø0.290
5	1.000	5.000	RND Ø0.290
6	1.000	1.000	RND Ø0.290

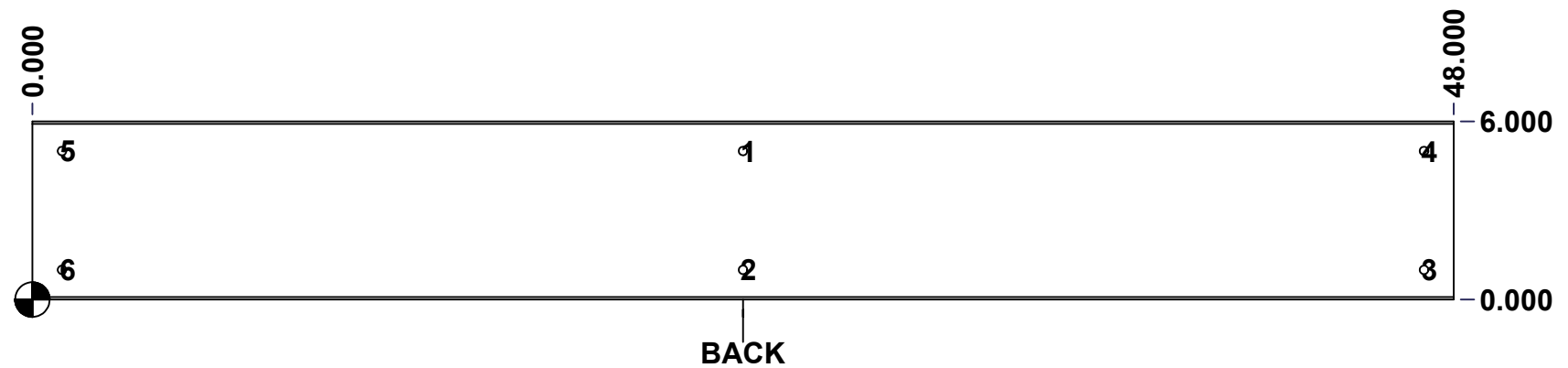

	Description	Status
	1100WEN 6" x 6" x 48" Body	(NULL)
	Part Number Numéro Pièce	Rev.
	1100WE060648NB	0
		6
		7

This drawing is confidential and must not be reproduced or used without the consent of EXM

Ce dessin est confidentiel et ne doit pas être reproduit ou utilisé sans le consentement de EXM

No.	Revisions	Date	By/Par

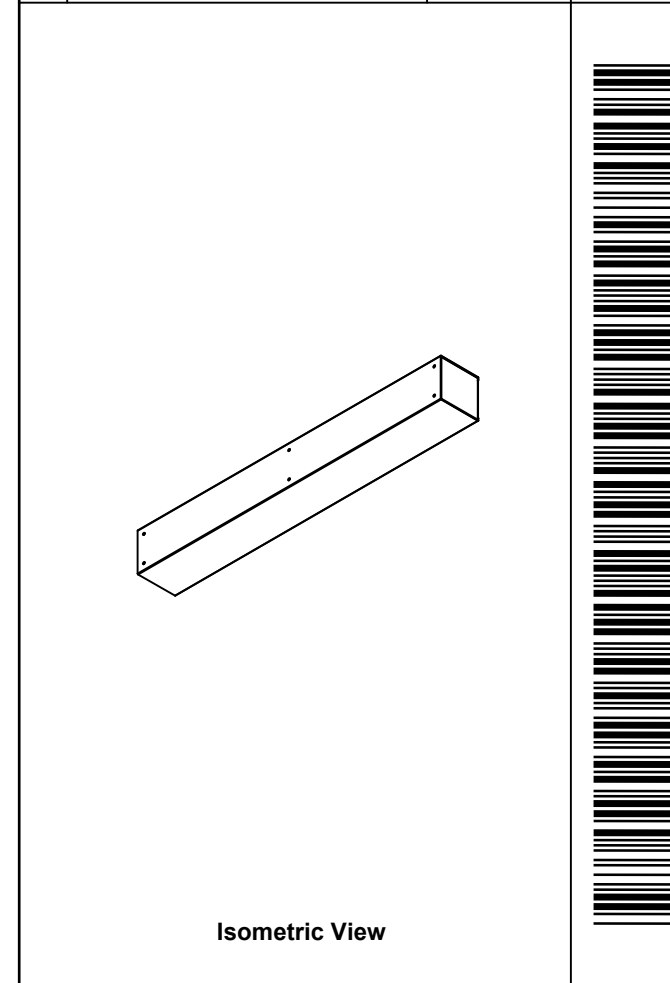

 Tél: (450) 979-4373 Fax: (450) 979-4626 www.exmweb.com	Flatness Aplatissement
	Max 3.0mm
Projection	

Customer Client	Date
Drawn By Dessiné Par BoxCad: BoxCad	Date 20-May-15

Material
Matière 16 Ga Cold Rolled A1008 CS Type B (1.4mm)

Color Couleur Asa-61 Grey	Finish Fini Smooth
------------------------------	-----------------------

Qty	Part Number	Rev	Description
1	1100WE060648NR-P	0	1100WEN 6" x 6" Body Part
1	1100WE060648NL-P	0	1100WEN 6" x 6" Body Part
1	1100WE060648NB-P	0	1100WEN 6" x 6" x 48" Body Part
1	STK-P-02400S	0	Powder Paint (Asa-61 Grey / Smooth)
Parts List			

Description 1100WEN 6" x 6" x 48" Body		Detail Rev.	
Part Number Numéro Pièce 1100WE060648NB		Rev. 0	7

This drawing is confidential and must not be reproduced or used without the consent of EXM

Ce dessin est confidentiel et ne doit pas être reproduit ou utilisé sans le consentement de EXM

TOP

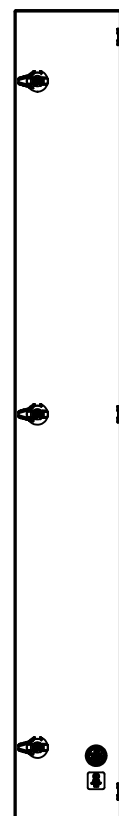

BACK

0.000
0.450

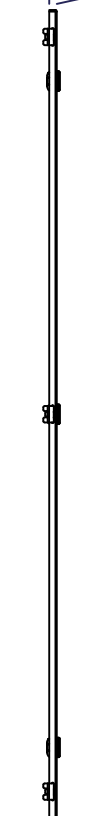

LEFT

0.000
6.400

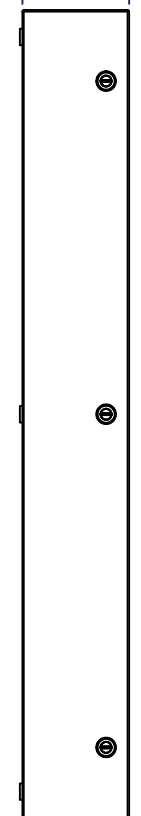

FRONT

48.400

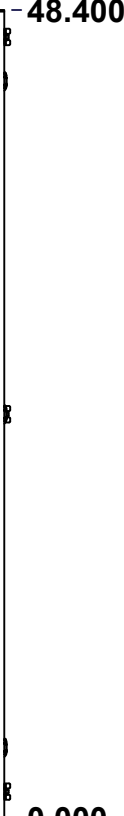

RIGHT

BOTTOM

No.	Revisions	Date	By/Par

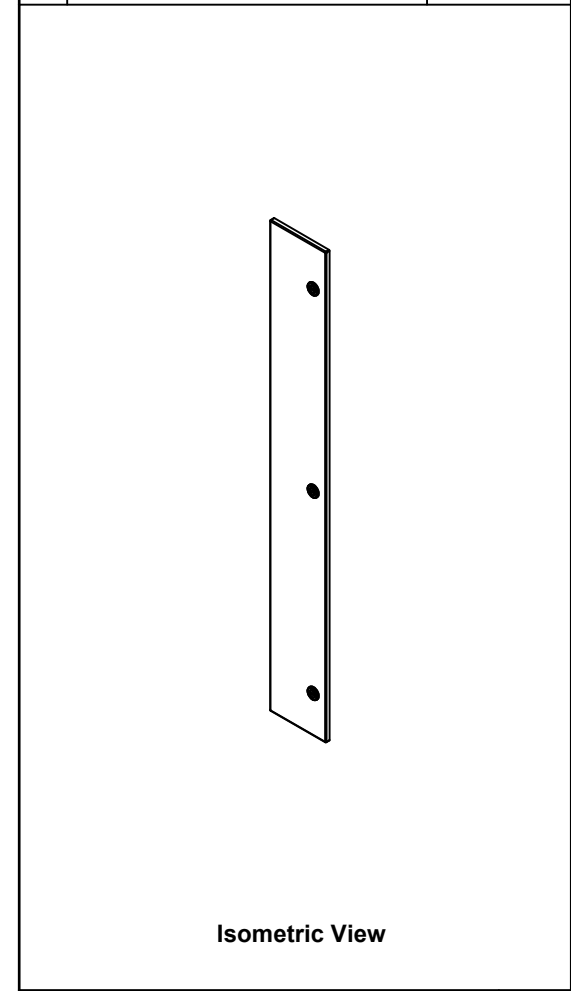

Isometric View



 Tél: (450) 979-4373 Fax: (450) 979-4626 www.exmweb.com		Flatness Aplatissement Max 3.0mm Projection 
Customer Client	Date	
Drawn By Dessiné Par	BoxCad: BoxCad	Date 20-May-15
Material Matière	16 Ga Cold Rolled A1008 CS Type B (1.4mm)	
Color Couleur	Asa-61 Grey	Finish Fini Smooth
Description 1100WEN 6" x 48" Cover		Detail Rev.
Part Number Numéro Pièce	Rev. 0	1 3

SEE BILL OF MATERIAL ON LAST PAGE

1100WE060648NC

This drawing is confidential and must not be reproduced or used without the consent of EXM

Ce dessin est confidentiel et ne doit pas être reproduit ou utilisé sans le consentement de EXM

STANDARD FEATURES ARE NOT LISTED IN THIS HOLE TABLE			
HOLE TABLE - FRONT VIEW (CUSTOM FEATURE ONLY)			
CUT-OUT	XDIM	YDIM	DESCRIPTION
1	4.250	1.375	LOCK 880 SCQ1-SL @ 270.0°
2	24.200	1.375	LOCK 880 SCQ1-SL @ 270.0°
3	44.150	1.375	LOCK 880 SCQ1-SL @ 270.0°

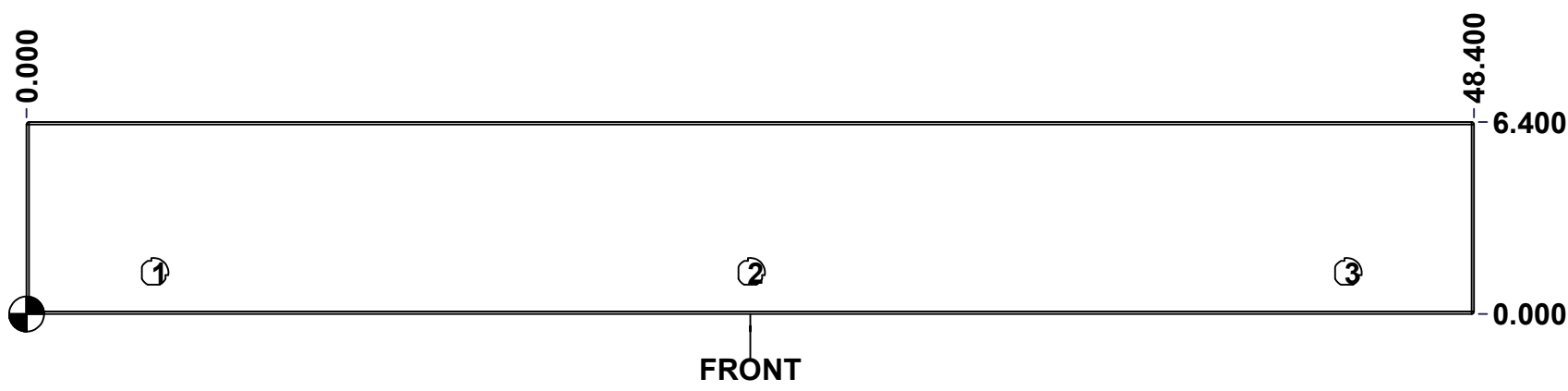

	Description	Status	
	1100WEN 6" x 48" Cover	(NULL)	
	Part Number Numéro Pièce	Rev.	
	1100WE060648NC	0	2 3

This drawing is confidential and must not be reproduced or used without the consent of EXM

Ce dessin est confidentiel et ne doit pas être reproduit ou utilisé sans le consentement de EXM

No.	Revisions	Date	By/Par

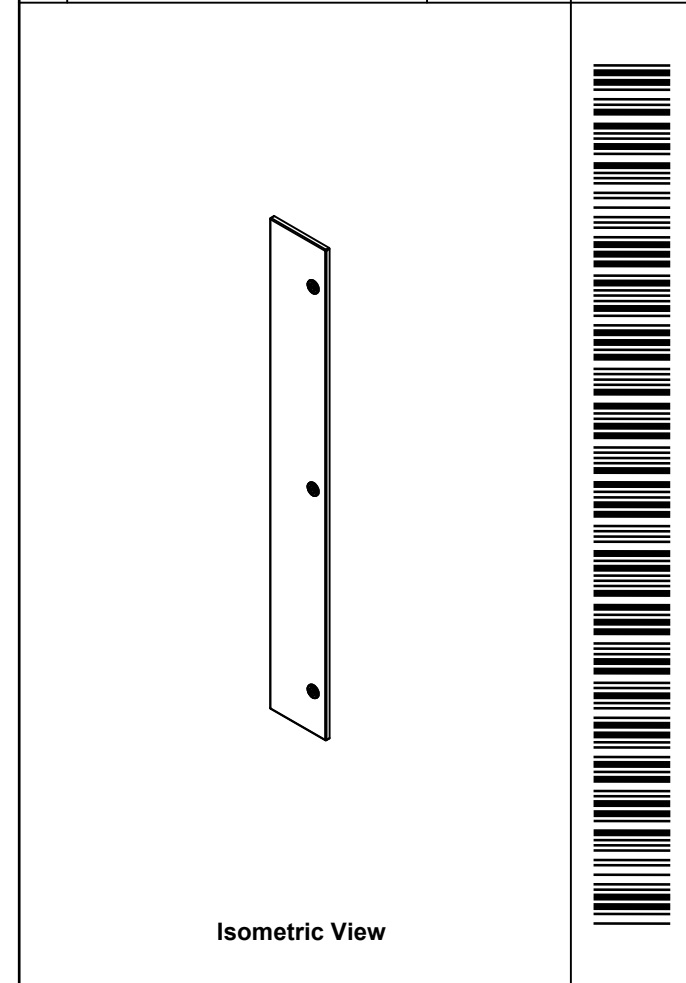

Tél: (450) 979-4373 Fax: (450) 979-4626 www.exmweb.com		Flatness Aplatissement
		Max 3.0mm
Customer Client		Date
Drawn By Dessiné Par BoxCad: BoxCad		Date 20-May-15
Material Matière 16 Ga Cold Rolled A1008 CS Type B (1.4mm)		
Color Couleur Asa-61 Grey	Finish Fini Smooth	
Description 1100WEN 6" x 48" Cover		Detail Rev.
Part Number Numéro Pièce 1100WE060648NC		Rev. 3

1	STK-S-00900	0	UL Cut-Out Box Sticker
1	STK-S-00800	2	CSA Electrical Box Sticker
3	STK-Q-33361	0	Spring Steel Hinge
1	1100WE060648NC-P	0	1100WEN 6" x 48" Cover Part
1	STK-P-02400S	0	Powder Paint (Asa-61 Grey / Smooth)
3	880 SCQ1-SL	0	1100 1/4 Turn Lock
Qty	Part Number	Rev	Description
Parts List			