

This drawing is confidential and must not be reproduced or used without the consent of EXM

Ce dessin est confidentiel et ne doit pas être reproduit ou utilisé sans le consentement de EXM

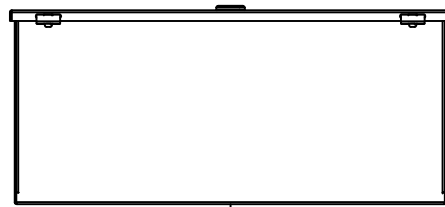

TOP



BACK

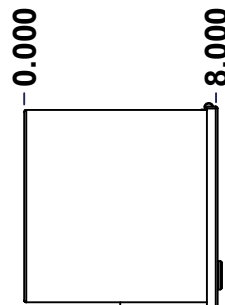

LEFT

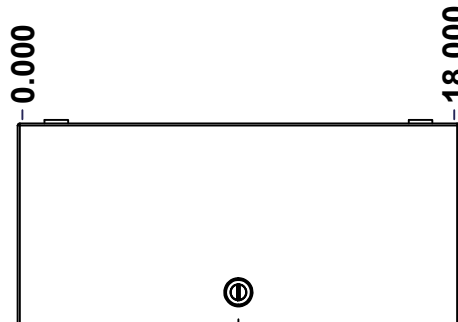

FRONT

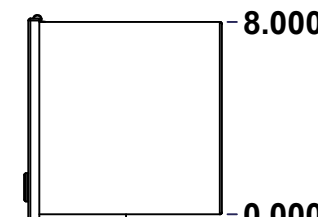

RIGHT



BOTTOM

No.	Revisions	Date	By/Par

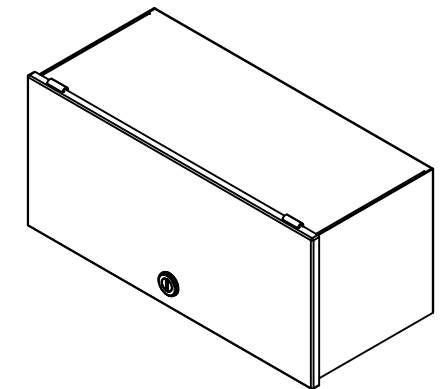

Isometric View

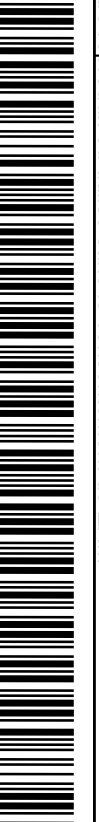

Tél: (450) 979-4373
 Fax: (450) 979-4626
www.exmweb.com

Flatness
Aplatissement

Max 3.0mm

Projection

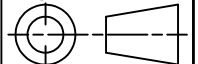

Customer Client	Date
Drawn By / Dessiné Par: BoxCad: BoxCad	Date: 27-May-15
Material / Matière: 16 Ga Cold Rolled A1008 CS Type B (1.4mm)	
Color / Couleur: Asa-61 Grey	Finish / Fini: Smooth
Description: 1100WEN 8" x 8" x 18" Assembly	Detail Rev.
Part Number / Numéro Pièce: 1100WE080818N	Rev. 0

SEE BILL OF MATERIAL ON LAST PAGE

1
2

This drawing is confidential and must not be reproduced or used without the consent of EXM

Ce dessin est confidentiel et ne doit pas être reproduit ou utilisé sans le consentement de EXM

NOTE	
ITEM	DESCRIPTION
1	NEMA 1 Enclosure
2	C/W Standard ground provision on box and cover
3	W/O Standard door stiffener
4	W/O Inner panel
5	W/O Inner panel mounting provision

No.	Revisions	Date	By/Par

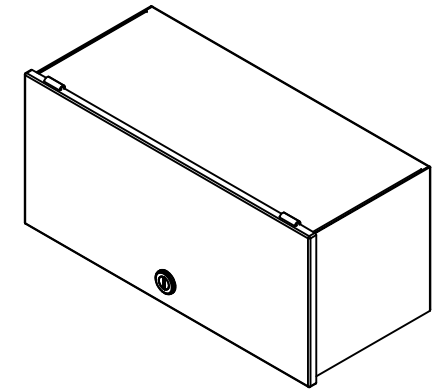

Isometric View

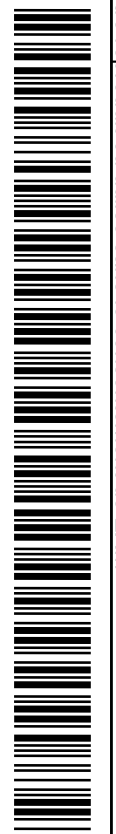

Tél: (450) 979-4373
 Fax: (450) 979-4626
www.exmweb.com

Flatness
Aplatissement
Max 3.0mm
Projection

Customer Client	Date
Drawn By / Dessiné Par: BoxCad: BoxCad	Date: 27-May-15
Material / Matière: 16 Ga Cold Rolled A1008 CS Type B (1.4mm)	
Color / Couleur: Asa-61 Grey	Finish / Fini: Smooth

PACKING		
ITEM	QTY	DESCRIPTION
Thermal plastic film	1	Use with Packing Tunnel Wrapper Machine
Packaging label	1	White label with product number

1	1100WE080818NC	0	1100WEN 8" x 18" Cover
1	1100WE080818NB	0	1100WEN 8" x 8" x 18" Body
Qty	Part Number	Rev	Description
Parts List			

Description: 1100WEN 8" x 8" x 18" Assembly	Detail Rev.
Part Number / Numéro Pièce: 1100WE080818N	Rev. 0

2
2

This drawing is confidential and must not be reproduced or used without the consent of EXM

Ce dessin est confidentiel et ne doit pas être reproduit ou utilisé sans le consentement de EXM

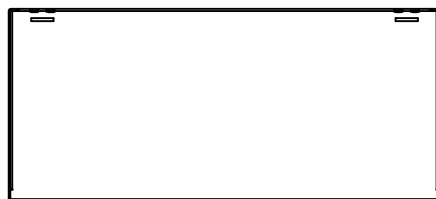

TOP

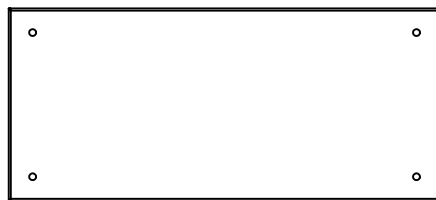

BACK

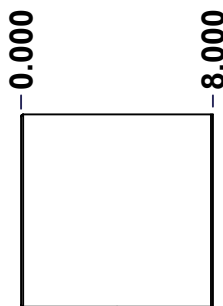

LEFT

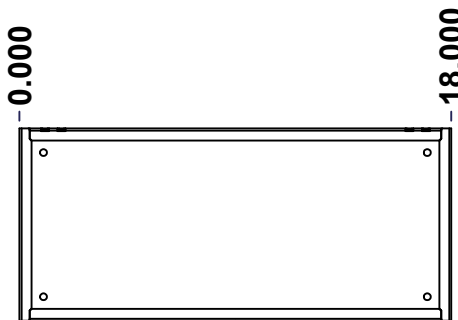

FRONT

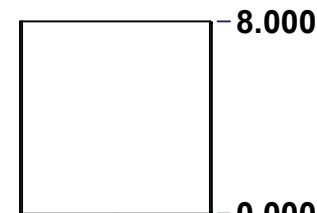

RIGHT

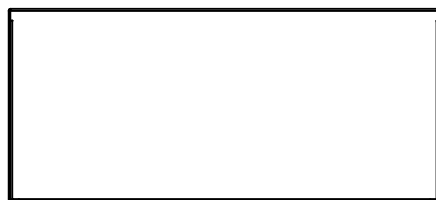

BOTTOM

No.	Revisions	Date	By/Par

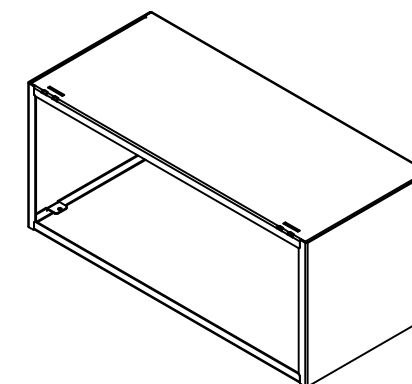

Isometric View



Tél: (450) 979-4373
 Fax: (450) 979-4626
www.exmweb.com

Flatness
Aplatissement

Max 3.0mm

Projection

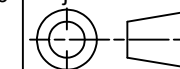

Customer Client	Date
Drawn By / Dessiné Par: BoxCad: BoxCad	Date: 27-May-15
Material / Matière: 16 Ga Cold Rolled A1008 CS Type B (1.4mm)	
Color / Couleur: Asa-61 Grey	Finish / Fini: Smooth
Description: 1100WEN 8" x 8" x 18" Body	Detail Rev.
Part Number / Numéro Pièce: 1100WE080818NB	Rev. 0

SEE BILL OF MATERIAL ON LAST PAGE

1 / 7

This drawing is confidential and must not be reproduced or used without the consent of EXM

Ce dessin est confidentiel et ne doit pas être reproduit ou utilisé sans le consentement de EXM

STANDARD FEATURES ARE NOT LISTED IN THIS HOLE TABLE			
HOLE TABLE - BACK VIEW (CUSTOM FEATURE ONLY)			
CUT-OUT	XDIM	YDIM	DESCRIPTION
1	17.000	1.000	RND Ø0.290
2	17.000	7.000	RND Ø0.290
3	1.000	7.000	RND Ø0.290
4	1.000	1.000	RND Ø0.290



	Description	Status	
	1100WEN 8" x 8" x 18" Body	(NULL)	
	Part Number Numéro Pièce	Rev.	
	1100WE080818NB	0	6 7

This drawing is confidential and must not be reproduced or used without the consent of EXM

Ce dessin est confidentiel et ne doit pas être reproduit ou utilisé sans le consentement de EXM

No.	Revisions	Date	By/Par

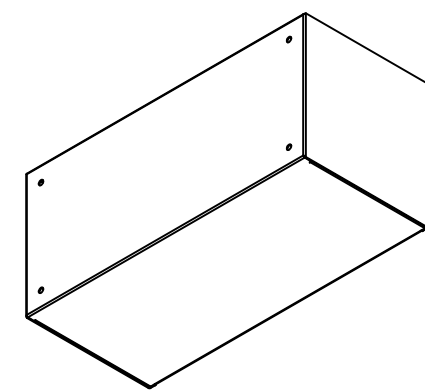

Isometric View

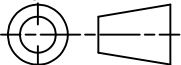

 Tél: (450) 979-4373 Fax: (450) 979-4626 www.exmweb.com		Flatness Aplatissement Max 3.0mm Projection 														
Customer Client	Date															
Drawn By Dessiné Par	BoxCad: BoxCad	Date 27-May-15														
Material Matière 16 Ga Cold Rolled A1008 CS Type B (1.4mm)																
Color Couleur	Asa-61 Grey	Finish Fini Smooth														
Description 1100WEN 8" x 8" x 18" Body		Detail Rev.														
Part Number Numéro Pièce	1100WE080818NB	Rev. 0														
<table border="1"> <thead> <tr> <th>Qty</th> <th>Part Number</th> <th>Rev</th> <th>Description</th> </tr> </thead> <tbody> <tr> <td>1</td> <td>1100WE080818NB-P</td> <td>0</td> <td>1100WEN 8" x 8" x 18" Body Part</td> </tr> <tr> <td>1</td> <td>STK-P-02400S</td> <td>0</td> <td>Powder Paint (Asa-61 Grey / Smooth)</td> </tr> </tbody> </table>		Qty	Part Number	Rev	Description	1	1100WE080818NB-P	0	1100WEN 8" x 8" x 18" Body Part	1	STK-P-02400S	0	Powder Paint (Asa-61 Grey / Smooth)	<table border="1"> <tr> <td>7</td> </tr> <tr> <td>7</td> </tr> </table>	7	7
Qty	Part Number	Rev	Description													
1	1100WE080818NB-P	0	1100WEN 8" x 8" x 18" Body Part													
1	STK-P-02400S	0	Powder Paint (Asa-61 Grey / Smooth)													
7																
7																
Parts List																

This drawing is confidential and must not be reproduced or used without the consent of EXM

Ce dessin est confidentiel et ne doit pas être reproduit ou utilisé sans le consentement de EXM

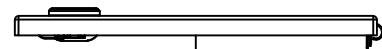

TOP

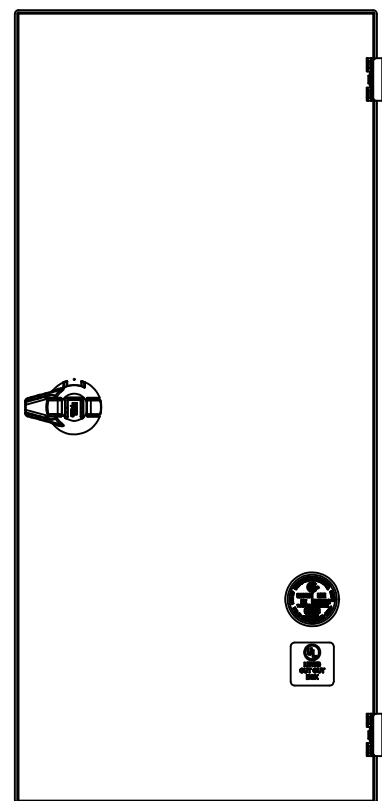

BACK

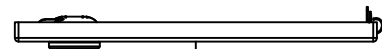

BOTTOM

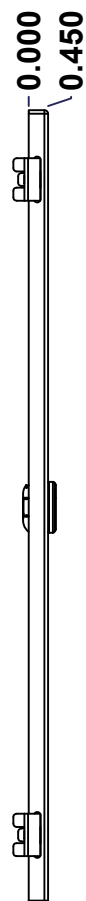

LEFT

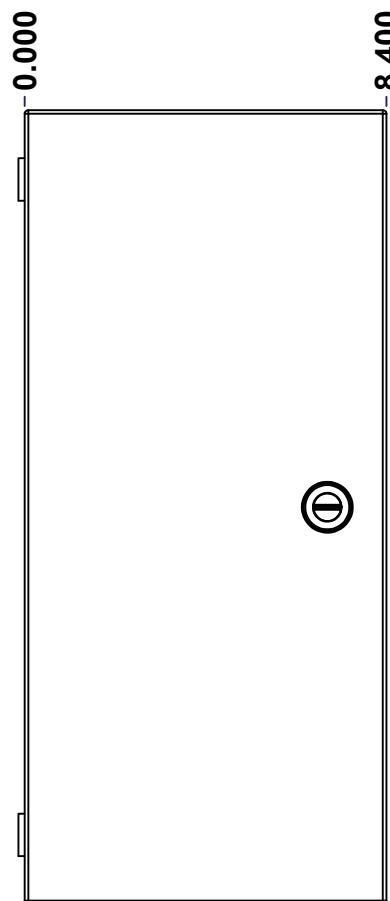

FRONT

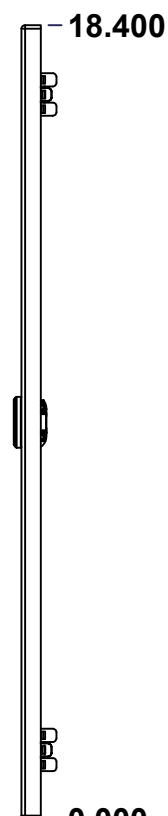

RIGHT

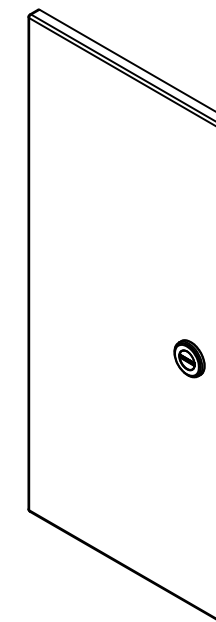

Isometric View

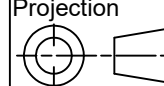

No.	Revisions	Date	By/Par

 Tél: (450) 979-4373 Fax: (450) 979-4626 www.exmweb.com		Flatness Aplatissement Max 3.0mm Projection 
Customer Client	Date	
Drawn By Dessiné Par	BoxCad: BoxCad	Date 27-May-15
Material Matière	16 Ga Cold Rolled A1008 CS Type B (1.4mm)	
Color Couleur	Asa-61 Grey	Finish Finis Smooth
Description 1100WEN 8" x 18" Cover		Detail Rev.
Part Number Numéro Pièce	Rev. 0	1 / 3

SEE BILL OF MATERIAL ON LAST PAGE

1100WE080818NC

This drawing is confidential and must not be reproduced or used without the consent of EXM

Ce dessin est confidentiel et ne doit pas être reproduit ou utilisé sans le consentement de EXM

STANDARD FEATURES ARE NOT LISTED IN THIS HOLE TABLE			
HOLE TABLE - FRONT VIEW (CUSTOM FEATURE ONLY)			
CUT-OUT	XDIM	YDIM	DESCRIPTION
1	9.200	1.375	LOCK 880 SCQ1-SL @ 270.0°

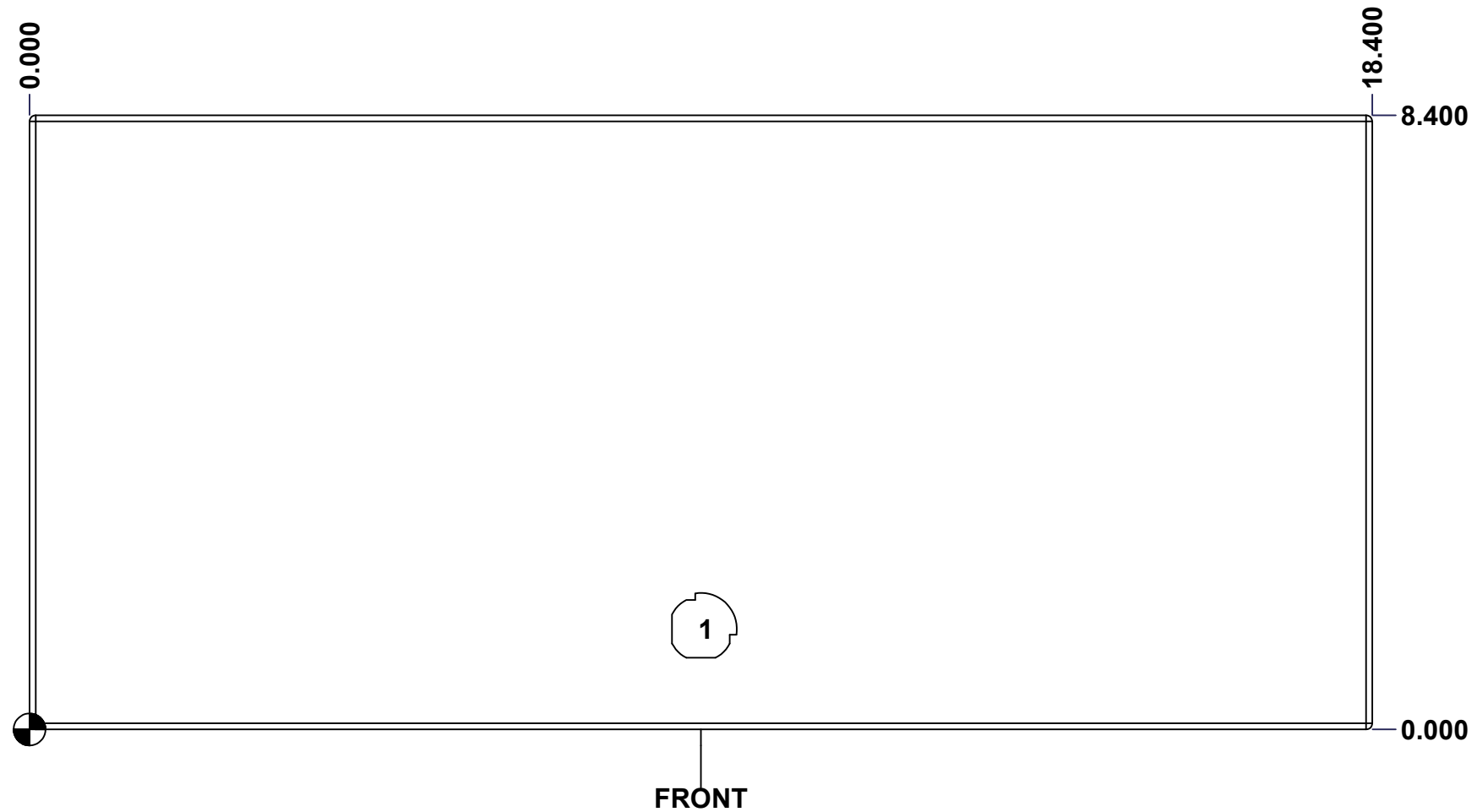

	Description	Status	
	1100WEN 8" x 18" Cover	(NULL)	
	Part Number Numéro Pièce	Rev.	
	1100WE080818NC	0	2 3

This drawing is confidential and must not be reproduced or used without the consent of EXM

Ce dessin est confidentiel et ne doit pas être reproduit ou utilisé sans le consentement de EXM

No.	Revisions	Date	By/Par

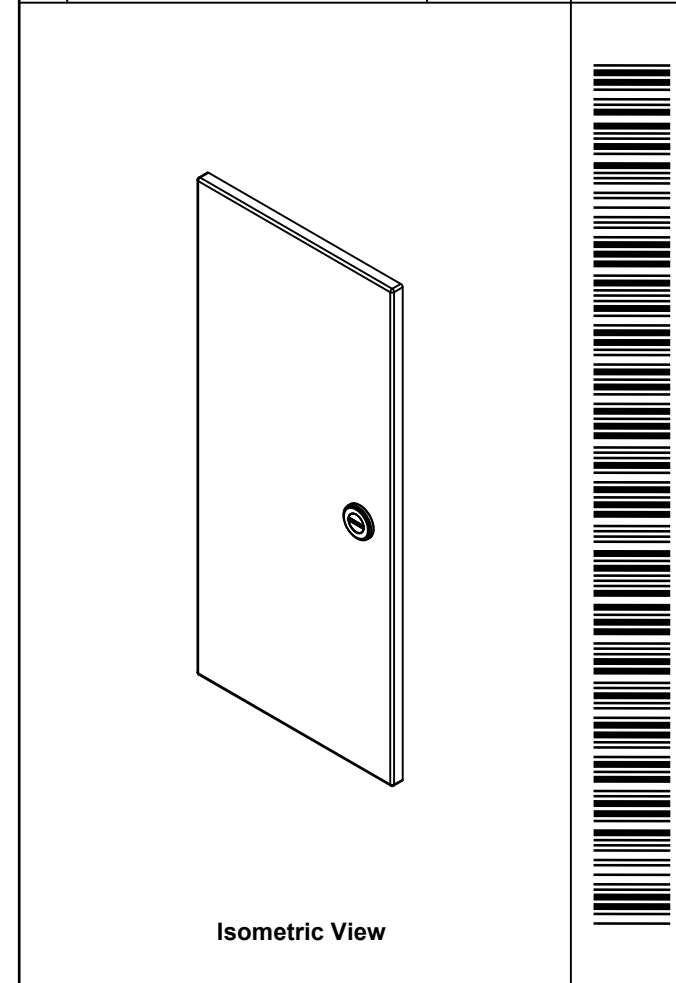

Isometric View

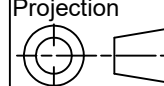
 Tél: (450) 979-4373 Fax: (450) 979-4626 www.exmweb.com		Flatness Aplatissement Max 3.0mm Projection 
Customer Client	Date	
Drawn By Dessiné Par	BoxCad: BoxCad	Date 27-May-15
Material Matière	16 Ga Cold Rolled A1008 CS Type B (1.4mm)	
Color Couleur	Asa-61 Grey	Finish Fini Smooth
Description		Detail Rev.
1100WEN 8" x 18" Cover		
Part Number Numéro Pièce	Rev. 3	3
1100WE080818NC		0

Qty	Part Number	Rev	Description
1	880 SCQ1-SL	0	1100 1/4 Turn Lock
1	STK-S-00900	0	UL Cut-Out Box Sticker
1	STK-S-00800	2	CSA Electrical Box Sticker
2	STK-Q-33361	0	Spring Steel Hinge
1	1100WE080818NC-P	0	1100WEN 8" x 18" Cover Part
1	STK-P-02400S	0	Powder Paint (Asa-61 Grey / Smooth)
Parts List			