

This drawing is confidential and must not be reproduced or used without the consent of EXM

Ce dessin est confidentiel et ne doit pas être reproduit ou utilisé sans le consentement de EXM

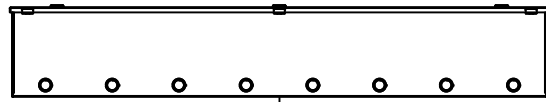

TOP

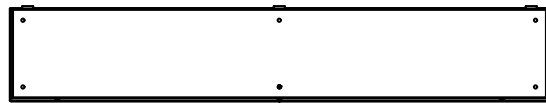

BACK

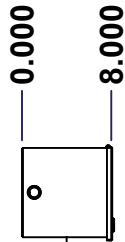

LEFT

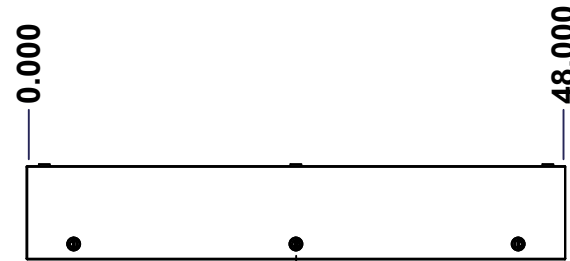

FRONT

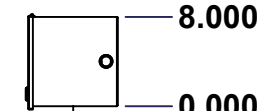

RIGHT

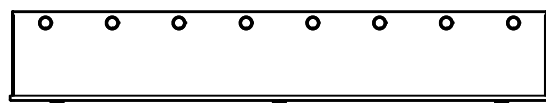

BOTTOM

No.	Revisions	Date	By/Par

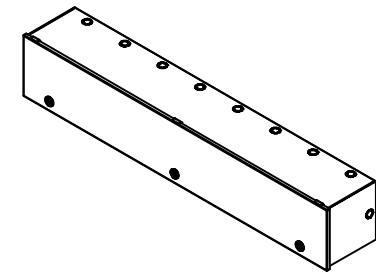

Isometric View



Tél: (450) 979-4373  
 Fax: (450) 979-4626  
[www.exmweb.com](http://www.exmweb.com)

Flatness  
Aplatissement  
Max 3.0mm  
Projection

Customer Client	Date
Drawn By Dessiné Par BoxCad: BoxCad	Date 17-Aug-17
Material Matière 16 Ga Cold Rolled A1008 CS Type B (1.4mm)	
Color Couleur Asa-61 Grey	Finish Fini Smooth
Description 1100WE 8" x 8" x 48" Assembly	Detail Rev.
Part Number Numéro Pièce <b>1100WE080848</b>	Rev. <b>0</b>

SEE BILL OF MATERIAL ON LAST PAGE

1  
8

This drawing is confidential and must not be reproduced or used without the consent of EXM

Ce dessin est confidentiel et ne doit pas être reproduit ou utilisé sans le consentement de EXM

NOTE	
ITEM	DESCRIPTION
1	NEMA 1 Enclosure (IP20)
2	C/W Standard ground provision on box and cover
3	W/O Standard door stiffener
4	W/O Inner panel
5	W/O Inner panel mounting provision

No.	Revisions	Date	By/Par

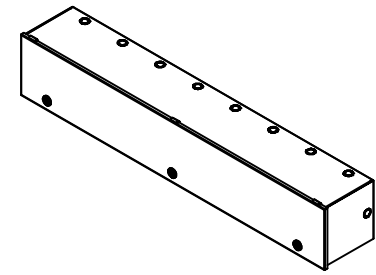

Isometric View



Tél: (450) 979-4373  
 Fax: (450) 979-4626  
[www.exmweb.com](http://www.exmweb.com)

Flatness  
Aplatissement  
Max 3.0mm  
Projection

Customer Client	Date
Drawn By / Dessiné Par: BoxCad: BoxCad	Date: 17-Aug-17
Material / Matière: 16 Ga Cold Rolled A1008 CS Type B (1.4mm)	

Color / Couleur: Asa-61 Grey	Finish / Fini: Smooth
------------------------------	-----------------------

Description: 1100WE 8" x 8" x 48" Assembly	Detail Rev.
--	-------------

Part Number / Numéro Pièce: <b>1100WE080848</b>	Rev. 0	2/8
---	--------	-----

PACKING		
ITEM	QTY	DESCRIPTION
Thermal plastic film	1	Use with Packing Tunnel Wrapper Machine
Packaging label	1	White label with product number

Qty	Part Number	Rev	Description
1	1100WE080848C	0	1100WE 8" x 48" Cover
1	1100WE080848B	0	1100WE 8" x 8" x 48" Body
Parts List			

This drawing is confidential and must not be reproduced or used without the consent of EXM

Ce dessin est confidentiel et ne doit pas être reproduit ou utilisé sans le consentement de EXM

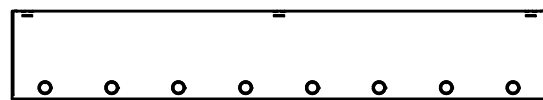

TOP

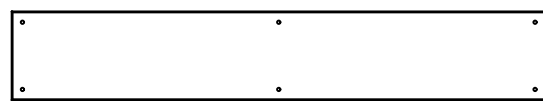

BACK

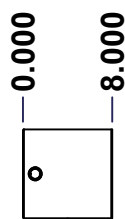

LEFT

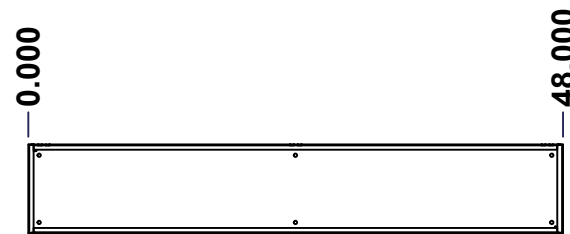

FRONT

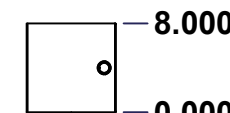

RIGHT

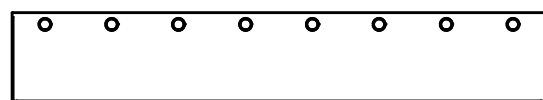

BOTTOM

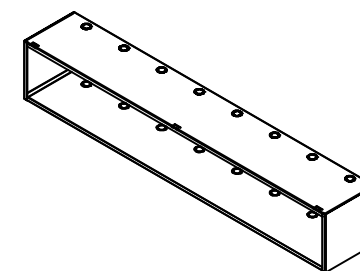

Isometric View

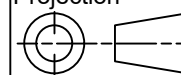

No.	Revisions	Date	By/Par

 Tél: (450) 979-4373 Fax: (450) 979-4626 <a href="http://www.exmweb.com">www.exmweb.com</a>		Flatness Aplatissement Max 3.0mm Projection 
Customer Client	Date	
Drawn By Dessiné Par	BoxCad: BoxCad	Date 17-Aug-17
Material Matière	16 Ga Cold Rolled A1008 CS Type B (1.4mm)	
Color Couleur	Asa-61 Grey	Finish Fini Smooth
Description 1100WE 8" x 8" x 48" Body		Detail Rev.
Part Number Numéro Pièce	1100WE080848B	Rev. 3 0

SEE BILL OF MATERIAL ON LAST PAGE

This drawing is confidential and must not be reproduced or used without the consent of EXM

Ce dessin est confidentiel et ne doit pas être reproduit ou utilisé sans le consentement de EXM

**STANDARD FEATURES ARE NOT LISTED IN THIS HOLE TABLE**

**HOLE TABLE - BACK VIEW (CUSTOM FEATURE ONLY)**

CUT-OUT	XDIM	YDIM	DESCRIPTION
1	24.000	7.000	RND Ø0.290
2	24.000	1.000	RND Ø0.290
3	47.000	1.000	RND Ø0.290
4	47.000	7.000	RND Ø0.290
5	1.000	7.000	RND Ø0.290
6	1.000	1.000	RND Ø0.290

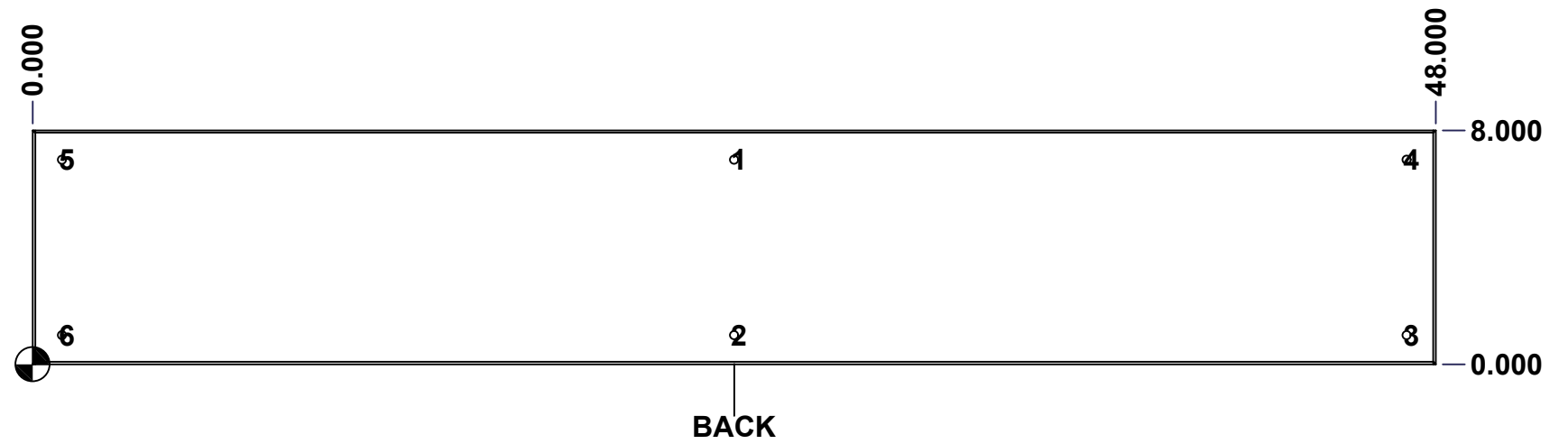

	Description	Status	
	1100WE 8" x 8" x 48" Body	(NULL)	
	Part Number Numéro Pièce	Rev.	
	<b>1100WE080848B</b>	<b>0</b>	4 8

This drawing is confidential and must not be reproduced or used without the consent of EXM

Ce dessin est confidentiel et ne doit pas être reproduit ou utilisé sans le consentement de EXM

No.	Revisions	Date	By/Par

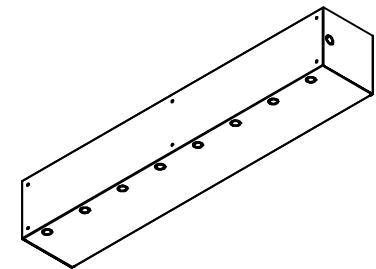

Isometric View

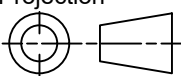

 Tél: (450) 979-4373 Fax: (450) 979-4626 <a href="http://www.exmweb.com">www.exmweb.com</a>	Flatness Aplatissement	Max 3.0mm
	Projection	
Customer Client	Date	
Drawn By Dessiné Par	BoxCad: BoxCad	Date 17-Aug-17
Material Matière	16 Ga Cold Rolled A1008 CS Type B (1.4mm)	
Color Couleur	Asa-61 Grey	Finish Fini Smooth
Description	Detail Rev.	
1100WE 8" x 8" x 48" Body		
Part Number Numéro Pièce	Rev.	5
<b>1100WE080848B</b>	<b>0</b>	8

Qty	Part Number	Rev	Description
1	STK-P-02400S	0	Powder Paint (Asa-61 Grey / Smooth)
1	1100WE080848B-P	0	1100WE 8" x 8" x 48" Body Part
Parts List			

This drawing is confidential and must not be reproduced or used without the consent of EXM

Ce dessin est confidentiel et ne doit pas être reproduit ou utilisé sans le consentement de EXM

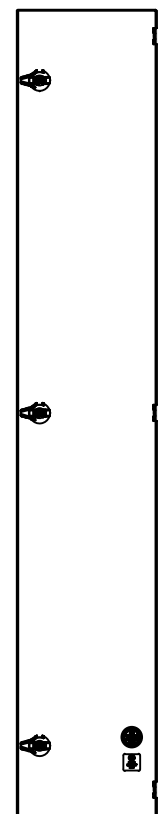
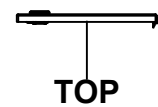

BACK

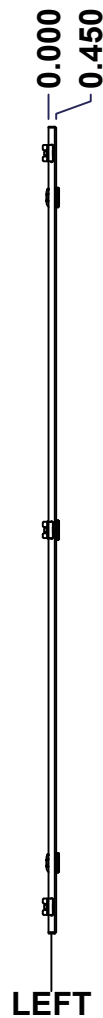

LEFT

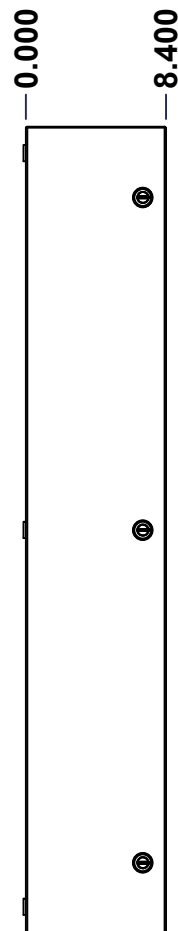

FRONT

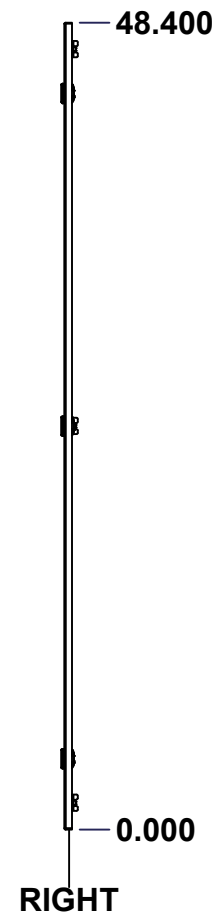

RIGHT

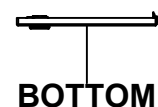

BOTTOM

No.	Revisions	Date	By/Par

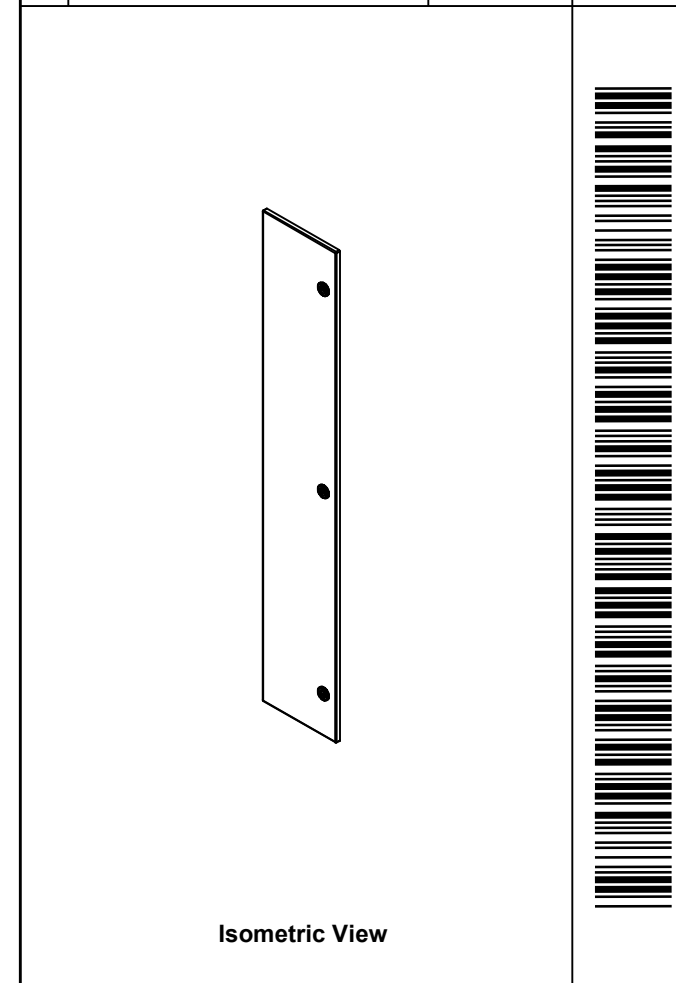

Isometric View

Tél: (450) 979-4373 Fax: (450) 979-4626 <a href="http://www.exmweb.com">www.exmweb.com</a>		Flatness Aplatissement Max 3.0mm Projection 
Customer Client	Date	
Drawn By Dessiné Par	BoxCad: BoxCad	Date 17-Aug-17
Material Matière	16 Ga Cold Rolled A1008 CS Type B (1.4mm)	
Color Couleur	Asa-61 Grey	Finish Fini Smooth
Description	Detail Rev.	
1100WE 8" x 48" Cover		
Part Number Numéro Pièce	Rev.	6
<b>1100WE080848C</b>	<b>0</b>	8

SEE BILL OF MATERIAL ON LAST PAGE

This drawing is confidential and must not be reproduced or used without the consent of EXM

Ce dessin est confidentiel et ne doit pas être reproduit ou utilisé sans le consentement de EXM

STANDARD FEATURES ARE NOT LISTED IN THIS HOLE TABLE			
HOLE TABLE - FRONT VIEW (CUSTOM FEATURE ONLY)			
CUT-OUT	XDIM	YDIM	DESCRIPTION
1	4.250	1.375	LOCK 880 SCQ1-SL @ 270.0°
2	24.200	1.375	LOCK 880 SCQ1-SL @ 270.0°
3	44.150	1.375	LOCK 880 SCQ1-SL @ 270.0°

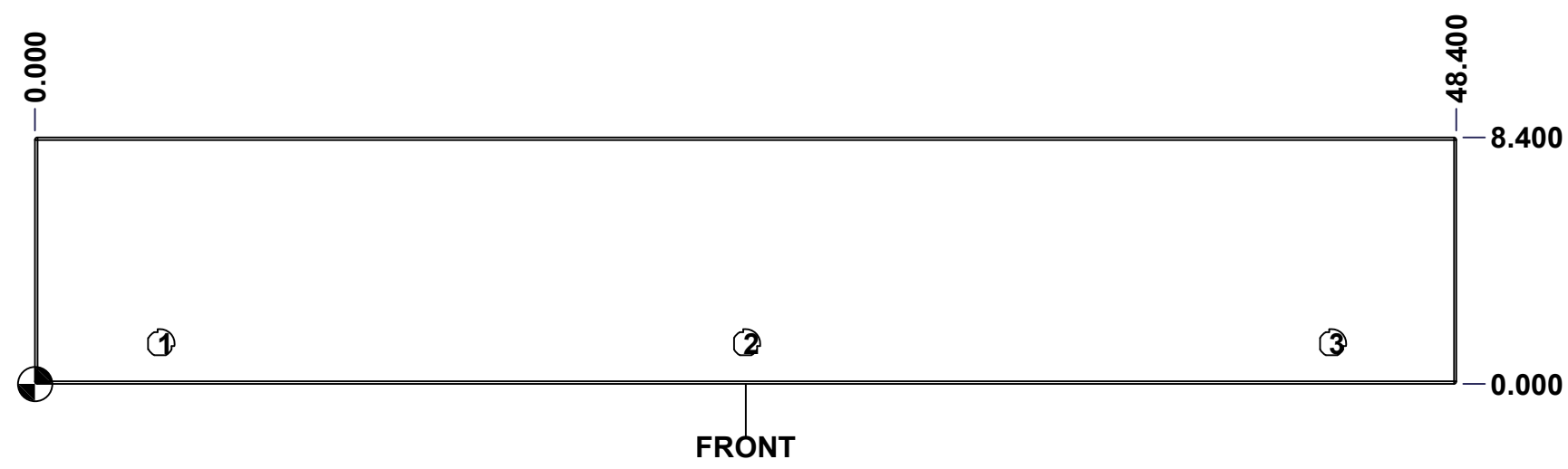



	Description	Status	
	1100WE 8" x 48" Cover	(NULL)	
	Part Number Numéro Pièce	Rev.	
	<b>1100WE080848C</b>	<b>0</b>	7/8

This drawing is confidential and must not be reproduced or used without the consent of EXM

Ce dessin est confidentiel et ne doit pas être reproduit ou utilisé sans le consentement de EXM

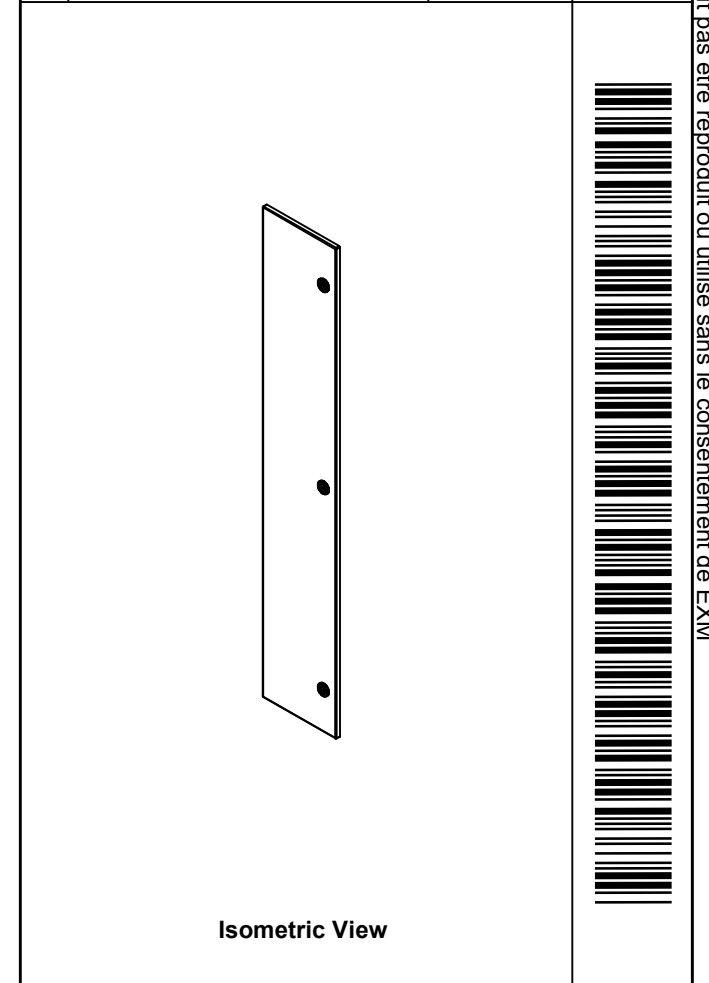
No.	Revisions	Date	By/Par

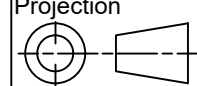

 Tél: (450) 979-4373 Fax: (450) 979-4626 <a href="http://www.exmweb.com">www.exmweb.com</a>	Flatness Aplatissement
	Max 3.0mm
Projection	
Customer Client	Date
Drawn By Dessiné Par	Date 17-Aug-17
Material Matière	16 Ga Cold Rolled A1008 CS Type B (1.4mm)

QTY	Part Number	Rev	Description
1	STK-S-00900	0	UL Cut-Out Box Sticker
1	STK-S-00800	2	CSA Electrical Box Sticker
3	STK-Q-33361	0	Spring Steel Hinge
1	STK-P-02400S	0	Powder Paint (Asa-61 Grey / Smooth)
1	1100WE080848C-P	0	1100WE 8" x 48" Cover Part
3	880 SCQ1-SL	0	1100 1/4 Turn Lock
Parts List			

Color Couleur	Asa-61 Grey	Finish Fini	Smooth
Description	1100WE 8" x 48" Cover		Detail Rev.
Part Number Numéro Pièce	<b>1100WE080848C</b>		Rev. 8
			<b>0</b>