

This drawing is confidential and must not be reproduced or used without the consent of EXM

Ce dessin est confidentiel et ne doit pas être reproduit ou utilisé sans le consentement de EXM

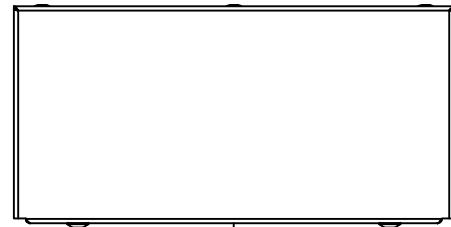

TOP

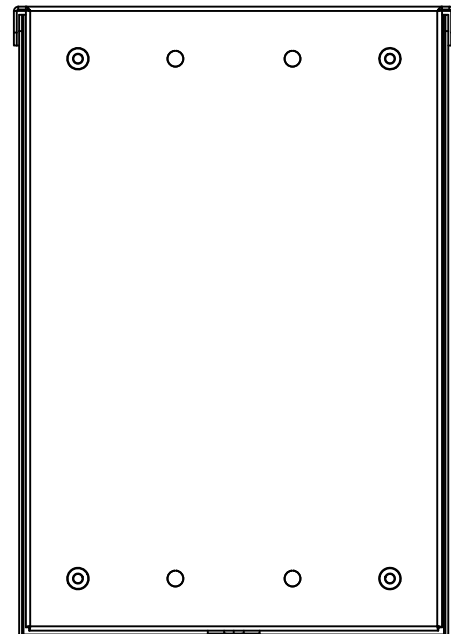

BACK

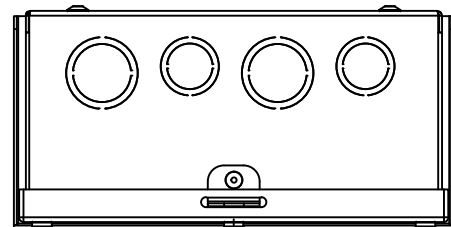

BOTTOM

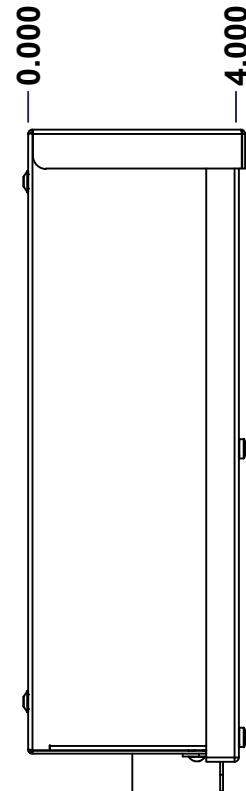

LEFT

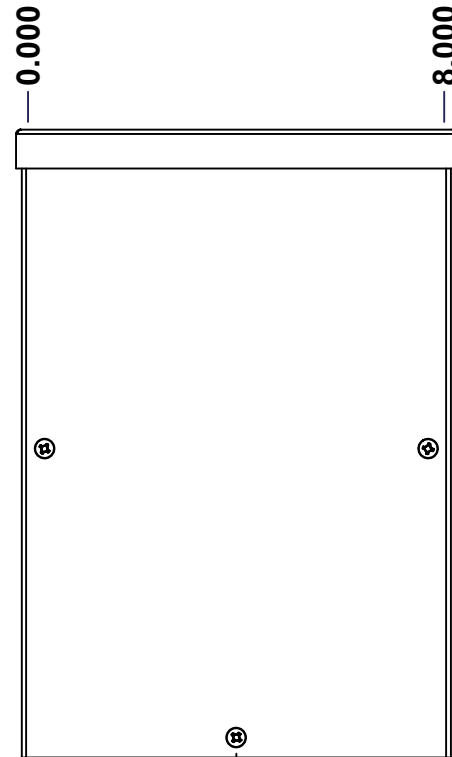

FRONT

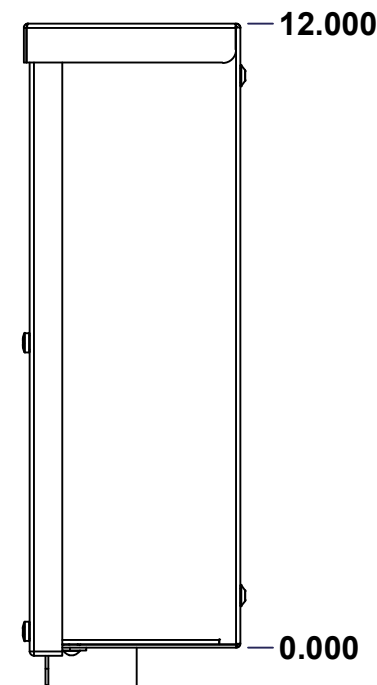

RIGHT

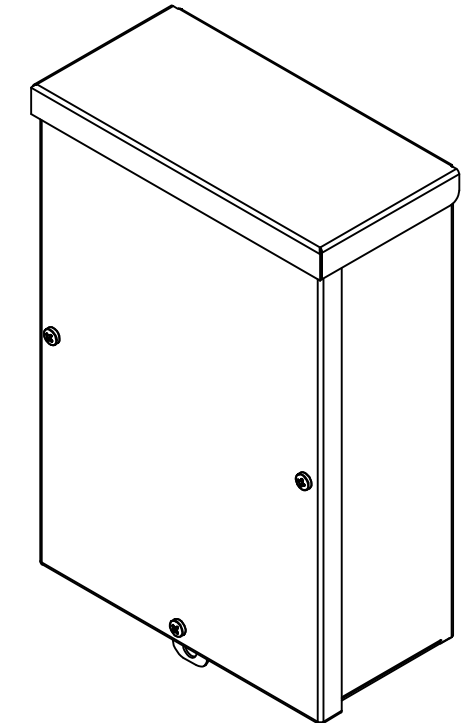

Isometric View

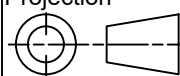

No.	Revisions	Date	By/Par

 Tél: (450) 979-4373 Fax: (450) 979-4626 www.exmweb.com		Flatness Aplatissement Max 3.0mm Projection 
Customer Client	Date	
Drawn By Dessiné Par	BoxCad: BoxCad	Date 17-Oct-19
Material Matière	16 Ga H.R.P. & O. (1.4mm)	
Color Couleur	Asa-61 Grey	Finish Fini Smooth
Description	1300 12" x 8" x 4" Assembly	
Part Number Numéro Pièce	1300120804	Detail Rev. Rev. 1 0 / 7

SEE BILL OF MATERIAL ON LAST PAGE

This drawing is confidential and must not be reproduced or used without the consent of EXM

Ce dessin est confidentiel et ne doit pas être reproduit ou utilisé sans le consentement de EXM

NOTE	
ITEM	DESCRIPTION
1	NEMA 3/3R Enclosure
2	W/O Standard door stiffener
3	W/O Inner panel
4	W/O Inner panel mounting standoffs

No.	Revisions	Date	By/Par

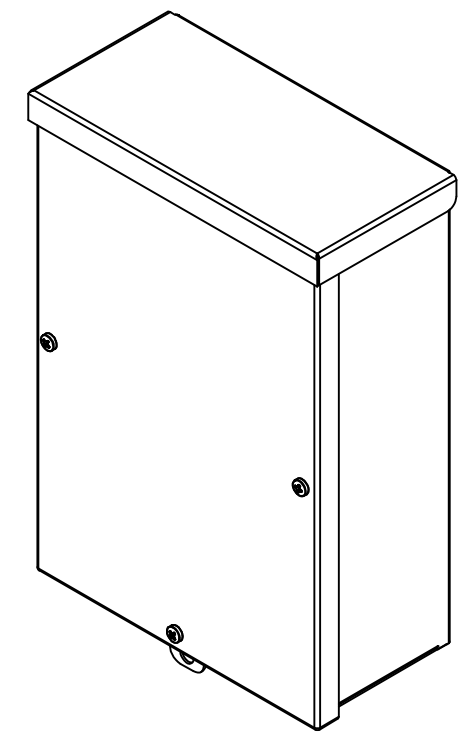

Isometric View



Tél: (450) 979-4373
 Fax: (450) 979-4626
www.exmweb.com

Flatness
Aplatissement
Max 3.0mm
Projection

Customer Client	Date
Drawn By / Dessiné Par: BoxCad: BoxCad	Date: 17-Oct-19
Material / Matière: 16 Ga H.R.P. & O. (1.4mm)	
Color / Couleur: Asa-61 Grey	Finish / Fini: Smooth

PACKING		
ITEM	QTY	DESCRIPTION
Thermal plastic film	1	Use with Packing Tunnel Wrapper Machine
Packaging label	1	White label with product number

1	STK-K-03100	3	1300 CH - Accessory Kit
1	1300120804C	0	1300 12" x 8" Cover
1	1300120804B	0	1300 12" x 8" x 4" Body
Qty	Part Number	Rev	Description
Parts List			

Description: 1300 12" x 8" x 4" Assembly	Detail Rev.
Part Number / Numéro Pièce: 1300120804	Rev. 0

2
7

This drawing is confidential and must not be reproduced or used without the consent of EXM

Ce dessin est confidentiel et ne doit pas être reproduit ou utilisé sans le consentement de EXM

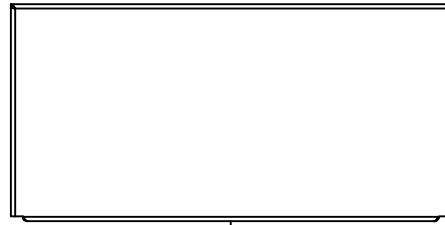

TOP

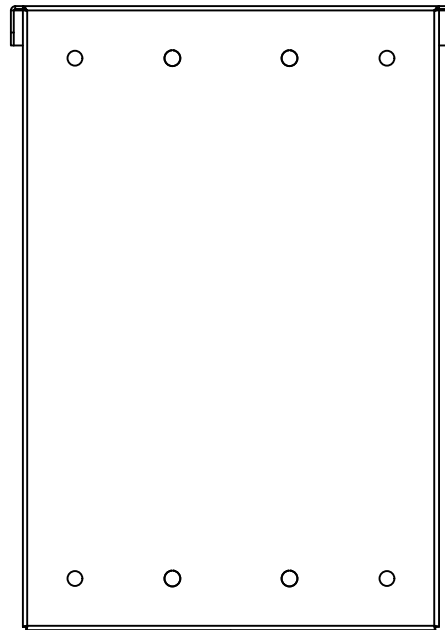

BACK

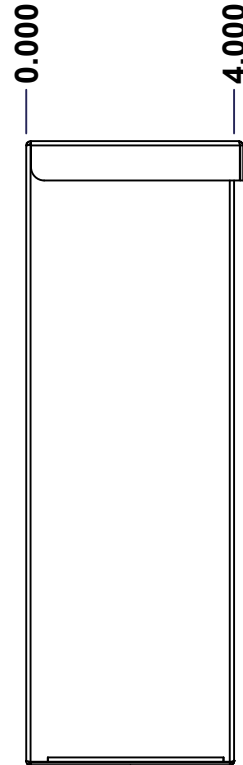

LEFT

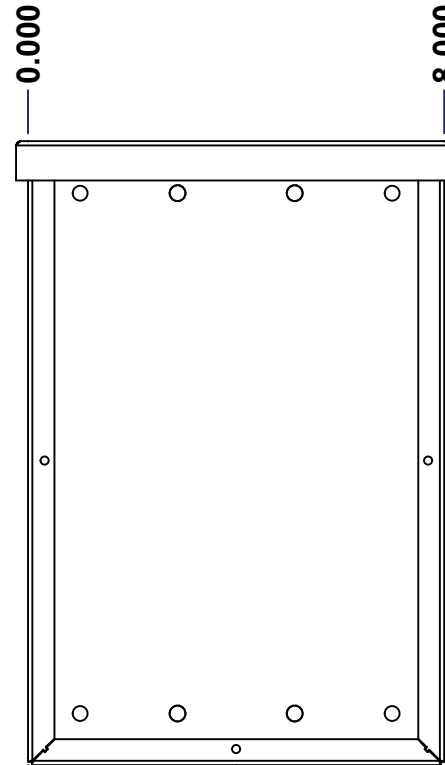

FRONT

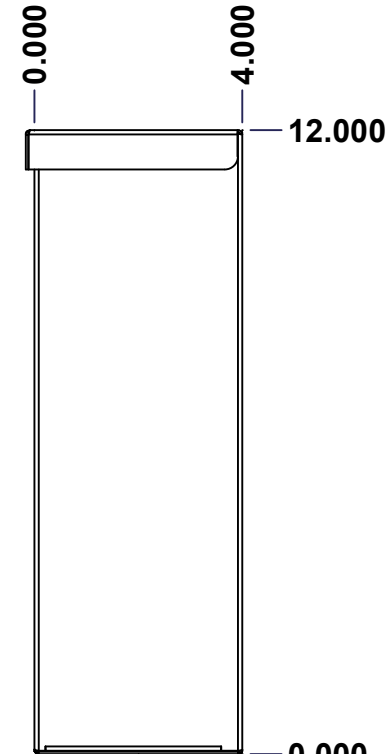

RIGHT

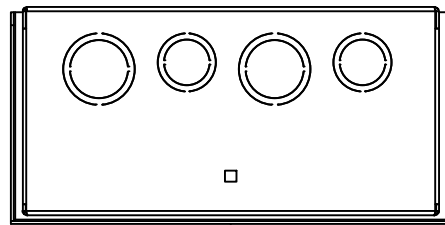

BOTTOM

No.	Revisions	Date	By/Par

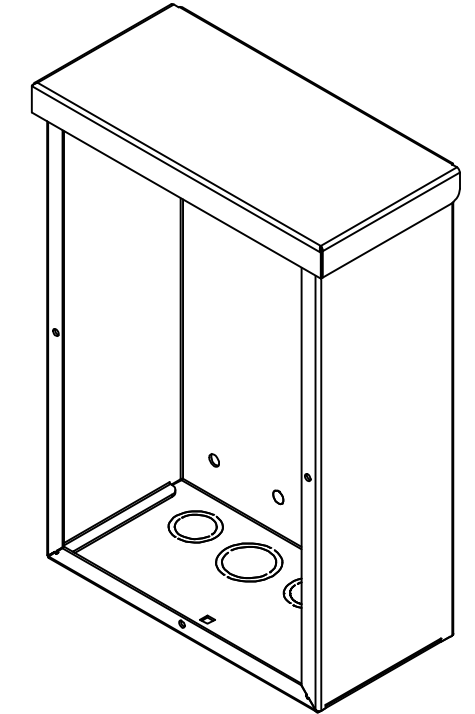

Isometric View



Tél: (450) 979-4373
 Fax: (450) 979-4626
www.exmweb.com

Flatness
Aplatissement

Max 3.0mm

Projection



Customer Client	Date
Drawn By / Dessiné Par: BoxCad: BoxCad	Date: 17-Oct-19
Material Matière: 16 Ga H.R.P. & O. (1.4mm)	
Color Couleur: Asa-61 Grey	Finish Fini: Smooth
Description: 1300 12" x 8" x 4" Body	Detail Rev.

Part Number / Numéro Pièce: 1300120804B	Rev. 0	3 / 7
-----------------------------------------	--------	-------

SEE BILL OF MATERIAL ON LAST PAGE

This drawing is confidential and must not be reproduced or used without the consent of EXM

Ce dessin est confidentiel et ne doit pas être reproduit ou utilisé sans le consentement de EXM

STANDARD FEATURES ARE NOT LISTED IN THIS HOLE TABLE

HOLE TABLE - BOTTOM VIEW (CUSTOM FEATURE ONLY)

CUT-OUT	XDIM	YDIM	DESCRIPTION
1	1.468	1.063	DKO Ø1.125 - 0.875
2	6.532	1.188	DKO Ø1.375 - 1.125
3	4.844	1.063	DKO Ø1.125 - 0.875
4	3.156	1.188	DKO Ø1.375 - 1.125

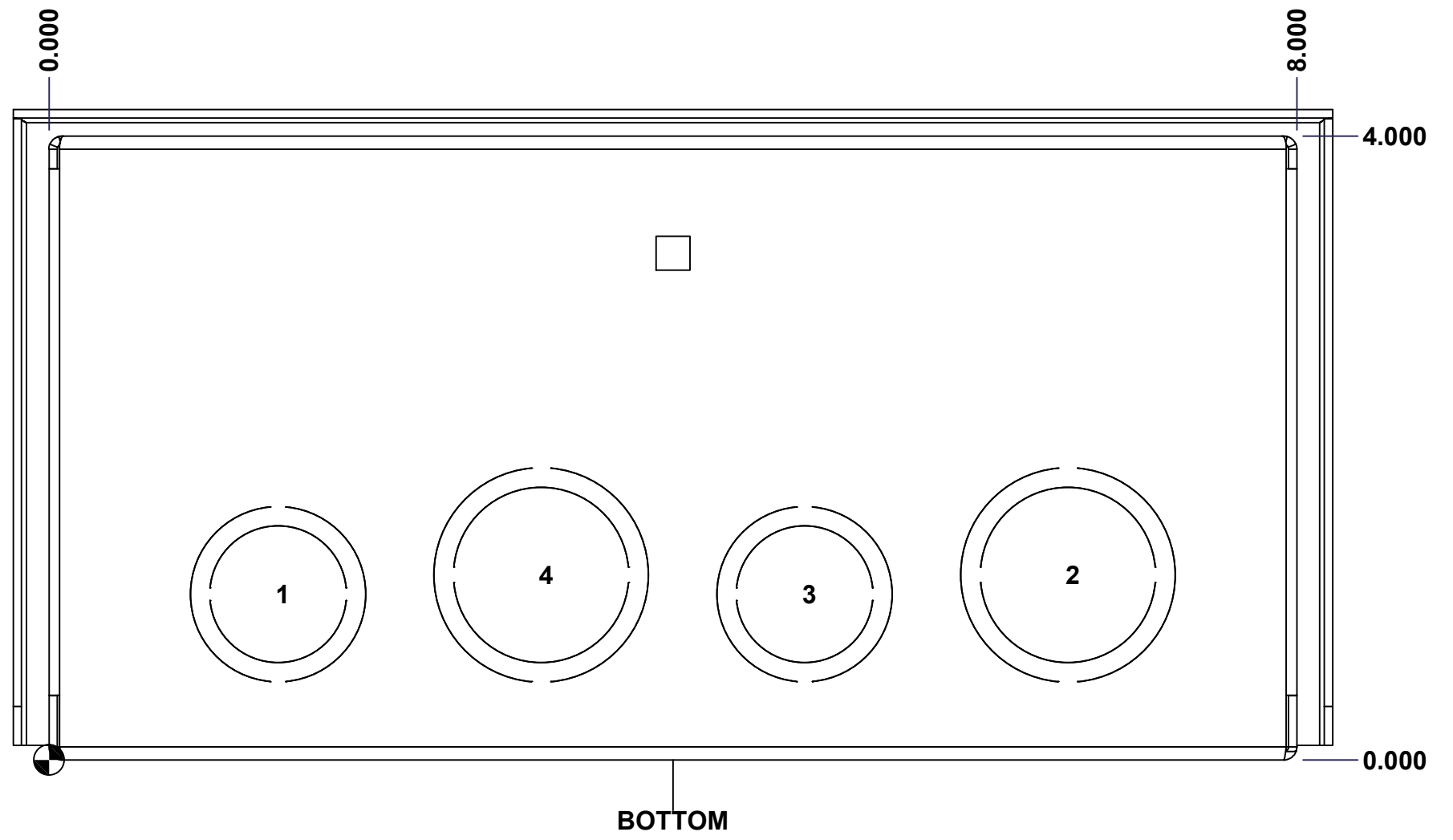

	Description	Status	
	1300 12" x 8" Body	(NULL)	
	Part Number Numéro Pièce	Rev.	
	1300120804B	0	4 7

This drawing is confidential and must not be reproduced or used without the consent of EXM

Ce dessin est confidentiel et ne doit pas être reproduit ou utilisé sans le consentement de EXM

No.	Revisions	Date	By/Par

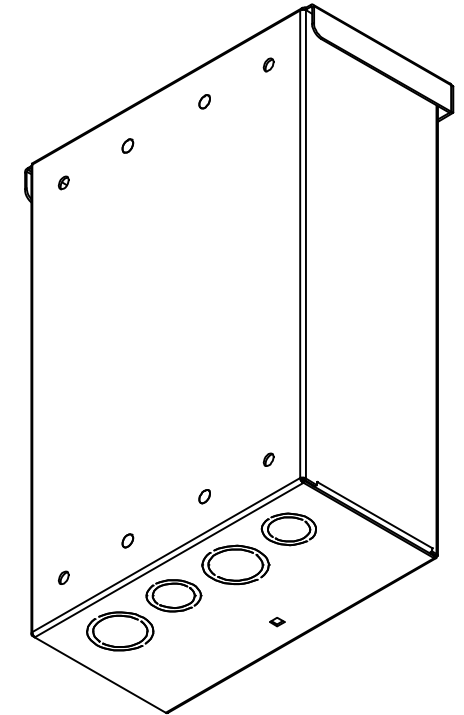

Isometric View



Tél: (450) 979-4373
 Fax: (450) 979-4626
www.exmweb.com

Flatness
Aplatissement

Max 3.0mm

Projection

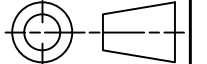

Customer Client	Date
Drawn By / Dessiné Par: BoxCad: BoxCad	Date: 17-Oct-19
Material / Matière: 16 Ga H.R.P. & O. (1.4mm)	
Color / Couleur: Asa-61 Grey	Finish / Fini: Smooth

Qty	Part Number	Rev	Description
1	STK-P-02400S	0	Powder Paint (Asa-61 Grey / Smooth)
1	1300120804B-P	0	1300 12" x 8" Body Part
Parts List			

Description: 1300 12" x 8" x 4" Body	Detail Rev.
Part Number / Numéro Pièce: 1300120804B	Rev. 0 / 5 / 7

This drawing is confidential and must not be reproduced or used without the consent of EXM

Ce dessin est confidentiel et ne doit pas être reproduit ou utilisé sans le consentement de EXM



TOP

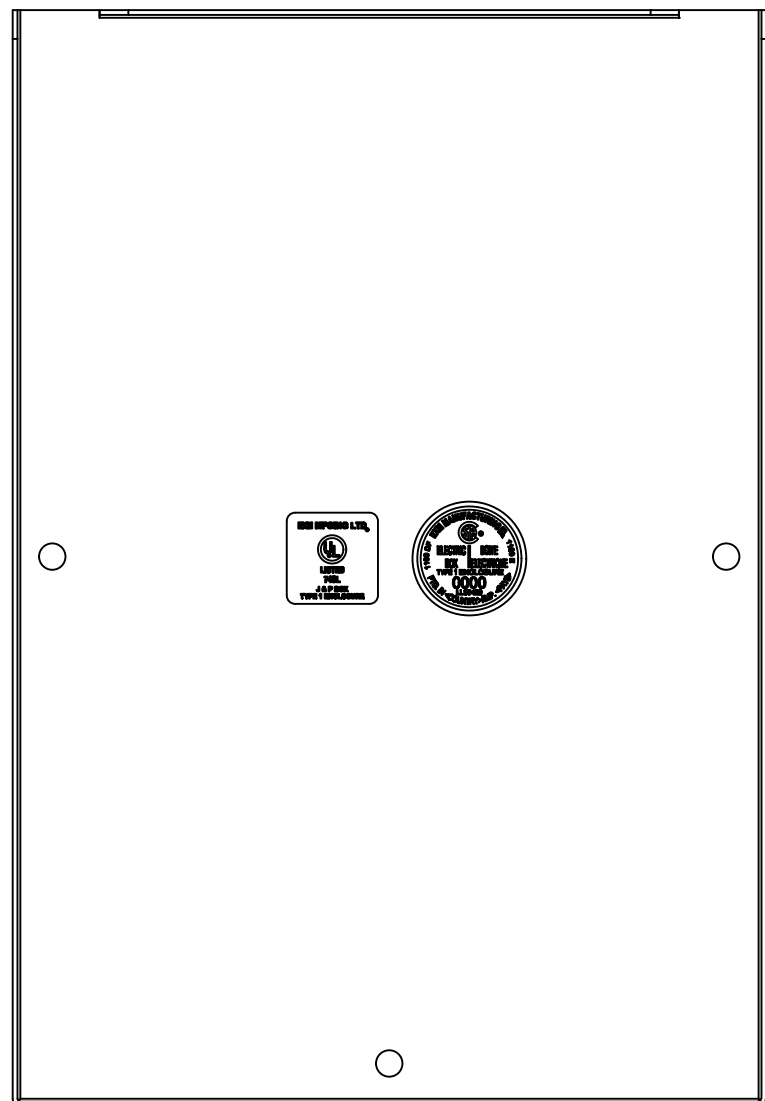

BACK

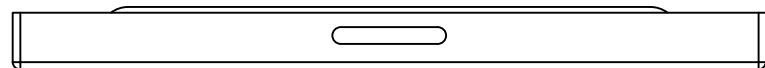

BOTTOM

0.000
0.625



LEFT

0.000
8.250
12.000

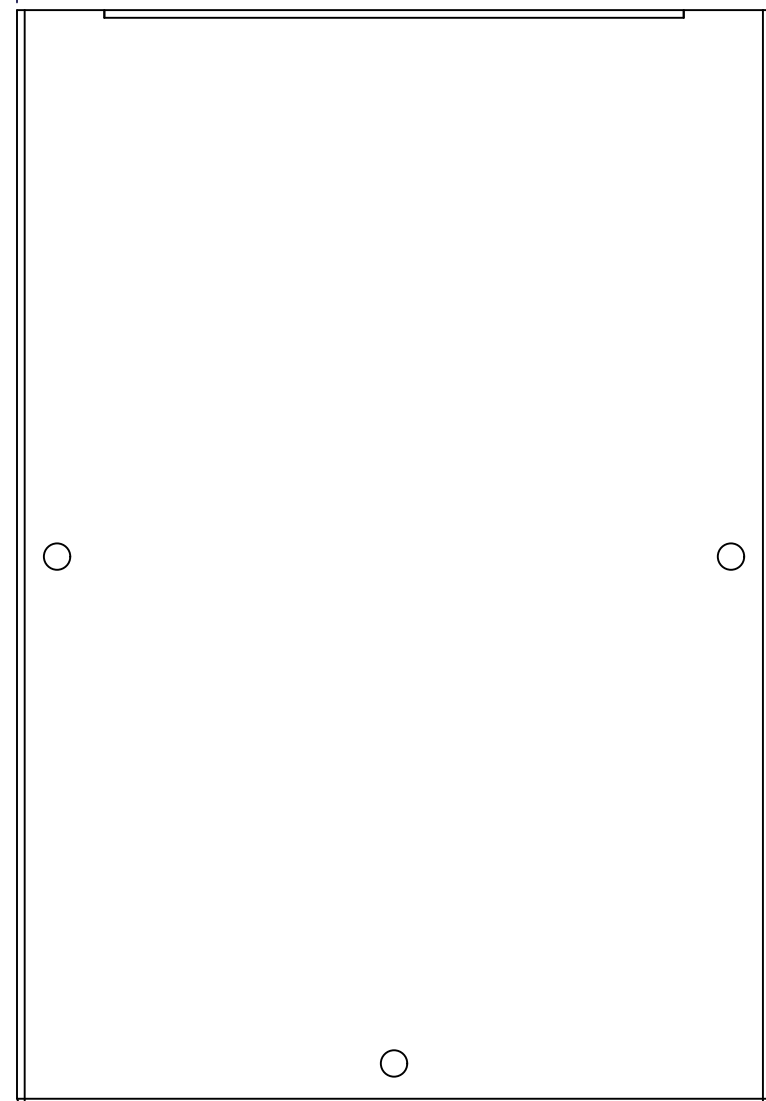

FRONT

0.000

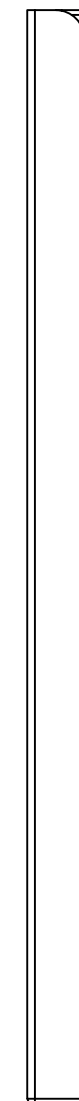

RIGHT

No.	Revisions	Date	By/Par

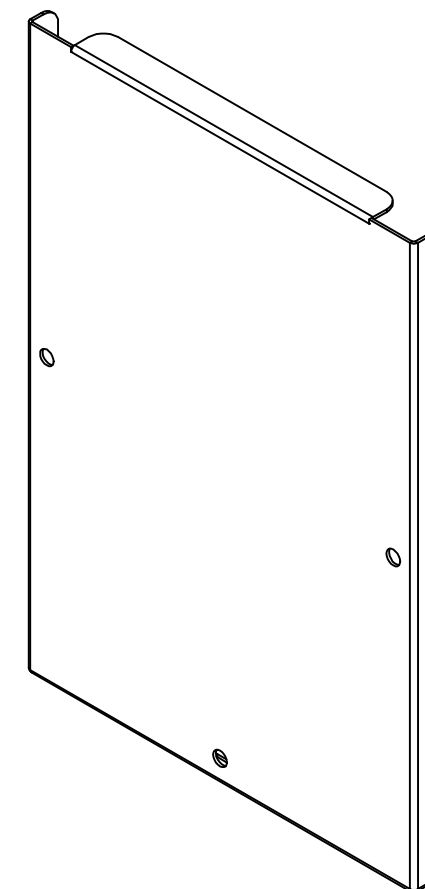

Isometric View



Tél: (450) 979-4373
Fax: (450) 979-4626
www.exmweb.com

Flatness
Aplatissement
Max 3.0mm
Projection

Customer Client	Date
Drawn By Dessiné Par BoxCad: BoxCad	Date 17-Oct-19
Material Matière 16 Ga H.R.P. & O. (1.4mm)	
Color Couleur Asa-61 Grey	Finish Fini Smooth
Description 1300 12" x 8" Cover	Detail Rev.
Part Number Numéro Pièce 1300120804C	Rev. 0

SEE BILL OF MATERIAL ON LAST PAGE

6
7

This drawing is confidential and must not be reproduced or used without the consent of EXM

Ce dessin est confidentiel et ne doit pas être reproduit ou utilisé sans le consentement de EXM

No.	Revisions	Date	By/Par

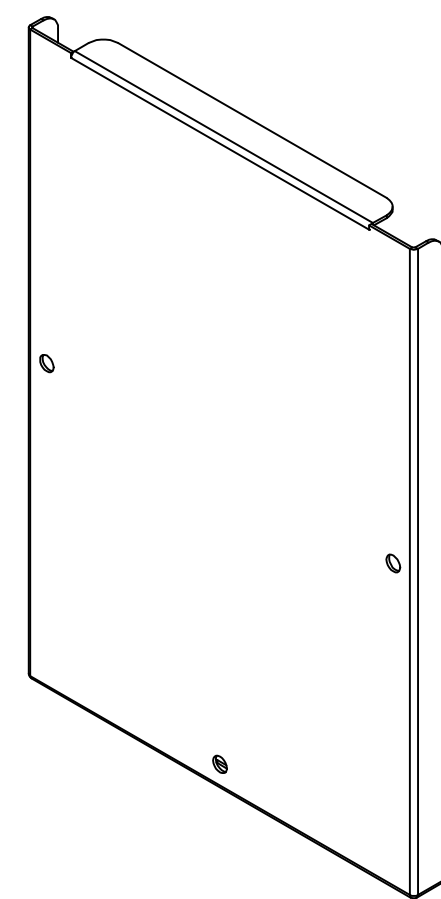

Isometric View

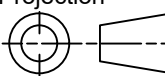

 Tél: (450) 979-4373 Fax: (450) 979-4626 www.exmweb.com		Flatness Aplatissement Max 3.0mm Projection 
Customer Client	Date	
Drawn By / Dessiné Par: BoxCad: BoxCad	Date: 17-Oct-19	
Material / Matière: 16 Ga H.R.P. & O. (1.4mm)	Color / Couleur: Asa-61 Grey	
	Finish / Fini: Smooth	
Description: 1300 12" x 8" Cover		Detail Rev.
Part Number / Numéro Pièce: 1300120804C	Rev.:	7 / 7

Qty	Part Number	Rev	Description
1	STK-S-00950	1	UL 74SL Pull-Box Sticker
1	STK-S-00800	2	CSA Electrical Box Sticker
1	STK-P-02400S	0	Powder Paint (Asa-61 Grey / Smooth)
1	1300120804C-P	0	1300 12" x 8" Cover Part
Parts List			