

This drawing is confidential and must not be reproduced or used without the consent of EXM

Ce dessin est confidentiel et ne doit pas être reproduit ou utilisé sans le consentement de EXM

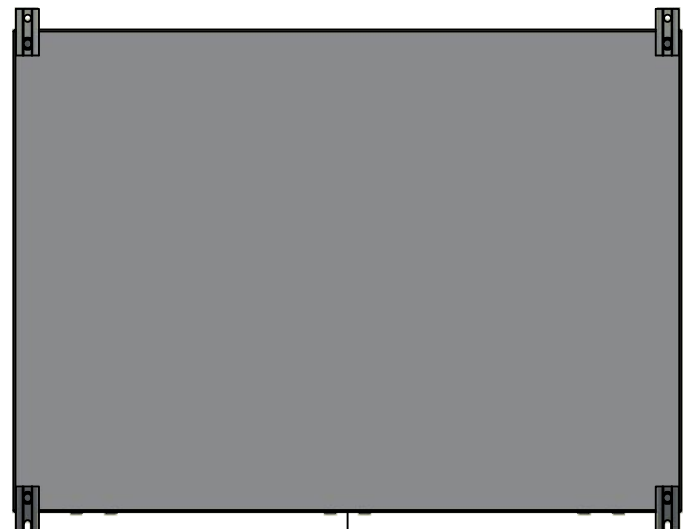

TOP



BACK

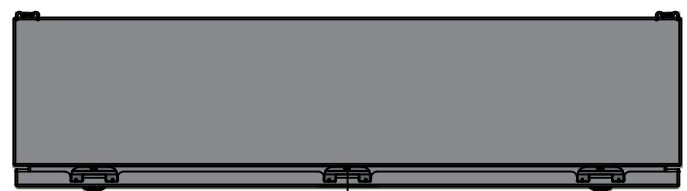

BOTTOM

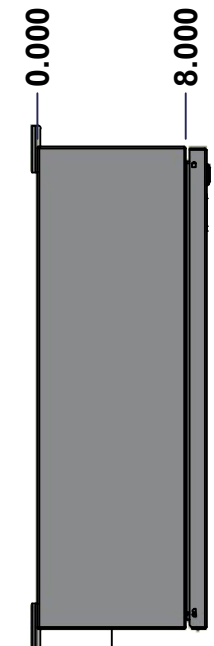

LEFT

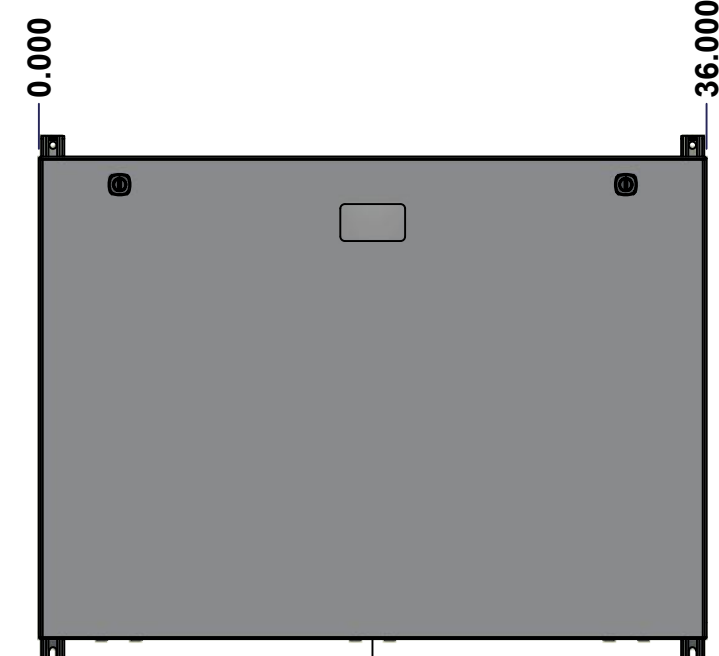

FRONT

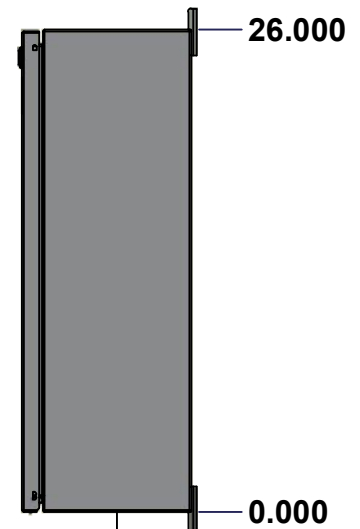

RIGHT

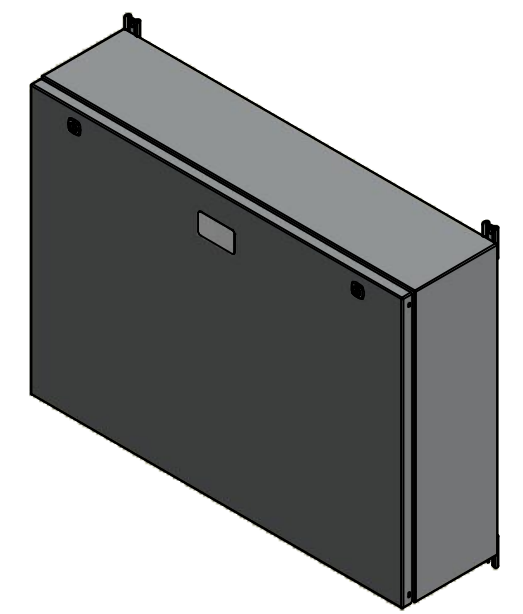

Isometric View

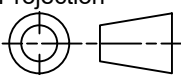

No.	Revisions	Date	By/Par

 Tél: (450) 979-4373 Fax: (450) 979-4626 www.exmweb.com		Flatness Aplatissement Max 3.0mm Projection 
Customer Client	Date	
Drawn By Dessiné Par	BoxCad: BoxCad	Date 9/30/2022
Material Matière	14 Ga Cold Rolled A1008 CS Type B (1.7mm)	
Color Couleur	Asa-61 Grey	Finish Fini Smooth
Description 1412BT 400A - 5Wires x 36" Assembly		Detail Rev.
Part Number Numéro Pièce	1412BT03405DT	Rev. 1 0

SEE BILL OF MATERIAL ON LAST PAGE

This drawing is confidential and must not be reproduced or used without the consent of Eurobox

Ce dessin est confidentiel et ne doit pas être reproduit ou utilisé sans le consentement de Eurobox

STANDARD FEATURES ARE NOT LISTED IN THIS HOLE TABLE

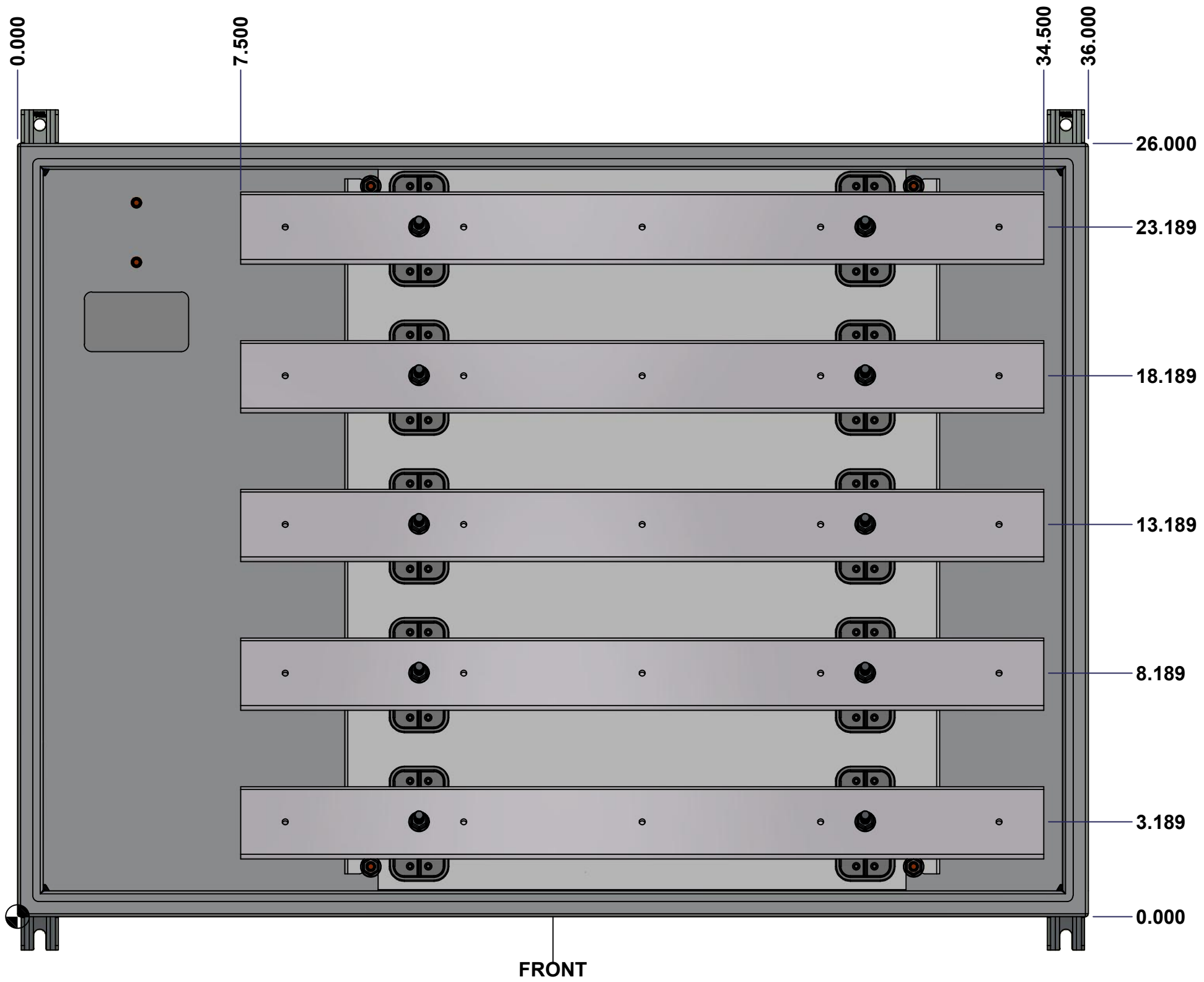

	Description	Status	
	1412BT 400A - 5Wires x 36" Assembly	(NULL)	
	Part Number	Rev.	2
	Numéro Pièce	0	16
	1412BT03405DT		

This drawing is confidential and must not be reproduced or used without the consent of EXM

Ce dessin est confidentiel et ne doit pas être reproduit ou utilisé sans le consentement de EXM

NOTE	
ITEM	DESCRIPTION
1	NEMA 4/12 Enclosure
2	C/W Standard ground studs on box and cover
3	W/O Standard door stiffener
4	C/W Special inner panel (Sold separately)
5	C/W Standard inner panel mounting studs

No.	Revisions	Date	By/Par

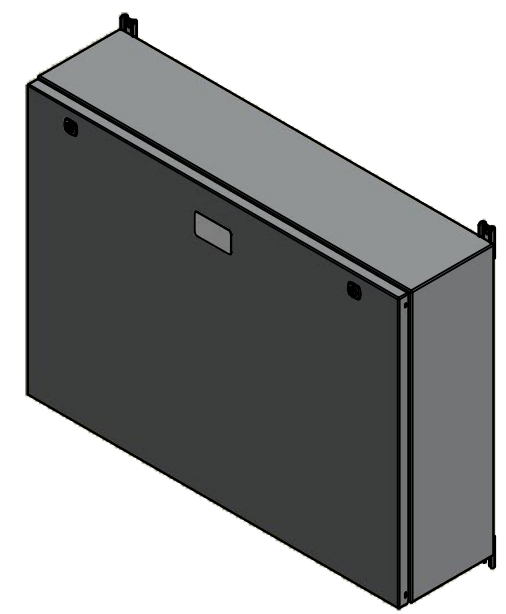

Isometric View

PACKING		
ITEM	QTY	DESCRIPTION
Cardboard sleeve	2	Top and Bottom
Cardboard strip	2	Between back of enclosure and inner panel
Plastic bag	1	To protect cover surface and inside gasket
Cardboard corner	4	To reinforced for the plastic strap tightening
Plastic strap - Black	2	To Squeeze 2 cardboard sleeve together
Packaging label	3	White label with PN
Plastic strap- Green	2	To secure the enclosure to the wood pallet
Wood Pallet	1	2" deeper and 3" larger than enclosure size

Qty	Part Number	Rev	Description
1	885 ESMF1	0	885 ESMF1 Mounting Feet Kit
1	1412BT03405DTBAR4-P	0	Rounded Edge Aluminum Bar 1/4" x 2 1/2"
1	1412BT03405DTBAR1-P	0	Rounded Edge Aluminum Bar 1/4" x 2 1/2"
1	1412BT03405DTBAR2-P	0	Rounded Edge Aluminum Bar 1/4" x 2 1/2"
1	1412BT03405DTBAR3-P	0	Rounded Edge Aluminum Bar 1/4" x 2 1/2"
1	1412BT03405DTBAR5-P	0	Rounded Edge Aluminum Bar 1/4" x 2 1/2"
1	1412BT03405DTIP1	0	1412BT 24.625" x 20" Inner Panel
10	STK-A-67400	0	Buss Bar Insulator Kit
1	STK-K-01800	5	5412 ES Accessory Kit
3	STK-Q-04050-07	7	M6 x 7mm Hexagon Socket Head Machine Screw with Nyseal
14	STK-Q-07310	2	Flange Lock Nut M8
4	STK-Q-07610	8	M8 Plastic Spacer 22.2mm
1	1412BT03405DTB	0	1412BT 26" x 36" x 8" Body
1	1412BT03405DTC	0	1412BT 26" x 36" Cover
Parts List			



Tél: (450) 979-4373
Fax: (450) 979-4626
www.exmweb.com

Flatness
Aplatissement
Max 3.0mm

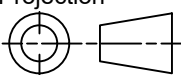
Projection

Customer Client	Date
Drawn By Dessiné Par BoxCad: BoxCad	Date 9/30/2022
Material Matière 14 Ga Cold Rolled A1008 CS Type B (1.7mm)	
Color Couleur Asa-61 Grey	Finish Fini Smooth
Description 1412BT 400A - 5Wires x 36" Assembly	
Part Number Numéro Pièce 1412BT03405DT	Rev. 0

3	16
---	----

This drawing is confidential and must not be reproduced or used without the consent of EXM

Ce dessin est confidentiel et ne doit pas être reproduit ou utilisé sans le consentement de EXM



TOP



BACK

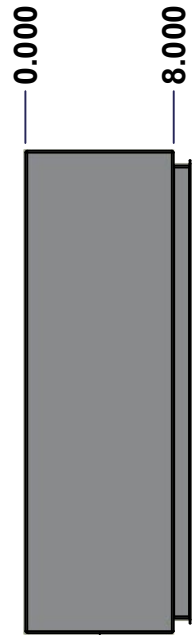

LEFT

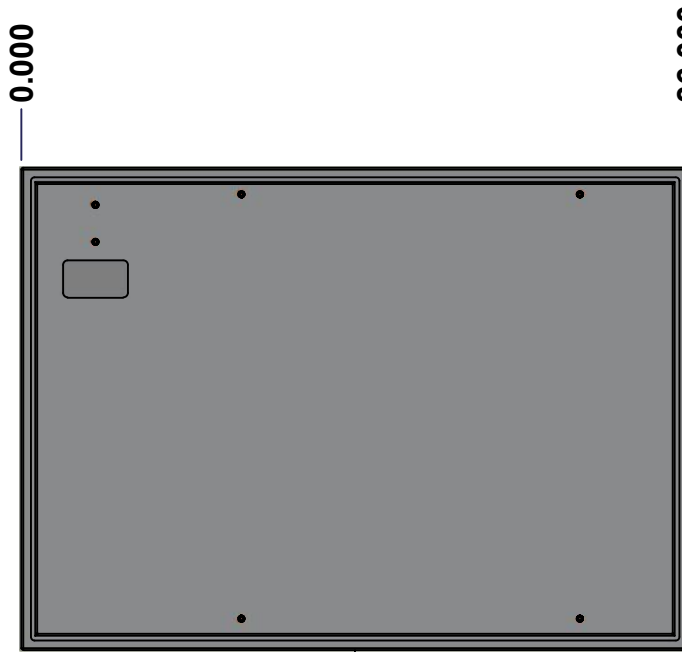

FRONT

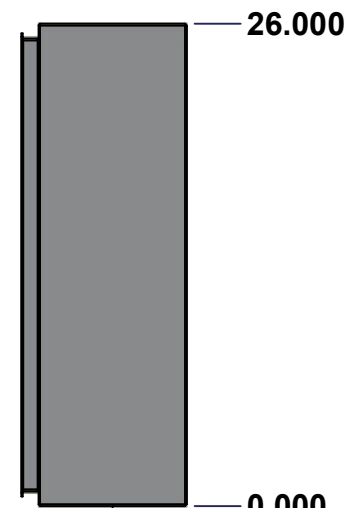

RIGHT

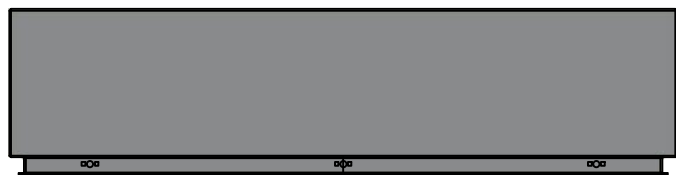

BOTTOM

No.	Revisions	Date	By/Par

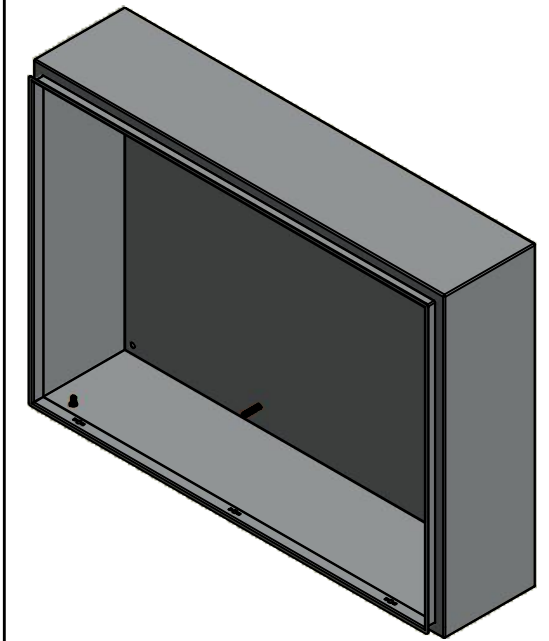

Isometric View

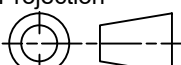

 Tél: (450) 979-4373
 Fax: (450) 979-4626
www.exmweb.com

Flatness / Aplatissement: Max 3.0mm
 Projection: 

Customer Client	Date
Drawn By / Dessiné Par: BoxCad: BoxCad	Date: 9/30/2022
Material / Matière: 14 Ga Cold Rolled A1008 CS Type B (1.7mm)	
Color / Couleur: Asa-61 Grey	Finish / Fini: Smooth

Description: 1412BT 26" x 36" x 8" Body	Detail Rev.
Part Number / Numéro Pièce: 1412BT03405DTB	Rev. 4

SEE BILL OF MATERIAL ON LAST PAGE

Rev. 0	4	16
--------	---	----

This drawing is confidential and must not be reproduced or used without the consent of Eurobox

Ce dessin est confidentiel et ne doit pas être reproduit ou utilisé sans le consentement de Eurobox

STANDARD FEATURES ARE NOT LISTED IN THIS HOLE TABLE

HOLE TABLE - BACK VIEW (CUSTOM FEATURE ONLY)

CUT-OUT	XDIM	YDIM	DESCRIPTION
1	32.000	24.000	GND STUD M8 x 35mm (Inside)
2	32.000	22.000	GND STUD M8 x 35mm (Inside)
3	5.875	24.563	IP STUD M8 x 35mm (Inside)
4	24.125	24.563	IP STUD M8 x 35mm (Inside)
5	5.875	1.688	IP STUD M8 x 35mm (Inside)
6	24.125	1.688	IP STUD M8 x 35mm (Inside)

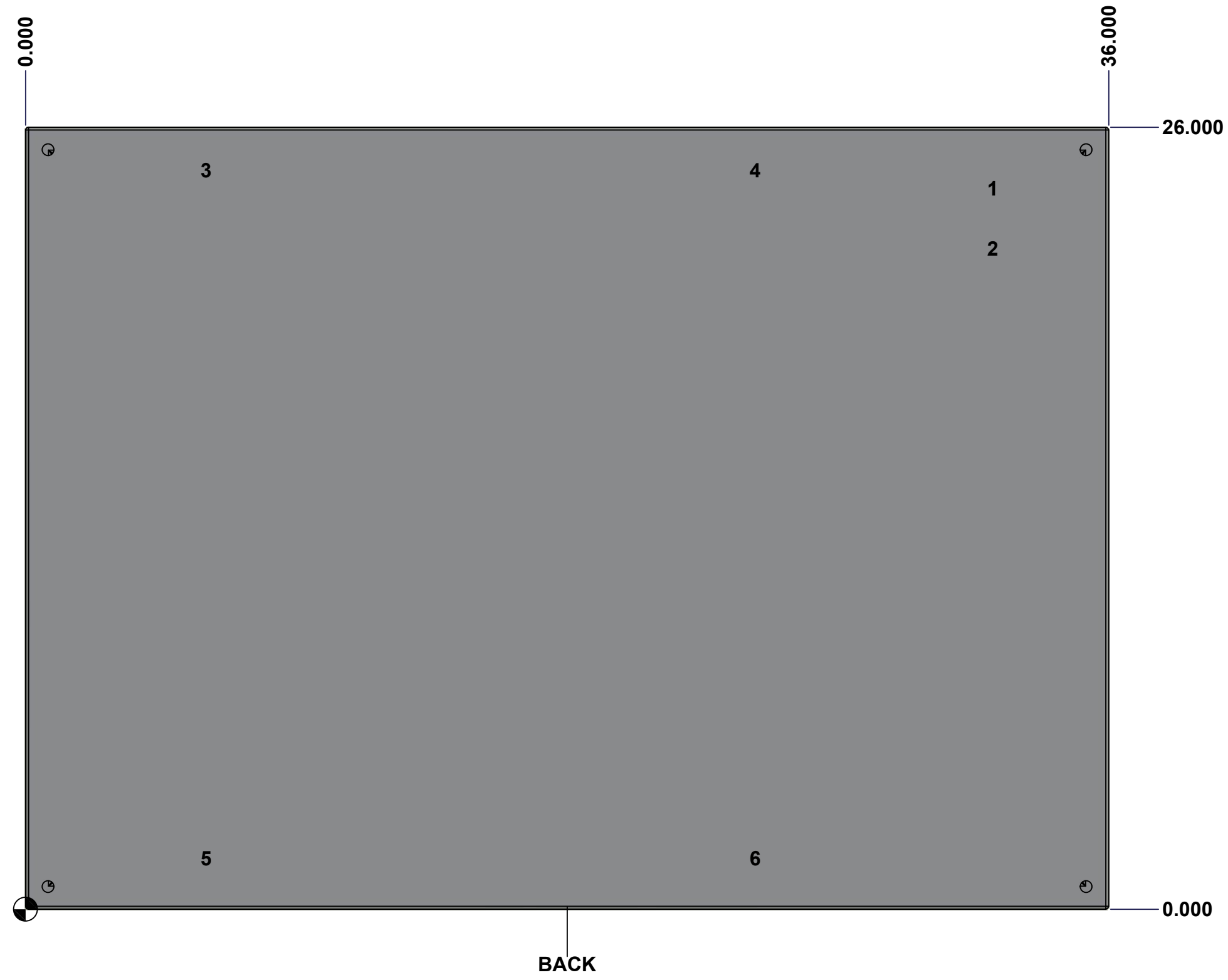



	Description	Status
	1412BT 26" x 36" x 8" Body	(NULL)
Part Number Numéro Pièce	1412BT03405DTB	Rev.
		5
		16

This drawing is confidential and must not be reproduced or used without the consent of EXM

Ce dessin est confidentiel et ne doit pas être reproduit ou utilisé sans le consentement de EXM

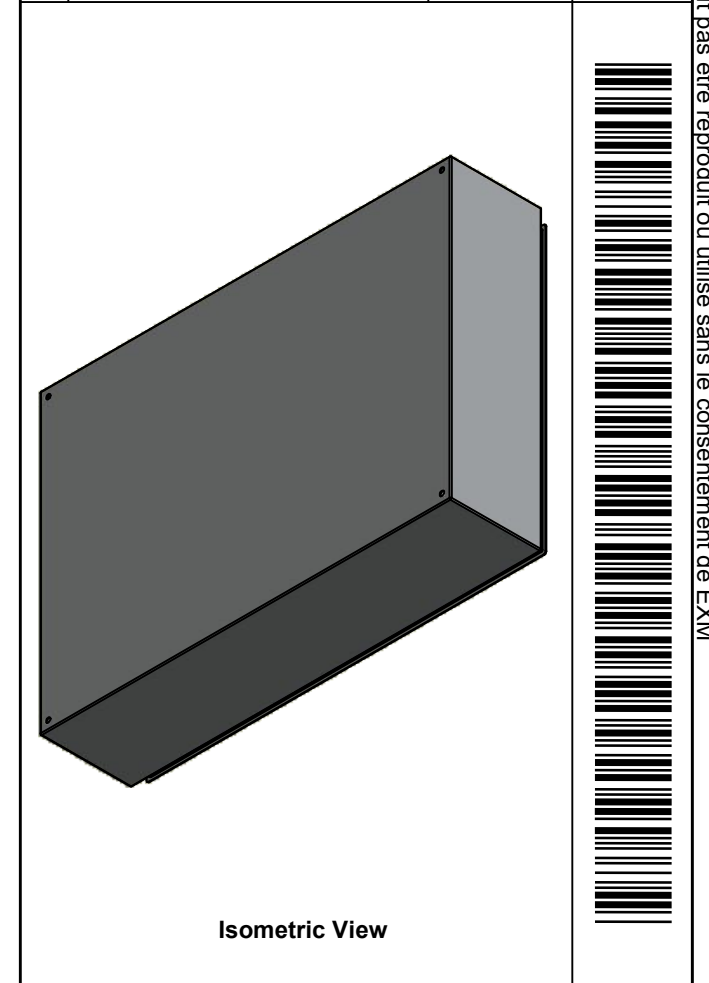
No.	Revisions	Date	By/Par



 Tél: (450) 979-4373 Fax: (450) 979-4626 www.exmweb.com		Flatness Aplatissement Max 3.0mm
Customer Client		Date
Drawn By / Dessiné Par: BoxCad: BoxCad		Date: 9/30/2022
Material / Matière: 14 Ga Cold Rolled A1008 CS Type B (1.7mm)		
Color / Couleur: Asa-61 Grey	Finish / Fini: Smooth	
Description: 1412BT 26" x 36" x 8" Body		Detail Rev.
Part Number / Numéro Pièce: 1412BT03405DTB		Rev. 6 0

Qty	Part Number	Rev	Description
1	STK-P-02400S	0	Powder Paint (Asa-61 Grey / Smooth)
6	STK-Q-16005	1	Stud M8 x 35 (No Paint Cap Required)
1	STK-Q-16080	0	Ground Stud M6 x 16mm
1	STK-S-00100	0	3.5" x 2" Silver Milar Flexcon Sticker
1	1412BT03405DTB-P	0	1412BT 26" x 36" x 8" Body Part
Parts List			

This drawing is confidential and must not be reproduced or used without the consent of Eurobox

Ce dessin est confidentiel et ne doit pas être reproduit ou utilisé sans le consentement de Eurobox

STANDARD FEATURES ARE NOT LISTED IN THIS HOLE TABLE

HOLE TABLE - FRONT VIEW (CUSTOM FEATURE ONLY)

CUT-OUT	XDIM	YDIM	DESCRIPTION
1	25.500	1.250	RND Ø0.201 THREAD 1/4-20 UNC
2	19.500	1.250	RND Ø0.201 THREAD 1/4-20 UNC
3	13.500	1.250	RND Ø0.201 THREAD 1/4-20 UNC
4	7.500	1.250	RND Ø0.201 THREAD 1/4-20 UNC
5	1.500	1.250	RND Ø0.201 THREAD 1/4-20 UNC

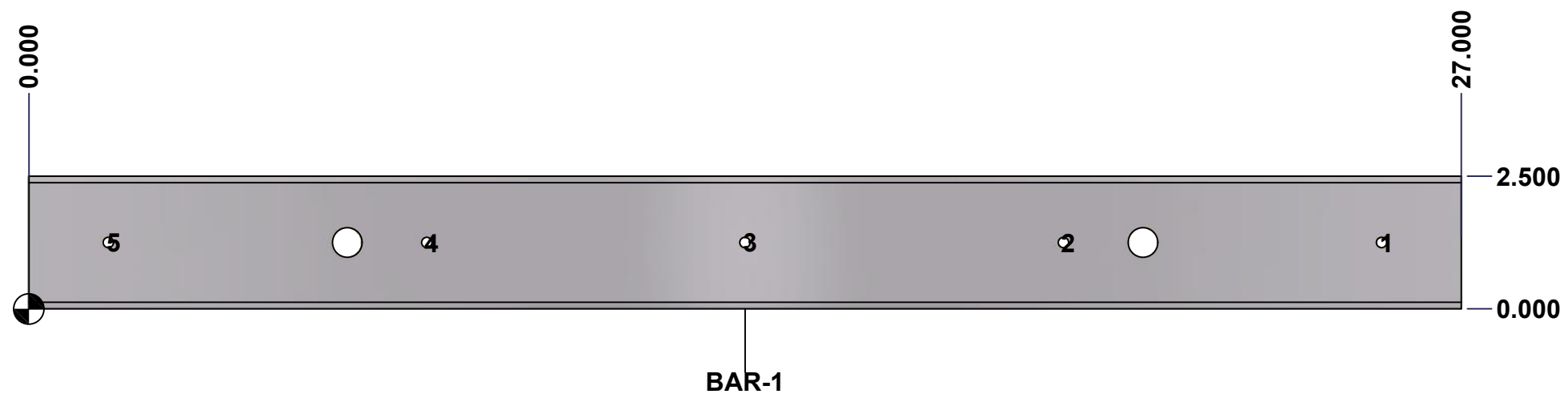

	Description	Status
	Rounded Edge Aluminum Bar 1/4" x 2 1/2"	(NULL)
	Part Number Numéro Pièce	Rev.
	1412BT03405DTBAR1-P	0 / 7
		16

This drawing is confidential and must not be reproduced or used without the consent of Eurobex

Ce dessin est confidentiel et ne doit pas être reproduit ou utilisé sans le consentement de Eurobex

STANDARD FEATURES ARE NOT LISTED IN THIS HOLE TABLE

HOLE TABLE - FRONT VIEW (CUSTOM FEATURE ONLY)

CUT-OUT	XDIM	YDIM	DESCRIPTION
1	25.500	1.250	RND Ø0.201 THREAD 1/4-20 UNC
2	19.500	1.250	RND Ø0.201 THREAD 1/4-20 UNC
3	13.500	1.250	RND Ø0.201 THREAD 1/4-20 UNC
4	7.500	1.250	RND Ø0.201 THREAD 1/4-20 UNC
5	1.500	1.250	RND Ø0.201 THREAD 1/4-20 UNC

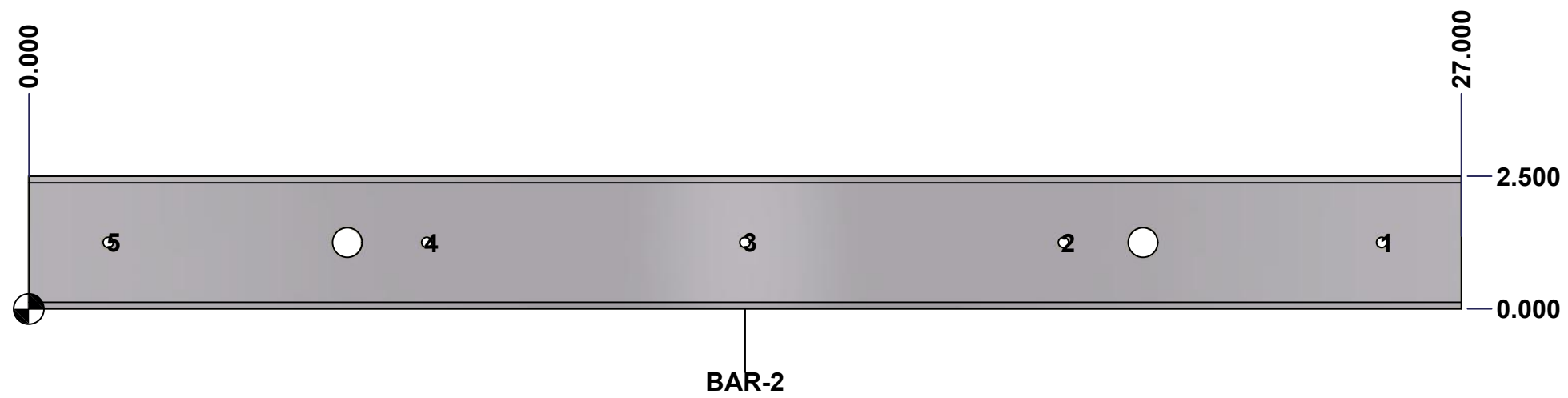

	Description		Status
	Rounded Edge Aluminum Bar 1/4" x 2 1/2"		(NULL)
Part Number Numéro Pièce		Rev.	8
1412BT03405DTBAR2-P		0	16

This drawing is confidential and must not be reproduced or used without the consent of Eurobex

Ce dessin est confidentiel et ne doit pas être reproduit ou utilisé sans le consentement de Eurobex

STANDARD FEATURES ARE NOT LISTED IN THIS HOLE TABLE

HOLE TABLE - FRONT VIEW (CUSTOM FEATURE ONLY)

CUT-OUT	XDIM	YDIM	DESCRIPTION
1	25.500	1.250	RND Ø0.201 THREAD 1/4-20 UNC
2	19.500	1.250	RND Ø0.201 THREAD 1/4-20 UNC
3	13.500	1.250	RND Ø0.201 THREAD 1/4-20 UNC
4	7.500	1.250	RND Ø0.201 THREAD 1/4-20 UNC
5	1.500	1.250	RND Ø0.201 THREAD 1/4-20 UNC

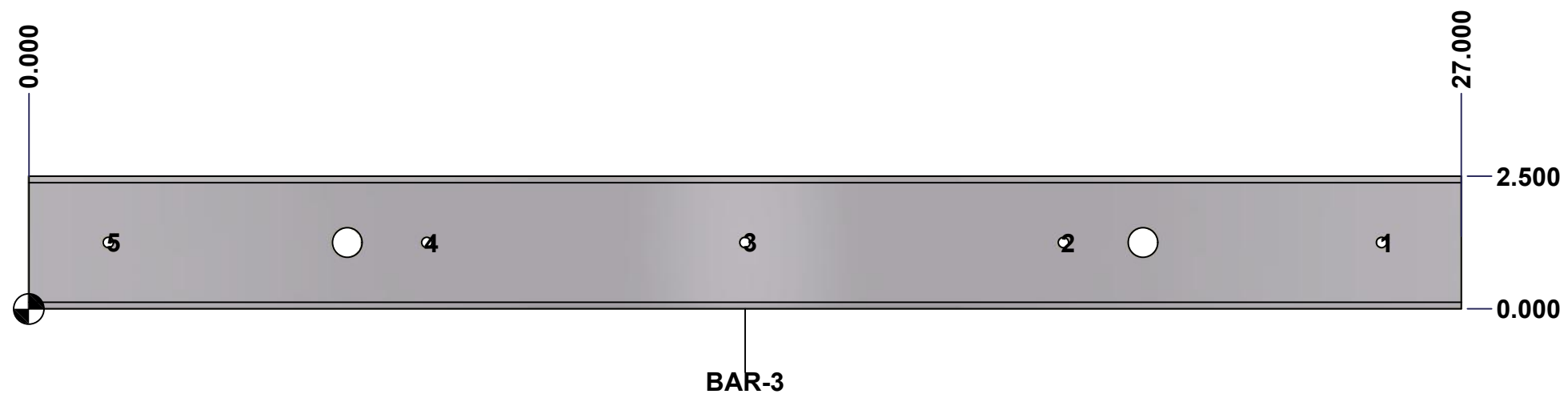

	Description	Status
	Rounded Edge Aluminum Bar 1/4" x 2 1/2"	(NULL)
	Part Number	Rev.
	Numéro Pièce	9
	1412BT03405DTBAR3-P	0
		16

This drawing is confidential and must not be reproduced or used without the consent of Eurobex

Ce dessin est confidentiel et ne doit pas être reproduit ou utilisé sans le consentement de Eurobex

STANDARD FEATURES ARE NOT LISTED IN THIS HOLE TABLE			
HOLE TABLE - FRONT VIEW (CUSTOM FEATURE ONLY)			
CUT-OUT	XDIM	YDIM	DESCRIPTION
1	25.500	1.250	RND Ø0.201 THREAD 1/4-20 UNC
2	19.500	1.250	RND Ø0.201 THREAD 1/4-20 UNC
3	13.500	1.250	RND Ø0.201 THREAD 1/4-20 UNC
4	7.500	1.250	RND Ø0.201 THREAD 1/4-20 UNC
5	1.500	1.250	RND Ø0.201 THREAD 1/4-20 UNC

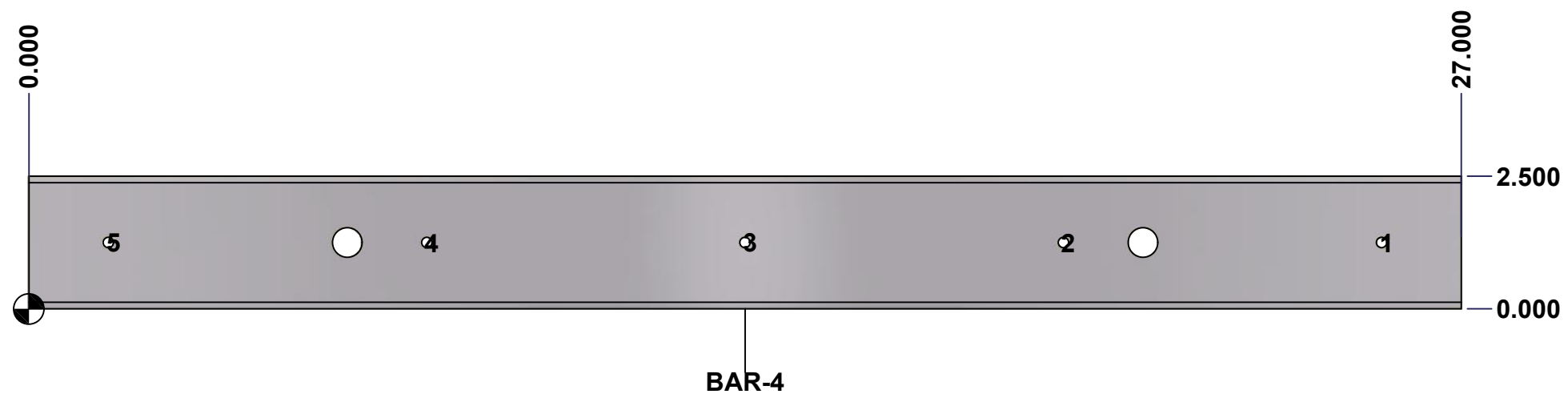

	Description	Status	
	Rounded Edge Aluminum Bar 1/4" x 2 1/2"	(NULL)	
	Part Number Numéro Pièce	Rev.	
	1412BT03405DTBAR4-P	0	10 16

This drawing is confidential and must not be reproduced or used without the consent of Eurobex

Ce dessin est confidentiel et ne doit pas être reproduit ou utilisé sans le consentement de Eurobex

STANDARD FEATURES ARE NOT LISTED IN THIS HOLE TABLE			
HOLE TABLE - FRONT VIEW (CUSTOM FEATURE ONLY)			
CUT-OUT	XDIM	YDIM	DESCRIPTION
1	25.500	1.250	RND Ø0.201 THREAD 1/4-20 UNC
2	19.500	1.250	RND Ø0.201 THREAD 1/4-20 UNC
3	13.500	1.250	RND Ø0.201 THREAD 1/4-20 UNC
4	7.500	1.250	RND Ø0.201 THREAD 1/4-20 UNC
5	1.500	1.250	RND Ø0.201 THREAD 1/4-20 UNC

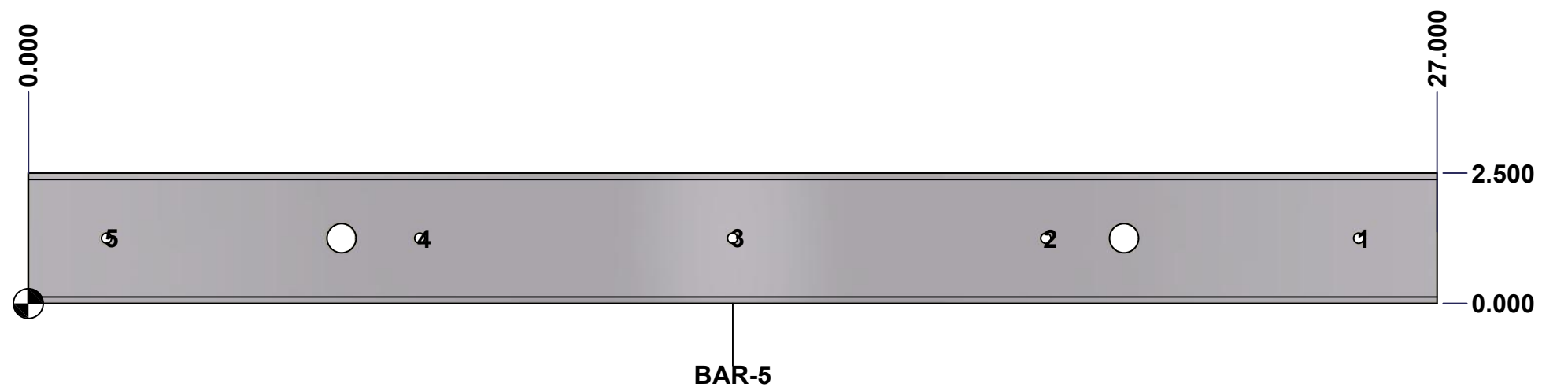

	Description	Status
	Rounded Edge Aluminum Bar 1/4" x 2 1/2"	(NULL)
	Part Number Numéro Pièce	Rev.
	1412BT03405DTBAR5-P	0
		11
		16

This drawing is confidential and must not be reproduced or used without the consent of EXM

Ce dessin est confidentiel et ne doit pas être reproduit ou utilisé sans le consentement de EXM



TOP

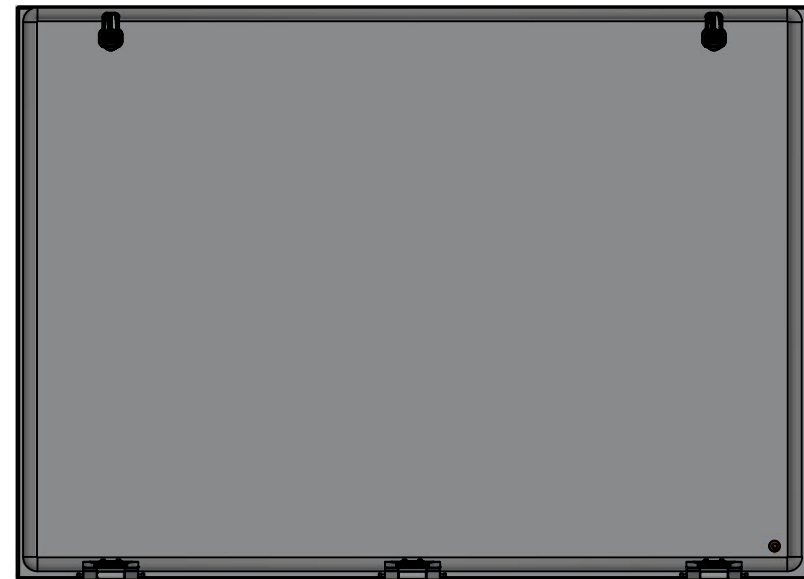

BACK

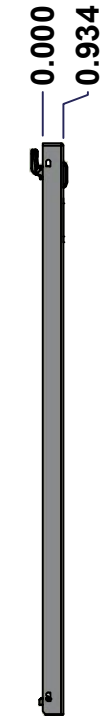

LEFT

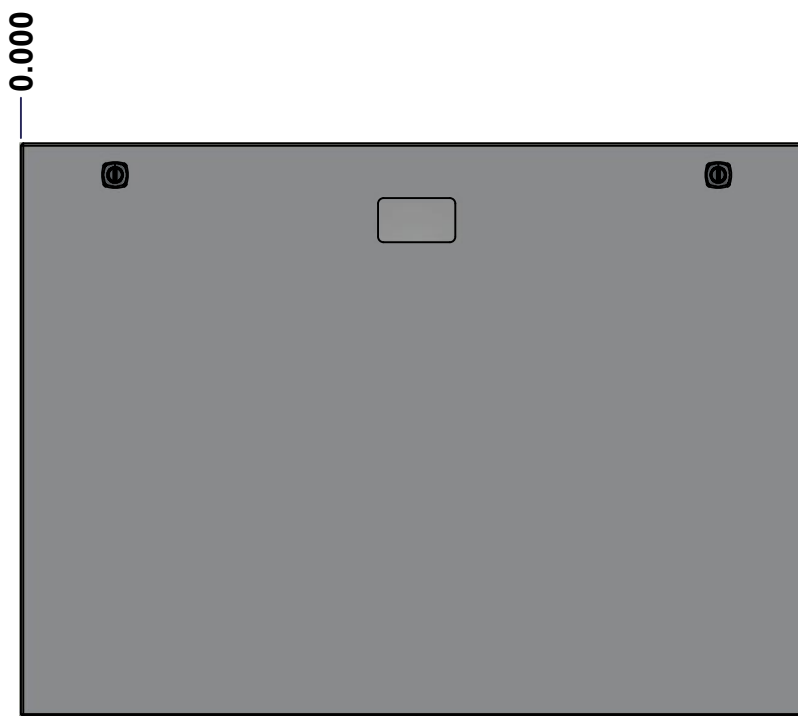

FRONT

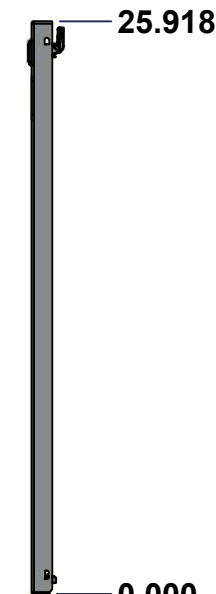

RIGHT



BOTTOM

No.	Revisions	Date	By/Par

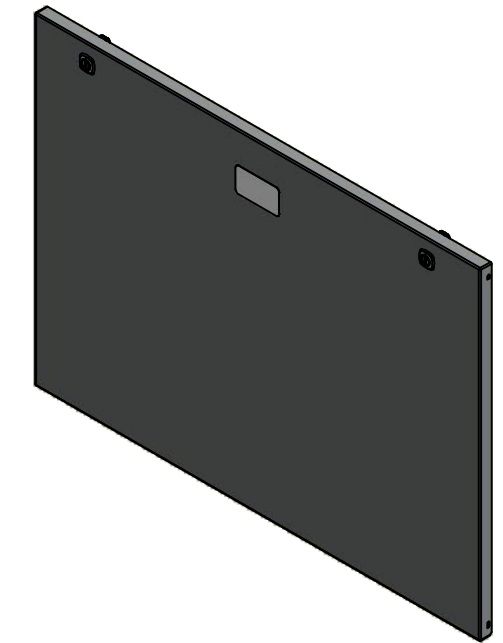

Isometric View



Tél: (450) 979-4373
 Fax: (450) 979-4626
www.exmweb.com

Flatness
Aplatissement

Max 3.0mm

Projection



Customer Client	Date
Drawn By / Dessiné Par: BoxCad: BoxCad	Date: 9/30/2022
Material / Matière: 14 Ga Cold Rolled A1008 CS Type B (1.7mm)	

Color / Couleur: Asa-61 Grey	Finish / Fini: Smooth
------------------------------	-----------------------

Description: 1412BT 26" x 36" Cover	Detail Rev.
-------------------------------------	-------------

Part Number / Numéro Pièce: 1412BT03405DTC	Rev. 0	12 / 16
--	--------	---------

SEE BILL OF MATERIAL ON LAST PAGE

This drawing is confidential and must not be reproduced or used without the consent of Eurobox

Ce dessin est confidentiel et ne doit pas être reproduit ou utilisé sans le consentement de Eurobox

STANDARD FEATURES ARE NOT LISTED IN THIS HOLE TABLE			
HOLE TABLE - FRONT VIEW (CUSTOM FEATURE ONLY)			
CUT-OUT	XDIM	YDIM	DESCRIPTION
1	1.500	1.486	GND STUD M6 x 16mm (Inside)
2	31.553	24.494	LOCK 880 SCQ4-SL @ 90.0°
3	4.250	24.494	LOCK 880 SCQ4-SL @ 90.0°

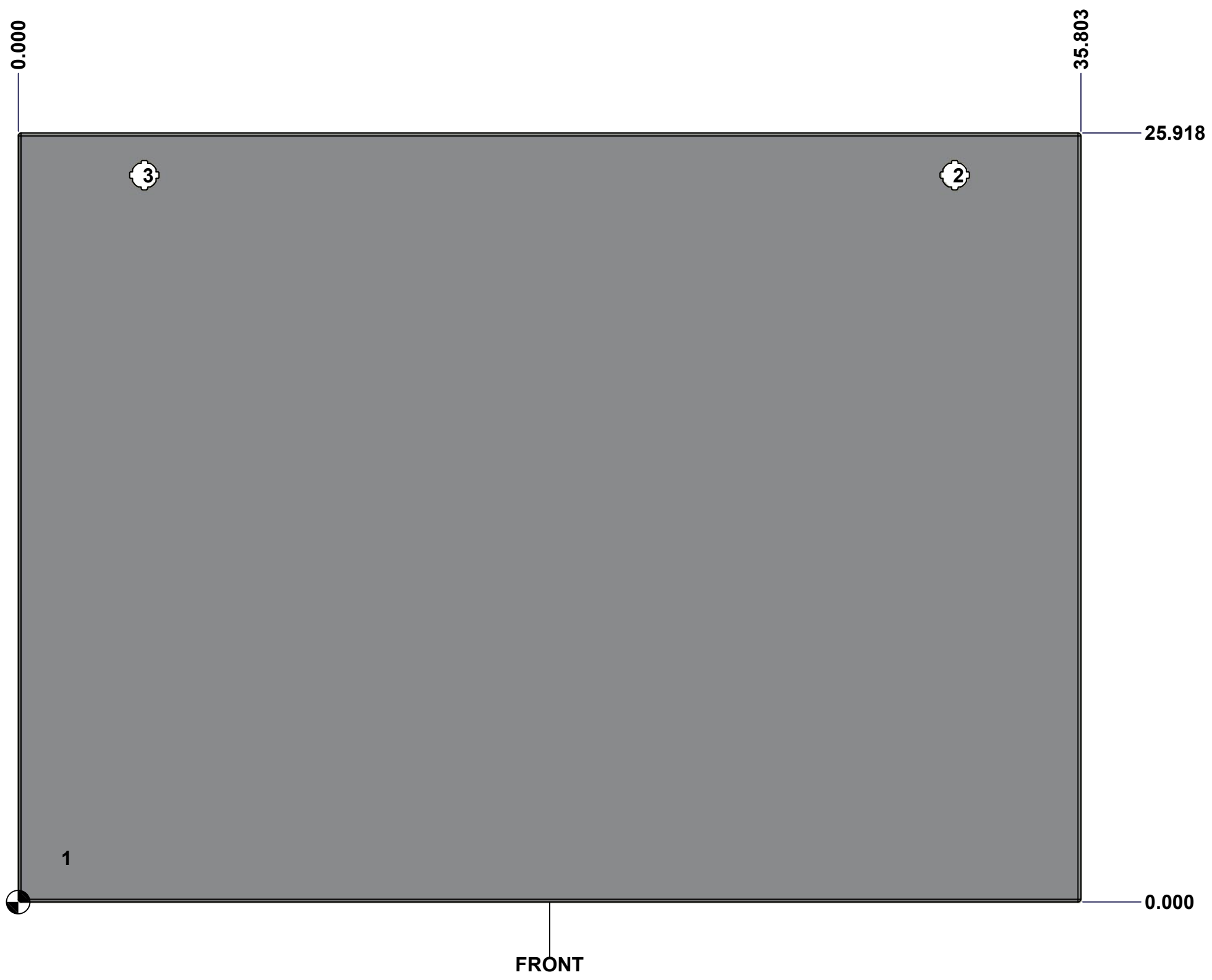

	Description	Status	
	1412BT 26" x 36" Cover	(NULL)	
	Part Number Numéro Pièce	Rev.	
	1412BT03405DTC	0	13 16

This drawing is confidential and must not be reproduced or used without the consent of EXM

Ce dessin est confidentiel et ne doit pas être reproduit ou utilisé sans le consentement de EXM

No.	Revisions	Date	By/Par

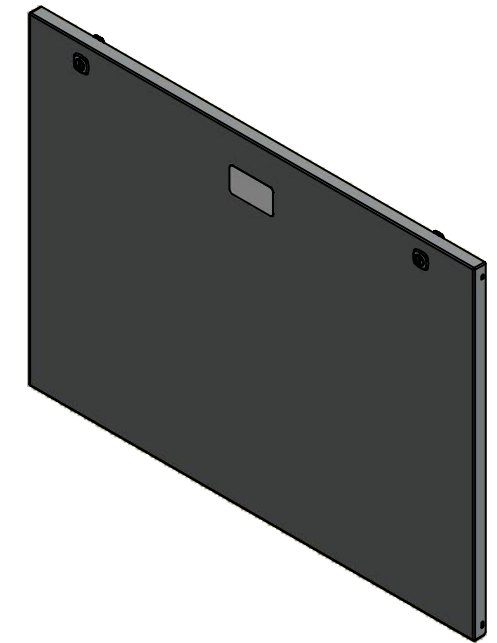

Isometric View



Tél: (450) 979-4373
 Fax: (450) 979-4626
www.exmweb.com

Flatness
Aplatissement

Max 3.0mm

Projection

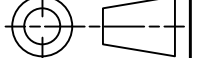

Customer Client	Date
Drawn By / Dessiné Par: BoxCad: BoxCad	Date: 9/30/2022
Material / Matière: 14 Ga Cold Rolled A1008 CS Type B (1.7mm)	

Color / Couleur: Asa-61 Grey	Finish / Fini: Smooth
------------------------------	-----------------------

Description: 1412BT 26" x 36" Cover	Detail Rev.
-------------------------------------	-------------

Part Number / Numéro Pièce: 1412BT03405DTC	Rev. 0	14
---	--------	----

Qty	Part Name	Rev	Description
1	1412BT03405DTG	0	1412BT 26" x 36" Cover Gasket
1	STK-P-02400S	0	Powder Paint (Asa-61 Grey / Smooth)
3	STK-K-09800	10	5412 ES Hinge with 2 Captive Hinge Pins
1	STK-Q-16080	0	Ground Stud M6 x 16mm
1	STK-S-00100	0	3.5" x 2" Silver Milar Flexcon Sticker
1	1412BT03405DTC-P	0	1412BT 26" x 36" Cover Part
2	880 SCQ4-SL	6	5412 ES 1/4 Turn Lock
Parts List			

This drawing is confidential and must not be reproduced or used without the consent of EXM

Ce dessin est confidentiel et ne doit pas être reproduit ou utilisé sans le consentement de EXM

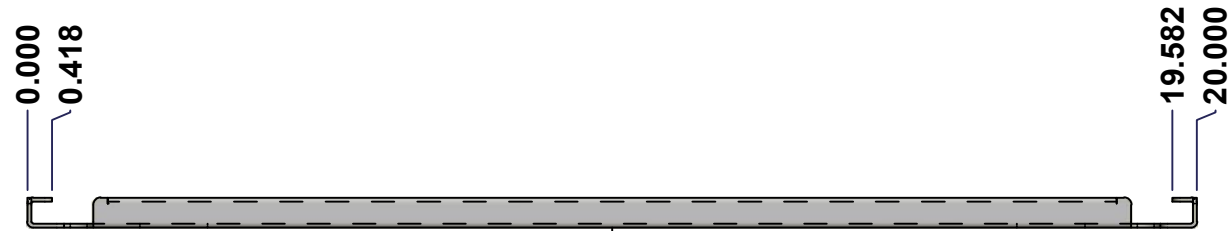

TOP

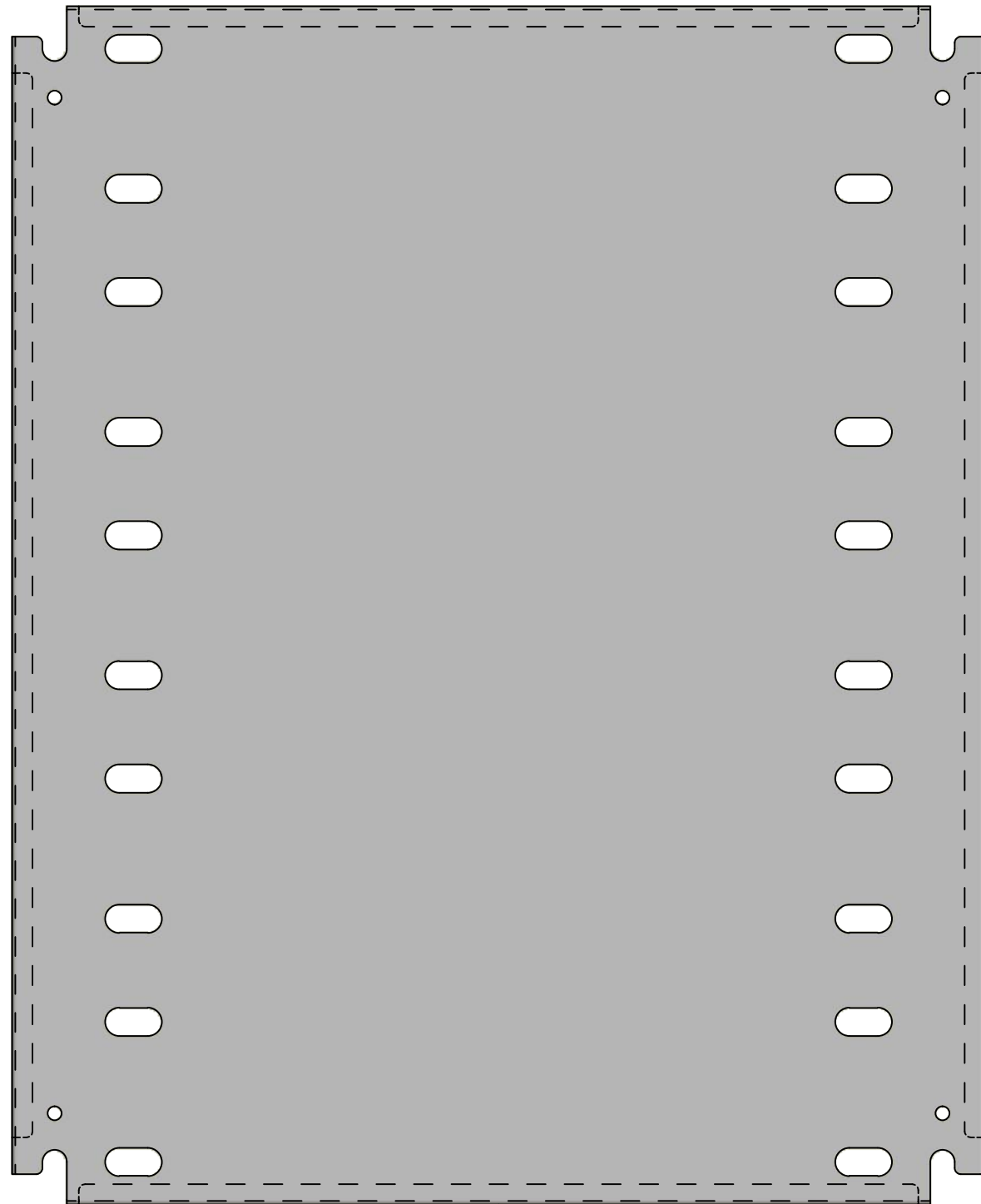

FRONT

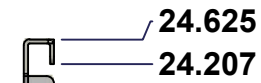

RIGHT



SEE BILL OF MATERIAL ON LAST PAGE

No.	Revisions	Date	By/Par

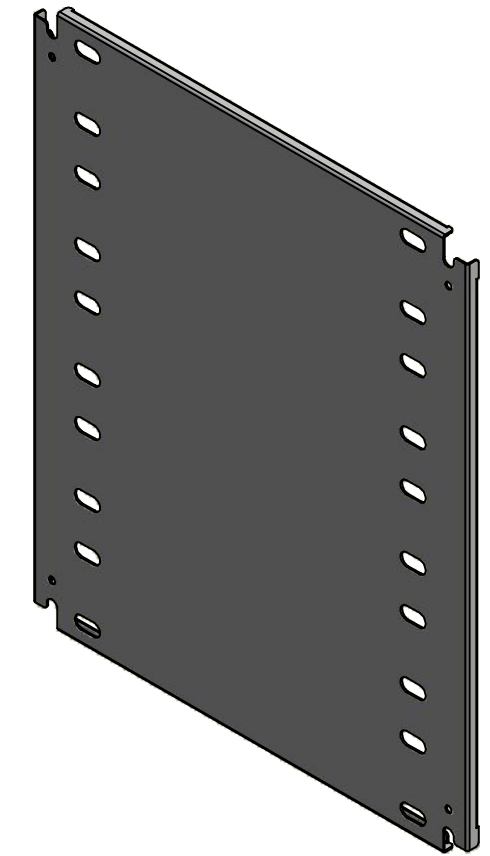

Isometric View



Tél: (450) 979-4373
 Fax: (450) 979-4626
www.exmweb.com

Flatness
Aplatissement

Max 3.0mm

Projection

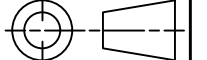

Customer Client	Date
Drawn By Dessiné Par BoxCad: BoxCad	Date 9/30/2022
Material Matière 14 Ga Cold Rolled A1008 CS Type B (1.7mm)	

Color Couleur White RAL9003	Finish Fini Smooth
--------------------------------	-----------------------

Description 1412BT 24.625" x 20" Inner Panel	Detail Rev.
---	-------------

Part Number Numéro Pièce 1412BT03405DTIP1	Rev. 0	15 16
--	------------------	----------

This drawing is confidential and must not be reproduced or used without the consent of EXM

Ce dessin est confidentiel et ne doit pas être reproduit ou utilisé sans le consentement de EXM

No.	Revisions	Date	By/Par

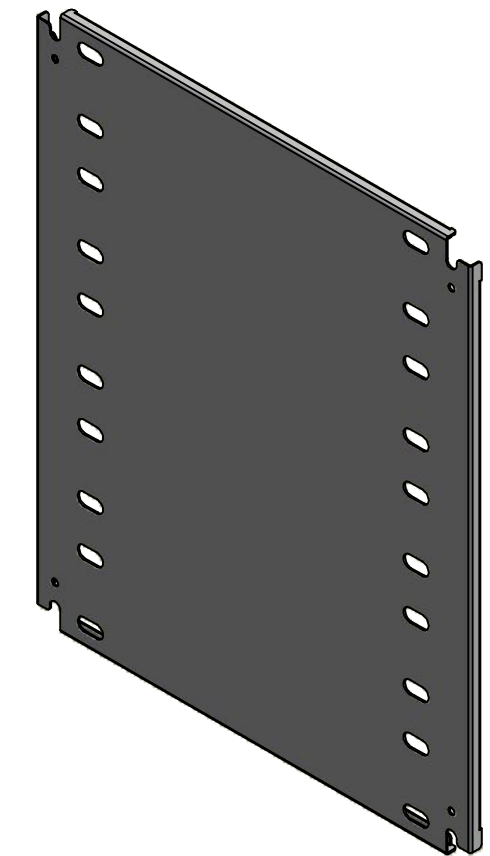

Isometric View

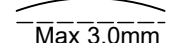

 Tél: (450) 979-4373 Fax: (450) 979-4626 www.exmweb.com		Flatness Aplatissement  Max 3.0mm
Customer Client		Date
Drawn By / Dessiné Par: BoxCad: BoxCad		Date: 9/30/2022
Material / Matière: 14 Ga Cold Rolled A1008 CS Type B (1.7mm)		
Color / Couleur: White RAL9003	Finish / Fini: Smooth	
Description: 1412BT 24.625" x 20" Inner Panel		Detail Rev.
Part Number / Numéro Pièce: 1412BT03405DTIP1		Rev. 0 / 16

Qty	Part Number	Rev	Description
1	STK-P-02401S	0	Powder Paint (White / Smooth)
1	1412BT03405DTIP1-P	0	1412BT 24.625" x 36" Inner Panel Part
Parts List			