

This drawing is confidential and must not be reproduced or used without the consent of EXM

Ce dessin est confidentiel et ne doit pas être reproduit ou utilisé sans le consentement de EXM

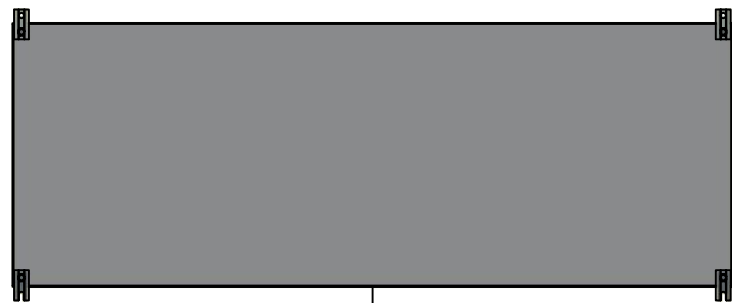

TOP



BACK

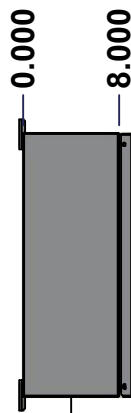

LEFT

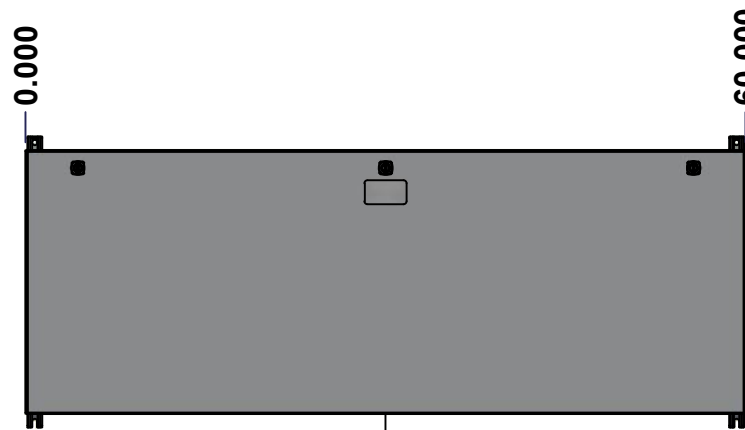

FRONT

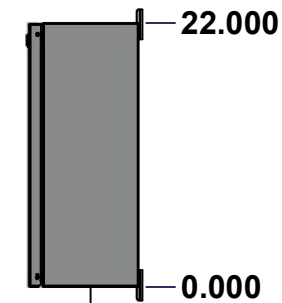

RIGHT



BOTTOM

| No. | Revisions | Date | By/Par |
|-----|-----------|------|--------|
| | | | |
| | | | |
| | | | |
| | | | |

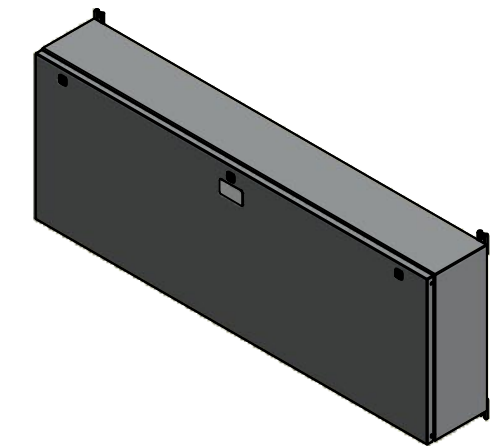

Isometric View



Tél: (450) 979-4373
 Fax: (450) 979-4626
www.exmweb.com

Flatness
Aplatissement

Max 3.0mm

Projection

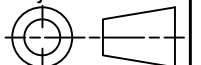

Customer Client _____ Date _____

Drawn By Dessiné Par BoxCad: BoxCad Date 30-Sep-22

Material Matière 14 Ga Cold Rolled A1008 CS Type B (1.7mm)

Color Couleur Asa-61 Grey Finish Fini Smooth

Description 1412BT 400A - 4Wires x 60" Assembly Detail Rev. _____

Part Number Numéro Pièce **1412BT05404DT** Rev. **0** 1/15

SEE BILL OF MATERIAL ON LAST PAGE

This drawing is confidential and must not be reproduced or used without the consent of Eurobox

Ce dessin est confidentiel et ne doit pas être reproduit ou utilisé sans le consentement de Eurobox

STANDARD FEATURES ARE NOT LISTED IN THIS HOLE TABLE

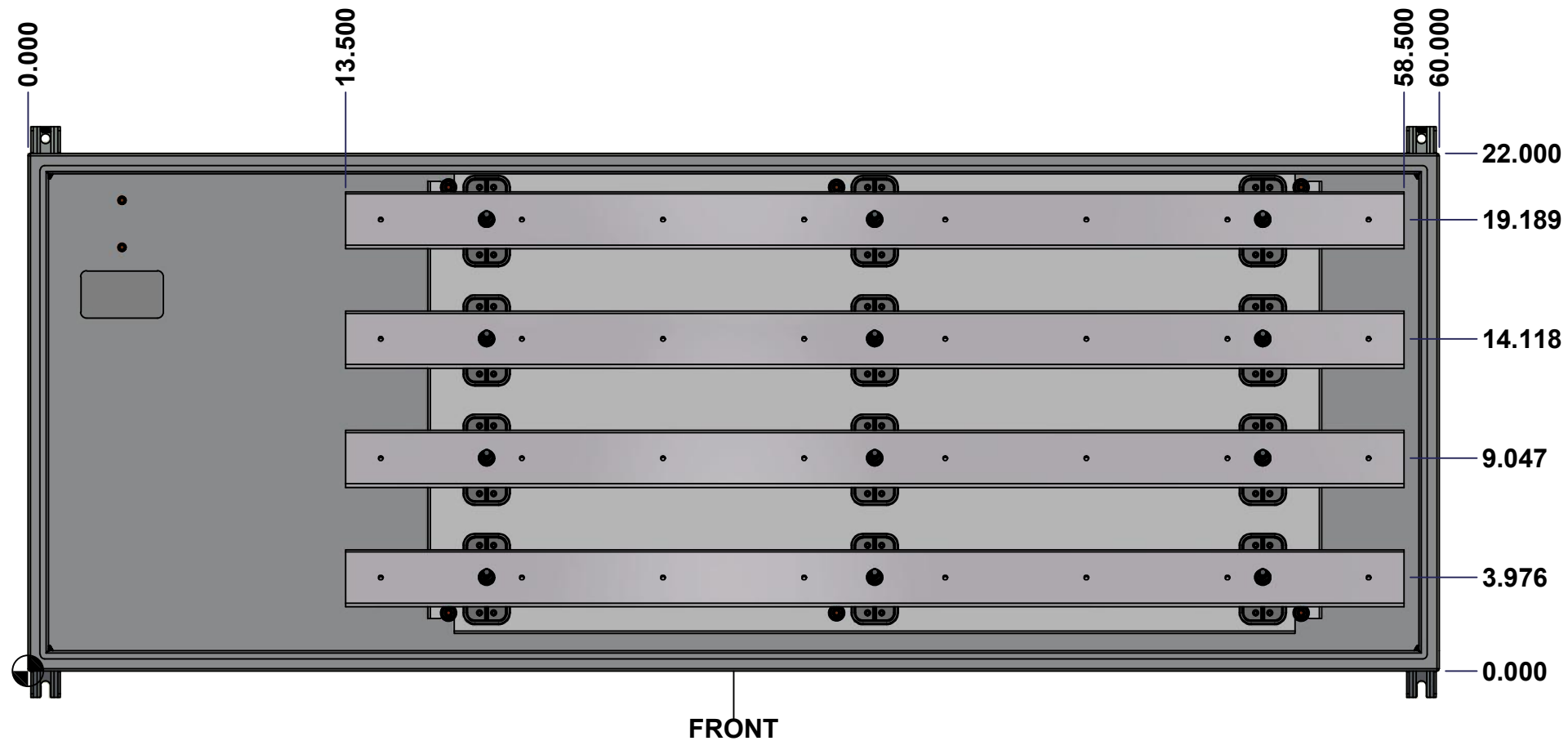

| | | | |
|--|-------------------------------------|----------|---------|
| | Description | Status | |
| | 1412BT 400A - 4Wires x 60" Assembly | (NULL) | |
| | Part Number Numéro Pièce | Rev. | |
| | 1412BT05404DT | 0 | 2 15 |

This drawing is confidential and must not be reproduced or used without the consent of EXM

Ce dessin est confidentiel et ne doit pas être reproduit ou utilisé sans le consentement de EXM



TOP



BACK

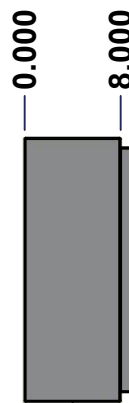

LEFT

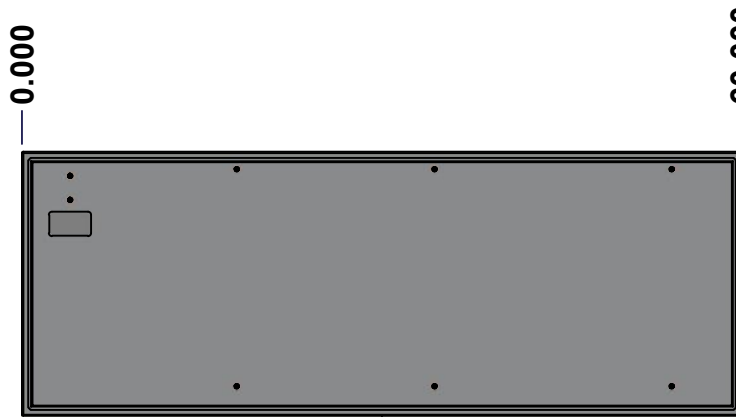

FRONT

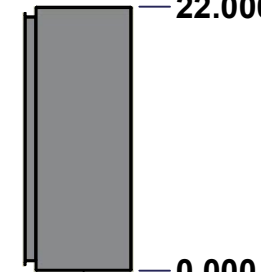



RIGHT

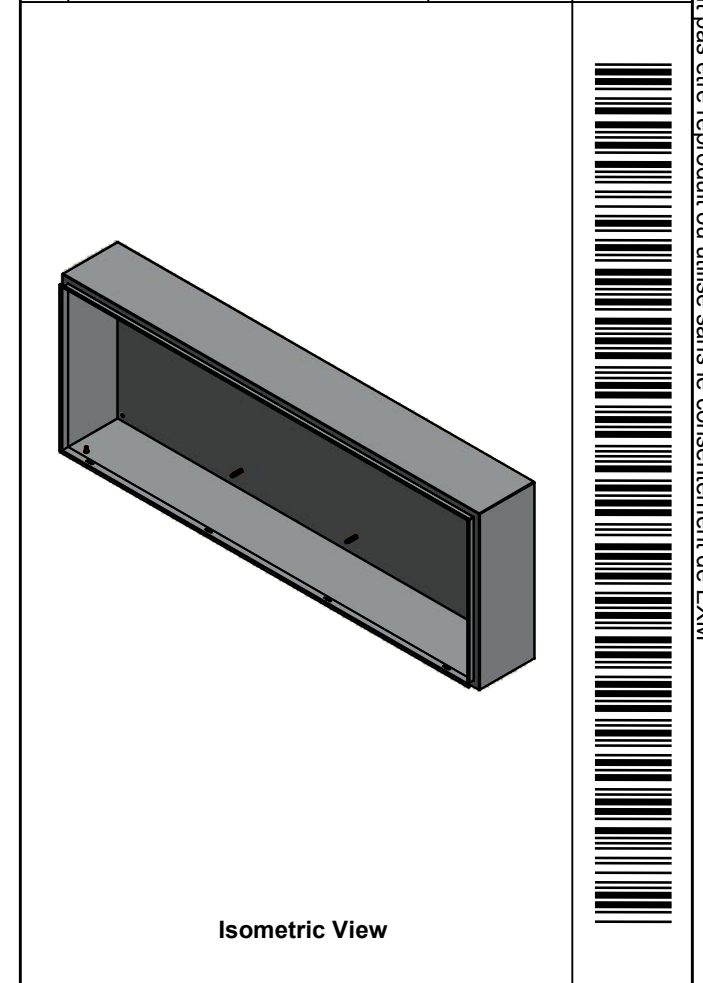

BOTTOM

| No. | Revisions | Date | By/Par |
|-----|-----------|------|--------|
| | | | |
| | | | |
| | | | |
| | | | |
| | | | |

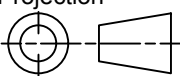

| | | |
|--|---|---|
|  Tél: (450) 979-4373 Fax: (450) 979-4626 www.exmweb.com | | Flatness Aplatissement Max 3.0mm Projection  |
| Customer Client | Date | |
| Drawn By Dessiné Par | BoxCad: BoxCad | Date 30-Sep-22 |
| Material Matière | 14 Ga Cold Rolled A1008 CS Type B (1.7mm) | |
| Color Couleur | Asa-61 Grey | Finish Fini Smooth |
| Description | Detail Rev. | |
| 1412BT 22" x 60" x 8" Body | | |
| Part Number Numéro Pièce | Rev. 0 | 4 / 15 |

SEE BILL OF MATERIAL ON LAST PAGE

1412BT05404DTB

This drawing is confidential and must not be reproduced or used without the consent of Eurobox

Ce dessin est confidentiel et ne doit pas être reproduit ou utilisé sans le consentement de Eurobox

STANDARD FEATURES ARE NOT LISTED IN THIS HOLE TABLE

HOLE TABLE - BACK VIEW (CUSTOM FEATURE ONLY)

| CUT-OUT | XDIM | YDIM | DESCRIPTION |
|---------|--------|--------|-----------------------------|
| 1 | 56.000 | 20.000 | GND STUD M8 x 35mm (Inside) |
| 2 | 56.000 | 18.000 | GND STUD M8 x 35mm (Inside) |
| 3 | 5.875 | 20.563 | IP STUD M8 x 35mm (Inside) |
| 4 | 42.125 | 20.563 | IP STUD M8 x 35mm (Inside) |
| 5 | 5.875 | 2.475 | IP STUD M8 x 35mm (Inside) |
| 6 | 42.125 | 2.475 | IP STUD M8 x 35mm (Inside) |
| 7 | 25.625 | 20.563 | IP STUD M8 x 35mm (Inside) |
| 8 | 25.625 | 2.475 | IP STUD M8 x 35mm (Inside) |

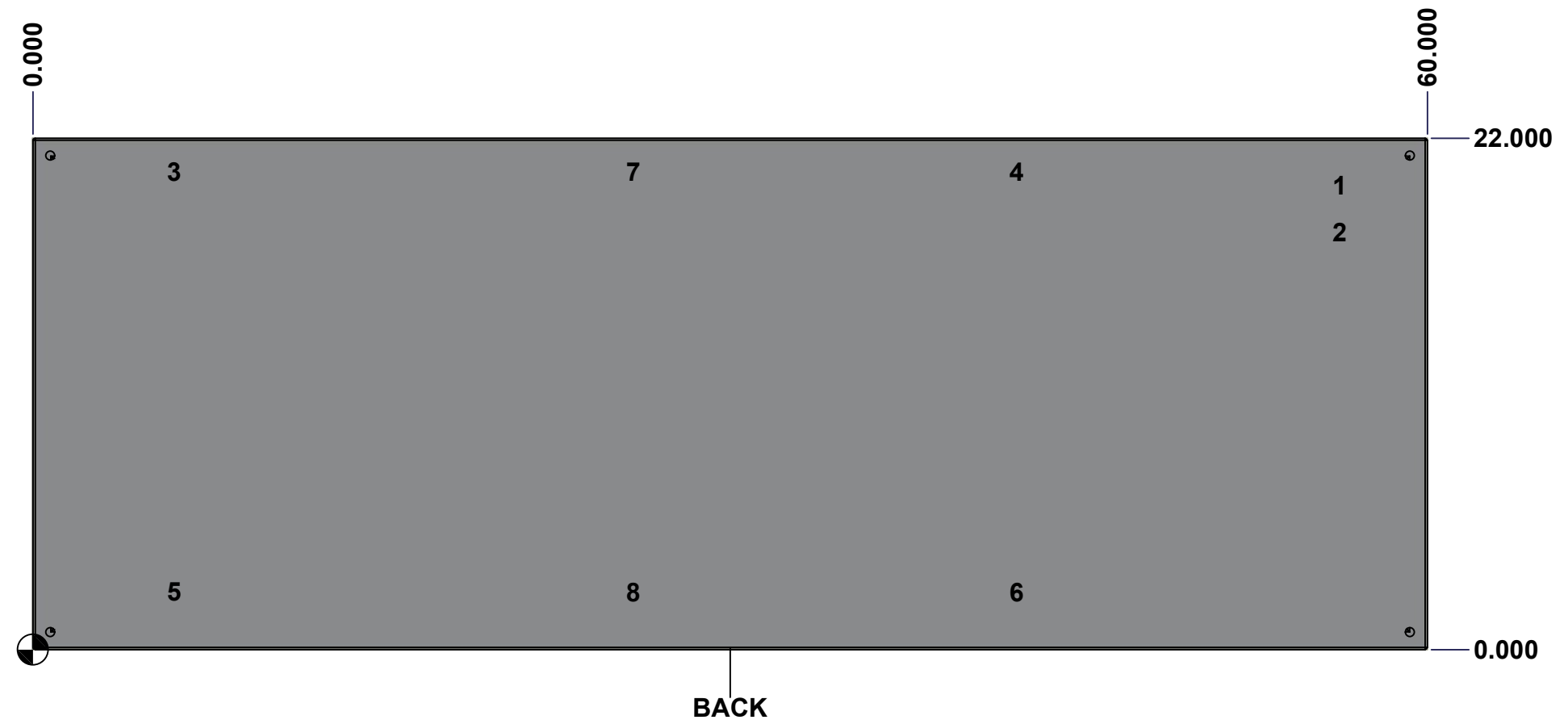



| | | |
|--|-----------------------------|--------------|
| | Description | Status |
| | 1412BT 22" x 60" x 8" Body | (NULL) |
| | Part Number Numéro Pièce | Rev. |
| | 1412BT05404DTB | 0 / 5 |
| | | 15 |

This drawing is confidential and must not be reproduced or used without the consent of EXM

Ce dessin est confidentiel et ne doit pas être reproduit ou utilisé sans le consentement de EXM

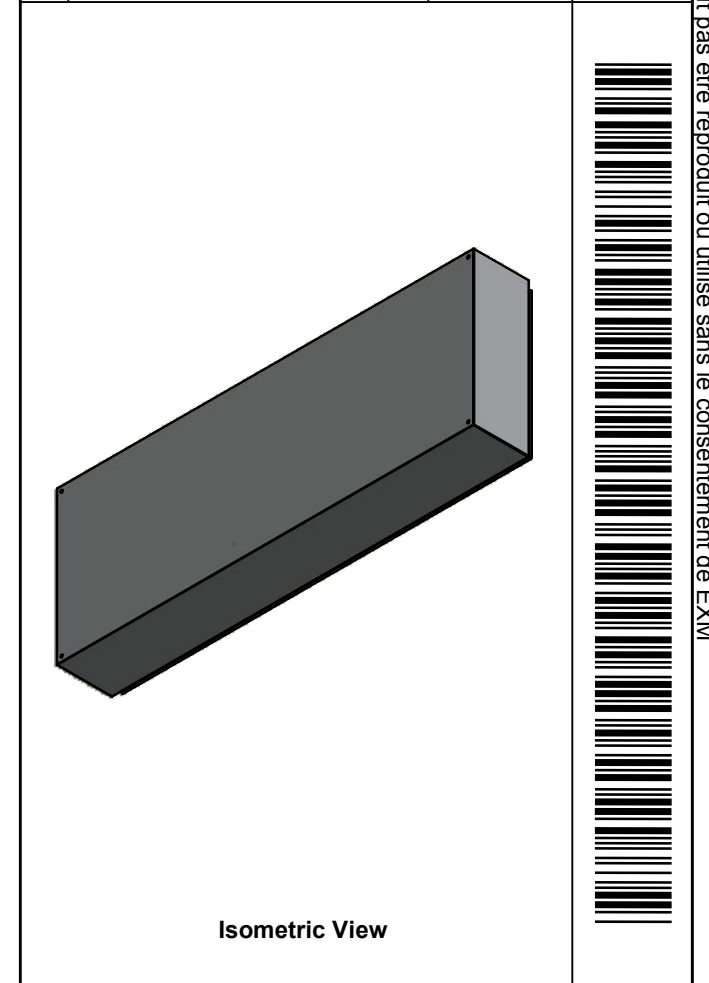
| No. | Revisions | Date | By/Par |
|-----|-----------|------|--------|
| | | | |
| | | | |
| | | | |
| | | | |
| | | | |

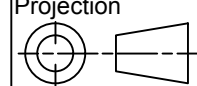

| | | |
|--|---|---|
|  Tél: (450) 979-4373 Fax: (450) 979-4626 www.exmweb.com | | Flatness Aplatissement Max 3.0mm Projection  |
| Customer Client | Date | |
| Drawn By Dessiné Par | BoxCad: BoxCad | Date 30-Sep-22 |
| Material Matière | 14 Ga Cold Rolled A1008 CS Type B (1.7mm) | |
| Color Couleur | Asa-61 Grey | Finish Fini Smooth |
| Description | | Detail Rev. |
| 1412BT 22" x 60" x 8" Body | | |
| Part Number Numéro Pièce | Rev. | 6 |
| 1412BT05404DTB | 0 | 15 |

| Qty | Part Number | Rev | Description |
|------------|------------------|-----|--|
| 1 | STK-P-02400S | 0 | Powder Paint (Asa-61 Grey / Smooth) |
| 8 | STK-Q-16005 | 1 | Stud M8 x 35 (No Paint Cap Required) |
| 1 | STK-Q-16080 | 0 | Ground Stud M6 x 16mm |
| 1 | STK-S-00100 | 0 | 3.5" x 2" Silver Milar Flexcon Sticker |
| 1 | 1412BT05404DTB-P | 0 | 1412BT 22" x 60" x 8" Body Part |
| Parts List | | | |

This drawing is confidential and must not be reproduced or used without the consent of Eurobox

Ce dessin est confidentiel et ne doit pas être reproduit ou utilisé sans le consentement de Eurobox

STANDARD FEATURES ARE NOT LISTED IN THIS HOLE TABLE

HOLE TABLE - FRONT VIEW (CUSTOM FEATURE ONLY)

| CUT-OUT | XDIM | YDIM | DESCRIPTION |
|---------|--------|-------|------------------------------|
| 1 | 43.500 | 1.250 | RND Ø0.201 THREAD 1/4-20 UNC |
| 2 | 37.500 | 1.250 | RND Ø0.201 THREAD 1/4-20 UNC |
| 3 | 31.500 | 1.250 | RND Ø0.201 THREAD 1/4-20 UNC |
| 4 | 25.500 | 1.250 | RND Ø0.201 THREAD 1/4-20 UNC |
| 5 | 19.500 | 1.250 | RND Ø0.201 THREAD 1/4-20 UNC |
| 6 | 13.500 | 1.250 | RND Ø0.201 THREAD 1/4-20 UNC |
| 7 | 7.500 | 1.250 | RND Ø0.201 THREAD 1/4-20 UNC |
| 8 | 1.500 | 1.250 | RND Ø0.201 THREAD 1/4-20 UNC |

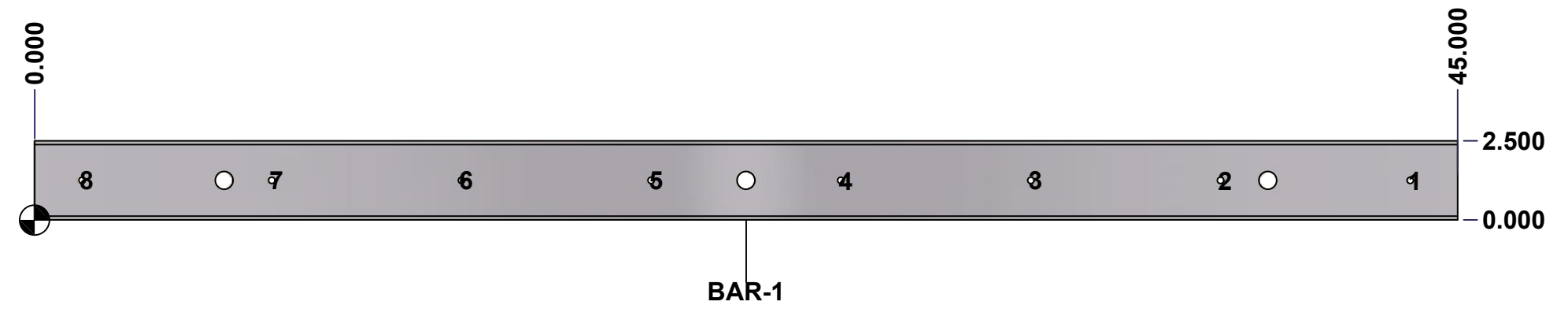

| | | |
|--|---|--------------|
| | Description | Status |
| | Rounded Edge Aluminum Bar 1/4" x 2 1/2" | (NULL) |
| | Part Number Numéro Pièce | Rev. |
| | 1412BT05404DTBAR1-P | 0 / 7 |
| | | 15 |

This drawing is confidential and must not be reproduced or used without the consent of Eurobox

Ce dessin est confidentiel et ne doit pas être reproduit ou utilisé sans le consentement de Eurobox

STANDARD FEATURES ARE NOT LISTED IN THIS HOLE TABLE

HOLE TABLE - FRONT VIEW (CUSTOM FEATURE ONLY)

| CUT-OUT | XDIM | YDIM | DESCRIPTION |
|---------|--------|-------|------------------------------|
| 1 | 43.500 | 1.250 | RND Ø0.201 THREAD 1/4-20 UNC |
| 2 | 37.500 | 1.250 | RND Ø0.201 THREAD 1/4-20 UNC |
| 3 | 31.500 | 1.250 | RND Ø0.201 THREAD 1/4-20 UNC |
| 4 | 25.500 | 1.250 | RND Ø0.201 THREAD 1/4-20 UNC |
| 5 | 19.500 | 1.250 | RND Ø0.201 THREAD 1/4-20 UNC |
| 6 | 13.500 | 1.250 | RND Ø0.201 THREAD 1/4-20 UNC |
| 7 | 7.500 | 1.250 | RND Ø0.201 THREAD 1/4-20 UNC |
| 8 | 1.500 | 1.250 | RND Ø0.201 THREAD 1/4-20 UNC |

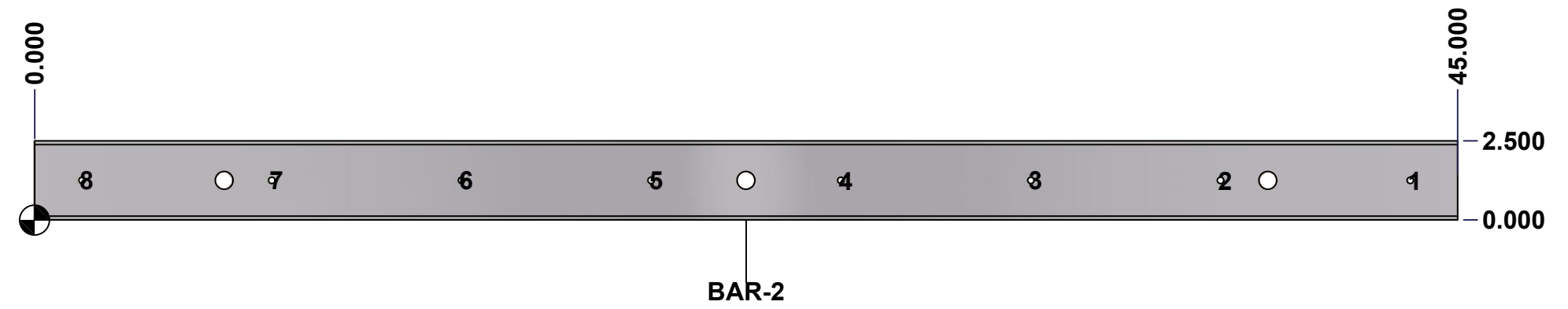

| | | |
|--|---|----------|
| | Description | Status |
| | Rounded Edge Aluminum Bar 1/4" x 2 1/2" | (NULL) |
| | Part Number | Rev. |
| | Numéro Pièce | 8 |
| | 1412BT05404DTBAR2-P | 0 |
| | | 15 |

This drawing is confidential and must not be reproduced or used without the consent of Eurobox

Ce dessin est confidentiel et ne doit pas être reproduit ou utilisé sans le consentement de Eurobox

STANDARD FEATURES ARE NOT LISTED IN THIS HOLE TABLE

HOLE TABLE - FRONT VIEW (CUSTOM FEATURE ONLY)

| CUT-OUT | XDIM | YDIM | DESCRIPTION |
|---------|--------|-------|------------------------------|
| 1 | 43.500 | 1.250 | RND Ø0.201 THREAD 1/4-20 UNC |
| 2 | 37.500 | 1.250 | RND Ø0.201 THREAD 1/4-20 UNC |
| 3 | 31.500 | 1.250 | RND Ø0.201 THREAD 1/4-20 UNC |
| 4 | 25.500 | 1.250 | RND Ø0.201 THREAD 1/4-20 UNC |
| 5 | 19.500 | 1.250 | RND Ø0.201 THREAD 1/4-20 UNC |
| 6 | 13.500 | 1.250 | RND Ø0.201 THREAD 1/4-20 UNC |
| 7 | 7.500 | 1.250 | RND Ø0.201 THREAD 1/4-20 UNC |
| 8 | 1.500 | 1.250 | RND Ø0.201 THREAD 1/4-20 UNC |

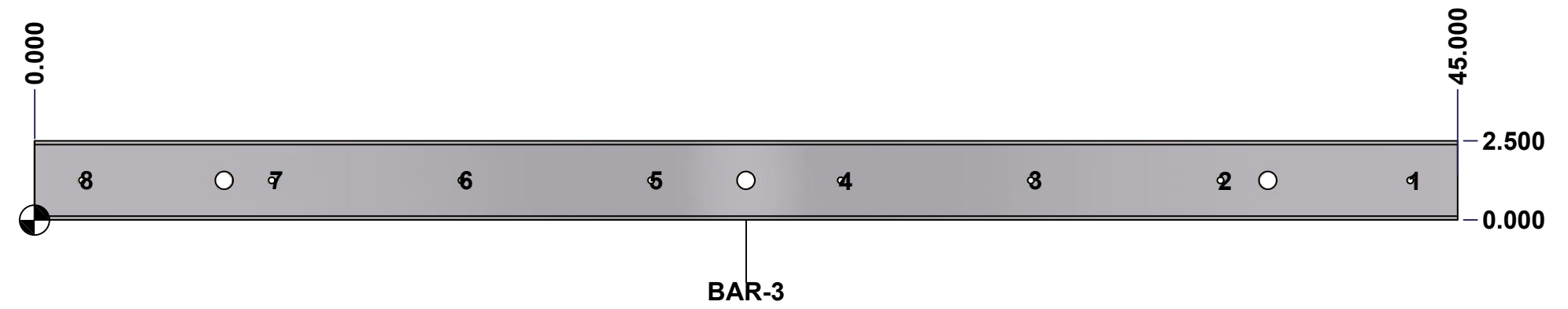

| | | |
|--|---|--------------|
| | Description | Status |
| | Rounded Edge Aluminum Bar 1/4" x 2 1/2" | (NULL) |
| | Part Number Numéro Pièce | Rev. |
| | 1412BT05404DTBAR3-P | 0 / 9 |
| | | 15 |

This drawing is confidential and must not be reproduced or used without the consent of Eurobox

Ce dessin est confidentiel et ne doit pas être reproduit ou utilisé sans le consentement de Eurobox

STANDARD FEATURES ARE NOT LISTED IN THIS HOLE TABLE

HOLE TABLE - FRONT VIEW (CUSTOM FEATURE ONLY)

| CUT-OUT | XDIM | YDIM | DESCRIPTION |
|---------|--------|-------|------------------------------|
| 1 | 1.500 | 1.250 | RND Ø0.201 THREAD 1/4-20 UNC |
| 2 | 43.500 | 1.250 | RND Ø0.201 THREAD 1/4-20 UNC |
| 3 | 37.500 | 1.250 | RND Ø0.201 THREAD 1/4-20 UNC |
| 4 | 31.500 | 1.250 | RND Ø0.201 THREAD 1/4-20 UNC |
| 5 | 25.500 | 1.250 | RND Ø0.201 THREAD 1/4-20 UNC |
| 6 | 19.500 | 1.250 | RND Ø0.201 THREAD 1/4-20 UNC |
| 7 | 13.500 | 1.250 | RND Ø0.201 THREAD 1/4-20 UNC |
| 8 | 7.500 | 1.250 | RND Ø0.201 THREAD 1/4-20 UNC |

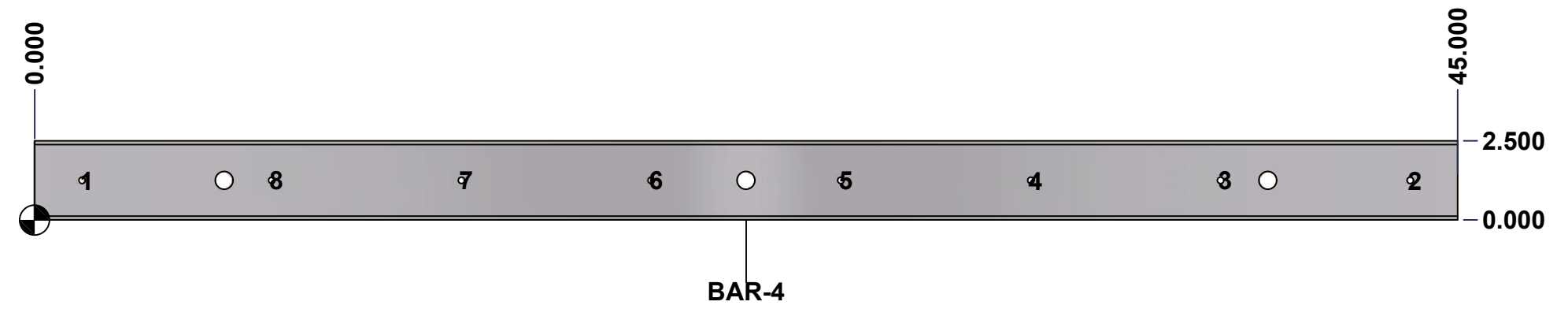

| | | | |
|--|--|----------|----|
| | Description | Status | |
| | Rounded Edge Aluminum Bar 1/4" x 2 1/2" | (NULL) | |
| | Part Number | Rev. | 10 |
| | Numéro Pièce 1412BT05404DTBAR4-P | 0 | 15 |

This drawing is confidential and must not be reproduced or used without the consent of EXM

Ce dessin est confidentiel et ne doit pas être reproduit ou utilisé sans le consentement de EXM



TOP

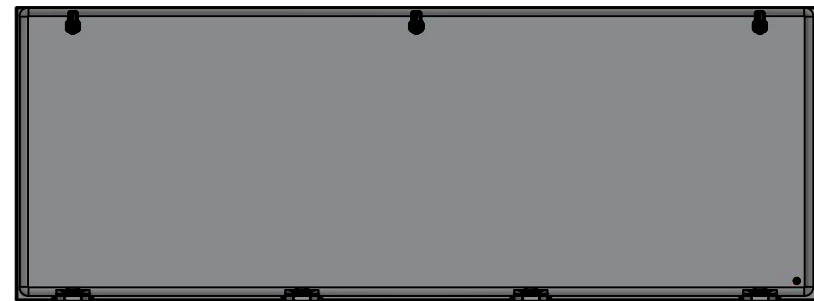

BACK

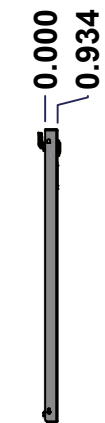

LEFT

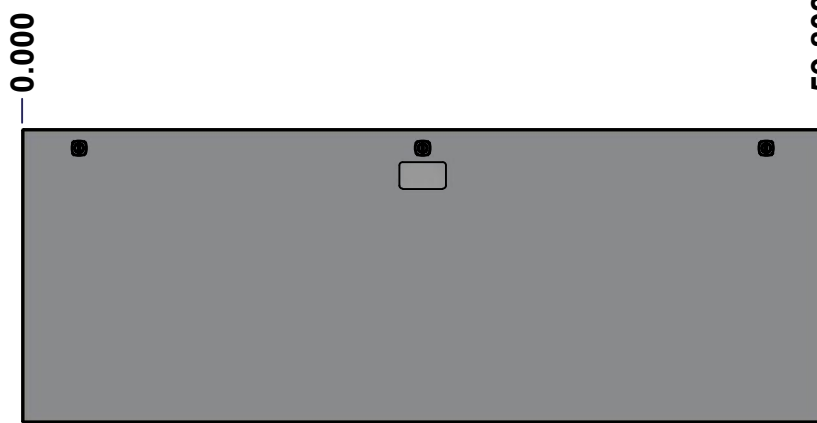

FRONT

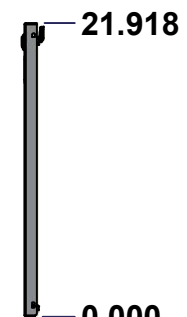

RIGHT



BOTTOM

| No. | Revisions | Date | By/Par |
|-----|-----------|------|--------|
| | | | |
| | | | |
| | | | |
| | | | |

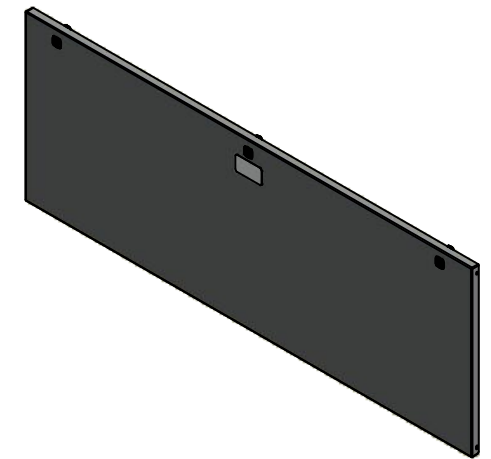

Isometric View



Tél: (450) 979-4373
 Fax: (450) 979-4626
www.exmweb.com

Flatness
Aplatissement

Max 3.0mm

Projection

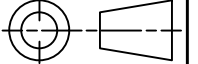

| | |
|--|-----------------|
| Customer Client | Date |
| Drawn By / Dessiné Par: BoxCad: BoxCad | Date: 30-Sep-22 |

Material / Matière: 14 Ga Cold Rolled A1008 CS Type B (1.7mm)

| | |
|------------------------------|-----------------------|
| Color / Couleur: Asa-61 Grey | Finish / Fini: Smooth |
|------------------------------|-----------------------|

| | |
|-------------------------------------|-------------|
| Description: 1412BT 22" x 60" Cover | Detail Rev. |
|-------------------------------------|-------------|

| | | |
|--|--------|---------|
| Part Number / Numéro Pièce: 1412BT05404DTC | Rev. 0 | 11 / 15 |
|--|--------|---------|

SEE BILL OF MATERIAL ON LAST PAGE

This drawing is confidential and must not be reproduced or used without the consent of Eurobox

Ce dessin est confidentiel et ne doit pas être reproduit ou utilisé sans le consentement de Eurobox

STANDARD FEATURES ARE NOT LISTED IN THIS HOLE TABLE

HOLE TABLE - FRONT VIEW (CUSTOM FEATURE ONLY)

| CUT-OUT | XDIM | YDIM | DESCRIPTION |
|---------|--------|--------|-----------------------------|
| 1 | 1.500 | 1.486 | GND STUD M6 x 16mm (Inside) |
| 2 | 55.553 | 20.494 | LOCK 880 SCQ4-SL @ 90.0° |
| 3 | 29.902 | 20.494 | LOCK 880 SCQ4-SL @ 90.0° |
| 4 | 4.250 | 20.494 | LOCK 880 SCQ4-SL @ 90.0° |

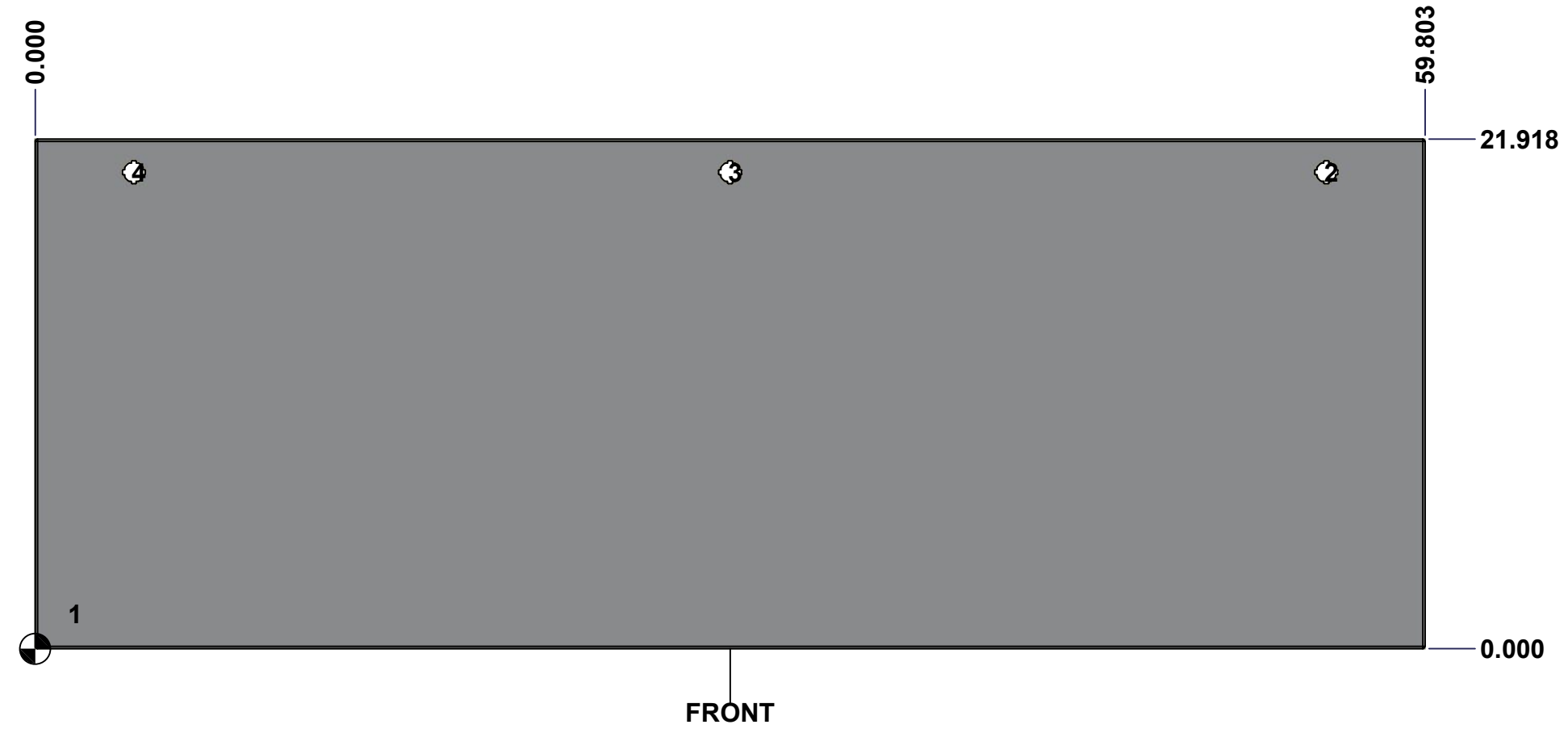

| | | | |
|--|-----------------------------|----------|----------|
| | Description | Status | |
| | 1412BT 22" x 60" Cover | (NULL) | |
| | Part Number Numéro Pièce | Rev. | |
| | 1412BT05404DTC | 0 | 12 15 |

This drawing is confidential and must not be reproduced or used without the consent of EXM

Ce dessin est confidentiel et ne doit pas être reproduit ou utilisé sans le consentement de EXM

| No. | Revisions | Date | By/Par |
|-----|-----------|------|--------|
| | | | |
| | | | |
| | | | |
| | | | |
| | | | |

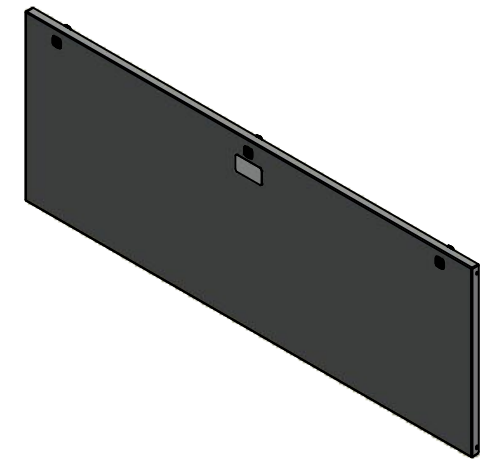

Isometric View

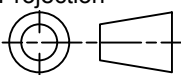

| | | |
|--|---|---|
|  Tél: (450) 979-4373 Fax: (450) 979-4626 www.exmweb.com | Flatness Aplatissement | Max 3.0mm |
| | Projection |  |
| Customer Client | Date | |
| Drawn By Dessiné Par | BoxCad: BoxCad | Date 30-Sep-22 |
| Material Matière | 14 Ga Cold Rolled A1008 CS Type B (1.7mm) | |
| Color Couleur | Asa-61 Grey | Finish Fini Smooth |
| Description | 1412BT 22" x 60" Cover | Detail Rev. |
| Part Number Numéro Pièce | 1412BT05404DTC | Rev. 0 |

| Qty | Part Name | Rev | Description |
|------------|------------------|-----|---|
| 1 | 1412BT05404DTG | 0 | 1412BT 22" x 60" Cover Gasket |
| 1 | STK-P-02400S | 0 | Powder Paint (Asa-61 Grey / Smooth) |
| 4 | STK-K-09800 | 10 | 5412 ES Hinge with 2 Captive Hinge Pins |
| 1 | STK-Q-16080 | 0 | Ground Stud M6 x 16mm |
| 1 | STK-S-00100 | 0 | 3.5" x 2" Silver Milar Flexcon Sticker |
| 1 | 1412BT05404DTC-P | 0 | 1412BT 22" x 60" Cover Part |
| 3 | 880 SCQ4-SL | 6 | 5412 ES 1/4 Turn Lock |
| Parts List | | | |

This drawing is confidential and must not be reproduced or used without the consent of EXM

Ce dessin est confidentiel et ne doit pas être reproduit ou utilisé sans le consentement de EXM

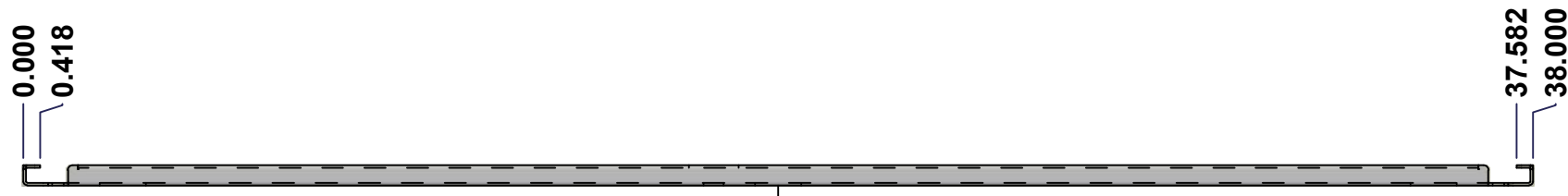

TOP

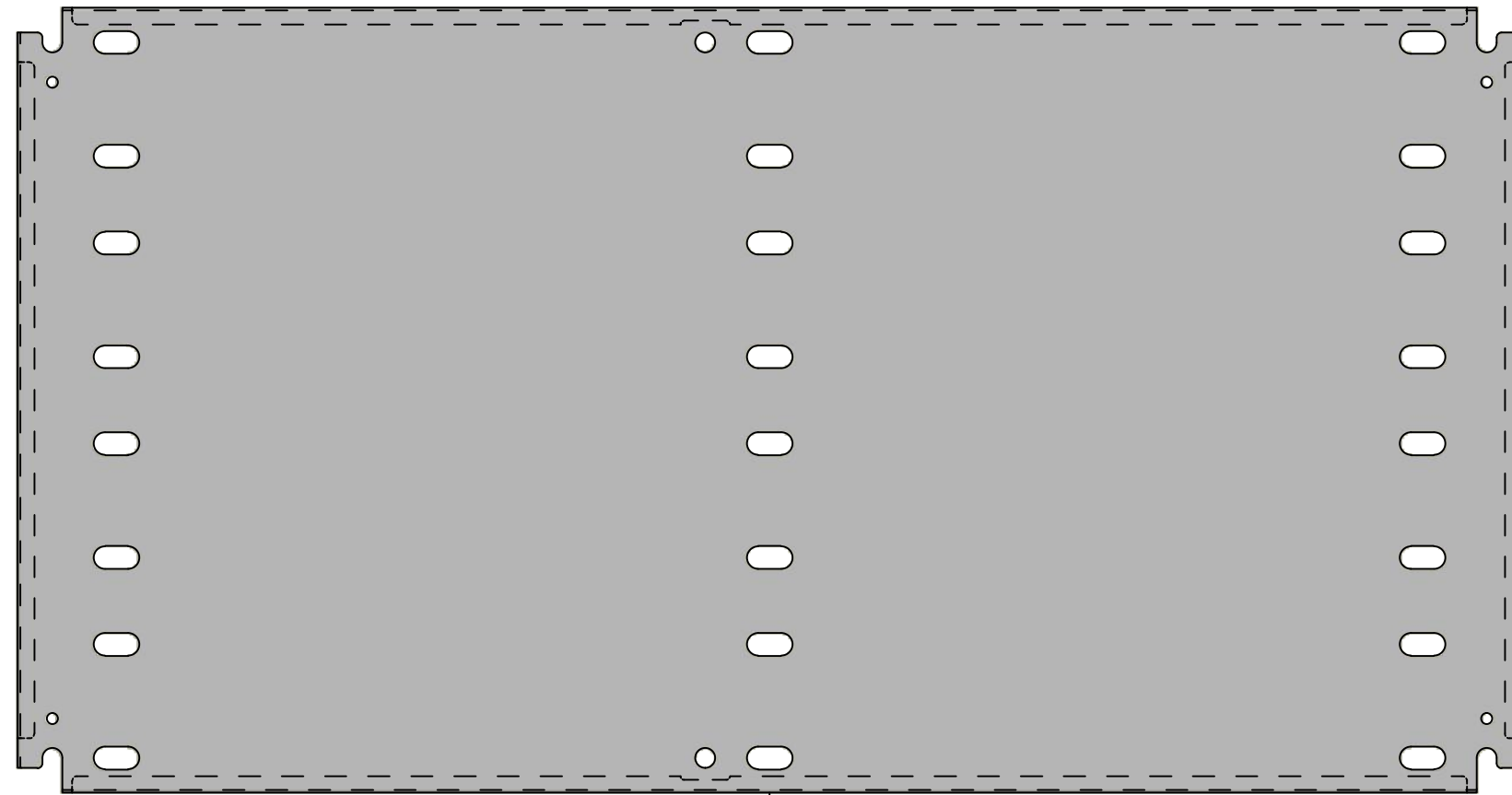

FRONT

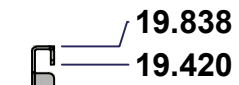

RIGHT

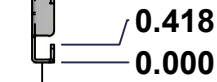

| No. | Revisions | Date | By/Par |
|-----|-----------|------|--------|
| | | | |
| | | | |
| | | | |
| | | | |
| | | | |

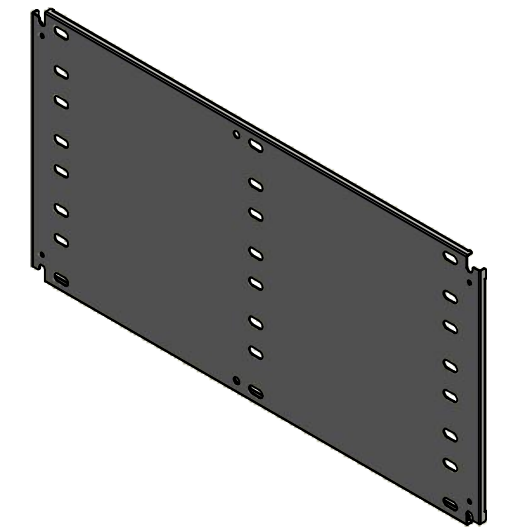

Isometric View



Tél: (450) 979-4373
Fax: (450) 979-4626
www.exmweb.com

Flatness
Aplatissement
Max 3.0mm
Projection

| | |
|---|-----------------|
| Customer Client | Date |
| Drawn By / Dessiné Par: BoxCad: BoxCad | Date: 30-Sep-22 |
| Material / Matière: 14 Ga Cold Rolled A1008 CS Type B (1.7mm) | |

| | |
|--------------------------------|-----------------------|
| Color / Couleur: White RAL9003 | Finish / Fini: Smooth |
|--------------------------------|-----------------------|

| | |
|---|-------------|
| Description: 1412BT 19.838" x 38" Inner Panel | Detail Rev. |
|---|-------------|

| | | | |
|--|--------|----|----|
| Part Number / Numéro Pièce: 1412BT05404DTIP1 | Rev. 0 | 14 | 15 |
|--|--------|----|----|

SEE BILL OF MATERIAL ON LAST PAGE

This drawing is confidential and must not be reproduced or used without the consent of EXM

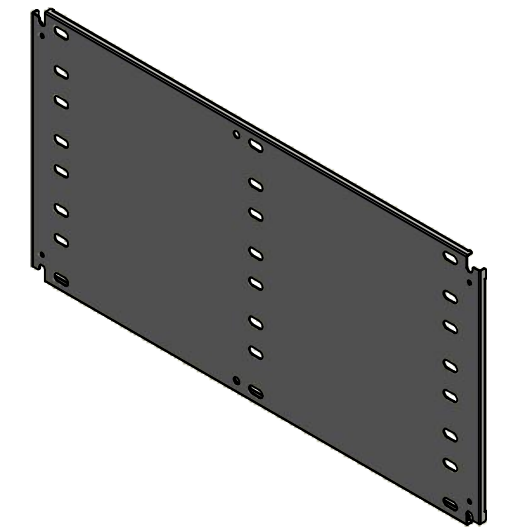

Ce dessin est confidentiel et ne doit pas être reproduit ou utilisé sans le consentement de EXM

| No. | Revisions | Date | By/Par |
|-----|-----------|------|--------|
| | | | |
| | | | |
| | | | |
| | | | |
| | | | |



Isometric View

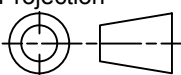

| | | |
|--|---|---|
|  Tél: (450) 979-4373 Fax: (450) 979-4626 www.exmweb.com | | Flatness Aplatissement  Max 3.0mm |
| Projection  | | Date |
| Customer Client | BoxCad: BoxCad | Date 30-Sep-22 |
| Material Matière | 14 Ga Cold Rolled A1008 CS Type B (1.7mm) | |
| Color Couleur | White RAL9003 | Finish Fini Smooth |
| Description | | Detail Rev. |
| 1412BT 19.838" x 38" Inner Panel | | |
| Part Number Numéro Pièce | | Rev. 15 |
| 1412BT05404DTIP1 | | 0 / 15 |

| Qty | Part Number | Rev | Description |
|------------|--------------------|-----|---------------------------------------|
| 1 | STK-P-02401S | 0 | Powder Paint (White / Smooth) |
| 1 | 1412BT05404DTIP1-P | 0 | 1412BT 19.838" x 60" Inner Panel Part |
| Parts List | | | |