

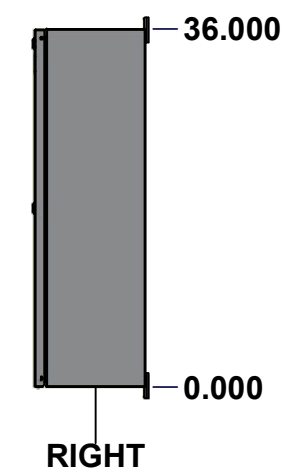

This drawing is confidential and must not be reproduced or used without the consent of EXM

Ce dessin est confidentiel et ne doit pas être reproduit ou utilisé sans le consentement de EXM

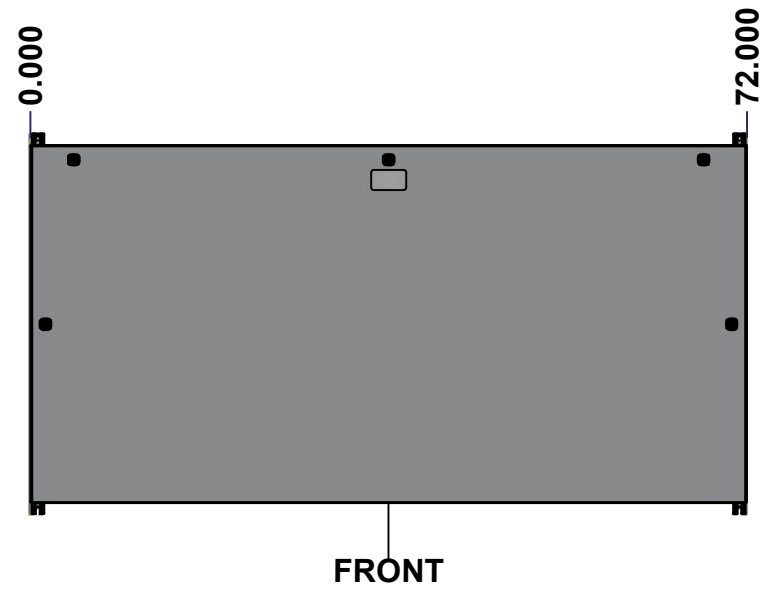
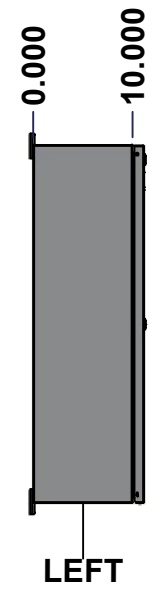
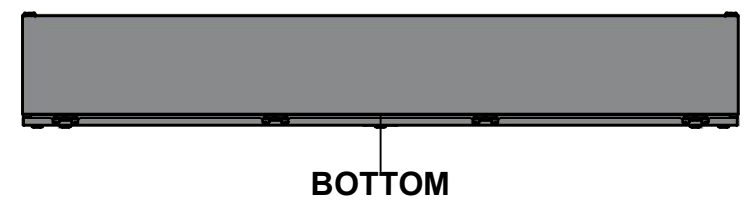
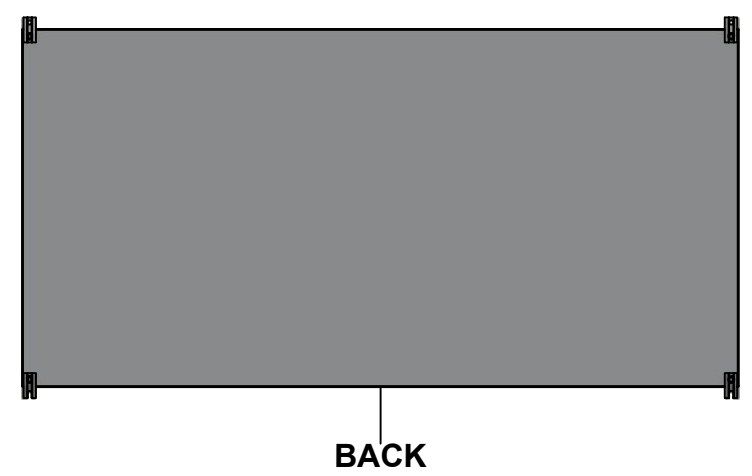
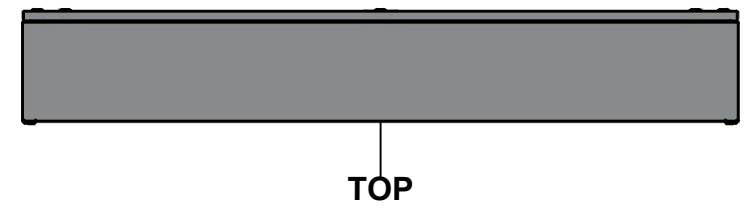
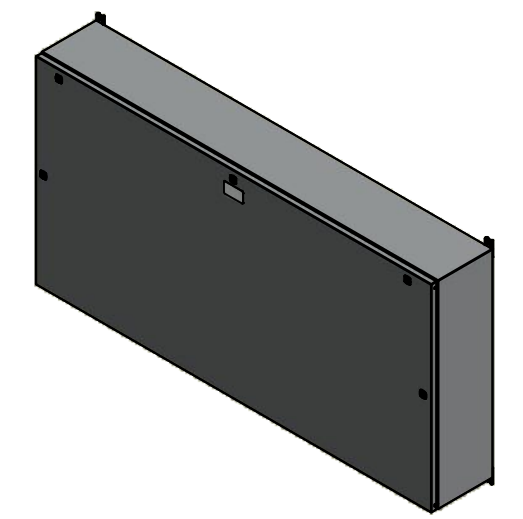

No.	Revisions	Date	By/Par

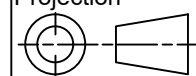

 Tél: (450) 979-4373 Fax: (450) 979-4626 <a href="http://www.exmweb.com">www.exmweb.com</a>	Flatness Aplatissement	Max 3.0mm
	Projection	
Customer Client	Date	
Drawn By Dessiné Par	BoxCad: BoxCad	Date 2022-10-03
Material Matière	14 Ga Cold Rolled A1008 CS Type B (1.7mm)	
Color Couleur	Asa-61 Grey	Finish Fini Smooth
Description	Detail Rev.	
1412BT 1000A - 5Wires x 72" Assembly		
Part Number Numéro Pièce	Rev.	1
<b>1412BT061005DT</b>	<b>0</b>	16

**SEE BILL OF MATERIAL ON LAST PAGE**

This drawing is confidential and must not be reproduced or used without the consent of Eurobox

**STANDARD FEATURES ARE NOT LISTED IN THIS HOLE TABLE**

Ce dessin est confidentiel et ne doit pas être reproduit ou utilisé sans le consentement de Eurobox

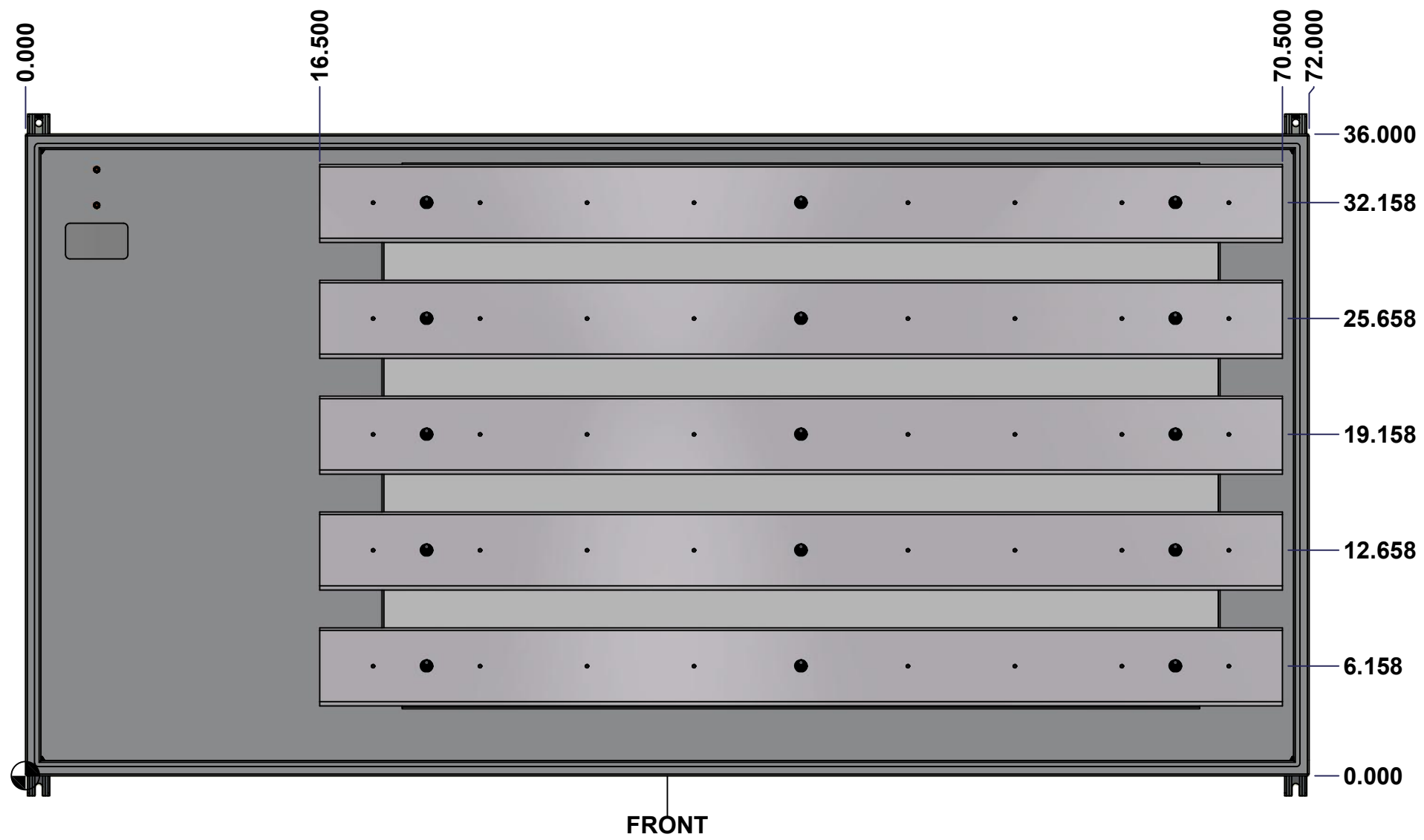

	Description 1412BT 1000A - 5Wires x 72" Assembly	Status (NULL)
	Part Number Numéro Pièce <b>1412BT061005DT</b>	Rev. 2 <b>0</b>

This drawing is confidential and must not be reproduced or used without the consent of EXM

Ce dessin est confidentiel et ne doit pas être reproduit ou utilisé sans le consentement de EXM

NOTE	
ITEM	DESCRIPTION
1	NEMA 4/12 Enclosure
2	C/W Standard ground studs on box and cover
3	W/O Standard door stiffener
4	C/W Special inner panel (Sold separately)
5	C/W Standard inner panel mounting studs

No.	Revisions	Date	By/Par

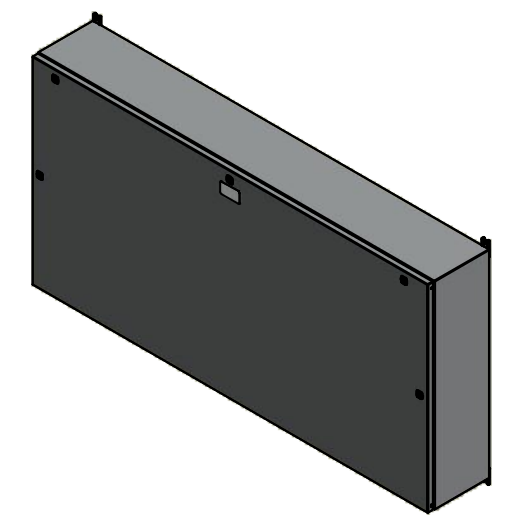

Isometric View



PACKING		
ITEM	QTY	DESCRIPTION
Cardboard sleeve	2	Top and Bottom
Cardboard strip	2	Between back of enclosure and inner panel
Plastic bag	1	To protect cover surface and inside gasket
Cardboard corner	4	To reinforced for the plastic strap tightening
Plastic strap - Black	2	To Squeeze 2 cardboard sleeve together
Packaging label	3	White label with PN
Plastic strap- Green	2	To secure the enclosure to the wood pallet
Wood Pallet	1	2" deeper and 3" larger than enclosure size

1	885 ESMF1	0	885 ESMF1 Mounting Feet Kit
1	1412BT061005DTBAR4-P	0	Rounded Edge Aluminum Bar 3/8" x 4 1/2"
1	1412BT061005DTBAR1-P	0	Rounded Edge Aluminum Bar 3/8" x 4 1/2"
1	1412BT061005DTBAR2-P	0	Rounded Edge Aluminum Bar 3/8" x 4 1/2"
1	1412BT061005DTBAR3-P	0	Rounded Edge Aluminum Bar 3/8" x 4 1/2"
1	1412BT061005DTBAR5-P	0	Rounded Edge Aluminum Bar 3/8" x 4 1/2"
1	1412BT061005DTIP1	0	1412BT 30.625" x 47" Inner Panel
15	STK-A-67400	0	Buss Bar Insulator Kit
1	STK-K-01800	5	5412 ES Accessory Kit
4	STK-Q-04050-07	7	M6 x 7mm Hexagon Socket Head Machine Screw with Nyseal
21	STK-Q-07310	2	Flange Lock Nut M8
6	STK-Q-07610	8	M8 Plastic Spacer 22.2mm
1	1412BT061005DTB	0	1412BT 36" x 72" x 10" Body
1	1412BT061005DTC	0	1412BT 36" x 72" Cover
Qty	Part Number	Rev	Description
Parts List			

Tél: (450) 979-4373  
Fax: (450) 979-4626  
[www.exmweb.com](http://www.exmweb.com)

Flatness  
Aplatissement  
Max 3.0mm

Projection

Customer Client	Date
Drawn By Dessiné Par BoxCad: BoxCad	Date 2022-10-03
Material Matière 14 Ga Cold Rolled A1008 CS Type B (1.7mm)	
Color Couleur Asa-61 Grey	Finish Fini Smooth
Description 1412BT 1000A - 5Wires x 72" Assembly	Detail Rev.
Part Number Numéro Pièce <b>1412BT061005DT</b>	Rev. 0

This drawing is confidential and must not be reproduced or used without the consent of EXM

Ce dessin est confidentiel et ne doit pas être reproduit ou utilisé sans le consentement de EXM



TOP



BACK



BOTTOM

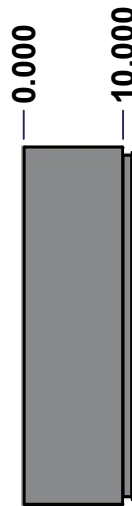

LEFT

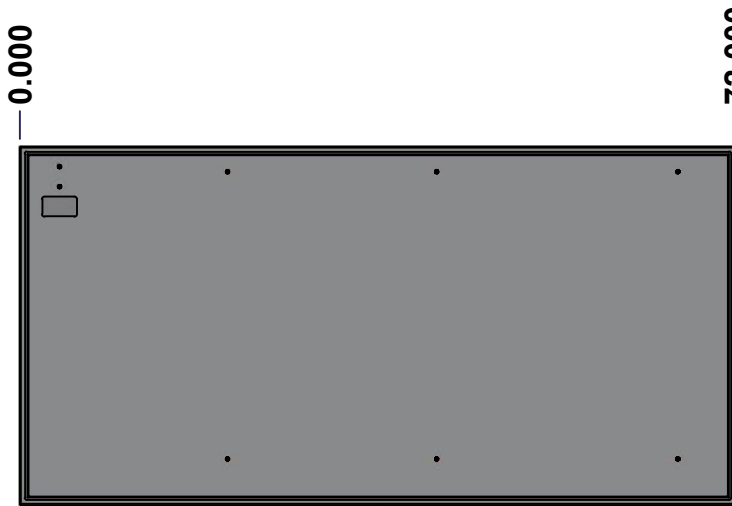

FRONT

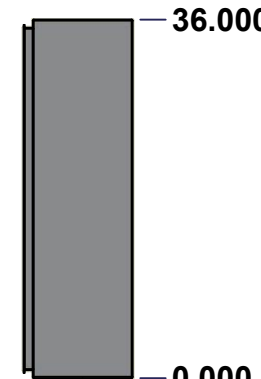

RIGHT

No.	Revisions	Date	By/Par

Isometric View

Tél: (450) 979-4373 Fax: (450) 979-4626 <a href="http://www.exmweb.com">www.exmweb.com</a>		Flatness Aplatissement	
		Max 3.0mm	
Projection		Date	
Customer Client	BoxCad: BoxCad	Date	2022-10-03
Material Matière	14 Ga Cold Rolled A1008 CS Type B (1.7mm)		
Color Couleur	Asa-61 Grey	Finish Fini	Smooth
Description		Detail Rev.	
1412BT 36" x 72" x 10" Body			
Part Number Numéro Pièce	1412BT061005DTB	Rev.	4
SEE BILL OF MATERIAL ON LAST PAGE		0	16

This drawing is confidential and must not be reproduced or used without the consent of Eurobox

Ce dessin est confidentiel et ne doit pas être reproduit ou utilisé sans le consentement de Eurobox

**STANDARD FEATURES ARE NOT LISTED IN THIS HOLE TABLE**

**HOLE TABLE - BACK VIEW (CUSTOM FEATURE ONLY)**

CUT-OUT	XDIM	YDIM	DESCRIPTION
1	68.000	34.000	GND STUD M8 x 35mm (Inside)
2	68.000	32.000	GND STUD M8 x 35mm (Inside)
3	5.875	33.500	IP STUD M8 x 35mm (Inside)
4	51.125	33.500	IP STUD M8 x 35mm (Inside)
5	5.875	4.625	IP STUD M8 x 35mm (Inside)
6	51.125	4.625	IP STUD M8 x 35mm (Inside)
7	30.125	33.500	IP STUD M8 x 35mm (Inside)
8	30.125	4.625	IP STUD M8 x 35mm (Inside)

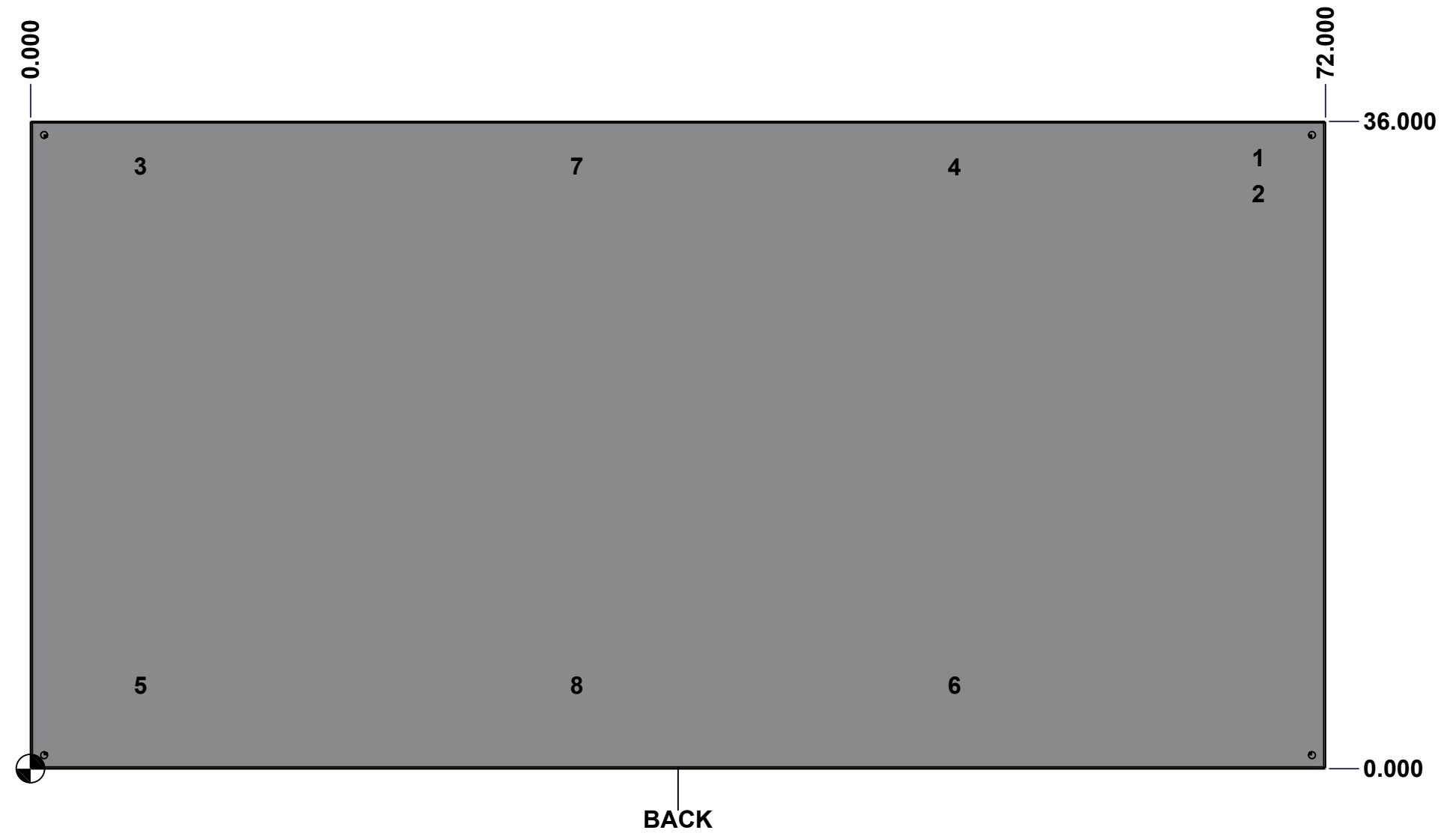



	Description	Status	
	1412BT 36" x 72" x 10" Body	(NULL)	
	Part Number Numéro Pièce	Rev.	5
	<b>1412BT061005DTB</b>	<b>0</b>	16

This drawing is confidential and must not be reproduced or used without the consent of EXM

Ce dessin est confidentiel et ne doit pas être reproduit ou utilisé sans le consentement de EXM

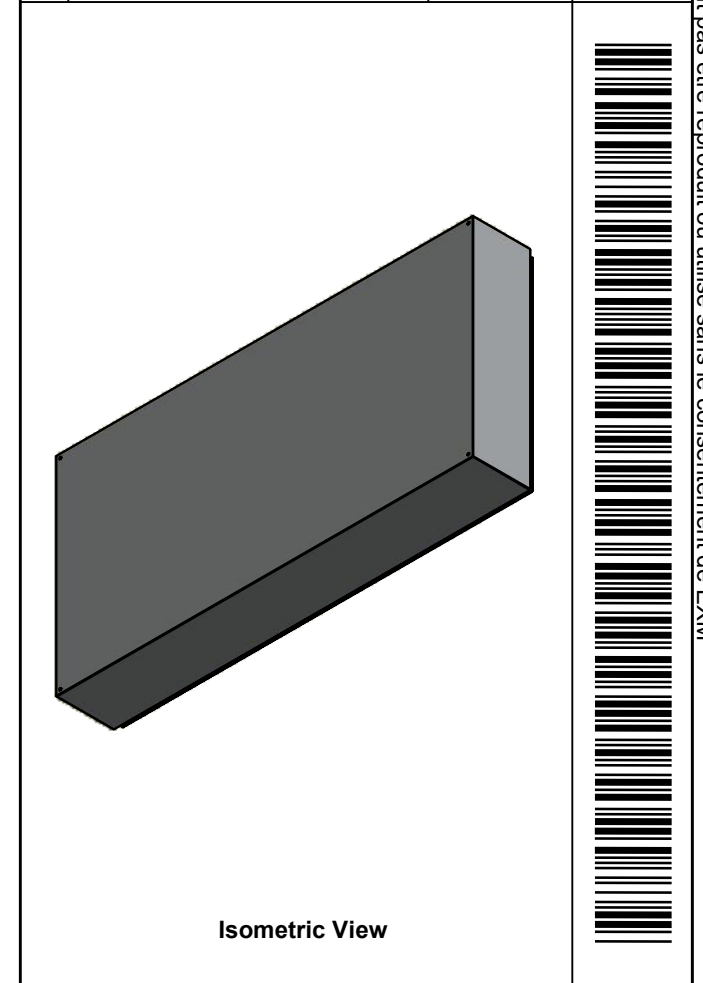
No.	Revisions	Date	By/Par



 Tél: (450) 979-4373 Fax: (450) 979-4626 <a href="http://www.exmweb.com">www.exmweb.com</a>		Flatness Aplatissement	
		Max 3.0mm	
Customer Client		Date	
Drawn By Dessiné Par BoxCad: BoxCad		Date 2022-10-03	
Material Matière 14 Ga Cold Rolled A1008 CS Type B (1.7mm)			
Color Couleur Asa-61 Grey		Finish Fini Smooth	
Description 1412BT 36" x 72" x 10" Body			Detail Rev.
Part Number Numéro Pièce <b>1412BT061005DTB</b>		Rev. <b>0</b>	6 16

Qty	Part Number	Rev	Description
1	STK-P-02400S	0	Powder Paint (Asa-61 Grey / Smooth)
8	STK-Q-16005	1	Stud M8 x 35 (No Paint Cap Required)
1	STK-Q-16080	0	Ground Stud M6 x 16mm
1	STK-S-00100	0	3.5" x 2" Silver Milar Flexcon Sticker
1	1412BT061005DTB-P	0	1412BT 36" x 72" x 10" Body Part
Parts List			

This drawing is confidential and must not be reproduced or used without the consent of Eurobex

Ce dessin est confidentiel et ne doit pas être reproduit ou utilisé sans le consentement de Eurobex

**STANDARD FEATURES ARE NOT LISTED IN THIS HOLE TABLE**

**HOLE TABLE - FRONT VIEW (CUSTOM FEATURE ONLY)**

CUT-OUT	XDIM	YDIM	DESCRIPTION
1	33.000	2.250	RND Ø0.201 THREAD 1/4-20 UNC
2	21.000	2.250	RND Ø0.201 THREAD 1/4-20 UNC
3	15.000	2.250	RND Ø0.201 THREAD 1/4-20 UNC
4	9.000	2.250	RND Ø0.201 THREAD 1/4-20 UNC
5	3.000	2.250	RND Ø0.201 THREAD 1/4-20 UNC
6	51.000	2.250	RND Ø0.201 THREAD 1/4-20 UNC
7	45.000	2.250	RND Ø0.201 THREAD 1/4-20 UNC
8	39.000	2.250	RND Ø0.201 THREAD 1/4-20 UNC

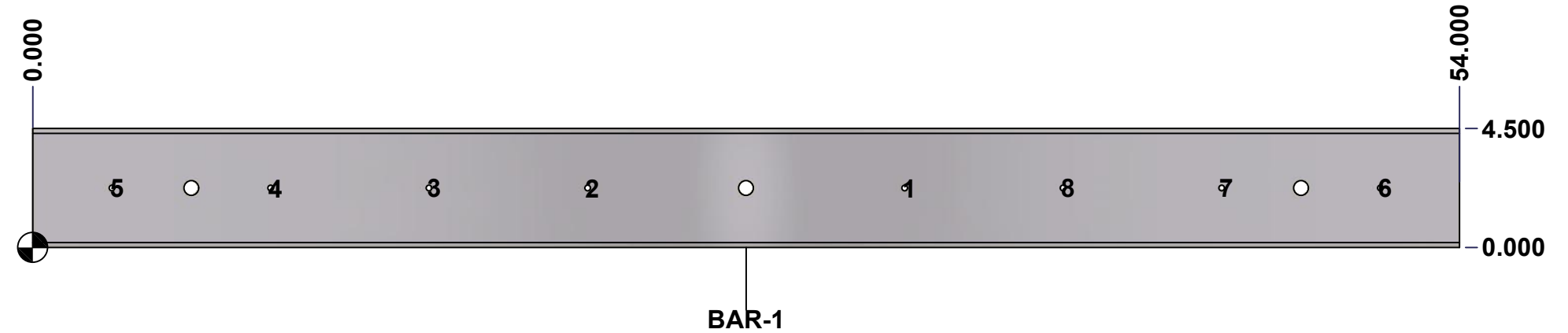

	Description	Status
	Rounded Edge Aluminum Bar 3/8" x 4 1/2"	(NULL)
	Part Number Numéro Pièce	Rev.
	<b>1412BT061005DTBAR1-P</b>	<b>0</b> / 7
		16

This drawing is confidential and must not be reproduced or used without the consent of Eurobex

Ce dessin est confidentiel et ne doit pas être reproduit ou utilisé sans le consentement de Eurobex

**STANDARD FEATURES ARE NOT LISTED IN THIS HOLE TABLE**

**HOLE TABLE - FRONT VIEW (CUSTOM FEATURE ONLY)**

CUT-OUT	XDIM	YDIM	DESCRIPTION
1	51.000	2.250	RND Ø0.201 THREAD 1/4-20 UNC
2	45.000	2.250	RND Ø0.201 THREAD 1/4-20 UNC
3	39.000	2.250	RND Ø0.201 THREAD 1/4-20 UNC
4	33.000	2.250	RND Ø0.201 THREAD 1/4-20 UNC
5	21.000	2.250	RND Ø0.201 THREAD 1/4-20 UNC
6	15.000	2.250	RND Ø0.201 THREAD 1/4-20 UNC
7	9.000	2.250	RND Ø0.201 THREAD 1/4-20 UNC
8	3.000	2.250	RND Ø0.201 THREAD 1/4-20 UNC

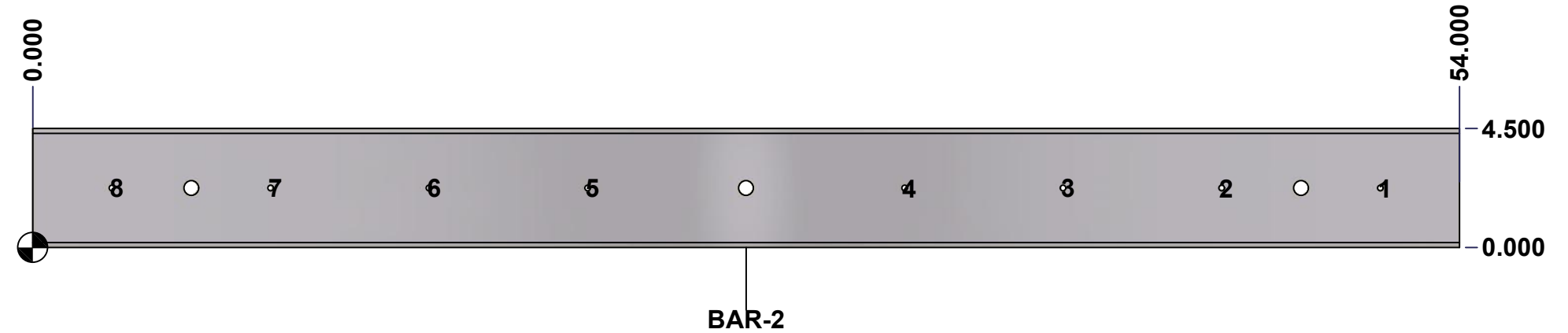

	Description	Status
	Rounded Edge Aluminum Bar 3/8" x 4 1/2"	(NULL)
	Part Number	Rev.
	Numéro Pièce	8
	<b>1412BT061005DTBAR2-P</b>	<b>0</b>
		16



This drawing is confidential and must not be reproduced or used without the consent of Eurobex

Ce dessin est confidentiel et ne doit pas être reproduit ou utilisé sans le consentement de Eurobex

**STANDARD FEATURES ARE NOT LISTED IN THIS HOLE TABLE**

**HOLE TABLE - FRONT VIEW (CUSTOM FEATURE ONLY)**

CUT-OUT	XDIM	YDIM	DESCRIPTION
1	51.000	2.250	RND Ø0.201 THREAD 1/4-20 UNC
2	45.000	2.250	RND Ø0.201 THREAD 1/4-20 UNC
3	39.000	2.250	RND Ø0.201 THREAD 1/4-20 UNC
4	33.000	2.250	RND Ø0.201 THREAD 1/4-20 UNC
5	21.000	2.250	RND Ø0.201 THREAD 1/4-20 UNC
6	15.000	2.250	RND Ø0.201 THREAD 1/4-20 UNC
7	9.000	2.250	RND Ø0.201 THREAD 1/4-20 UNC
8	3.000	2.250	RND Ø0.201 THREAD 1/4-20 UNC

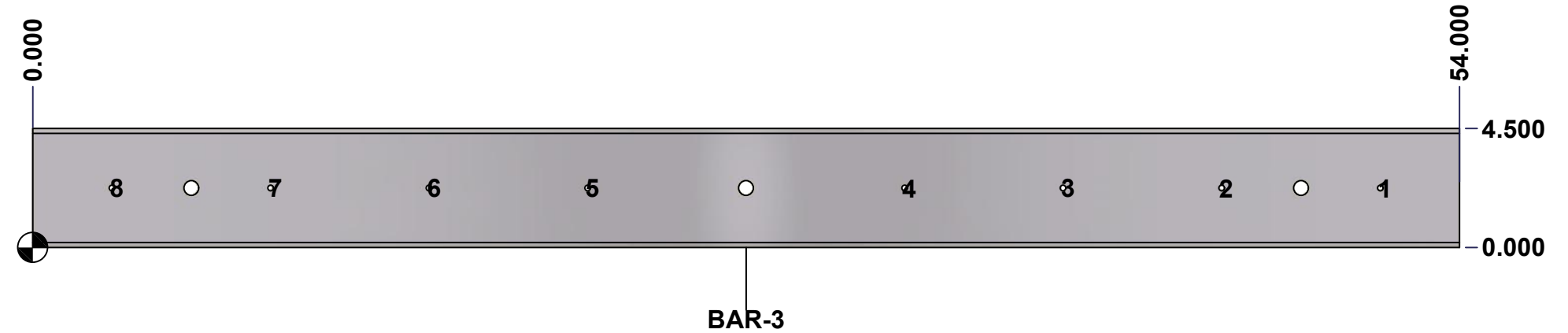

	Description	Status
	Rounded Edge Aluminum Bar 3/8" x 4 1/2"	(NULL)
	Part Number	Rev.
	Numéro Pièce	9
	<b>1412BT061005DTBAR3-P</b>	<b>0</b>
		16

This drawing is confidential and must not be reproduced or used without the consent of Eurobex

Ce dessin est confidentiel et ne doit pas être reproduit ou utilisé sans le consentement de Eurobex

**STANDARD FEATURES ARE NOT LISTED IN THIS HOLE TABLE**

**HOLE TABLE - FRONT VIEW (CUSTOM FEATURE ONLY)**

CUT-OUT	XDIM	YDIM	DESCRIPTION
1	51.000	2.250	RND Ø0.201 THREAD 1/4-20 UNC
2	45.000	2.250	RND Ø0.201 THREAD 1/4-20 UNC
3	39.000	2.250	RND Ø0.201 THREAD 1/4-20 UNC
4	33.000	2.250	RND Ø0.201 THREAD 1/4-20 UNC
5	21.000	2.250	RND Ø0.201 THREAD 1/4-20 UNC
6	15.000	2.250	RND Ø0.201 THREAD 1/4-20 UNC
7	9.000	2.250	RND Ø0.201 THREAD 1/4-20 UNC
8	3.000	2.250	RND Ø0.201 THREAD 1/4-20 UNC

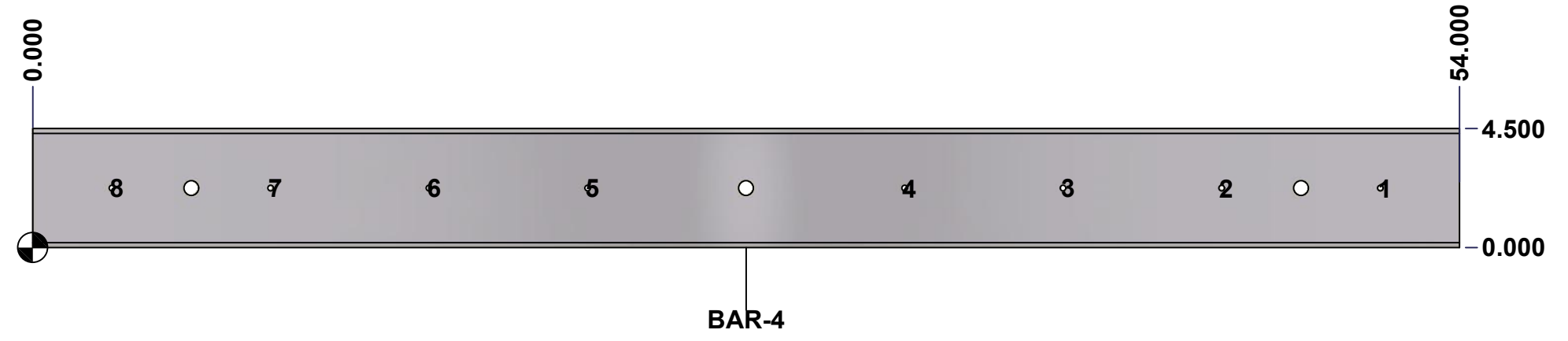

	Description	Status
	Rounded Edge Aluminum Bar 3/8" x 4 1/2"	(NULL)
	Part Number	Rev.
	Numéro Pièce	10
	<b>1412BT061005DTBAR4-P</b>	<b>0</b>
		16

This drawing is confidential and must not be reproduced or used without the consent of Eurobex

Ce dessin est confidentiel et ne doit pas être reproduit ou utilisé sans le consentement de Eurobex

**STANDARD FEATURES ARE NOT LISTED IN THIS HOLE TABLE**

**HOLE TABLE - FRONT VIEW (CUSTOM FEATURE ONLY)**

CUT-OUT	XDIM	YDIM	DESCRIPTION
1	51.000	2.250	RND Ø0.201 THREAD 1/4-20 UNC
2	45.000	2.250	RND Ø0.201 THREAD 1/4-20 UNC
3	39.000	2.250	RND Ø0.201 THREAD 1/4-20 UNC
4	33.000	2.250	RND Ø0.201 THREAD 1/4-20 UNC
5	21.000	2.250	RND Ø0.201 THREAD 1/4-20 UNC
6	15.000	2.250	RND Ø0.201 THREAD 1/4-20 UNC
7	9.000	2.250	RND Ø0.201 THREAD 1/4-20 UNC
8	3.000	2.250	RND Ø0.201 THREAD 1/4-20 UNC

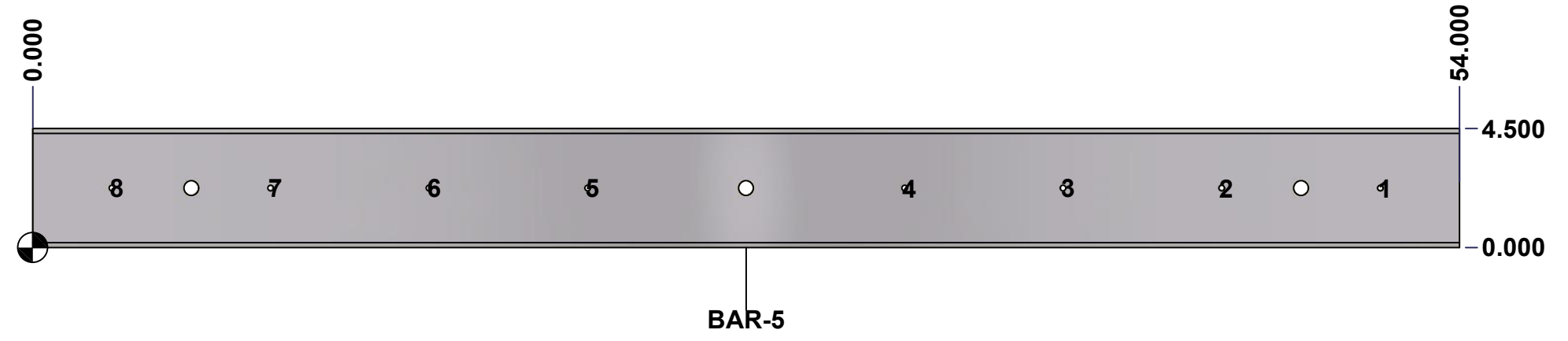

	Description	Status	
	Rounded Edge Aluminum Bar 3/8" x 4 1/2"	(NULL)	
	Part Number	Rev.	11
	Numéro Pièce <b>1412BT061005DTBAR5-P</b>	<b>0</b>	16

This drawing is confidential and must not be reproduced or used without the consent of EXM

Ce dessin est confidentiel et ne doit pas être reproduit ou utilisé sans le consentement de EXM



TOP



BACK



BOTTOM

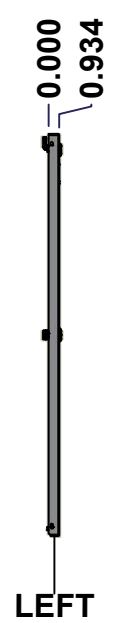

LEFT

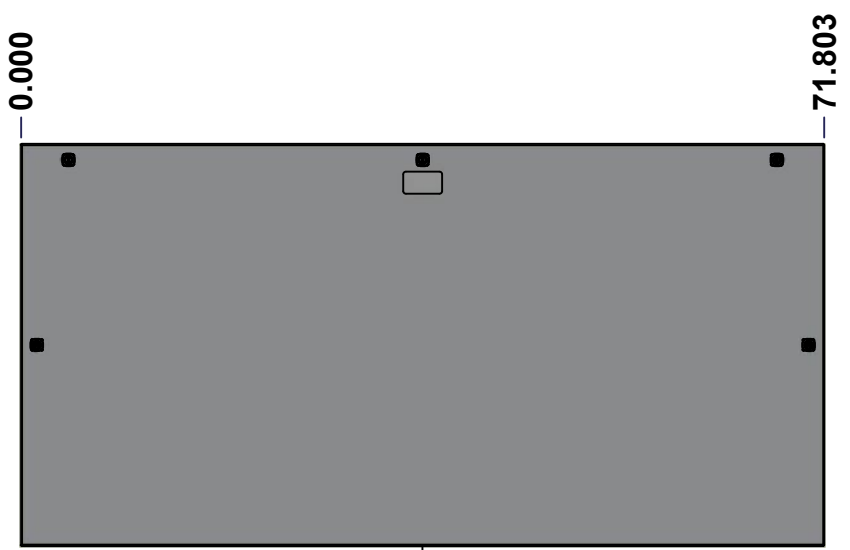

FRONT

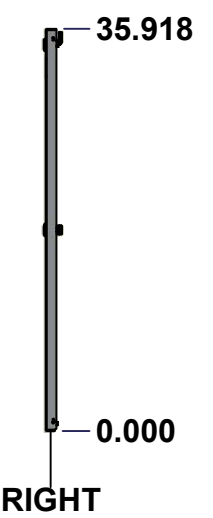

RIGHT

No.	Revisions	Date	By/Par

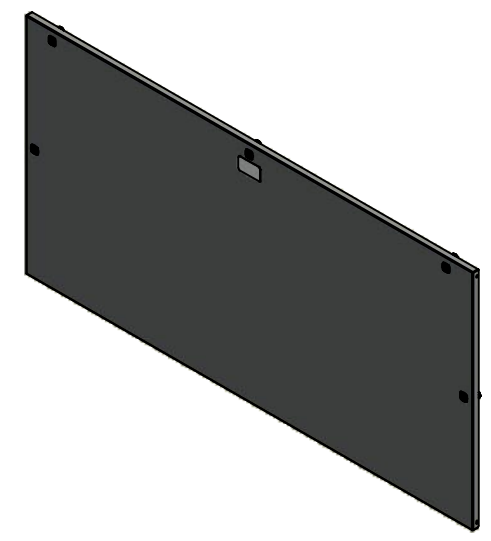

Isometric View

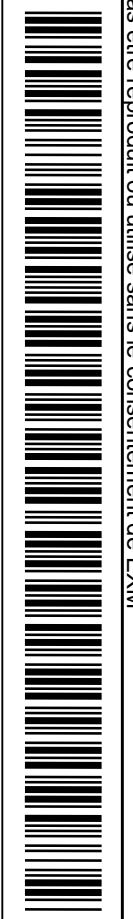

Tél: (450) 979-4373  
 Fax: (450) 979-4626  
[www.exmweb.com](http://www.exmweb.com)

Flatness  
Aplatissement  
Max 3.0mm  
Projection

Customer Client	Date
Drawn By / Dessiné Par: BoxCad: BoxCad	Date: 2022-10-03

Material / Matière: 14 Ga Cold Rolled A1008 CS Type B (1.7mm)

Color / Couleur: Asa-61 Grey	Finish / Fini: Smooth
------------------------------	-----------------------

Description: 1412BT 36" x 72" Cover	Detail Rev.
-------------------------------------	-------------

Part Number / Numéro Pièce: 1412BT061005DTC	Rev. 0	12 / 16
---	--------	---------

SEE BILL OF MATERIAL ON LAST PAGE

This drawing is confidential and must not be reproduced or used without the consent of Eurobox

Ce dessin est confidentiel et ne doit pas être reproduit ou utilisé sans le consentement de Eurobox

**STANDARD FEATURES ARE NOT LISTED IN THIS HOLE TABLE**

**HOLE TABLE - FRONT VIEW (CUSTOM FEATURE ONLY)**

CUT-OUT	XDIM	YDIM	DESCRIPTION
1	1.500	1.486	GND STUD M6 x 16mm (Inside)
2	70.379	17.959	LOCK 880 SCQ4-SL @ 0.0°
3	1.424	17.959	LOCK 880 SCQ4-SL @ 180.0°
4	67.553	34.494	LOCK 880 SCQ4-SL @ 90.0°
5	35.902	34.494	LOCK 880 SCQ4-SL @ 90.0°
6	4.250	34.494	LOCK 880 SCQ4-SL @ 90.0°

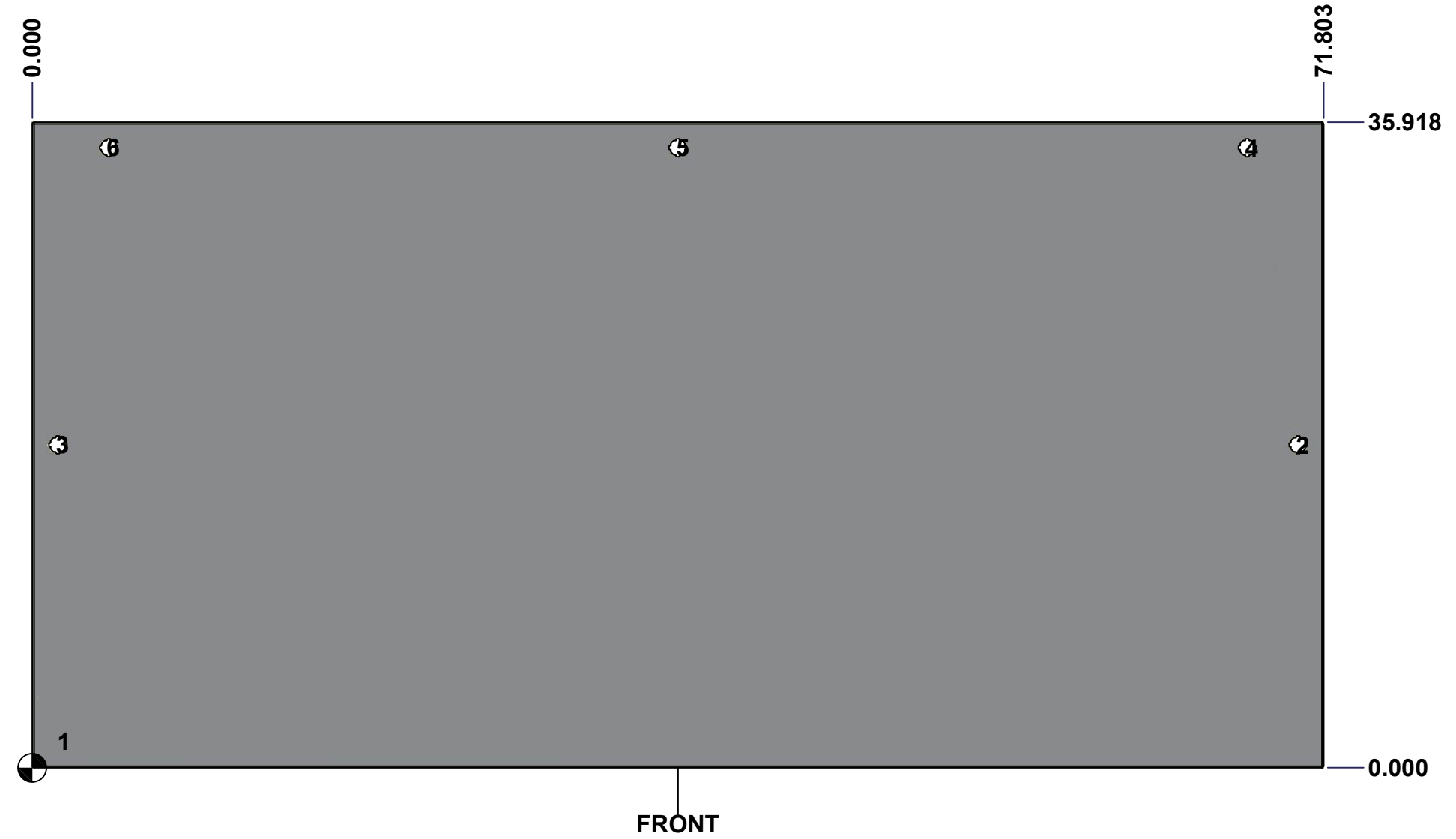

	Description 1412BT 36" x 72" Cover	Status (NULL)
	Part Number Numéro Pièce <b>1412BT061005DTC</b>	Rev. 13 <b>0</b> 16

This drawing is confidential and must not be reproduced or used without the consent of EXM

Ce dessin est confidentiel et ne doit pas être reproduit ou utilisé sans le consentement de EXM

No.	Revisions	Date	By/Par

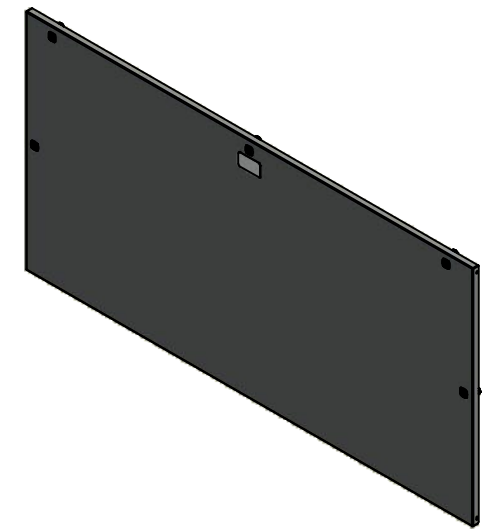

Isometric View

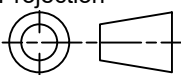

 Tél: (450) 979-4373 Fax: (450) 979-4626 <a href="http://www.exmweb.com">www.exmweb.com</a>	Flatness Aplatissement	Max 3.0mm
	Projection	
Customer Client	Date	
Drawn By Dessiné Par	BoxCad: BoxCad	Date 2022-10-03
Material Matière	14 Ga Cold Rolled A1008 CS Type B (1.7mm)	
Color Couleur	Asa-61 Grey	Finish Fini Smooth
Description	Detail Rev.	
1412BT 36" x 72" Cover		
Part Number Numéro Pièce	Rev. 0	14 / 16
<b>1412BT061005DTC</b>		

Qty	Part Name	Rev	Description
1	1412BT061005DTG	0	1412BT 36" x 72" Cover Gasket
1	STK-P-02400S	0	Powder Paint (Asa-61 Grey / Smooth)
4	STK-K-09800	10	5412 ES Hinge with 2 Captive Hinge Pins
1	STK-Q-16080	0	Ground Stud M6 x 16mm
1	STK-S-00100	0	3.5" x 2" Silver Milar Flexcon Sticker
1	1412BT061005DTC-P	0	1412BT 36" x 72" Cover Part
5	880 SCQ4-SL	6	5412 ES 1/4 Turn Lock
Parts List			

This drawing is confidential and must not be reproduced or used without the consent of EXM

Ce dessin est confidentiel et ne doit pas être reproduit ou utilisé sans le consentement de EXM



TOP

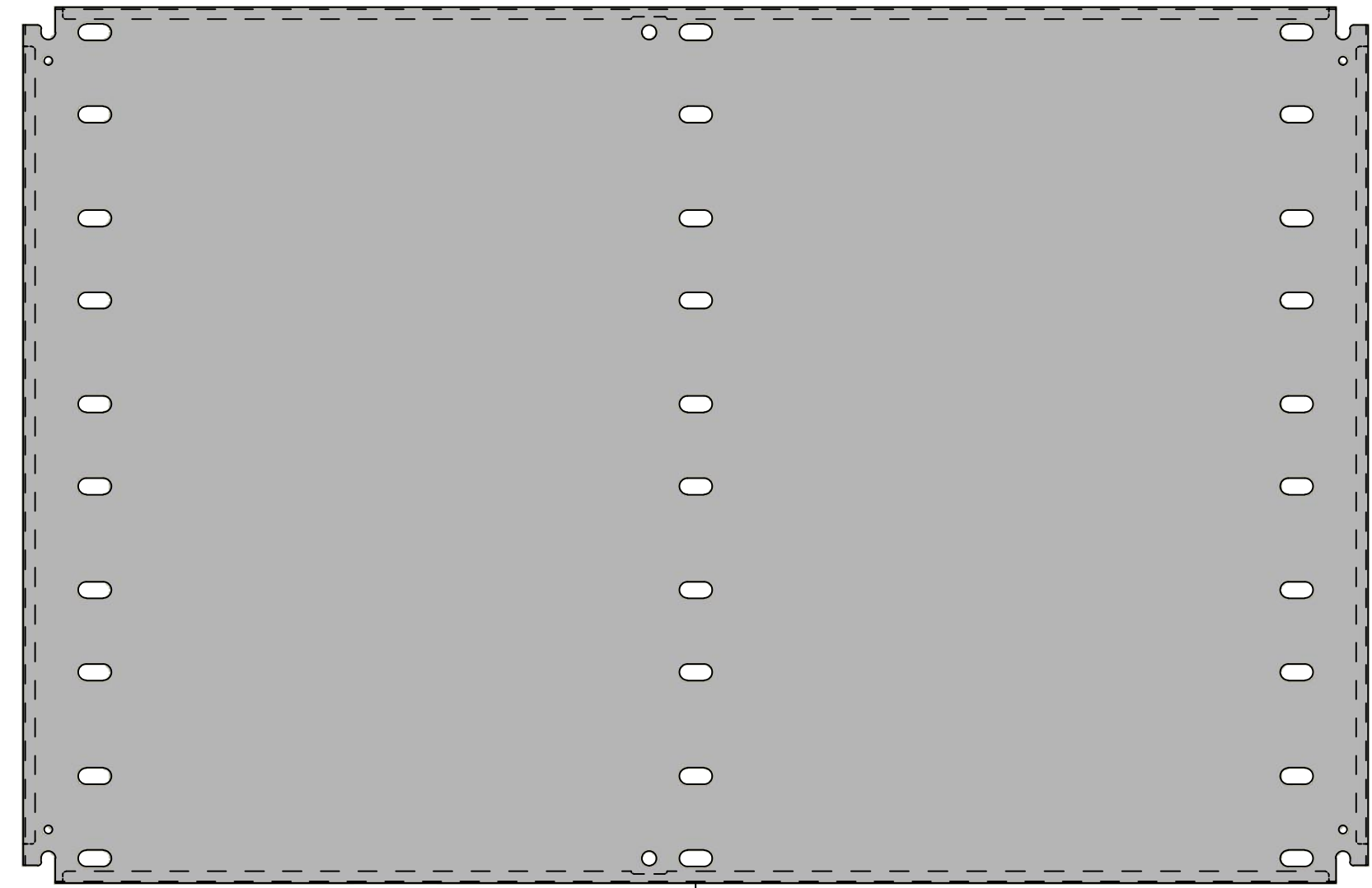

FRONT

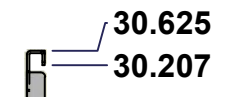

RIGHT

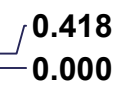

No.	Revisions	Date	By/Par

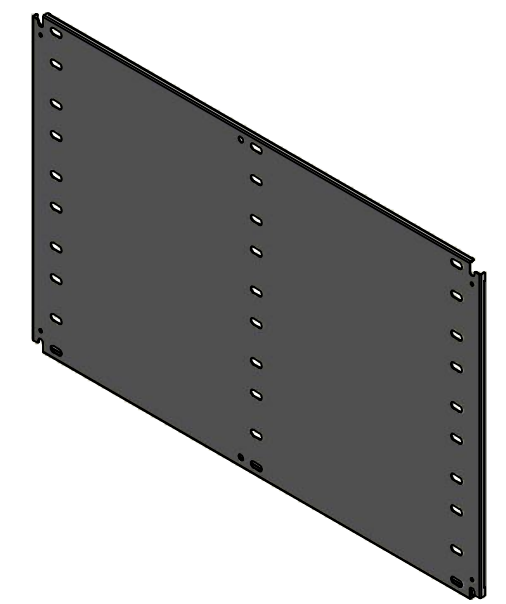

Isometric View

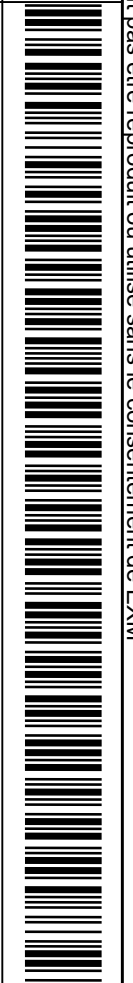

Tél: (450) 979-4373  
 Fax: (450) 979-4626  
[www.exmweb.com](http://www.exmweb.com)

Flatness  
Aplatissement  
Max 3.0mm  
Projection

Customer Client	Date
Drawn By / Dessiné Par: BoxCad: BoxCad	Date: 2022-10-03
Material / Matière: 14 Ga Cold Rolled A1008 CS Type B (1.7mm)	

Color / Couleur: White RAL9003	Finish / Fini: Smooth
--------------------------------	-----------------------

Description: 1412BT 30.625" x 47" Inner Panel	Detail Rev.
---	-------------

Part Number / Numéro Pièce: <b>1412BT061005DTIP1</b>	Rev. <b>0</b>	15 / 16
--	---------------	---------

SEE BILL OF MATERIAL ON LAST PAGE

This drawing is confidential and must not be reproduced or used without the consent of EXM

Ce dessin est confidentiel et ne doit pas être reproduit ou utilisé sans le consentement de EXM

No.	Revisions	Date	By/Par

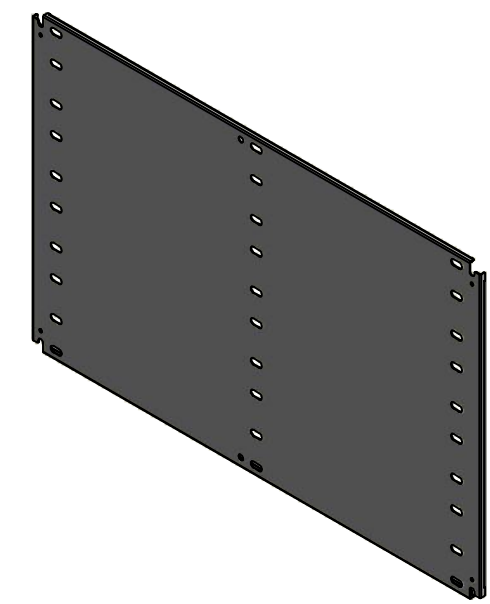

Isometric View

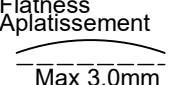

 Tél: (450) 979-4373 Fax: (450) 979-4626 <a href="http://www.exmweb.com">www.exmweb.com</a>		Flatness Aplatissement  Max 3.0mm
Customer Client		Date
Drawn By / Dessiné Par: BoxCad: BoxCad		Date: 2022-10-03
Material / Matière: 14 Ga Cold Rolled A1008 CS Type B (1.7mm)		
Color / Couleur: White RAL9003	Finish / Fini: Smooth	
Description: 1412BT 30.625" x 47" Inner Panel		Detail Rev.
Part Number / Numéro Pièce: <b>1412BT061005DTIP1</b>		Rev. 0 / 16

Qty	Part Number	Rev	Description
1	STK-P-02401S	0	Powder Paint (White / Smooth)
1	1412BT061005DTIP1-P	0	1412BT 30.625" x 72" Inner Panel Part
Parts List			