

This drawing is confidential and must not be reproduced or used without the consent of EXM

Ce dessin est confidentiel et ne doit pas être reproduit ou utilisé sans le consentement de EXM



TOP



LEFT

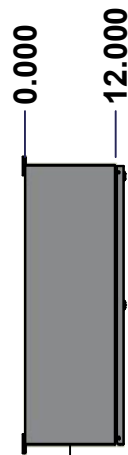

LEFT

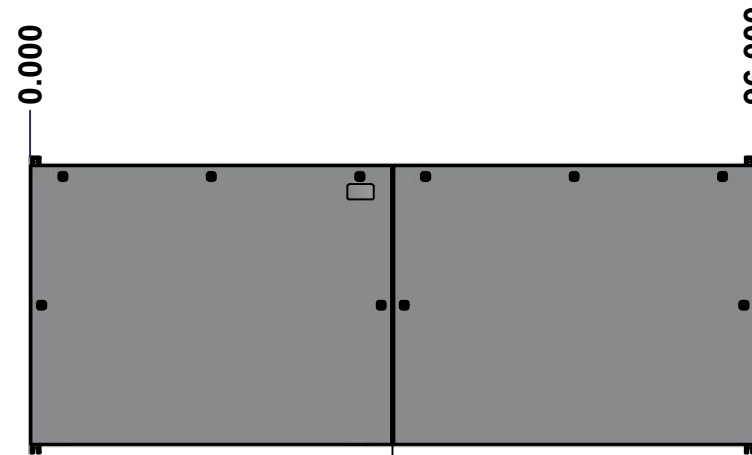

FRONT

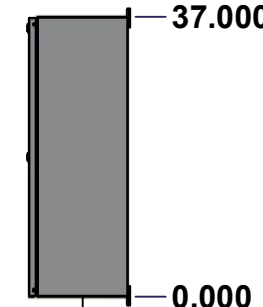

RIGHT



BOTTOM

| No. | Revisions | Date | By/Par |
|-----|-----------|------|--------|
| | | | |
| | | | |
| | | | |
| | | | |
| | | | |

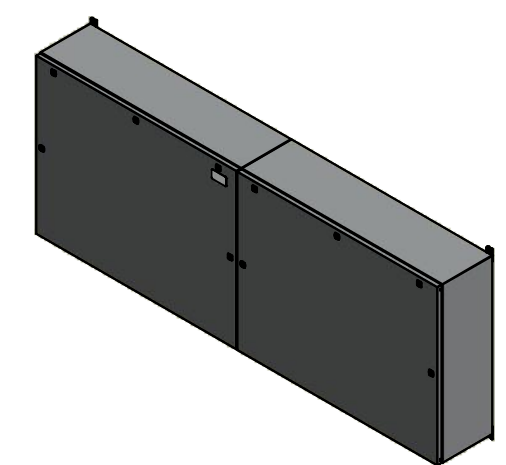

Isometric View

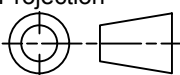

| | | |
|--|---|---|
|  Tél: (450) 979-4373 Fax: (450) 979-4626 www.exmweb.com | | Flatness Aplatissement Max 3.0mm Projection  |
| Customer Client | Date | |
| Drawn By Dessiné Par | BoxCad: BoxCad | Date 22-Sep-22 |
| Material Matière | 14 Ga Cold Rolled A1008 CS Type B (1.7mm) | |
| Color Couleur | Asa-61 Grey | Finish Fini Smooth |
| Description 1412BT 2500A - 4Wires x 96" Assembly | | Detail Rev. |
| Part Number Numéro Pièce | 1412BT082504 | Rev. 0 |

SEE BILL OF MATERIAL ON LAST PAGE

This drawing is confidential and must not be reproduced or used without the consent of Eurobox

STANDARD FEATURES ARE NOT LISTED IN THIS HOLE TABLE

Ce dessin est confidentiel et ne doit pas être reproduit ou utilisé sans le consentement de Eurobox

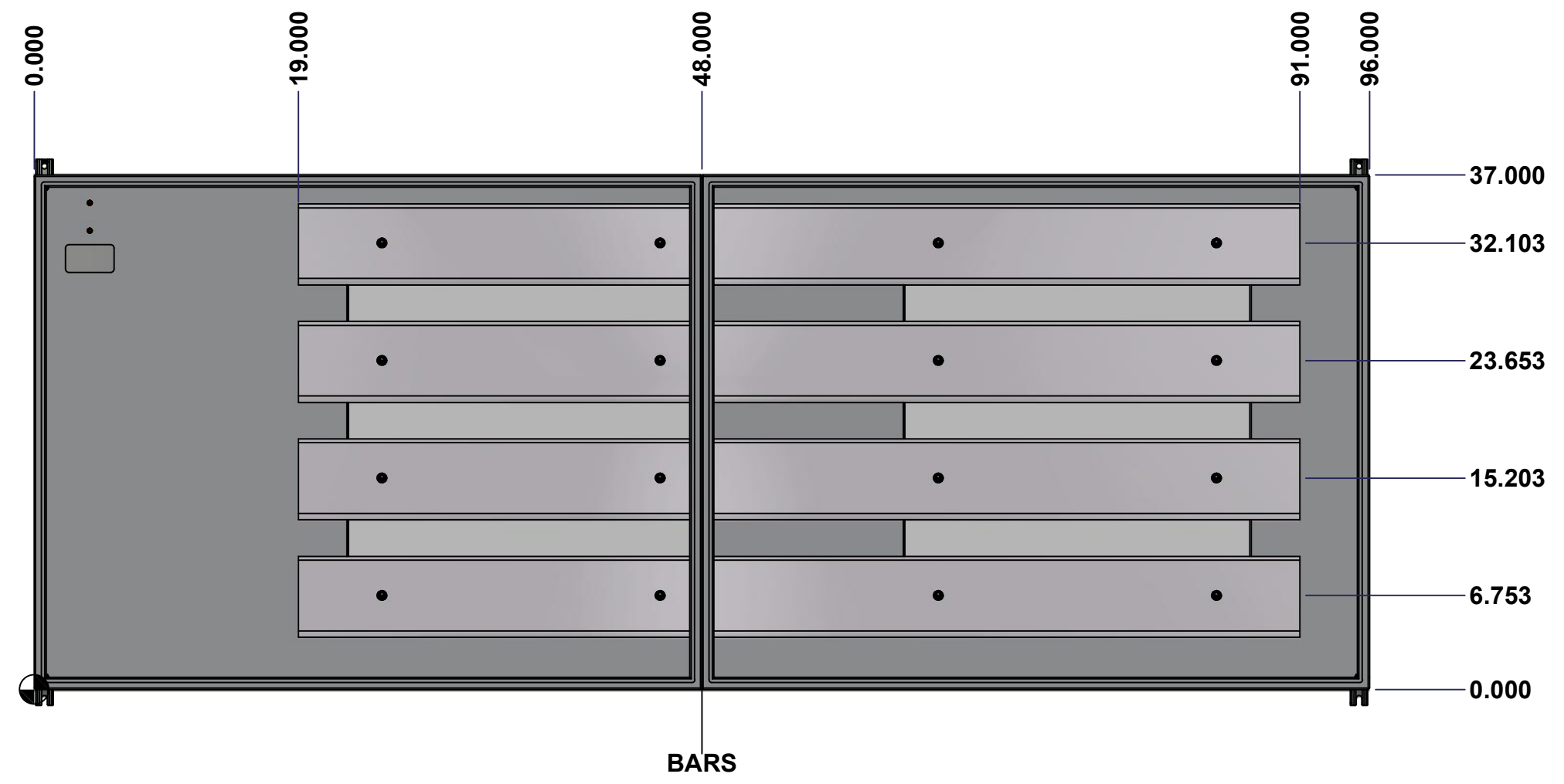

| | | | |
|-----------------------------|--------------------------------------|----------|--------|
| | Description | | Status |
| | 1412BT 2500A - 4Wires x 96" Assembly | | (NULL) |
| Part Number Numéro Pièce | | Rev. | 2 |
| 1412BT082504 | | 0 | 13 |

This drawing is confidential and must not be reproduced or used without the consent of EXM

Ce dessin est confidentiel et ne doit pas être reproduit ou utilisé sans le consentement de EXM

| NOTE | |
|------|--|
| ITEM | DESCRIPTION |
| 1 | NEMA 4/12 Enclosure |
| 2 | C/W Standard ground studs on box and cover |
| 3 | W/O Standard door stiffener |
| 4 | C/W Special inner panel (Sold separately) |
| 5 | C/W Standard inner panel mounting studs |

| No. | Revisions | Date | By/Par |
|-----|-----------|------|--------|
| | | | |
| | | | |
| | | | |
| | | | |
| | | | |

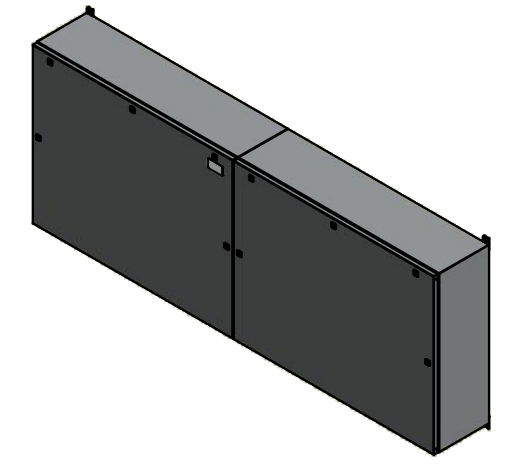

Isometric View

| PACKING | | |
|-----------------------|-----|--|
| ITEM | QTY | DESCRIPTION |
| Cardboard sleeve | 2 | Top and Bottom |
| Cardboard strip | 2 | Between back of enclosure and inner panel |
| Plastic bag | 1 | To protect cover surface and inside gasket |
| Cardboard corner | 4 | To reinforced for the plastic strap tightening |
| Plastic strap - Black | 2 | To Squeeze 2 cardboard sleeve together |
| Packaging label | 3 | White label with PN |
| Plastic strap- Green | 2 | To secure the enclosure to the wood pallet |
| Wood Pallet | 1 | 2" deeper and 3" larger than enclosure size |

| Qty | Part Number | Rev | Description |
|------------|--------------------|-----|--|
| 1 | 885 ESMF1 | 0 | 885 ESMF1 Mounting Feet Kit |
| 1 | 1412BT082504IP2 | 0 | 1412BT 29.975" x 28" Right Inner Panel |
| 1 | 1412BT082504BAR1-P | 0 | Rounded Edge Aluminum Bar 3/4" x 6" |
| 1 | 1412BT082504BAR2-P | 0 | Rounded Edge Aluminum Bar 3/4" x 6" |
| 1 | 1412BT082504BAR3-P | 0 | Rounded Edge Aluminum Bar 3/4" x 6" |
| 1 | 1412BT082504BAR4-P | 0 | Rounded Edge Aluminum Bar 3/4" x 6" |
| 1 | 1412BT082504IP1 | 0 | 1412BT 29.975" x 65" Inner Panel |
| 16 | STK-A-67400 | 0 | Buss Bar Insulator Kit |
| 1 | STK-K-01800 | 5 | 5412 ES Accessory Kit |
| 8 | STK-Q-04050-07 | 7 | M6 x 7mm Hexagon Socket Head Machine Screw with Nyseal |
| 24 | STK-Q-07310 | 2 | Flange Lock Nut M8 |
| 8 | STK-Q-07610 | 8 | M8 Plastic Spacer 22.2mm |
| 1 | 1412BT082504B | 0 | 1412BT 37" x 96" x 12" Body |
| 1 | 1412BT082504C | 0 | 1412BT 37" x 96" Cover |
| | Part Number | Rev | Description |
| Parts List | | | |



Tél: (450) 979-4373
Fax: (450) 979-4626
www.exmweb.com

Flatness
Aplatissement
Max 3.0mm

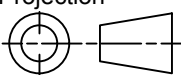
Projection

| | |
|---|-----------------------|
| Customer Client | Date |
| Drawn By Dessiné Par BoxCad: BoxCad | Date 22-Sep-22 |
| Material Matière 14 Ga Cold Rolled A1008 CS Type B (1.7mm) | |
| Color Couleur Asa-61 Grey | Finish Fini Smooth |
| Description 1412BT 2500A - 4Wires x 96" Assembly | Detail Rev. |
| Part Number Numéro Pièce 1412BT082504 | Rev. 0 |

This drawing is confidential and must not be reproduced or used without the consent of EXM

Ce dessin est confidentiel et ne doit pas être reproduit ou utilisé sans le consentement de EXM



TOP



BACK



BOTTOM

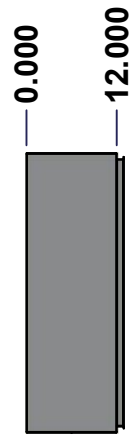

LEFT



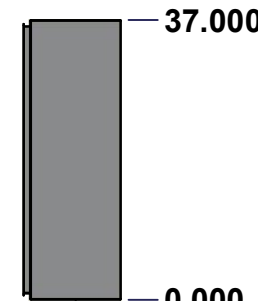

FRONT

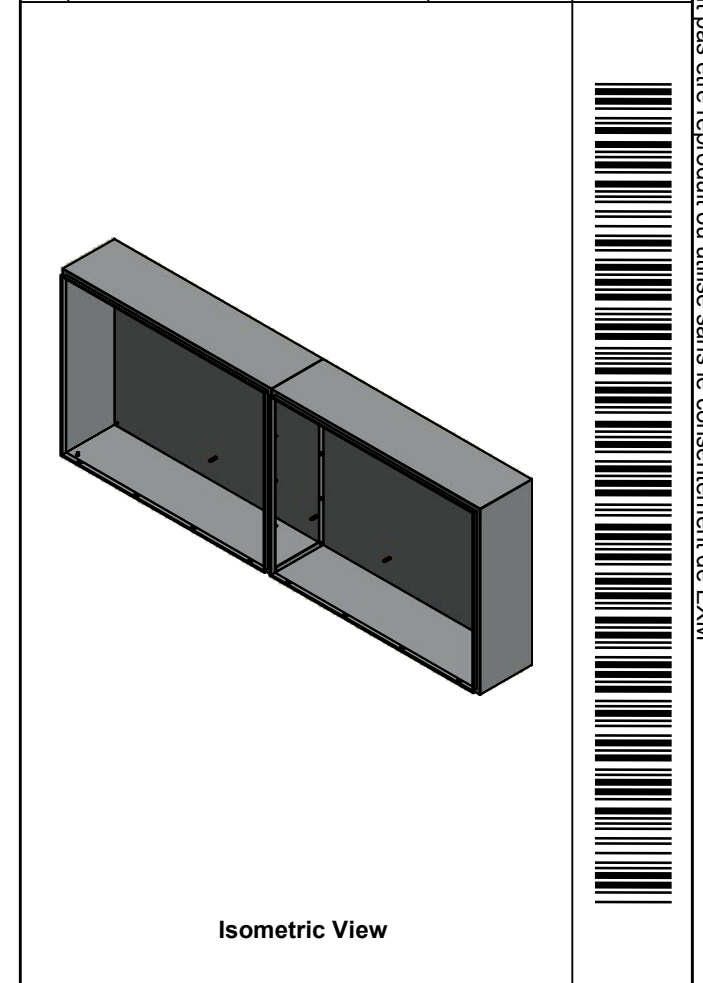

RIGHT

| No. | Revisions | Date | By/Par |
|-----|-----------|------|--------|
| | | | |
| | | | |
| | | | |
| | | | |
| | | | |

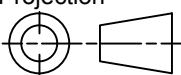

| | | |
|--|---|---|
|  Tél: (450) 979-4373 Fax: (450) 979-4626 www.exmweb.com | | Flatness Aplatissement Max 3.0mm Projection  |
| Customer Client | Date | |
| Drawn By Dessiné Par | BoxCad: BoxCad | Date 22-Sep-22 |
| Material Matière | 14 Ga Cold Rolled A1008 CS Type B (1.7mm) | |
| Color Couleur | Asa-61 Grey | Finish Fini Smooth |
| Description | Detail Rev. | |
| 1412BT 37" x 96" x 12" Body | | |
| Part Number Numéro Pièce | Rev. | 4 |
| 1412BT082504B | 0 | 13 |

SEE BILL OF MATERIAL ON LAST PAGE

This drawing is confidential and must not be reproduced or used without the consent of Eurobox

Ce dessin est confidentiel et ne doit pas être reproduit ou utilisé sans le consentement de Eurobox

| STANDARD FEATURES ARE NOT LISTED IN THIS HOLE TABLE | | | |
|---|--------|--------|-----------------------------|
| HOLE TABLE - BACK VIEW (CUSTOM FEATURE ONLY) | | | |
| CUT-OUT | XDIM | YDIM | DESCRIPTION |
| 1 | 92.000 | 35.000 | GND STUD M8 x 35mm (Inside) |
| 2 | 92.000 | 33.000 | GND STUD M8 x 35mm (Inside) |
| 3 | 9.375 | 33.350 | IP STUD M8 x 35mm (Inside) |
| 4 | 32.625 | 33.350 | IP STUD M8 x 35mm (Inside) |
| 5 | 9.375 | 5.125 | IP STUD M8 x 35mm (Inside) |
| 6 | 32.625 | 5.125 | IP STUD M8 x 35mm (Inside) |
| 7 | 49.375 | 33.350 | IP STUD M8 x 35mm (Inside) |
| 8 | 72.625 | 33.350 | IP STUD M8 x 35mm (Inside) |
| 9 | 49.375 | 5.125 | IP STUD M8 x 35mm (Inside) |
| 10 | 72.625 | 5.125 | IP STUD M8 x 35mm (Inside) |

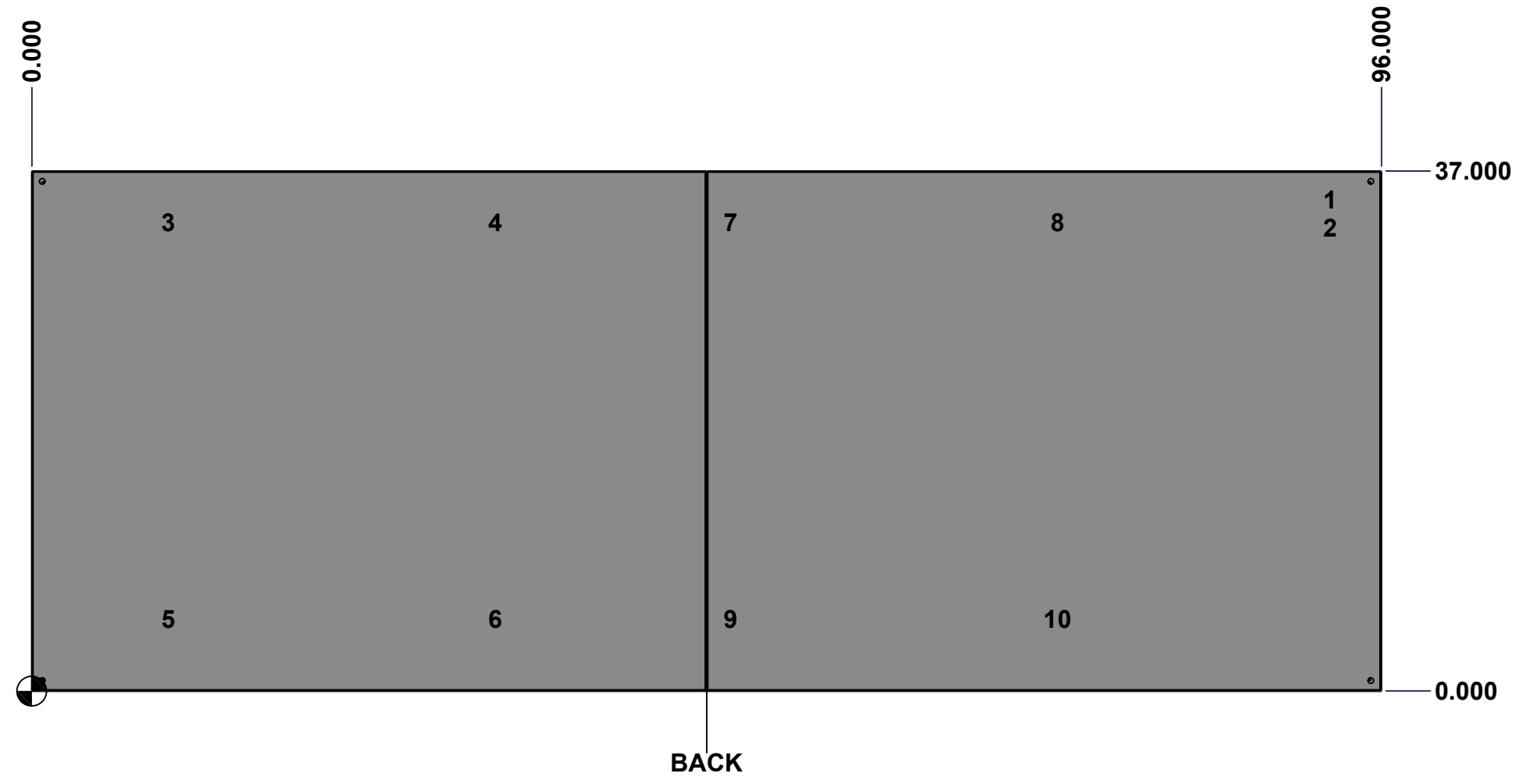

| | | | |
|--|-----------------------------|----------|----|
| | Description | Status | |
| | 1412BT 37" x 96" x 12" Body | (NULL) | |
| | Part Number Numéro Pièce | Rev. | 5 |
| | 1412BT082504B | 0 | 13 |

This drawing is confidential and must not be reproduced or used without the consent of EXM

Ce dessin est confidentiel et ne doit pas être reproduit ou utilisé sans le consentement de EXM

| No. | Revisions | Date | By/Par |
|-----|-----------|------|--------|
| | | | |
| | | | |
| | | | |
| | | | |
| | | | |

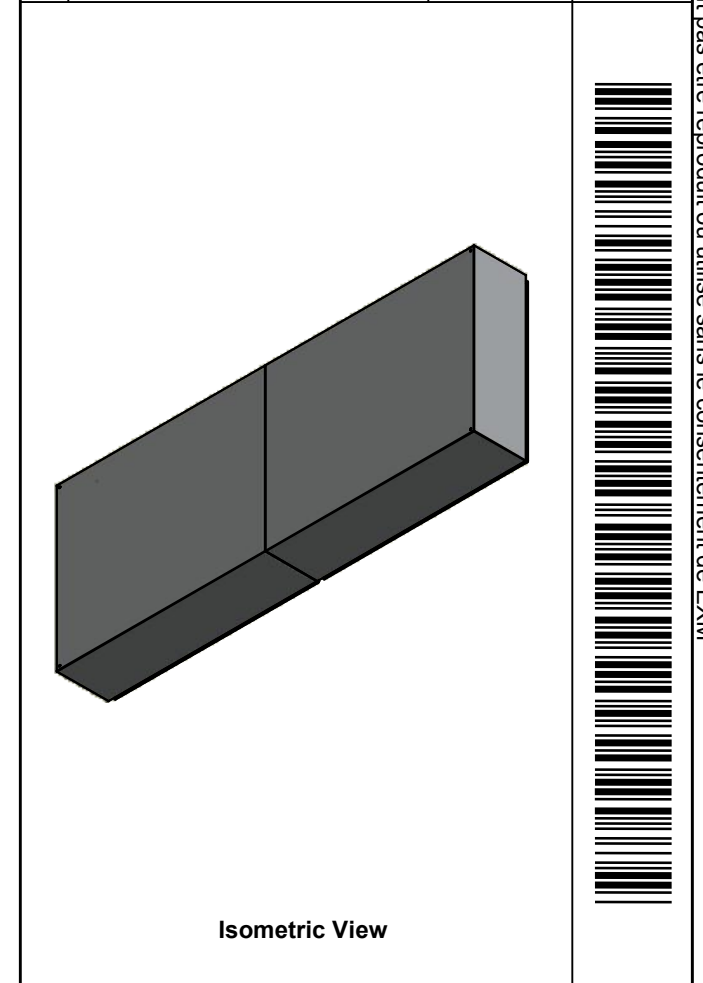

| | |
|--|---|
|  Tél: (450) 979-4373 Fax: (450) 979-4626 www.exmweb.com | Flatness Aplatissement |
| | Max 3.0mm |
| Projection |  |

| | |
|-------------------------|---|
| Customer Client | Date |
| Drawn By Dessiné Par | Date 22-Sep-22 |
| Material Matière | BoxCad: BoxCad |
| | 14 Ga Cold Rolled A1008 CS Type B (1.7mm) |

| | | | |
|-----------------------------|-------------|----------------|--------|
| Color Couleur | Asa-61 Grey | Finish Fini | Smooth |
| Description | | Detail Rev. | |
| 1412BT 37" x 96" x 12" Body | | | |

| | | |
|-----------------------------|----------|----|
| Part Number Numéro Pièce | Rev. | 6 |
| 1412BT082504B | 0 | 13 |

| Qty | Part Number | Rev | Description |
|------------|-----------------|-----|---|
| 1 | STK-P-02400S | 0 | Powder Paint (Asa-61 Grey / Smooth) |
| 1 | 1412BT082504B-P | 0 | 1412BT 37" x 96" x 12" Body Part |
| 1 | 1412BT082504E-P | 0 | 1412BT 37" x 96" x 12" Right Body Part |
| 1 | STK-G-00701 | 0 | 1" x 1/4" Self-Adhesive Neoprene Gasket |
| 10 | STK-Q-00260 | 1 | M6 x 13mm Carriage Bolt |
| 10 | STK-Q-07220 | 1 | M6 Nylon Insert Lock Nut |
| 10 | STK-Q-16005 | 1 | Stud M8 x 35 (No Paint Cap Required) |
| 2 | STK-Q-16080 | 0 | Ground Stud M6 x 16mm |
| 1 | STK-S-00100 | 0 | 3.5" x 2" Silver Milar Flexcon Sticker |
| Parts List | | | |

This drawing is confidential and must not be reproduced or used without the consent of EXM

Ce dessin est confidentiel et ne doit pas être reproduit ou utilisé sans le consentement de EXM



TOP

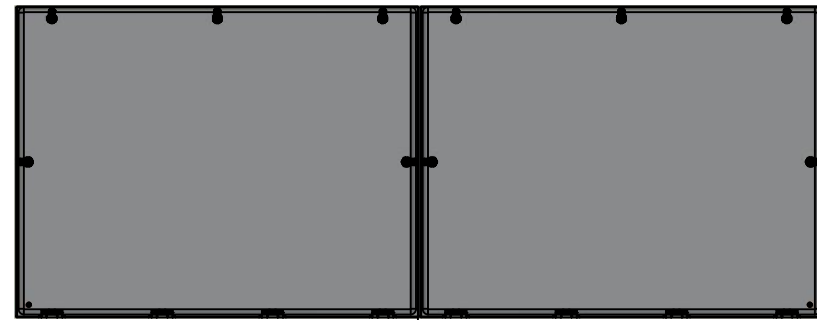

BACK



BOTTOM

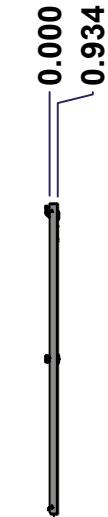

LEFT

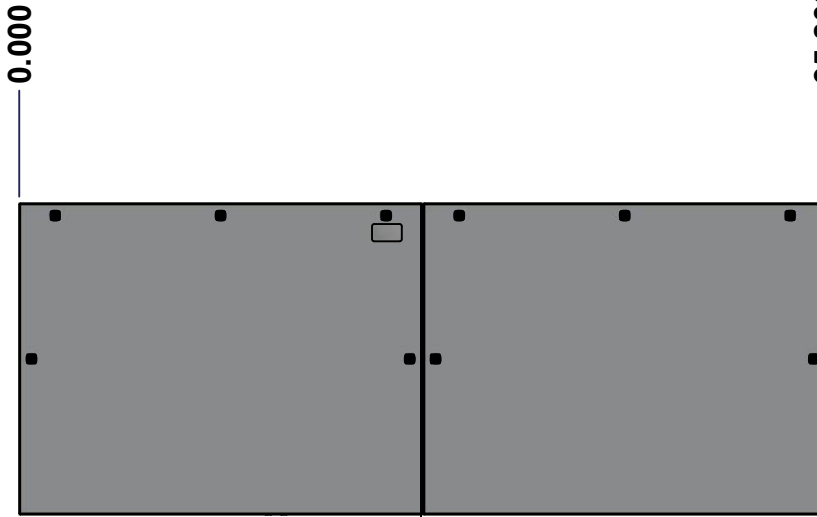

FRONT

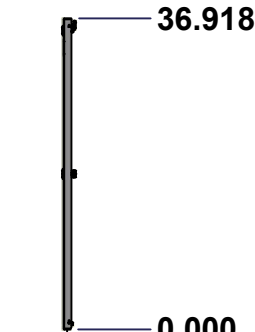

RIGHT

| No. | Revisions | Date | By/Par |
|-----|-----------|------|--------|
| | | | |
| | | | |
| | | | |
| | | | |
| | | | |



Isometric View



Tél: (450) 979-4373
 Fax: (450) 979-4626
www.exmweb.com

Flatness
Aplatissement

Max 3.0mm

Projection

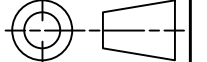

| | |
|---|-----------------------|
| Customer Client | Date |
| Drawn By Dessiné Par BoxCad: BoxCad | Date 22-Sep-22 |
| Material Matière 14 Ga Cold Rolled A1008 CS Type B (1.7mm) | |
| Color Couleur Asa-61 Grey | Finish Fini Smooth |
| Description 1412BT 37" x 96" Cover | Detail Rev. |
| Part Number Numéro Pièce 1412BT082504C | Rev. 0 |

SEE BILL OF MATERIAL ON LAST PAGE

This drawing is confidential and must not be reproduced or used without the consent of Eurobox

Ce dessin est confidentiel et ne doit pas être reproduit ou utilisé sans le consentement de Eurobox

STANDARD FEATURES ARE NOT LISTED IN THIS HOLE TABLE

HOLE TABLE - FRONT VIEW (CUSTOM FEATURE ONLY)

| CUT-OUT | XDIM | YDIM | DESCRIPTION |
|---------|--------|--------|-----------------------------|
| 1 | 1.500 | 1.486 | GND STUD M6 x 16mm (Inside) |
| 2 | 94.303 | 1.486 | GND STUD M6 x 16mm (Inside) |
| 3 | 94.379 | 18.459 | LOCK 880 SCQ4-SL @ 0.0° |
| 4 | 49.424 | 18.459 | LOCK 880 SCQ4-SL @ 180.0° |
| 5 | 46.379 | 18.459 | LOCK 880 SCQ4-SL @ 0.0° |
| 6 | 1.424 | 18.459 | LOCK 880 SCQ4-SL @ 180.0° |
| 7 | 91.553 | 35.494 | LOCK 880 SCQ4-SL @ 90.0° |
| 8 | 71.902 | 35.494 | LOCK 880 SCQ4-SL @ 90.0° |
| 9 | 52.250 | 35.494 | LOCK 880 SCQ4-SL @ 90.0° |
| 10 | 43.553 | 35.494 | LOCK 880 SCQ4-SL @ 90.0° |
| 11 | 23.902 | 35.494 | LOCK 880 SCQ4-SL @ 90.0° |
| 12 | 4.250 | 35.494 | LOCK 880 SCQ4-SL @ 90.0° |

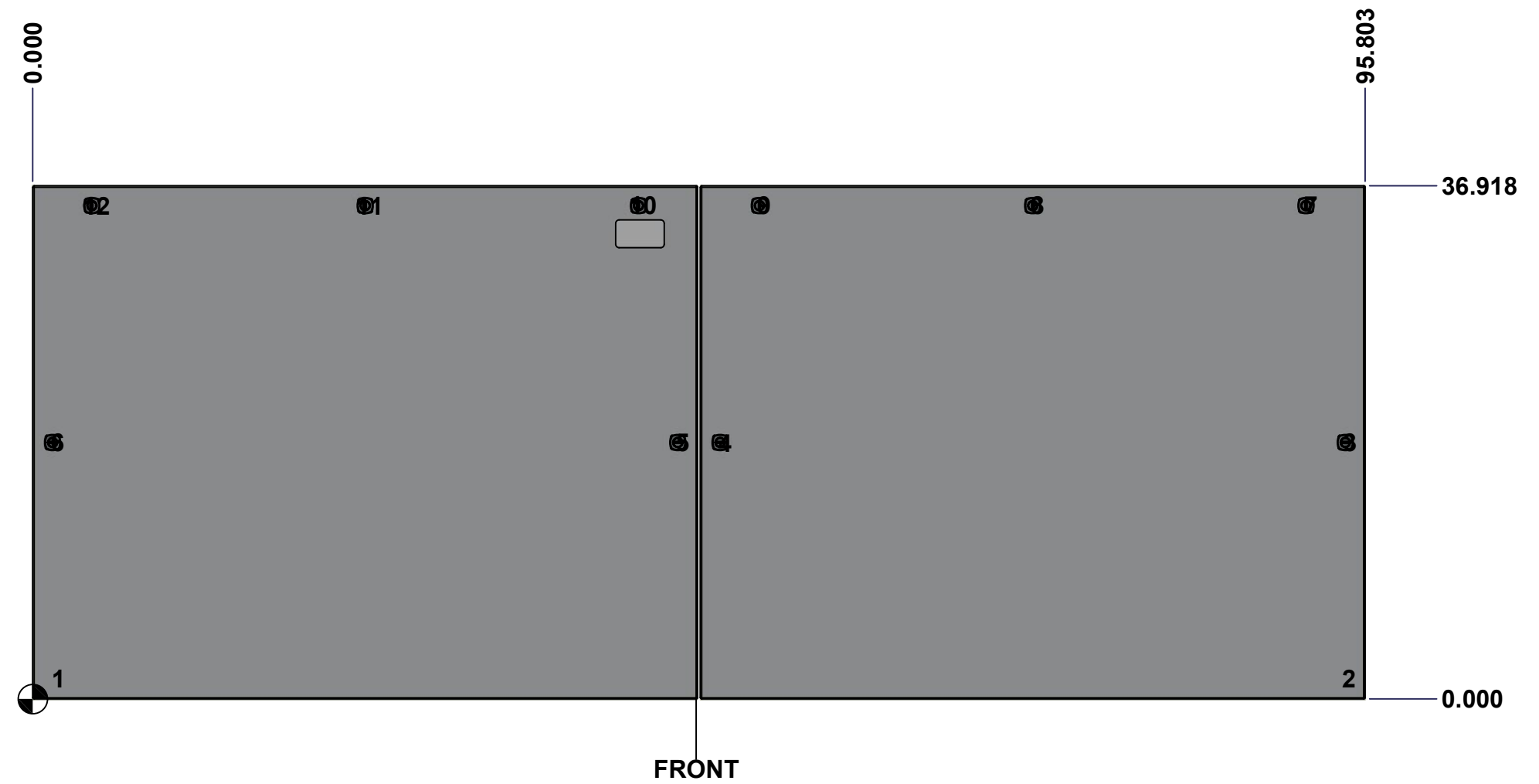

FRONT

| | | |
|--|---|--------------------|
| | Description 1412BT 37" x 96" Cover | Status (NULL) |
| | Part Number Numéro Pièce 1412BT082504C | Rev. 8 0 |

This drawing is confidential and must not be reproduced or used without the consent of EXM

Ce dessin est confidentiel et ne doit pas être reproduit ou utilisé sans le consentement de EXM

| No. | Revisions | Date | By/Par |
|-----|-----------|------|--------|
| | | | |
| | | | |
| | | | |
| | | | |
| | | | |

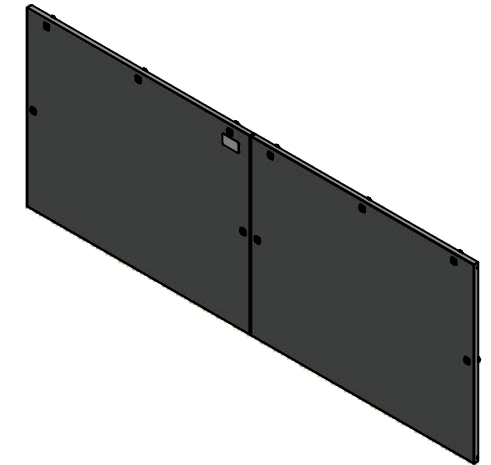

Isometric View



Tél: (450) 979-4373
 Fax: (450) 979-4626
www.exmweb.com

Flatness
Aplatissement

Max 3.0mm

Projection

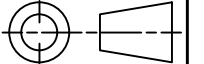

| | |
|---|-----------------|
| Customer Client | Date |
| Drawn By / Dessiné Par: BoxCad: BoxCad | Date: 22-Sep-22 |
| Material / Matière: 14 Ga Cold Rolled A1008 CS Type B (1.7mm) | |

| | |
|------------------------------|-----------------------|
| Color / Couleur: Asa-61 Grey | Finish / Fini: Smooth |
|------------------------------|-----------------------|

| | |
|-------------------------------------|-------------|
| Description: 1412BT 37" x 96" Cover | Detail Rev. |
|-------------------------------------|-------------|

| | | |
|--|--------|---|
| Part Number / Numéro Pièce: 1412BT082504C | Rev. 0 | 9 |
|--|--------|---|

| Qty | Part Name | Rev | Description |
|------------|-----------------|-----|---|
| 2 | 1412BT082504G | 0 | 1412BT 37" x 96" Cover Gasket |
| 1 | STK-P-02400S | 0 | Powder Paint (Asa-61 Grey / Smooth) |
| 8 | STK-K-09800 | 10 | 5412 ES Hinge with 2 Captive Hinge Pins |
| 2 | STK-Q-16080 | 0 | Ground Stud M6 x 16mm |
| 1 | STK-S-00100 | 0 | 3.5" x 2" Silver Milar Flexcon Sticker |
| 1 | 1412BT082504C-P | 0 | 1412BT 37" x 96" Cover Part |
| 1 | 1412BT082504F-P | 0 | 1412BT 37" x 96" Right Cover Part |
| 10 | 880 SCQ4-SL | 6 | 5412 ES 1/4 Turn Lock |
| Parts List | | | |

This drawing is confidential and must not be reproduced or used without the consent of EXM

Ce dessin est confidentiel et ne doit pas être reproduit ou utilisé sans le consentement de EXM

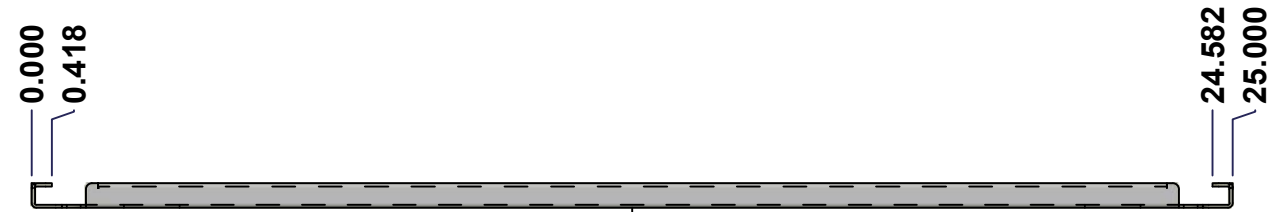

TOP

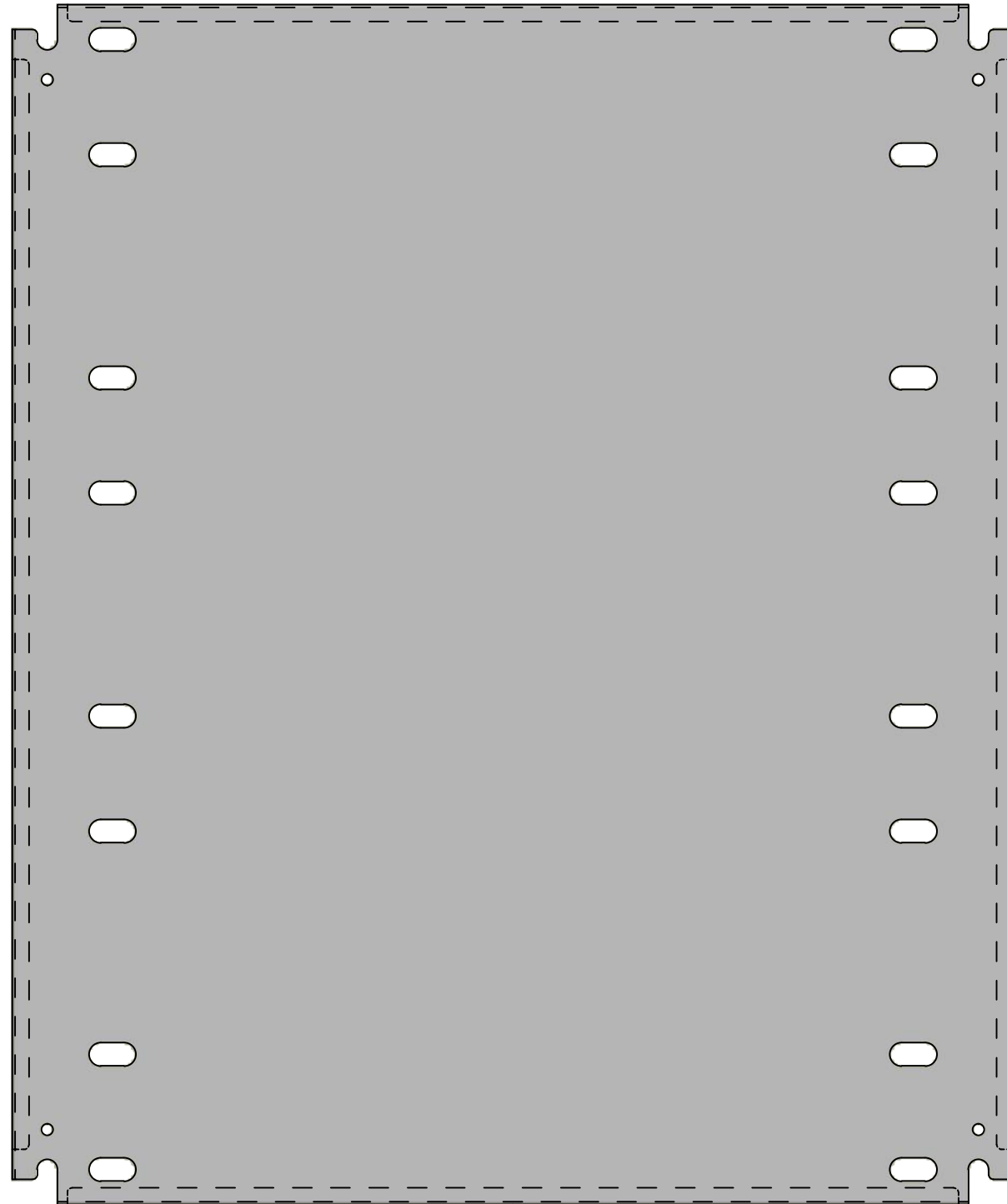

FRONT

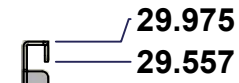

RIGHT

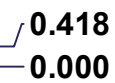

SEE BILL OF MATERIAL ON LAST PAGE

| No. | Revisions | Date | By/Par |
|-----|-----------|------|--------|
| | | | |
| | | | |
| | | | |
| | | | |
| | | | |

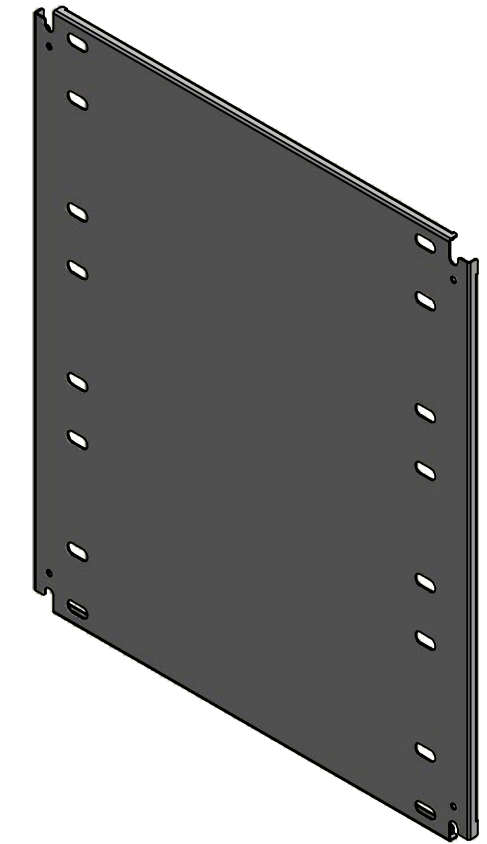

Isometric View



Tél: (450) 979-4373
 Fax: (450) 979-4626
www.exmweb.com

Flatness
Aplatissement

Max 3.0mm

Projection

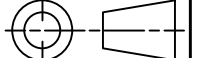

| | |
|---|-----------------|
| Customer Client | Date |
| Drawn By / Dessiné Par: BoxCad: BoxCad | Date: 22-Sep-22 |
| Material / Matière: 14 Ga Cold Rolled A1008 CS Type B (1.7mm) | |

| | |
|--------------------------------|-----------------------|
| Color / Couleur: White RAL9003 | Finish / Fini: Smooth |
|--------------------------------|-----------------------|

| | |
|---|-------------|
| Description: 1412BT 29.975" x 65" Inner Panel | Detail Rev. |
|---|-------------|

| | | | |
|---|--------|----|----|
| Part Number / Numéro Pièce: 1412BT082504IP1 | Rev. 0 | 10 | 13 |
|---|--------|----|----|

This drawing is confidential and must not be reproduced or used without the consent of EXM

Ce dessin est confidentiel et ne doit pas être reproduit ou utilisé sans le consentement de EXM

| No. | Revisions | Date | By/Par |
|-----|-----------|------|--------|
| | | | |
| | | | |
| | | | |
| | | | |
| | | | |

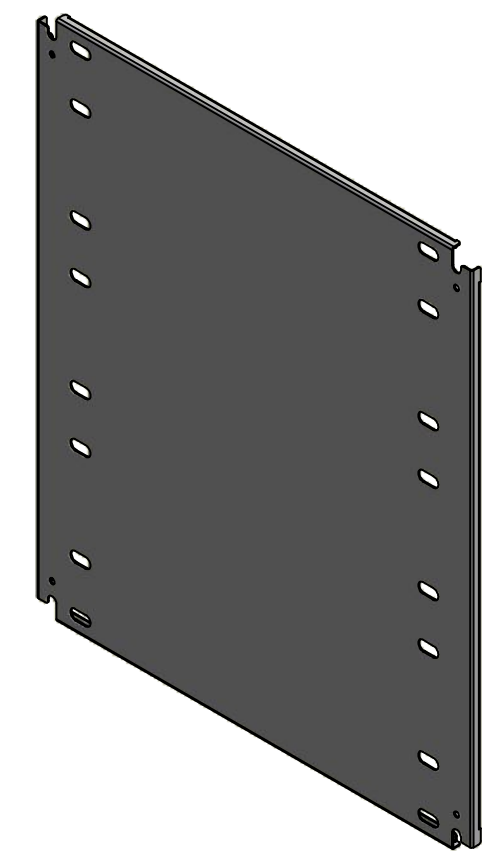

Isometric View

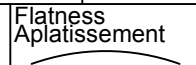

| | | | |
|--|--|---|-------------|
|  Tél: (450) 979-4373 Fax: (450) 979-4626 www.exmweb.com | | Flatness Aplatissement  Max 3.0mm | |
| Customer Client | | Date | |
| Drawn By Dessiné Par BoxCad: BoxCad | | Date 22-Sep-22 | |
| Material Matière 14 Ga Cold Rolled A1008 CS Type B (1.7mm) | | | |
| Color Couleur White RAL9003 | | Finish Fini Smooth | |
| Description 1412BT 29.975" x 65" Inner Panel | | | Detail Rev. |
| Part Number Numéro Pièce 1412BT082504IP1 | | Rev. 0 | 11 13 |

| Qty | Part Number | Rev | Description |
|------------|-------------------|-----|---------------------------------------|
| 1 | STK-P-02401S | 0 | Powder Paint (White / Smooth) |
| 1 | 1412BT082504IP1-P | 0 | 1412BT 29.975" x 96" Inner Panel Part |
| Parts List | | | |

This drawing is confidential and must not be reproduced or used without the consent of EXM

Ce dessin est confidentiel et ne doit pas être reproduit ou utilisé sans le consentement de EXM

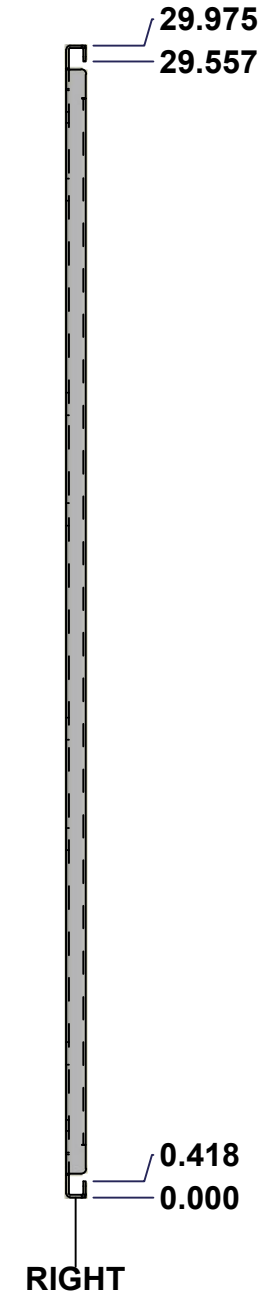
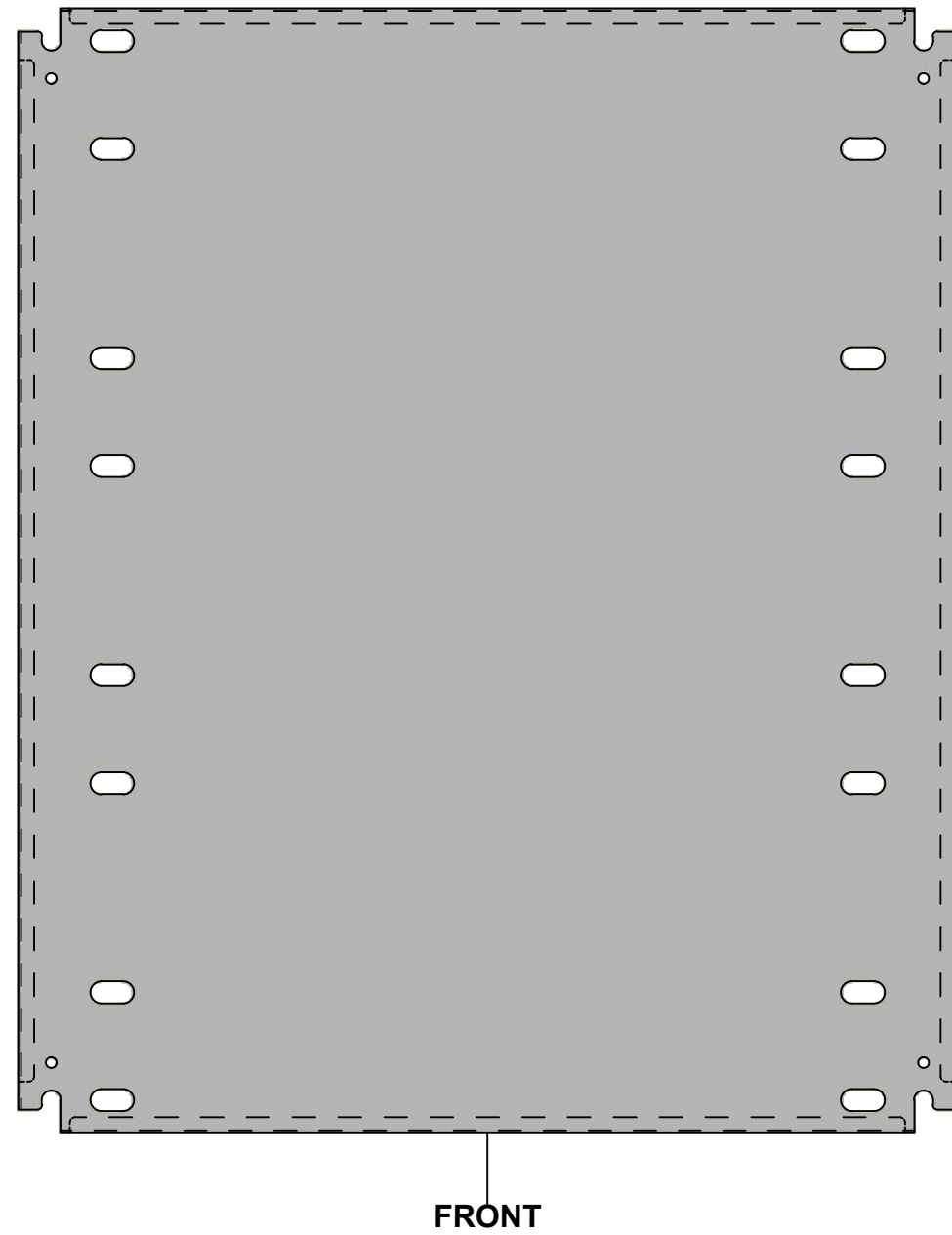
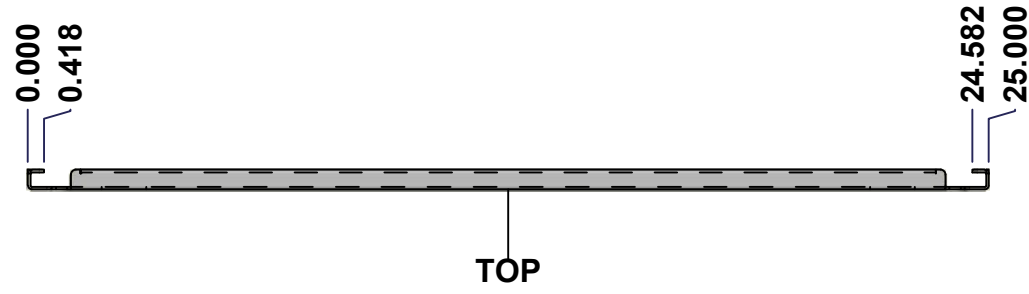

| No. | Revisions | Date | By/Par |
|-----|-----------|------|--------|
| | | | |
| | | | |
| | | | |
| | | | |
| | | | |

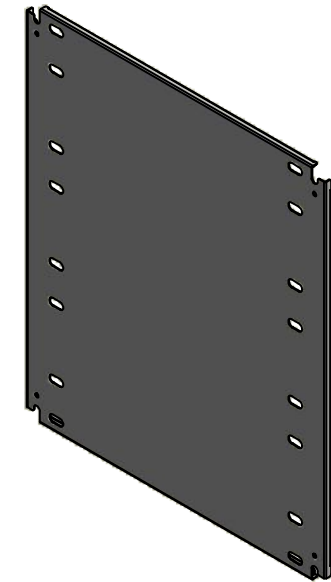

Isometric View



Tél: (450) 979-4373
Fax: (450) 979-4626
www.exmweb.com

Flatness
Aplatissement

Max 3.0mm

Projection

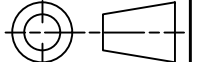

| | |
|---|-----------------------|
| Customer Client | Date |
| Drawn By / Dessiné Par: BoxCad: BoxCad | Date: 22-Sep-22 |
| Material / Matière: 14 Ga Cold Rolled A1008 CS Type B (1.7mm) | |
| Color / Couleur: White RAL9003 | Finish / Fini: Smooth |

| | |
|---|-------------|
| Description: 1412BT 29.975" x 28" Right Inner Panel | Detail Rev. |
|---|-------------|

| | | |
|---|--------|---------|
| Part Number / Numéro Pièce: 1412BT082504IP2 | Rev. 0 | 12 / 13 |
|---|--------|---------|

SEE BILL OF MATERIAL ON LAST PAGE

This drawing is confidential and must not be reproduced or used without the consent of EXM

Ce dessin est confidentiel et ne doit pas être reproduit ou utilisé sans le consentement de EXM

| No. | Revisions | Date | By/Par |
|-----|-----------|------|--------|
| | | | |
| | | | |
| | | | |
| | | | |
| | | | |

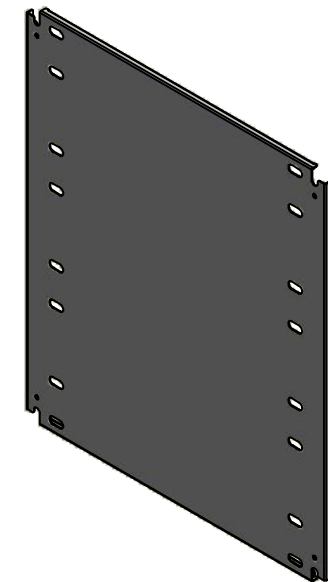

Isometric View

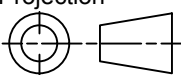

| | | |
|--|-----------------------|---|
|  Tél: (450) 979-4373 Fax: (450) 979-4626 www.exmweb.com | | Flatness Aplatissement Max 3.0mm Projection  |
| Customer Client | Date | |
| Drawn By / Dessiné Par: BoxCad: BoxCad | Date: 22-Sep-22 | |
| Material / Matière: 14 Ga Cold Rolled A1008 CS Type B (1.7mm) | | |
| Color / Couleur: White RAL9003 | Finish / Fini: Smooth | |
| Description: 1412BT 29.975" x 28" Right Inner Panel | | Detail Rev. |
| Part Number / Numéro Pièce: 1412BT082504IP2 | Rev.: | 13 |
| | | 0 |

| Qty | Part Number | Rev | Description |
|------------|-------------------|-----|---|
| 1 | STK-P-02401S | 0 | Powder Paint (White / Smooth) |
| 1 | 1412BT082504IP2-P | 0 | 1412BT 29.975" x 96" Right Inner Panel Part |
| Parts List | | | |