

This drawing is confidential and must not be reproduced or used without the consent of EXM

Ce dessin est confidentiel et ne doit pas être reproduit ou utilisé sans le consentement de EXM

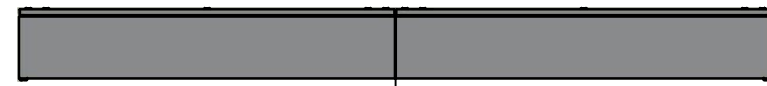

TOP



LEFT

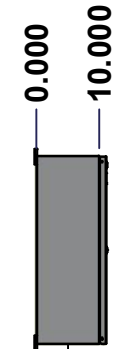

LEFT

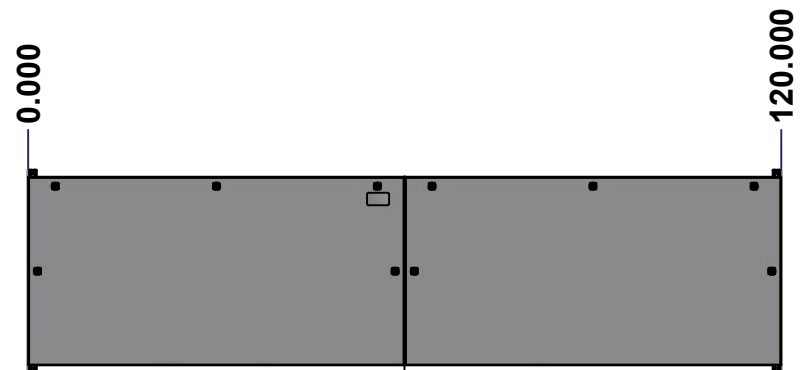

FRONT

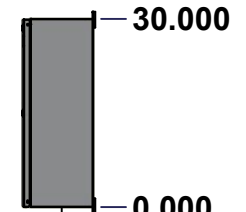

RIGHT



BOTTOM

No.	Revisions	Date	By/Par

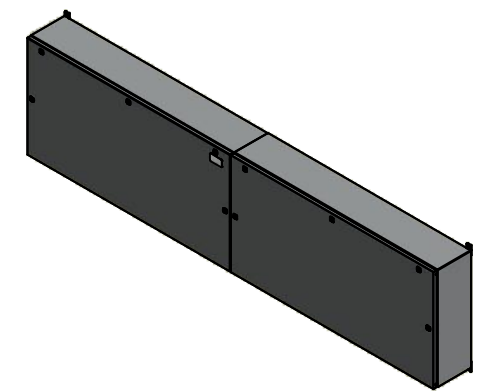

Isometric View



Tél: (450) 979-4373  
 Fax: (450) 979-4626  
[www.exmweb.com](http://www.exmweb.com)

Flatness  
Aplatissement  
Max 3.0mm  
Projection

Customer Client	Date
Drawn By Dessiné Par BoxCad: BoxCad	Date 04-Oct-22
Material Matière 14 Ga Cold Rolled A1008 CS Type B (1.7mm)	
Color Couleur Asa-61 Grey	Finish Fini Smooth
Description 1412BT 1200A - 4Wires x 120" Assembly	Detail Rev.
Part Number Numéro Pièce <b>1412BT101204DT</b>	Rev. <b>0</b>

SEE BILL OF MATERIAL ON LAST PAGE

This drawing is confidential and must not be reproduced or used without the consent of Eurobox

**STANDARD FEATURES ARE NOT LISTED IN THIS HOLE TABLE**

Ce dessin est confidentiel et ne doit pas être reproduit ou utilisé sans le consentement de Eurobox

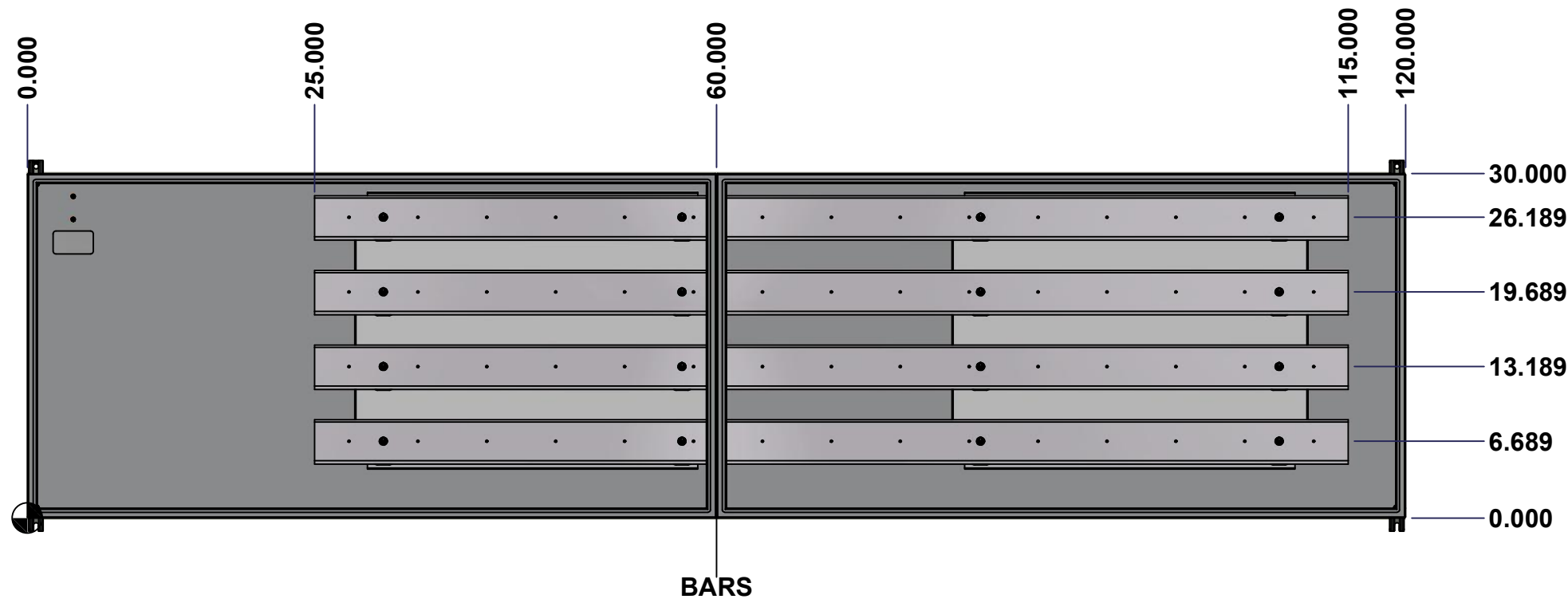

	Description		Status
	1412BT 1200A - 4Wires x 120" Assembly		(NULL)
Part Number Numéro Pièce		Rev.	2
<b>1412BT101204DT</b>		<b>0</b>	17

This drawing is confidential and must not be reproduced or used without the consent of EXM

Ce dessin est confidentiel et ne doit pas être reproduit ou utilisé sans le consentement de EXM

NOTE	
ITEM	DESCRIPTION
1	NEMA 4/12 Enclosure
2	C/W Standard ground studs on box and cover
3	W/O Standard door stiffener
4	C/W Special inner panel (Sold separately)
5	C/W Standard inner panel mounting studs

No.	Revisions	Date	By/Par

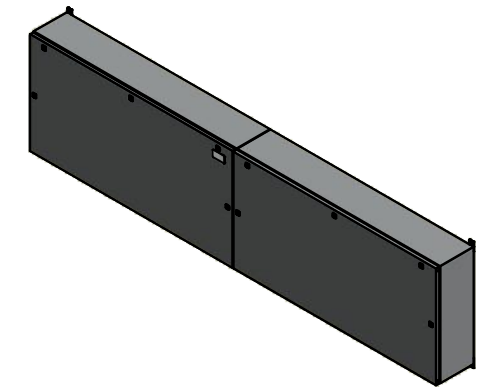

Isometric View



PACKING		
ITEM	QTY	DESCRIPTION
Cardboard sleeve	2	Top and Bottom
Cardboard strip	2	Between back of enclosure and inner panel
Plastic bag	1	To protect cover surface and inside gasket
Cardboard corner	4	To reinforced for the plastic strap tightening
Plastic strap - Black	2	To Squeeze 2 cardboard sleeve together
Packaging label	3	White label with PN
Plastic strap- Green	2	To secure the enclosure to the wood pallet
Wood Pallet	1	2" deeper and 3" larger than enclosure size

1	885 ESMF1	0	885 ESMF1 Mounting Feet Kit
1	1412BT101204DTIP2	0	1412BT 24.125" x 31" Right Inner Panel
1	1412BT101204DTBAR1-P	0	Rounded Edge Aluminum Bar 1/2" x 4"
1	1412BT101204DTBAR2-P	0	Rounded Edge Aluminum Bar 1/2" x 4"
1	1412BT101204DTBAR3-P	0	Rounded Edge Aluminum Bar 1/2" x 4"
1	1412BT101204DTBAR4-P	0	Rounded Edge Aluminum Bar 1/2" x 4"
1	1412BT101204DTIP1	0	1412BT 24.125" x 31" Left Inner Panel
16	STK-A-67400	0	Buss Bar Insulator Kit
1	STK-K-01800	5	5412 ES Accessory Kit
8	STK-Q-04050-07	7	M6 x 7mm Hexagon Socket Head Machine Screw with Nyseal
24	STK-Q-07310	2	Flange Lock Nut M8
8	STK-Q-07610	8	M8 Plastic Spacer 22.2mm
1	1412BT101204DTB	0	1412BT 30" x 120" x 10" Body
1	1412BT101204DTC	0	1412BT 30" x 120" Cover
Qty	Part Number	Rev	Description
Parts List			

	Tél: (450) 979-4373 Fax: (450) 979-4626 <a href="http://www.exmweb.com">www.exmweb.com</a>	Flatness Aplatissement Max 3.0mm
	Projection 	Customer Client
Drawn By Dessiné Par	BoxCad: BoxCad	Date 04-Oct-22
Material Matière	14 Ga Cold Rolled A1008 CS Type B (1.7mm)	
Color Couleur	Asa-61 Grey	Finish Fini Smooth
Description 1412BT 1200A - 4Wires x 120" Assembly		Detail Rev.
Part Number Numéro Pièce <b>1412BT101204DT</b>		Rev. 0 3 17

This drawing is confidential and must not be reproduced or used without the consent of EXM

Ce dessin est confidentiel et ne doit pas être reproduit ou utilisé sans le consentement de EXM

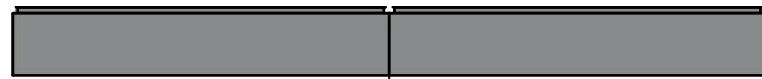

TOP



BACK

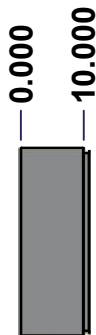

LEFT



FRONT

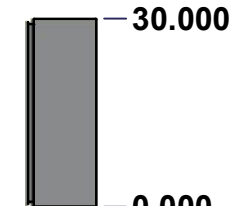

RIGHT



BOTTOM

No.	Revisions	Date	By/Par

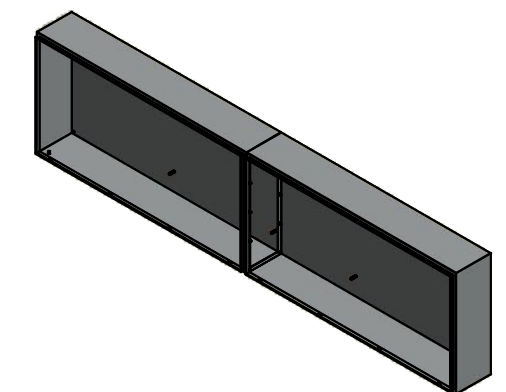

Isometric View



Tél: (450) 979-4373  
 Fax: (450) 979-4626  
[www.exmweb.com](http://www.exmweb.com)

Flatness  
Aplatissement  
Max 3.0mm  
Projection

Customer Client	Date
Drawn By Dessiné Par BoxCad: BoxCad	Date 04-Oct-22
Material Matière 14 Ga Cold Rolled A1008 CS Type B (1.7mm)	
Color Couleur Asa-61 Grey	Finish Fini Smooth
Description 1412BT 30" x 120" x 10" Body	Detail Rev.
Part Number Numéro Pièce <b>1412BT101204DTB</b>	Rev. <b>0</b>

SEE BILL OF MATERIAL ON LAST PAGE

This drawing is confidential and must not be reproduced or used without the consent of Eurobox

Ce dessin est confidentiel et ne doit pas être reproduit ou utilisé sans le consentement de Eurobox

**STANDARD FEATURES ARE NOT LISTED IN THIS HOLE TABLE**

**HOLE TABLE - BACK VIEW (CUSTOM FEATURE ONLY)**

CUT-OUT	XDIM	YDIM	DESCRIPTION
1	116.000	28.000	GND STUD M8 x 35mm (Inside)
2	116.000	26.000	GND STUD M8 x 35mm (Inside)
3	9.375	27.500	IP STUD M8 x 35mm (Inside)
4	38.625	27.500	IP STUD M8 x 35mm (Inside)
5	9.375	5.125	IP STUD M8 x 35mm (Inside)
6	38.625	5.125	IP STUD M8 x 35mm (Inside)
7	61.375	27.500	IP STUD M8 x 35mm (Inside)
8	90.625	27.500	IP STUD M8 x 35mm (Inside)
9	61.375	5.125	IP STUD M8 x 35mm (Inside)
10	90.625	5.125	IP STUD M8 x 35mm (Inside)

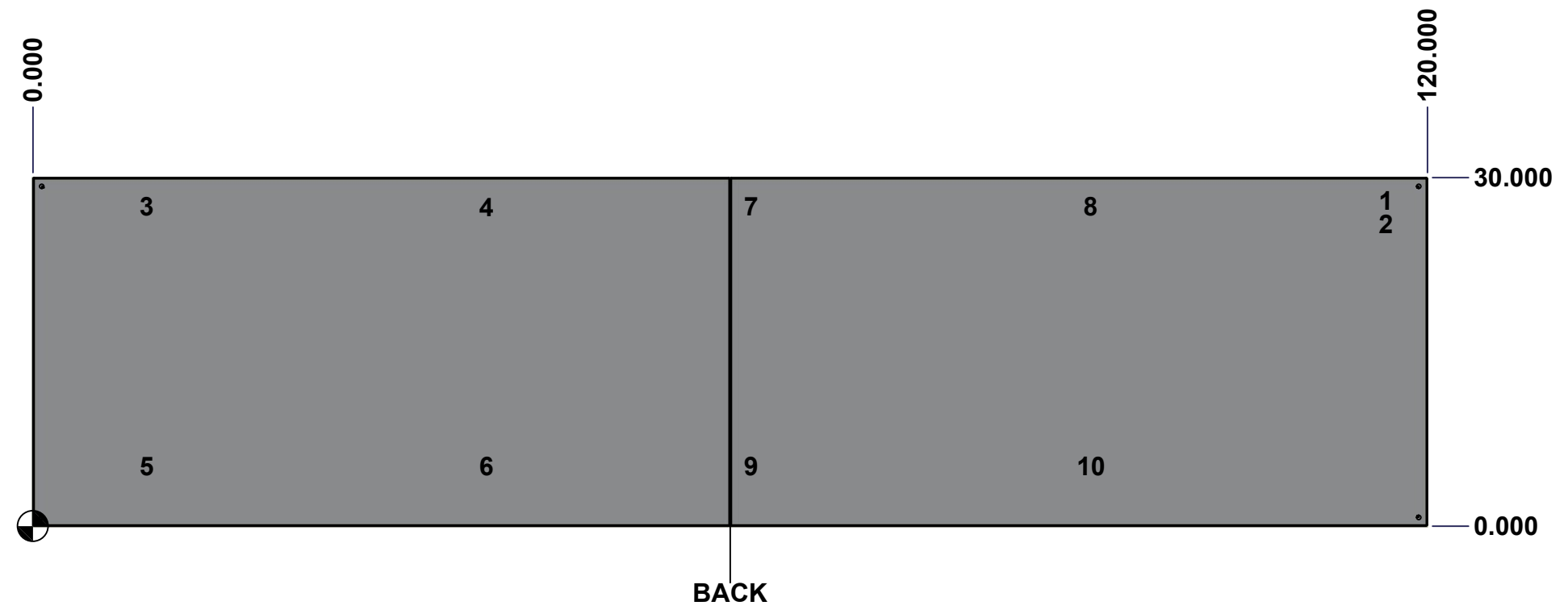

	Description	Status	
	1412BT 30" x 120" x 10" Body	(NULL)	
	Part Number Numéro Pièce	Rev.	5
	<b>1412BT101204DTB</b>	<b>0</b>	17

This drawing is confidential and must not be reproduced or used without the consent of EXM

Ce dessin est confidentiel et ne doit pas être reproduit ou utilisé sans le consentement de EXM

No.	Revisions	Date	By/Par

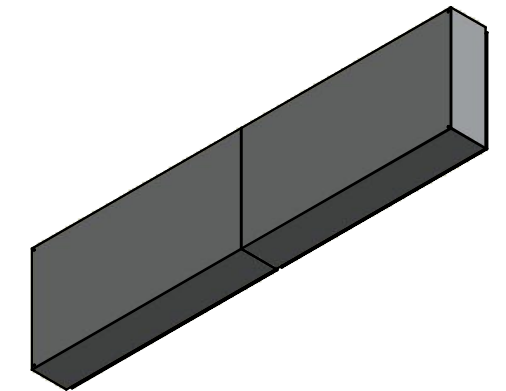

Isometric View



 Tél: (450) 979-4373 Fax: (450) 979-4626 <a href="http://www.exmweb.com">www.exmweb.com</a>	Flatness Aplatissement
	Max 3.0mm
Projection	

Customer Client	Date
Drawn By Dessiné Par	Date 04-Oct-22

Material Matière	14 Ga Cold Rolled A1008 CS Type B (1.7mm)
---------------------	---

Color Couleur	Asa-61 Grey	Finish Fini	Smooth
------------------	-------------	----------------	--------

Description	Detail Rev.
1412BT 30" x 120" x 10" Body	

Part Number Numéro Pièce	Rev.	6
<b>1412BT101204DTB</b>	<b>0</b>	17

Qty	Part Number	Rev	Description
1	STK-P-02400S	0	Powder Paint (Asa-61 Grey / Smooth)
1	1412BT101204DTB-P	0	1412BT 30" x 120" x 10" Left Body Part
1	1412BT101204DTE-P	0	1412BT 30" x 120" x 10" Right Body Part
1	STK-G-00701	0	1" x 1/4" Self-Adhesive Neoprene Gasket
10	STK-Q-00260	1	M6 x 13mm Carriage Bolt
10	STK-Q-07220	1	M6 Nylon Insert Lock Nut
10	STK-Q-16005	1	Stud M8 x 35 (No Paint Cap Required)
2	STK-Q-16080	0	Ground Stud M6 x 16mm
1	STK-S-00100	0	3.5" x 2" Silver Milar Flexcon Sticker
Parts List			

This drawing is confidential and must not be reproduced or used without the consent of Eurobox

Ce dessin est confidentiel et ne doit pas être reproduit ou utilisé sans le consentement de Eurobox

STANDARD FEATURES ARE NOT LISTED IN THIS HOLE TABLE			
HOLE TABLE - FRONT VIEW (CUSTOM FEATURE ONLY)			
CUT-OUT	XDIM	YDIM	DESCRIPTION
1	87.000	2.000	RND Ø0.201 THREAD 1/4-20 UNC
2	81.000	2.000	RND Ø0.201 THREAD 1/4-20 UNC
3	75.000	2.000	RND Ø0.201 THREAD 1/4-20 UNC
4	69.000	2.000	RND Ø0.201 THREAD 1/4-20 UNC
5	63.000	2.000	RND Ø0.201 THREAD 1/4-20 UNC
6	57.000	2.000	RND Ø0.201 THREAD 1/4-20 UNC
7	51.000	2.000	RND Ø0.201 THREAD 1/4-20 UNC
8	45.000	2.000	RND Ø0.201 THREAD 1/4-20 UNC
9	39.000	2.000	RND Ø0.201 THREAD 1/4-20 UNC
10	33.000	2.000	RND Ø0.201 THREAD 1/4-20 UNC
11	27.000	2.000	RND Ø0.201 THREAD 1/4-20 UNC
12	21.000	2.000	RND Ø0.201 THREAD 1/4-20 UNC
13	15.000	2.000	RND Ø0.201 THREAD 1/4-20 UNC
14	9.000	2.000	RND Ø0.201 THREAD 1/4-20 UNC
15	3.000	2.000	RND Ø0.201 THREAD 1/4-20 UNC

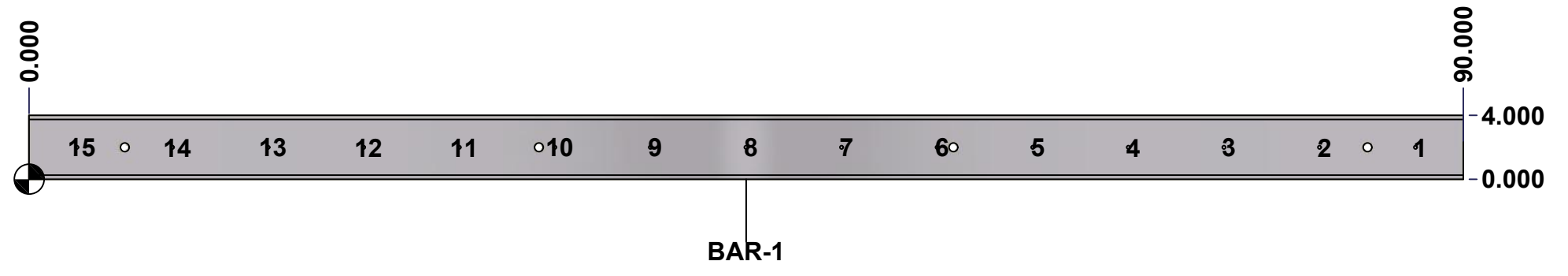

	Description	Status
	Rounded Edge Aluminum Bar 1/2" x 4"	(NULL)
	Part Number Numéro Pièce	Rev.
	<b>1412BT101204DTBAR1-P</b>	<b>0</b> / 7
		17

This drawing is confidential and must not be reproduced or used without the consent of Eurobox

Ce dessin est confidentiel et ne doit pas être reproduit ou utilisé sans le consentement de Eurobox

STANDARD FEATURES ARE NOT LISTED IN THIS HOLE TABLE			
HOLE TABLE - FRONT VIEW (CUSTOM FEATURE ONLY)			
CUT-OUT	XDIM	YDIM	DESCRIPTION
1	87.000	2.000	RND Ø0.201 THREAD 1/4-20 UNC
2	81.000	2.000	RND Ø0.201 THREAD 1/4-20 UNC
3	75.000	2.000	RND Ø0.201 THREAD 1/4-20 UNC
4	69.000	2.000	RND Ø0.201 THREAD 1/4-20 UNC
5	63.000	2.000	RND Ø0.201 THREAD 1/4-20 UNC
6	57.000	2.000	RND Ø0.201 THREAD 1/4-20 UNC
7	51.000	2.000	RND Ø0.201 THREAD 1/4-20 UNC
8	45.000	2.000	RND Ø0.201 THREAD 1/4-20 UNC
9	39.000	2.000	RND Ø0.201 THREAD 1/4-20 UNC
10	33.000	2.000	RND Ø0.201 THREAD 1/4-20 UNC
11	27.000	2.000	RND Ø0.201 THREAD 1/4-20 UNC
12	21.000	2.000	RND Ø0.201 THREAD 1/4-20 UNC
13	15.000	2.000	RND Ø0.201 THREAD 1/4-20 UNC
14	9.000	2.000	RND Ø0.201 THREAD 1/4-20 UNC
15	3.000	2.000	RND Ø0.201 THREAD 1/4-20 UNC

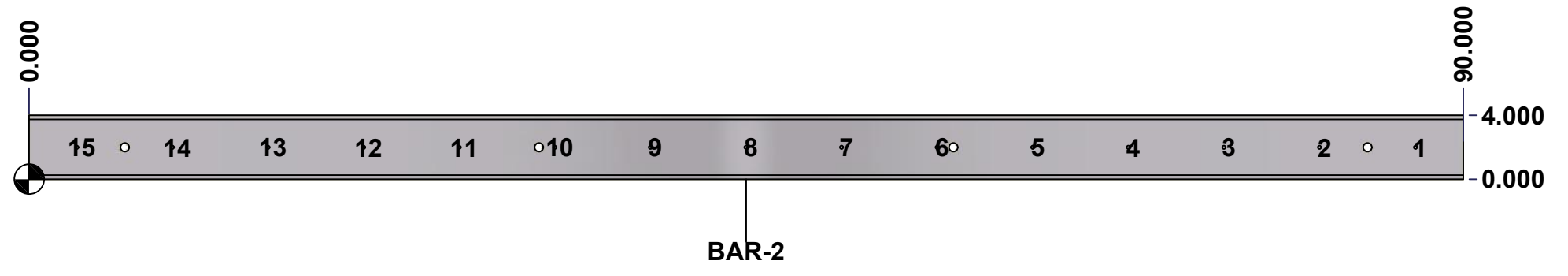

	Description	Status
	Rounded Edge Aluminum Bar 1/2" x 4"	(NULL)
	Part Number Numéro Pièce	Rev.
	<b>1412BT101204DTBAR2-P</b>	<b>0</b> / 8
		17



This drawing is confidential and must not be reproduced or used without the consent of Eurobex

Ce dessin est confidentiel et ne doit pas être reproduit ou utilisé sans le consentement de Eurobex

STANDARD FEATURES ARE NOT LISTED IN THIS HOLE TABLE			
HOLE TABLE - FRONT VIEW (CUSTOM FEATURE ONLY)			
CUT-OUT	XDIM	YDIM	DESCRIPTION
1	87.000	2.000	RND Ø0.201 THREAD 1/4-20 UNC
2	81.000	2.000	RND Ø0.201 THREAD 1/4-20 UNC
3	75.000	2.000	RND Ø0.201 THREAD 1/4-20 UNC
4	69.000	2.000	RND Ø0.201 THREAD 1/4-20 UNC
5	63.000	2.000	RND Ø0.201 THREAD 1/4-20 UNC
6	57.000	2.000	RND Ø0.201 THREAD 1/4-20 UNC
7	51.000	2.000	RND Ø0.201 THREAD 1/4-20 UNC
8	45.000	2.000	RND Ø0.201 THREAD 1/4-20 UNC
9	39.000	2.000	RND Ø0.201 THREAD 1/4-20 UNC
10	33.000	2.000	RND Ø0.201 THREAD 1/4-20 UNC
11	27.000	2.000	RND Ø0.201 THREAD 1/4-20 UNC
12	21.000	2.000	RND Ø0.201 THREAD 1/4-20 UNC
13	15.000	2.000	RND Ø0.201 THREAD 1/4-20 UNC
14	9.000	2.000	RND Ø0.201 THREAD 1/4-20 UNC
15	3.000	2.000	RND Ø0.201 THREAD 1/4-20 UNC

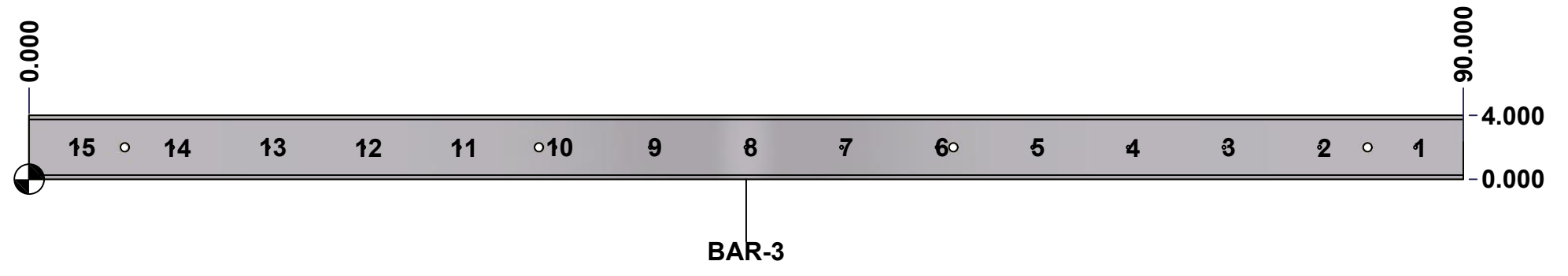

	Description	Status
	Rounded Edge Aluminum Bar 1/2" x 4"	(NULL)
	Part Number Numéro Pièce	Rev.
	<b>1412BT101204DTBAR3-P</b>	<b>0</b>
		9
		17

This drawing is confidential and must not be reproduced or used without the consent of Eurobox

Ce dessin est confidentiel et ne doit pas être reproduit ou utilisé sans le consentement de Eurobox

STANDARD FEATURES ARE NOT LISTED IN THIS HOLE TABLE			
HOLE TABLE - FRONT VIEW (CUSTOM FEATURE ONLY)			
CUT-OUT	XDIM	YDIM	DESCRIPTION
1	87.000	2.000	RND Ø0.201 THREAD 1/4-20 UNC
2	81.000	2.000	RND Ø0.201 THREAD 1/4-20 UNC
3	75.000	2.000	RND Ø0.201 THREAD 1/4-20 UNC
4	69.000	2.000	RND Ø0.201 THREAD 1/4-20 UNC
5	63.000	2.000	RND Ø0.201 THREAD 1/4-20 UNC
6	57.000	2.000	RND Ø0.201 THREAD 1/4-20 UNC
7	51.000	2.000	RND Ø0.201 THREAD 1/4-20 UNC
8	45.000	2.000	RND Ø0.201 THREAD 1/4-20 UNC
9	39.000	2.000	RND Ø0.201 THREAD 1/4-20 UNC
10	33.000	2.000	RND Ø0.201 THREAD 1/4-20 UNC
11	27.000	2.000	RND Ø0.201 THREAD 1/4-20 UNC
12	21.000	2.000	RND Ø0.201 THREAD 1/4-20 UNC
13	15.000	2.000	RND Ø0.201 THREAD 1/4-20 UNC
14	9.000	2.000	RND Ø0.201 THREAD 1/4-20 UNC
15	3.000	2.000	RND Ø0.201 THREAD 1/4-20 UNC

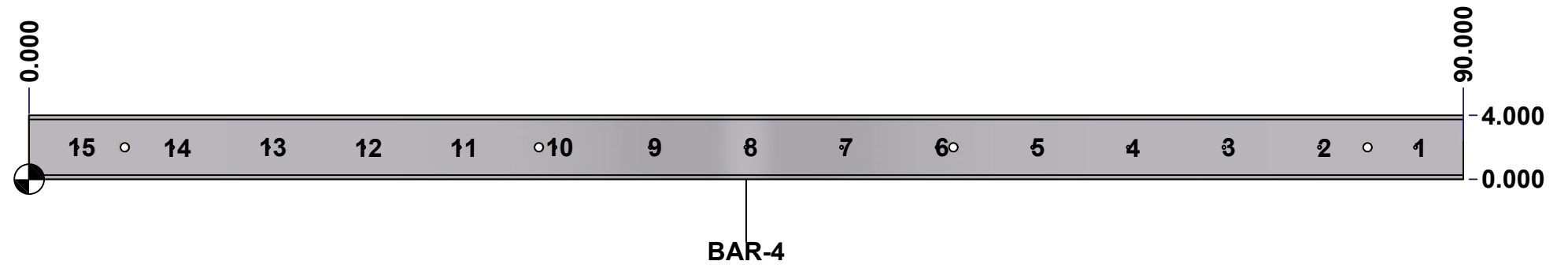

	Description	Status	
	Rounded Edge Aluminum Bar 1/2" x 4"	(NULL)	
	Part Number Numéro Pièce	Rev.	10
	<b>1412BT101204DTBAR4-P</b>	<b>0</b>	17

This drawing is confidential and must not be reproduced or used without the consent of EXM

Ce dessin est confidentiel et ne doit pas être reproduit ou utilisé sans le consentement de EXM

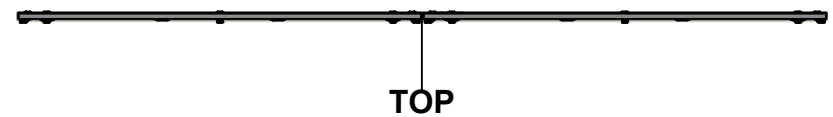

TOP

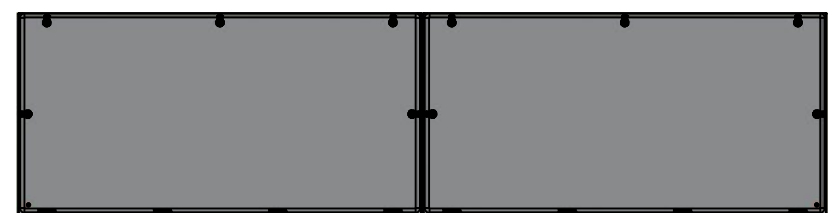

BACK

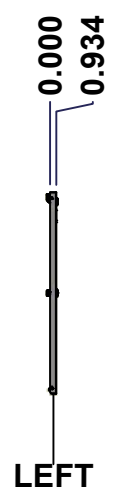

LEFT

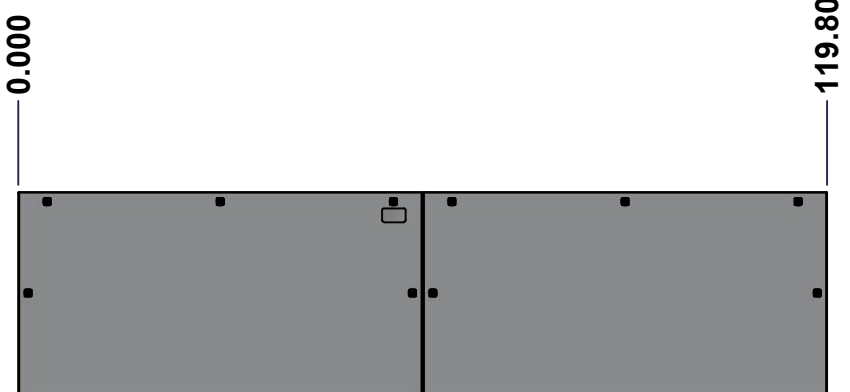

FRONT

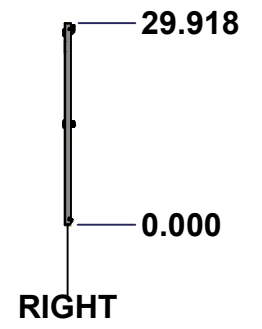

RIGHT



BOTTOM

No.	Revisions	Date	By/Par

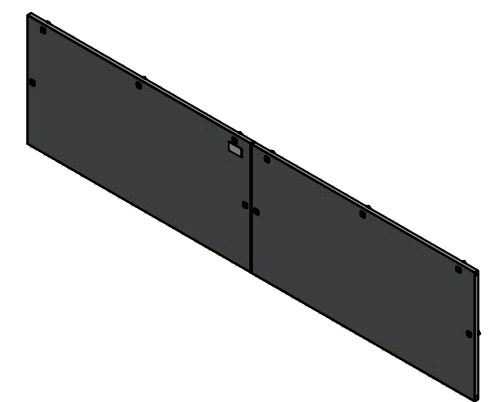

Isometric View



Tél: (450) 979-4373  
 Fax: (450) 979-4626  
[www.exmweb.com](http://www.exmweb.com)

Flatness  
Aplatissement  
Max 3.0mm  
Projection

Customer Client	Date
Drawn By / Dessiné Par: BoxCad: BoxCad	Date: 04-Oct-22
Material / Matière: 14 Ga Cold Rolled A1008 CS Type B (1.7mm)	

Color / Couleur: Asa-61 Grey	Finish / Fini: Smooth
------------------------------	-----------------------

Description: 1412BT 30" x 120" Cover	Detail Rev.
--------------------------------------	-------------

Part Number / Numéro Pièce: 1412BT101204DTC	Rev. 0	11 / 17
---	--------	---------

SEE BILL OF MATERIAL ON LAST PAGE

This drawing is confidential and must not be reproduced or used without the consent of Eurobox

Ce dessin est confidentiel et ne doit pas être reproduit ou utilisé sans le consentement de Eurobox

**STANDARD FEATURES ARE NOT LISTED IN THIS HOLE TABLE**

**HOLE TABLE - FRONT VIEW (CUSTOM FEATURE ONLY)**

CUT-OUT	XDIM	YDIM	DESCRIPTION
1	1.500	1.486	GND STUD M6 x 16mm (Inside)
2	118.303	1.486	GND STUD M6 x 16mm (Inside)
3	118.379	14.959	LOCK 880 SCQ4-SL @ 0.0°
4	61.424	14.959	LOCK 880 SCQ4-SL @ 180.0°
5	58.379	14.959	LOCK 880 SCQ4-SL @ 0.0°
6	1.424	14.959	LOCK 880 SCQ4-SL @ 180.0°
7	115.553	28.494	LOCK 880 SCQ4-SL @ 90.0°
8	89.902	28.494	LOCK 880 SCQ4-SL @ 90.0°
9	64.250	28.494	LOCK 880 SCQ4-SL @ 90.0°
10	55.553	28.494	LOCK 880 SCQ4-SL @ 90.0°
11	29.902	28.494	LOCK 880 SCQ4-SL @ 90.0°
12	4.250	28.494	LOCK 880 SCQ4-SL @ 90.0°

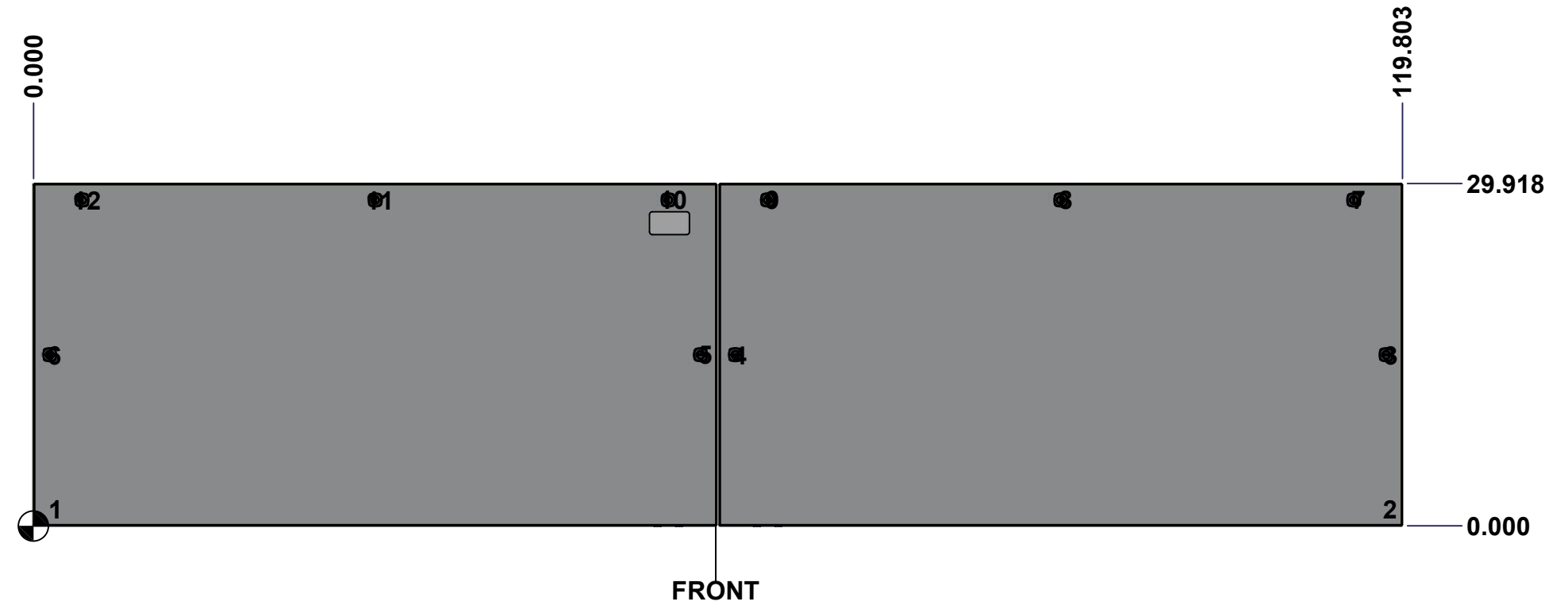

	Description 1412BT 30" x 120" Cover	Status (NULL)
	Part Number Numéro Pièce <b>1412BT101204DTC</b>	Rev. 12 <b>0</b> 17

This drawing is confidential and must not be reproduced or used without the consent of EXM

Ce dessin est confidentiel et ne doit pas être reproduit ou utilisé sans le consentement de EXM

No.	Revisions	Date	By/Par

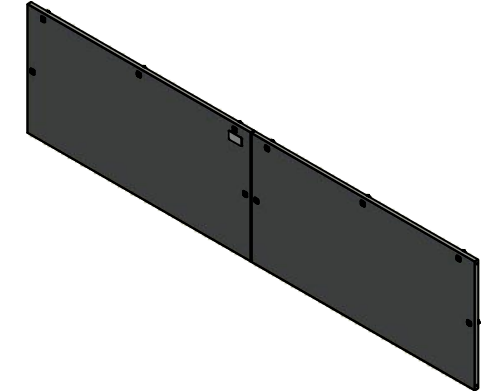

Isometric View



Tél: (450) 979-4373  
 Fax: (450) 979-4626  
[www.exmweb.com](http://www.exmweb.com)

Flatness  
Aplatissement  
Max 3.0mm  
Projection

Customer Client	Date
Drawn By / Dessiné Par: BoxCad: BoxCad	Date: 04-Oct-22

Material / Matière: 14 Ga Cold Rolled A1008 CS Type B (1.7mm)

Color / Couleur: Asa-61 Grey	Finish / Fini: Smooth
------------------------------	-----------------------

Description: 1412BT 30" x 120" Cover	Detail Rev.
--------------------------------------	-------------

Part Number / Numéro Pièce: <b>1412BT101204DTC</b>	Rev. 0	13 / 17
--	--------	---------

Qty	Part Name	Rev	Description
2	1412BT101204DTG	0	1412BT 30" x 120" Cover Gasket
1	STK-P-02400S	0	Powder Paint (Asa-61 Grey / Smooth)
8	STK-K-09800	10	5412 ES Hinge with 2 Captive Hinge Pins
2	STK-Q-16080	0	Ground Stud M6 x 16mm
1	STK-S-00100	0	3.5" x 2" Silver Milar Flexcon Sticker
1	1412BT101204DTC-P	0	1412BT 30" x 60" Left Cover Part
1	1412BT101204DTF-P	0	1412BT 30" x 120" Right Cover Part
10	880 SCQ4-SL	6	5412 ES 1/4 Turn Lock
Parts List			

This drawing is confidential and must not be reproduced or used without the consent of EXM

Ce dessin est confidentiel et ne doit pas être reproduit ou utilisé sans le consentement de EXM

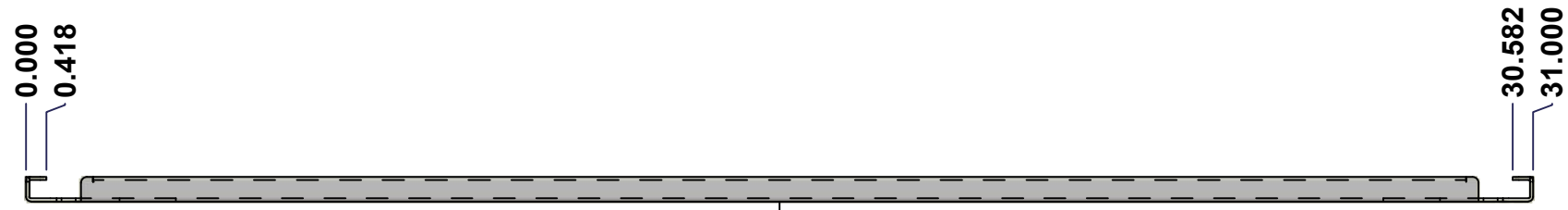

TOP



FRONT

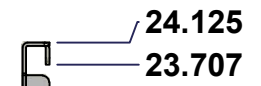

RIGHT

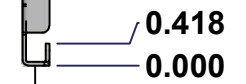

No.	Revisions	Date	By/Par

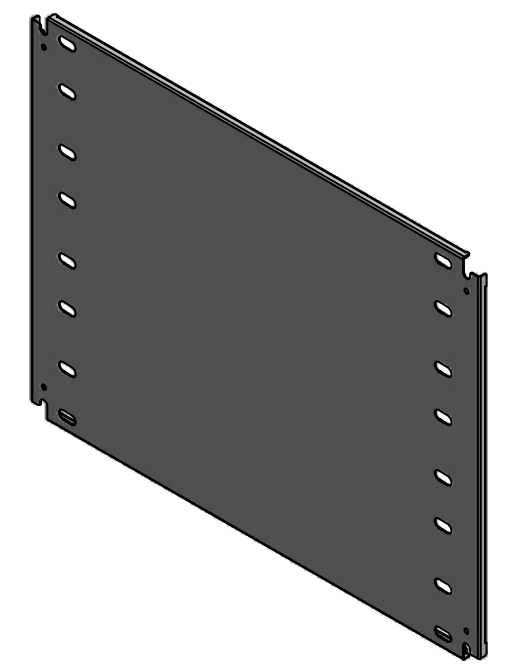

Isometric View



Tél: (450) 979-4373  
 Fax: (450) 979-4626  
[www.exmweb.com](http://www.exmweb.com)

Flatness  
Aplatissement  
Max 3.0mm  
Projection

Customer Client	Date
Drawn By / Dessiné Par: BoxCad: BoxCad	Date: 04-Oct-22
Material / Matière: 14 Ga Cold Rolled A1008 CS Type B (1.7mm)	

Color / Couleur: White RAL9003	Finish / Fini: Smooth
--------------------------------	-----------------------

Description: 1412BT 24.125" x 31" Left Inner Panel	Detail Rev.
--	-------------

Part Number / Numéro Pièce: 1412BT101204DTIP1	Rev. 0	14 / 17
---	--------	---------

SEE BILL OF MATERIAL ON LAST PAGE

This drawing is confidential and must not be reproduced or used without the consent of EXM

Ce dessin est confidentiel et ne doit pas être reproduit ou utilisé sans le consentement de EXM

No.	Revisions	Date	By/Par

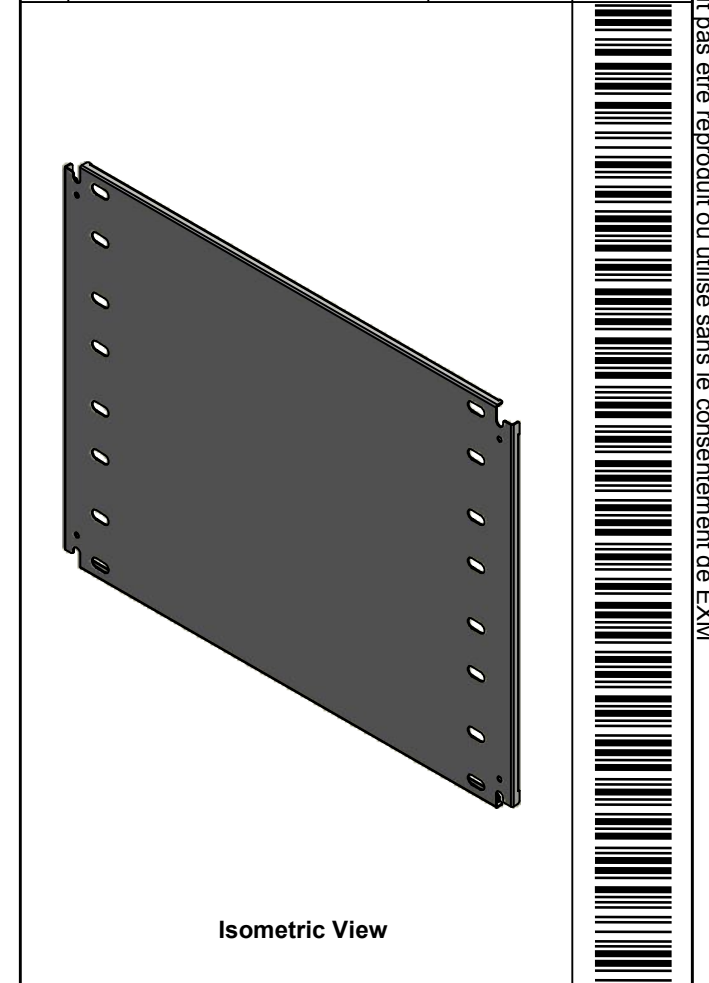

Isometric View



 Tél: (450) 979-4373 Fax: (450) 979-4626 <a href="http://www.exmweb.com">www.exmweb.com</a>		Flatness Aplatissement Max 3.0mm
Customer Client		Date
Drawn By / Dessiné Par: BoxCad: BoxCad		Date: 04-Oct-22
Material / Matière: 14 Ga Cold Rolled A1008 CS Type B (1.7mm)		
Color / Couleur: White RAL9003		Finish / Fini: Smooth
Description: 1412BT 24.125" x 31" Left Inner Panel		Detail Rev.
Part Number / Numéro Pièce: <b>1412BT101204DTIP1</b>		Rev. 0 / 15

Qty	Part Number	Rev	Description
1	STK-P-02401S	0	Powder Paint (White / Smooth)
1	1412BT101204DTIP1-P	0	1412BT 24.125" x 120" Left Inner Panel Part
Parts List			

This drawing is confidential and must not be reproduced or used without the consent of EXM

Ce dessin est confidentiel et ne doit pas être reproduit ou utilisé sans le consentement de EXM

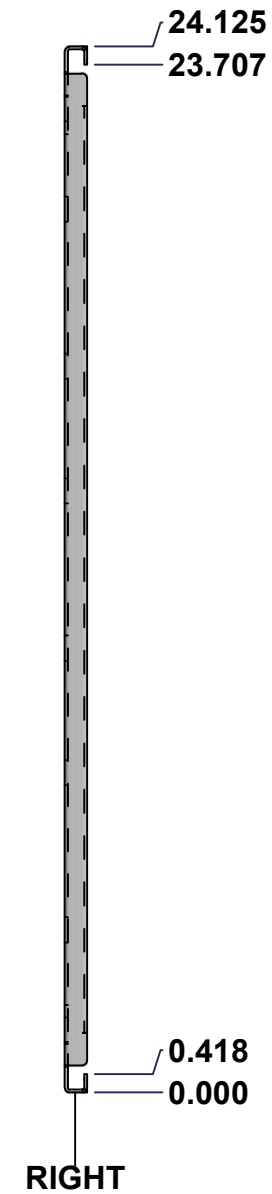
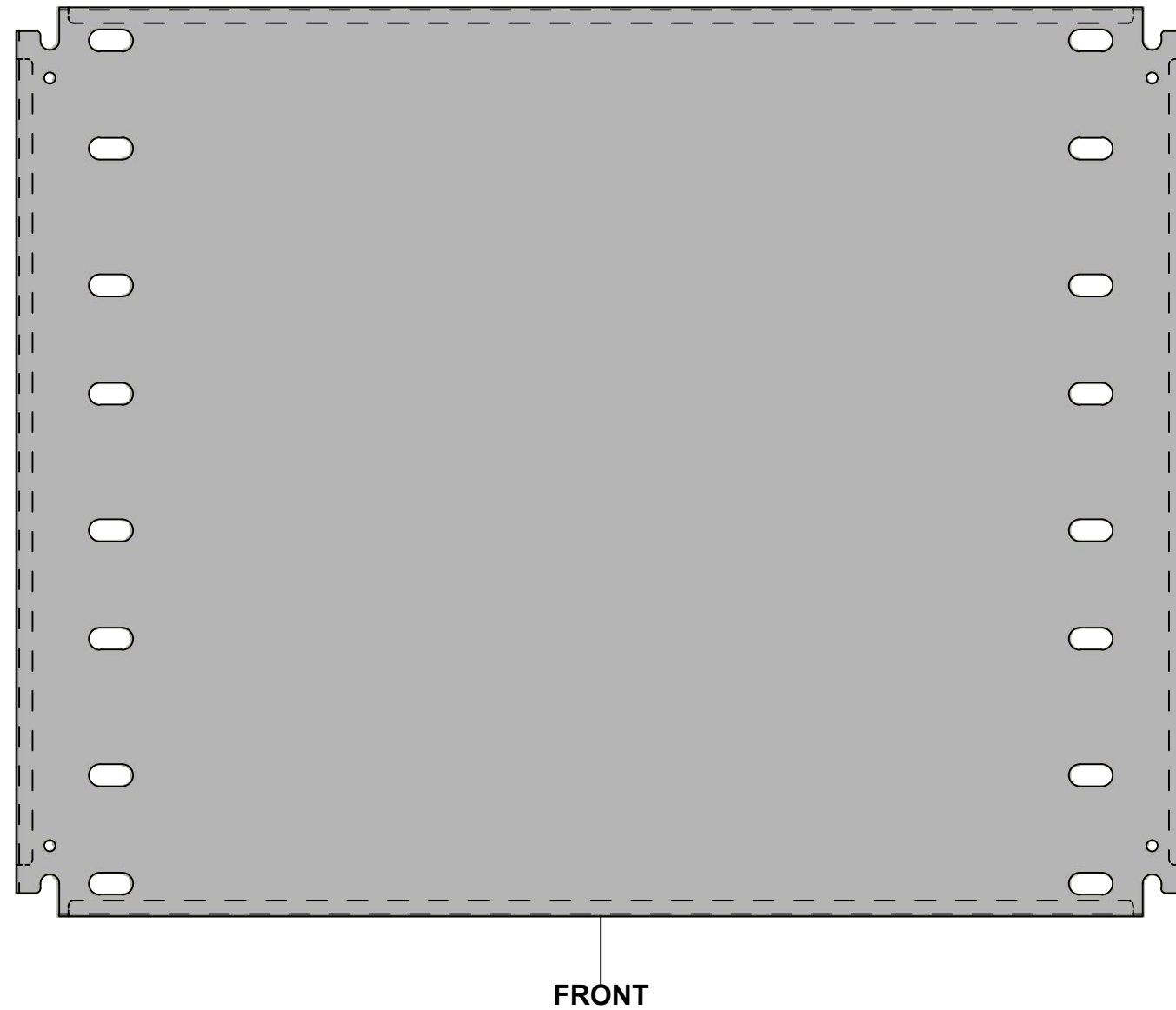
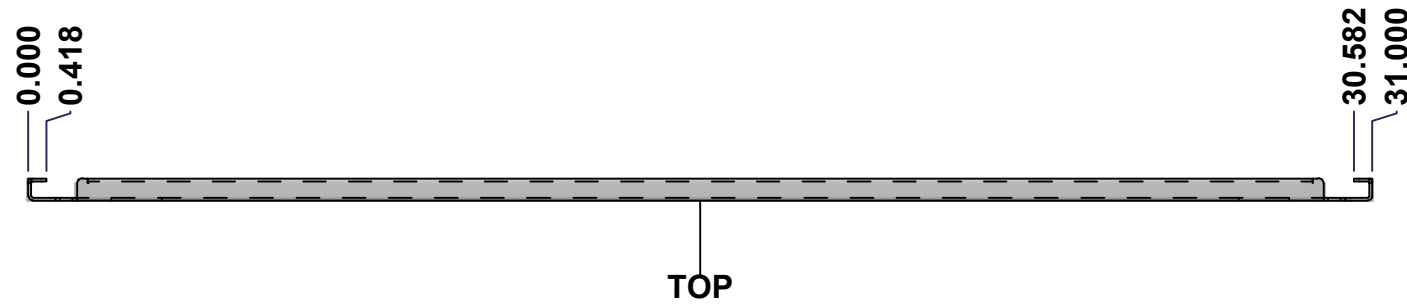

No.	Revisions	Date	By/Par

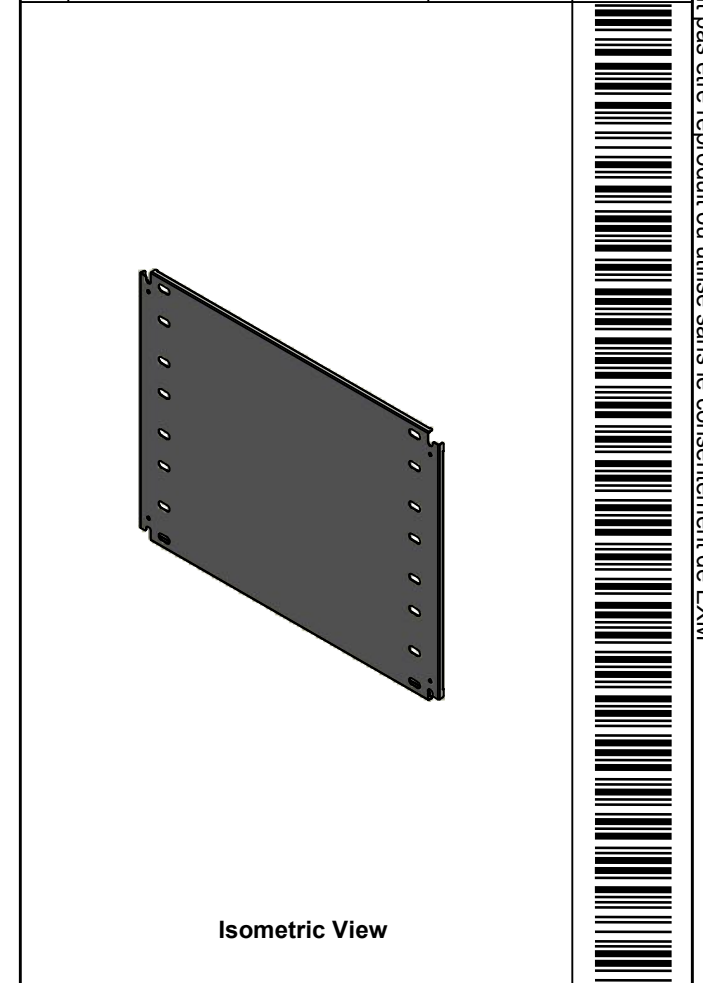

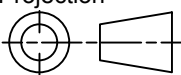
 Tél: (450) 979-4373 Fax: (450) 979-4626 <a href="http://www.exmweb.com">www.exmweb.com</a>		Flatness Aplatissement Max 3.0mm Projection 
Customer Client	Date	Date
Drawn By Dessiné Par	BoxCad: BoxCad	04-Oct-22
Material Matière	14 Ga Cold Rolled A1008 CS Type B (1.7mm)	
Color Couleur	White RAL9003	Finish Fini Smooth
Description 1412BT 24.125" x 31" Right Inner Panel		Detail Rev.
Part Number Numéro Pièce	Rev. 0	16 17

SEE BILL OF MATERIAL ON LAST PAGE

**1412BT101204DTIP2**



This drawing is confidential and must not be reproduced or used without the consent of EXM

Ce dessin est confidentiel et ne doit pas être reproduit ou utilisé sans le consentement de EXM

No.	Revisions	Date	By/Par

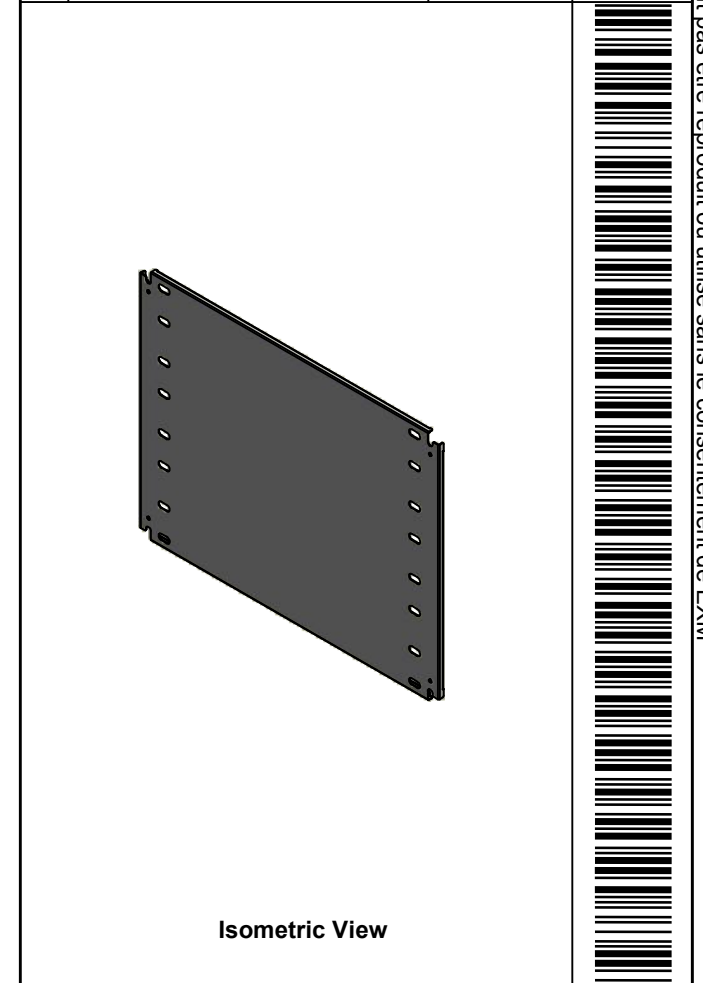

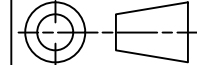
 Tél: (450) 979-4373 Fax: (450) 979-4626 <a href="http://www.exmweb.com">www.exmweb.com</a>		Flatness Aplatissement Max 3.0mm
Customer Client		Projection 
Drawn By / Dessiné Par: BoxCad: BoxCad		Date: 04-Oct-22
Material / Matière: 14 Ga Cold Rolled A1008 CS Type B (1.7mm)		
Color / Couleur: White RAL9003	Finish / Fini: Smooth	
Description: 1412BT 24.125" x 31" Right Inner Panel		Detail Rev.
Part Number / Numéro Pièce: <b>1412BT101204DTIP2</b>		Rev. 17 <b>0</b>

Qty	Part Number	Rev	Description
1	STK-P-02401S	0	Powder Paint (White / Smooth)
1	1412BT101204DTIP2-P	0	1412BT 24.125" x 120" Right Inner Panel Part
Parts List			