

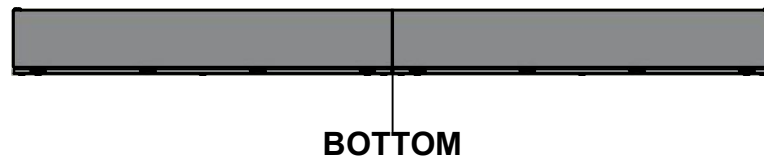

This drawing is confidential and must not be reproduced or used without the consent of EXM

Ce dessin est confidentiel et ne doit pas être reproduit ou utilisé sans le consentement de EXM

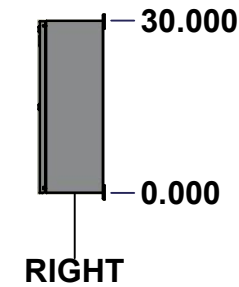
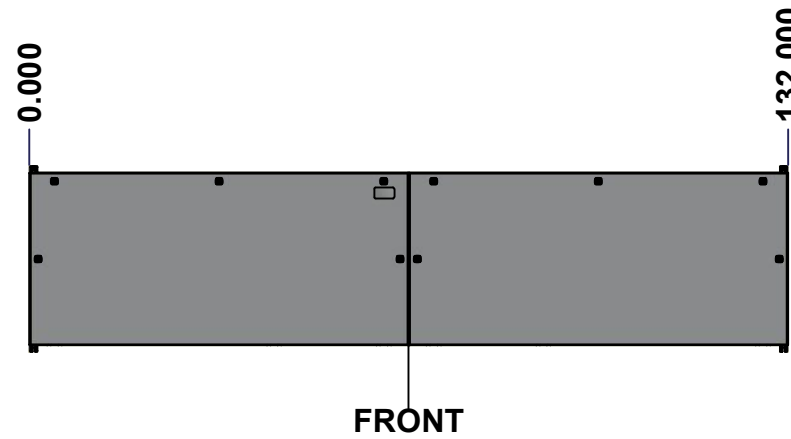
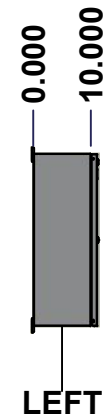
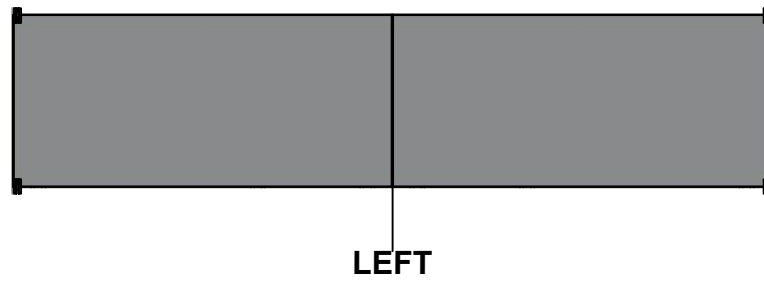
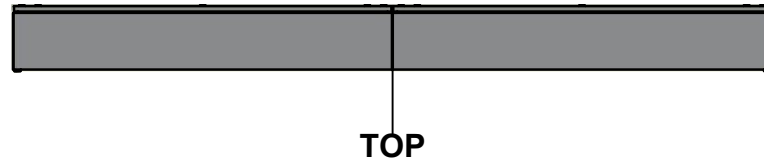
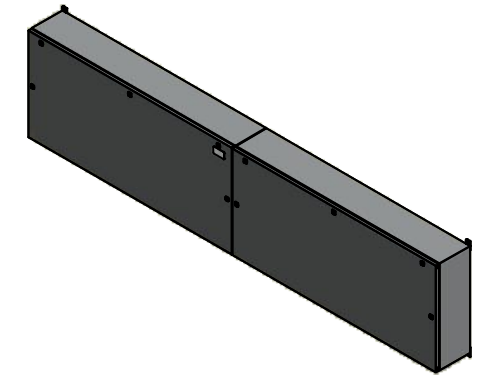

No.	Revisions	Date	By/Par



 Tél: (450) 979-4373 Fax: (450) 979-4626 www.exmweb.com		Flatness Aplatissement	
		Max 3.0mm	
Customer Client		Date	
Drawn By Dessiné Par BoxCad: BoxCad		Date 2022-10-03	
Material Matière 14 Ga Cold Rolled A1008 CS Type B (1.7mm)			
Color Couleur Asa-61 Grey		Finish Fini Smooth	
Description 1412BT 600A - 4Wires x 132" Assembly			Detail Rev.
Part Number Numéro Pièce 1412BT11604DT		Rev. 0	1 / 17

SEE BILL OF MATERIAL ON LAST PAGE

This drawing is confidential and must not be reproduced or used without the consent of Eurobox

Ce dessin est confidentiel et ne doit pas être reproduit ou utilisé sans le consentement de Eurobox

STANDARD FEATURES ARE NOT LISTED IN THIS HOLE TABLE

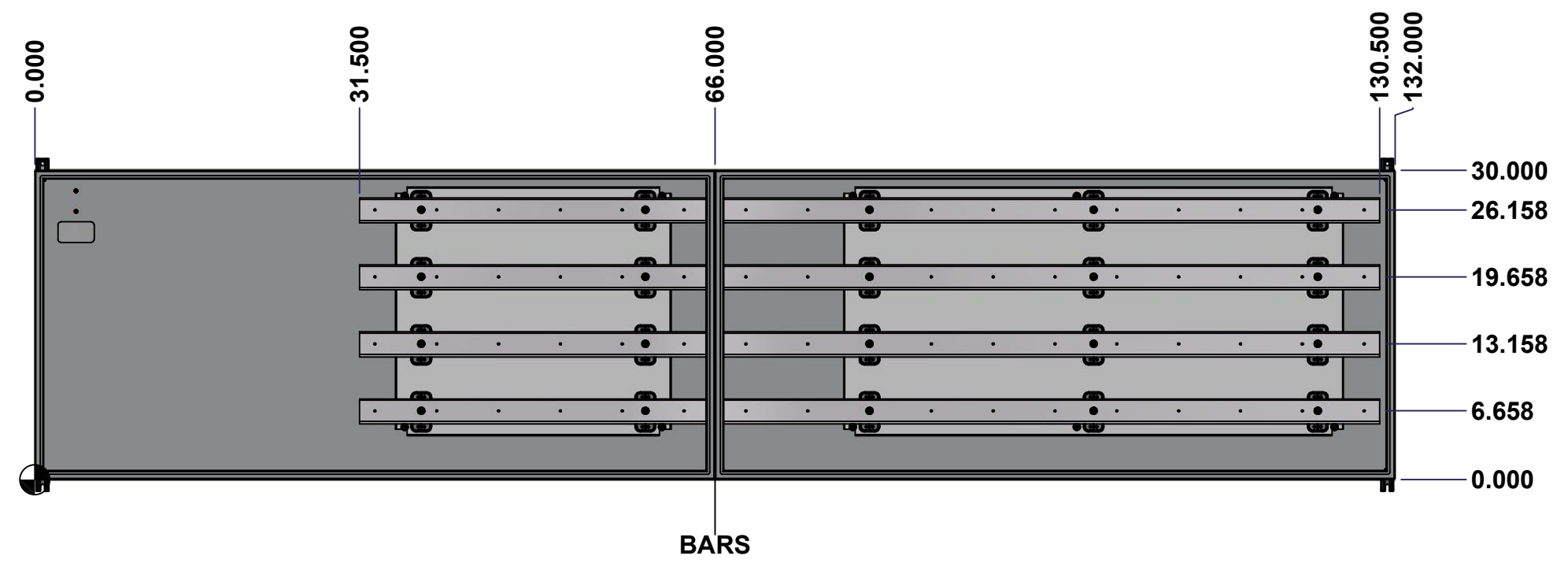

	Description 1412BT 600A - 4Wires x 132" Assembly	Status (NULL)
	Part Number Numéro Pièce 1412BT11604DT	Rev. 2 0

This drawing is confidential and must not be reproduced or used without the consent of EXM

Ce dessin est confidentiel et ne doit pas être reproduit ou utilisé sans le consentement de EXM

NOTE	
ITEM	DESCRIPTION
1	NEMA 4/12 Enclosure
2	C/W Standard ground studs on box and cover
3	W/O Standard door stiffener
4	C/W Special inner panel (Sold separately)
5	C/W Standard inner panel mounting studs

No.	Revisions	Date	By/Par

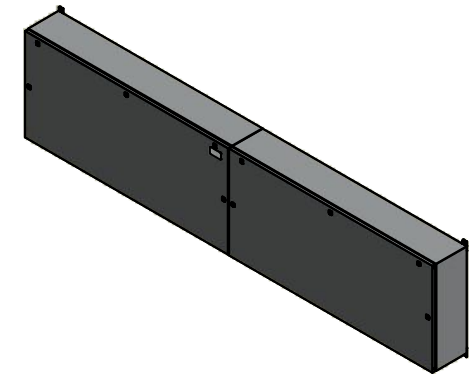

Isometric View

PACKING		
ITEM	QTY	DESCRIPTION
Cardboard sleeve	2	Top and Bottom
Cardboard strip	2	Between back of enclosure and inner panel
Plastic bag	1	To protect cover surface and inside gasket
Cardboard corner	4	To reinforced for the plastic strap tightening
Plastic strap - Black	2	To Squeeze 2 cardboard sleeve together
Packaging label	3	White label with PN
Plastic strap- Green	2	To secure the enclosure to the wood pallet
Wood Pallet	1	2" deeper and 3" larger than enclosure size

1	885 ESMF1	0	885 ESMF1 Mounting Feet Kit
1	1412BT11604DTIP2	0	1412BT 24.125" x 48.5" Right Inner Panel
1	1412BT11604DTBAR1-P	0	Rounded Edge Aluminum Bar 3/8" x 2 1/2"
1	1412BT11604DTBAR2-P	0	Rounded Edge Aluminum Bar 3/8" x 2 1/2"
1	1412BT11604DTBAR3-P	0	Rounded Edge Aluminum Bar 3/8" x 2 1/2"
1	1412BT11604DTBAR4-P	0	Rounded Edge Aluminum Bar 3/8" x 2 1/2"
1	1412BT11604DTIP1	0	1412BT 24.125" x 26.75" Left Inner Panel
20	STK-A-67400	0	Buss Bar Insulator Kit
1	STK-K-01800	5	5412 ES Accessory Kit
8	STK-Q-04050-07	7	M6 x 7mm Hexagon Socket Head Machine Screw with Nyseal
30	STK-Q-07310	2	Flange Lock Nut M8
10	STK-Q-07610	8	M8 Plastic Spacer 22.2mm
1	1412BT11604DTB	0	1412BT 30" x 132" x 10" Body
1	1412BT11604DTC	0	1412BT 30" x 132" Cover
Qty	Part Number	Rev	Description
Parts List			



Tél: (450) 979-4373
Fax: (450) 979-4626
www.exmweb.com

Flatness
Aplatissement
Max 3.0mm

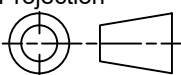
Projection

Customer Client		Date
Drawn By Dessiné Par BoxCad: BoxCad		Date 2022-10-03
Material Matière 14 Ga Cold Rolled A1008 CS Type B (1.7mm)		
Color Couleur	Asa-61 Grey	Finish Fini Smooth
Description 1412BT 600A - 4Wires x 132" Assembly		Detail Rev.
Part Number Numéro Pièce 1412BT11604DT		Rev. 0

This drawing is confidential and must not be reproduced or used without the consent of EXM

Ce dessin est confidentiel et ne doit pas être reproduit ou utilisé sans le consentement de EXM

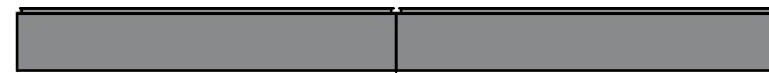

TOP



BACK

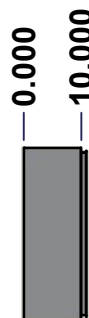

LEFT

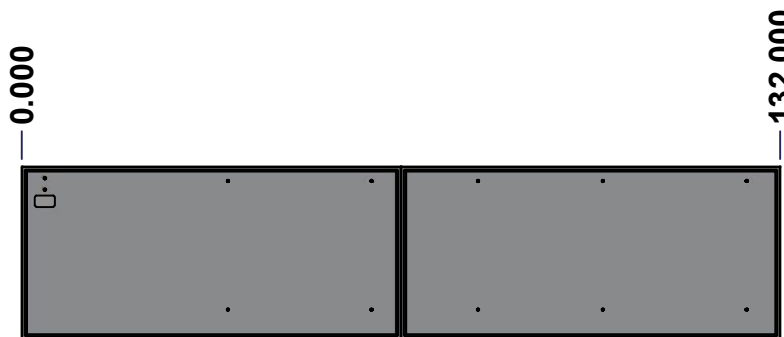

FRONT

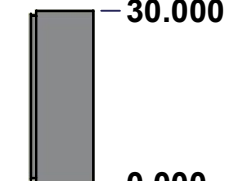

RIGHT



BOTTOM

No.	Revisions	Date	By/Par

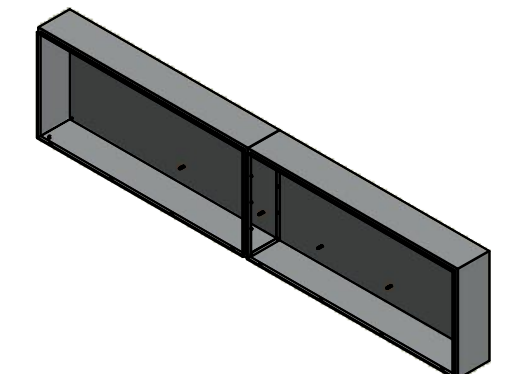

Isometric View



Tél: (450) 979-4373
 Fax: (450) 979-4626
www.exmweb.com

Flatness
Aplatissement

Max 3.0mm

Projection

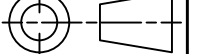

Customer Client	Date
Drawn By Dessiné Par BoxCad: BoxCad	Date 2022-10-03
Material Matière 14 Ga Cold Rolled A1008 CS Type B (1.7mm)	
Color Couleur Asa-61 Grey	Finish Fini Smooth
Description 1412BT 30" x 132" x 10" Body	Detail Rev.
Part Number Numéro Pièce 1412BT11604DTB	Rev. 0

SEE BILL OF MATERIAL ON LAST PAGE

This drawing is confidential and must not be reproduced or used without the consent of Eurobox

Ce dessin est confidentiel et ne doit pas être reproduit ou utilisé sans le consentement de Eurobox

STANDARD FEATURES ARE NOT LISTED IN THIS HOLE TABLE

HOLE TABLE - BACK VIEW (CUSTOM FEATURE ONLY)

CUT-OUT	XDIM	YDIM	DESCRIPTION
1	128.000	28.000	GND STUD M8 x 35mm (Inside)
2	128.000	26.000	GND STUD M8 x 35mm (Inside)
3	5.875	27.500	IP STUD M8 x 35mm (Inside)
4	52.625	27.500	IP STUD M8 x 35mm (Inside)
5	5.875	5.125	IP STUD M8 x 35mm (Inside)
6	52.625	5.125	IP STUD M8 x 35mm (Inside)
7	71.125	27.500	IP STUD M8 x 35mm (Inside)
8	96.125	27.500	IP STUD M8 x 35mm (Inside)
9	71.125	5.125	IP STUD M8 x 35mm (Inside)
10	96.125	5.125	IP STUD M8 x 35mm (Inside)
11	30.875	27.500	IP STUD M8 x 35mm (Inside)
12	30.875	5.125	IP STUD M8 x 35mm (Inside)

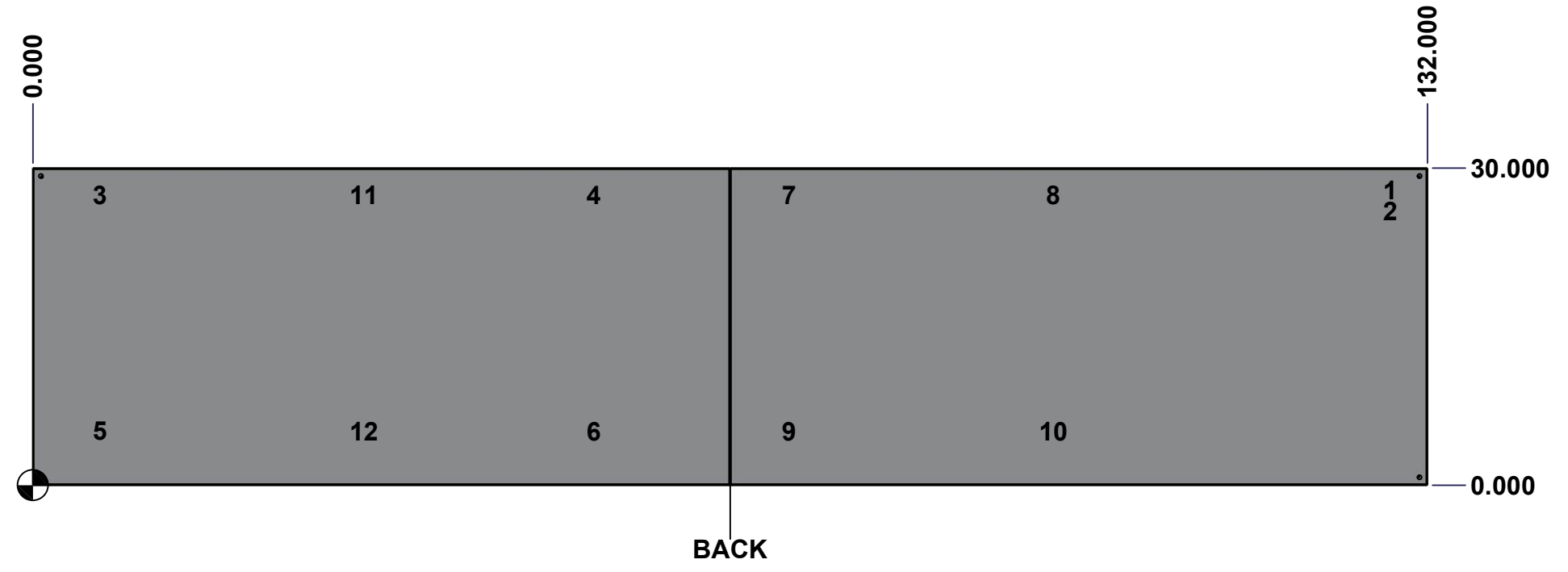

	Description 1412BT 30" x 132" x 10" Body	Status (NULL)
	Part Number Numéro Pièce 1412BT11604DTB	Rev. 5 0

This drawing is confidential and must not be reproduced or used without the consent of EXM

Ce dessin est confidentiel et ne doit pas être reproduit ou utilisé sans le consentement de EXM

No.	Revisions	Date	By/Par

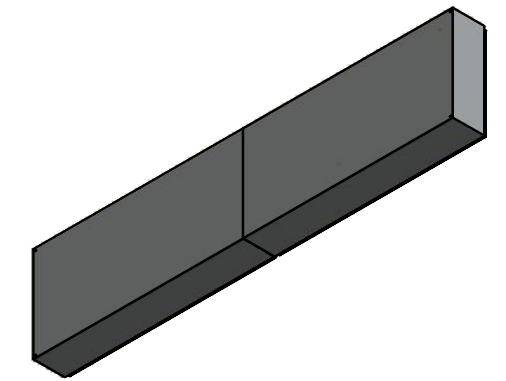

Isometric View



 Tél: (450) 979-4373 Fax: (450) 979-4626 www.exmweb.com	Flatness Aplatissement
	Max 3.0mm
Projection	

Customer Client	Date
Drawn By Dessiné Par	Date 2022-10-03

Material Matière	14 Ga Cold Rolled A1008 CS Type B (1.7mm)
---------------------	---

Color Couleur	Asa-61 Grey	Finish Fini	Smooth
------------------	-------------	----------------	--------

Description	Detail Rev.
1412BT 30" x 132" x 10" Body	

Part Number Numéro Pièce	Rev.	6
1412BT11604DTB	0	17

Qty	Part Number	Rev	Description
1	STK-P-02400S	0	Powder Paint (Asa-61 Grey / Smooth)
1	1412BT11604DTB-P	0	1412BT 30" x 132" x 10" Left Body Part
1	1412BT11604DTE-P	0	1412BT 30" x 132" x 10" Right Body Part
1	STK-G-00701	0	1" x 1/4" Self-Adhesive Neoprene Gasket
10	STK-Q-00260	1	M6 x 13mm Carriage Bolt
10	STK-Q-07220	1	M6 Nylon Insert Lock Nut
12	STK-Q-16005	1	Stud M8 x 35 (No Paint Cap Required)
2	STK-Q-16080	0	Ground Stud M6 x 16mm
1	STK-S-00100	0	3.5" x 2" Silver Milar Flexcon Sticker
Parts List			

This drawing is confidential and must not be reproduced or used without the consent of Eurobox

Ce dessin est confidentiel et ne doit pas être reproduit ou utilisé sans le consentement de Eurobox

STANDARD FEATURES ARE NOT LISTED IN THIS HOLE TABLE			
HOLE TABLE - FRONT VIEW (CUSTOM FEATURE ONLY)			
CUT-OUT	XDIM	YDIM	DESCRIPTION
1	97.500	1.250	RND Ø0.201 THREAD 1/4-20 UNC
2	91.500	1.250	RND Ø0.201 THREAD 1/4-20 UNC
3	85.500	1.250	RND Ø0.201 THREAD 1/4-20 UNC
4	79.500	1.250	RND Ø0.201 THREAD 1/4-20 UNC
5	73.500	1.250	RND Ø0.201 THREAD 1/4-20 UNC
6	67.500	1.250	RND Ø0.201 THREAD 1/4-20 UNC
7	61.500	1.250	RND Ø0.201 THREAD 1/4-20 UNC
8	55.500	1.250	RND Ø0.201 THREAD 1/4-20 UNC
9	43.500	1.250	RND Ø0.201 THREAD 1/4-20 UNC
10	37.500	1.250	RND Ø0.201 THREAD 1/4-20 UNC
11	31.500	1.250	RND Ø0.201 THREAD 1/4-20 UNC
12	25.500	1.250	RND Ø0.201 THREAD 1/4-20 UNC
13	19.500	1.250	RND Ø0.201 THREAD 1/4-20 UNC
14	13.500	1.250	RND Ø0.201 THREAD 1/4-20 UNC
15	7.500	1.250	RND Ø0.201 THREAD 1/4-20 UNC
16	1.500	1.250	RND Ø0.201 THREAD 1/4-20 UNC

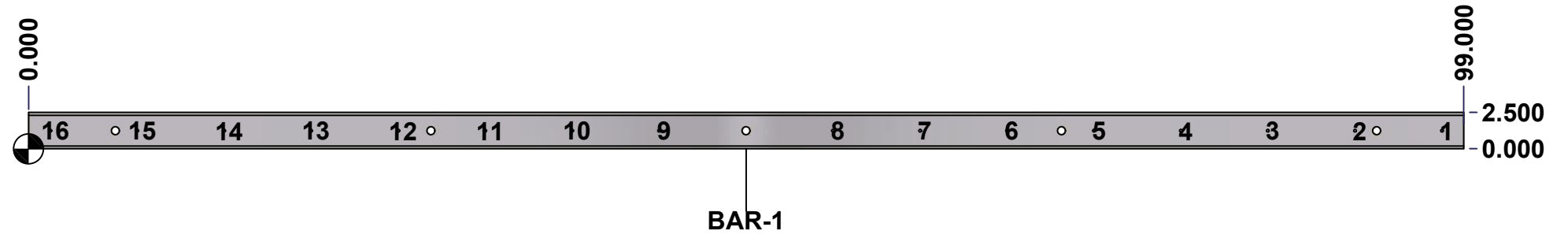

	Description	Status
	Rounded Edge Aluminum Bar 3/8" x 2 1/2"	(NULL)
	Part Number	Rev.
	Numéro Pièce	7
	1412BT11604DTBAR1-P	0
		17

This drawing is confidential and must not be reproduced or used without the consent of Eurobex

Ce dessin est confidentiel et ne doit pas être reproduit ou utilisé sans le consentement de Eurobex

STANDARD FEATURES ARE NOT LISTED IN THIS HOLE TABLE			
HOLE TABLE - FRONT VIEW (CUSTOM FEATURE ONLY)			
CUT-OUT	XDIM	YDIM	DESCRIPTION
1	97.500	1.250	RND Ø0.201 THREAD 1/4-20 UNC
2	91.500	1.250	RND Ø0.201 THREAD 1/4-20 UNC
3	85.500	1.250	RND Ø0.201 THREAD 1/4-20 UNC
4	79.500	1.250	RND Ø0.201 THREAD 1/4-20 UNC
5	73.500	1.250	RND Ø0.201 THREAD 1/4-20 UNC
6	67.500	1.250	RND Ø0.201 THREAD 1/4-20 UNC
7	61.500	1.250	RND Ø0.201 THREAD 1/4-20 UNC
8	55.500	1.250	RND Ø0.201 THREAD 1/4-20 UNC
9	43.500	1.250	RND Ø0.201 THREAD 1/4-20 UNC
10	37.500	1.250	RND Ø0.201 THREAD 1/4-20 UNC
11	31.500	1.250	RND Ø0.201 THREAD 1/4-20 UNC
12	25.500	1.250	RND Ø0.201 THREAD 1/4-20 UNC
13	19.500	1.250	RND Ø0.201 THREAD 1/4-20 UNC
14	13.500	1.250	RND Ø0.201 THREAD 1/4-20 UNC
15	7.500	1.250	RND Ø0.201 THREAD 1/4-20 UNC
16	1.500	1.250	RND Ø0.201 THREAD 1/4-20 UNC

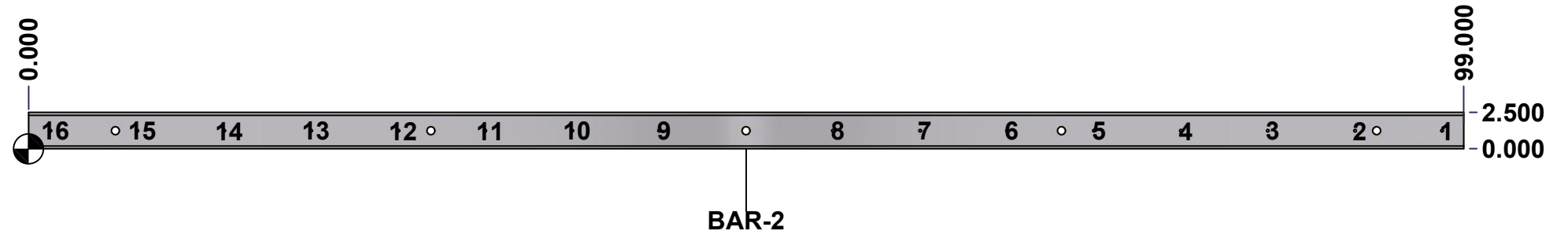

	Description	Status
	Rounded Edge Aluminum Bar 3/8" x 2 1/2"	(NULL)
	Part Number	Rev.
	Numéro Pièce 1412BT11604DTBAR2-P	0 / 8
		17

This drawing is confidential and must not be reproduced or used without the consent of Eurobex

Ce dessin est confidentiel et ne doit pas être reproduit ou utilisé sans le consentement de Eurobex

STANDARD FEATURES ARE NOT LISTED IN THIS HOLE TABLE			
HOLE TABLE - FRONT VIEW (CUSTOM FEATURE ONLY)			
CUT-OUT	XDIM	YDIM	DESCRIPTION
1	97.500	1.250	RND Ø0.201 THREAD 1/4-20 UNC
2	91.500	1.250	RND Ø0.201 THREAD 1/4-20 UNC
3	85.500	1.250	RND Ø0.201 THREAD 1/4-20 UNC
4	79.500	1.250	RND Ø0.201 THREAD 1/4-20 UNC
5	73.500	1.250	RND Ø0.201 THREAD 1/4-20 UNC
6	67.500	1.250	RND Ø0.201 THREAD 1/4-20 UNC
7	61.500	1.250	RND Ø0.201 THREAD 1/4-20 UNC
8	55.500	1.250	RND Ø0.201 THREAD 1/4-20 UNC
9	43.500	1.250	RND Ø0.201 THREAD 1/4-20 UNC
10	37.500	1.250	RND Ø0.201 THREAD 1/4-20 UNC
11	31.500	1.250	RND Ø0.201 THREAD 1/4-20 UNC
12	25.500	1.250	RND Ø0.201 THREAD 1/4-20 UNC
13	19.500	1.250	RND Ø0.201 THREAD 1/4-20 UNC
14	13.500	1.250	RND Ø0.201 THREAD 1/4-20 UNC
15	7.500	1.250	RND Ø0.201 THREAD 1/4-20 UNC
16	1.500	1.250	RND Ø0.201 THREAD 1/4-20 UNC

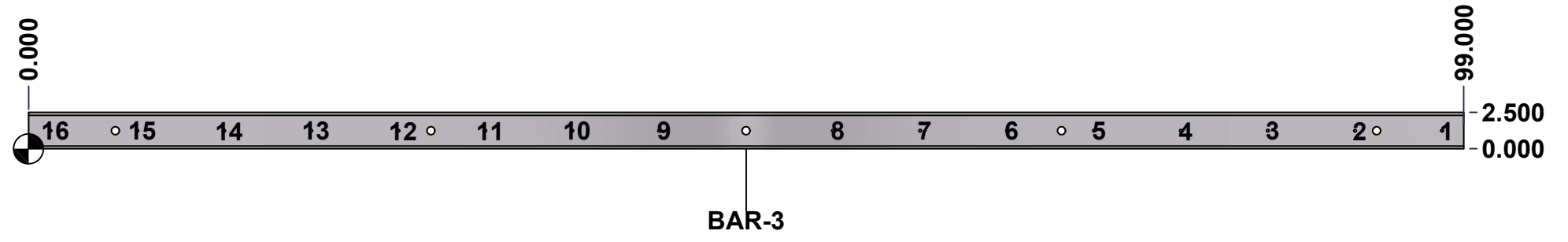

	Description	Status
	Rounded Edge Aluminum Bar 3/8" x 2 1/2"	(NULL)
	Part Number Numéro Pièce	Rev.
	1412BT11604DTBAR3-P	0 / 9
		17

This drawing is confidential and must not be reproduced or used without the consent of Eurobex

Ce dessin est confidentiel et ne doit pas être reproduit ou utilisé sans le consentement de Eurobex

STANDARD FEATURES ARE NOT LISTED IN THIS HOLE TABLE			
HOLE TABLE - FRONT VIEW (CUSTOM FEATURE ONLY)			
CUT-OUT	XDIM	YDIM	DESCRIPTION
1	97.500	1.250	RND Ø0.201 THREAD 1/4-20 UNC
2	91.500	1.250	RND Ø0.201 THREAD 1/4-20 UNC
3	85.500	1.250	RND Ø0.201 THREAD 1/4-20 UNC
4	79.500	1.250	RND Ø0.201 THREAD 1/4-20 UNC
5	73.500	1.250	RND Ø0.201 THREAD 1/4-20 UNC
6	67.500	1.250	RND Ø0.201 THREAD 1/4-20 UNC
7	61.500	1.250	RND Ø0.201 THREAD 1/4-20 UNC
8	55.500	1.250	RND Ø0.201 THREAD 1/4-20 UNC
9	43.500	1.250	RND Ø0.201 THREAD 1/4-20 UNC
10	37.500	1.250	RND Ø0.201 THREAD 1/4-20 UNC
11	31.500	1.250	RND Ø0.201 THREAD 1/4-20 UNC
12	25.500	1.250	RND Ø0.201 THREAD 1/4-20 UNC
13	19.500	1.250	RND Ø0.201 THREAD 1/4-20 UNC
14	13.500	1.250	RND Ø0.201 THREAD 1/4-20 UNC
15	7.500	1.250	RND Ø0.201 THREAD 1/4-20 UNC
16	1.500	1.250	RND Ø0.201 THREAD 1/4-20 UNC

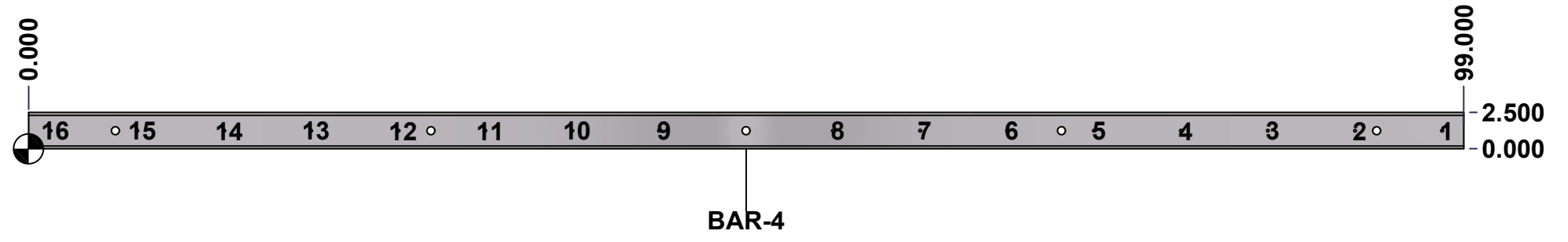

	Description	Status	
	Rounded Edge Aluminum Bar 3/8" x 2 1/2"	(NULL)	
	Part Number Numéro Pièce	Rev.	10
	1412BT11604DTBAR4-P	0	17

This drawing is confidential and must not be reproduced or used without the consent of EXM

Ce dessin est confidentiel et ne doit pas être reproduit ou utilisé sans le consentement de EXM

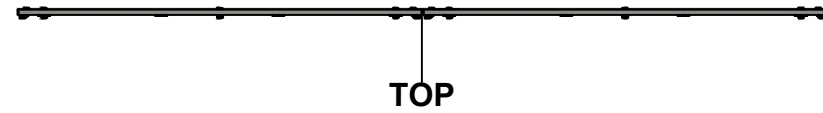

TOP

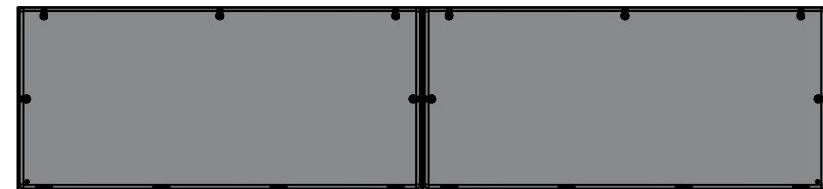

BACK



LEFT

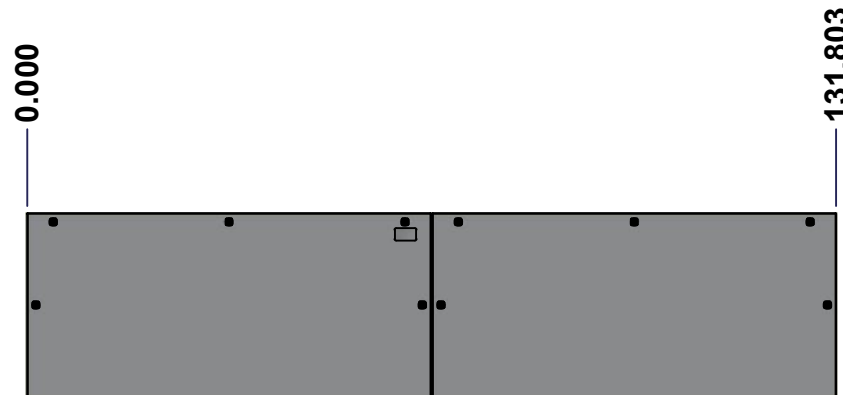

FRONT

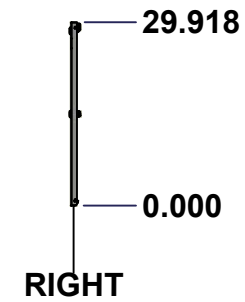

RIGHT



BOTTOM

No.	Revisions	Date	By/Par

Isometric View

Tél: (450) 979-4373 Fax: (450) 979-4626 www.exmweb.com		Flatness Aplatissement
		Max 3.0mm
Projection		Date
Customer Client	BoxCad: BoxCad	Date 2022-10-03
Material Matière	14 Ga Cold Rolled A1008 CS Type B (1.7mm)	
Color Couleur	Asa-61 Grey	Finish Fini Smooth
Description 1412BT 30" x 132" Cover		Detail Rev.
Part Number Numéro Pièce	1412BT11604DTC	Rev. 11 0 17

SEE BILL OF MATERIAL ON LAST PAGE

This drawing is confidential and must not be reproduced or used without the consent of Eurobox

Ce dessin est confidentiel et ne doit pas être reproduit ou utilisé sans le consentement de Eurobox

STANDARD FEATURES ARE NOT LISTED IN THIS HOLE TABLE			
HOLE TABLE - FRONT VIEW (CUSTOM FEATURE ONLY)			
CUT-OUT	XDIM	YDIM	DESCRIPTION
1	1.500	1.486	GND STUD M6 x 16mm (Inside)
2	130.303	1.486	GND STUD M6 x 16mm (Inside)
3	130.379	14.959	LOCK 880 SCQ4-SL @ 0.0°
4	67.424	14.959	LOCK 880 SCQ4-SL @ 180.0°
5	64.379	14.959	LOCK 880 SCQ4-SL @ 0.0°
6	1.424	14.959	LOCK 880 SCQ4-SL @ 180.0°
7	127.553	28.494	LOCK 880 SCQ4-SL @ 90.0°
8	98.902	28.494	LOCK 880 SCQ4-SL @ 90.0°
9	70.250	28.494	LOCK 880 SCQ4-SL @ 90.0°
10	61.553	28.494	LOCK 880 SCQ4-SL @ 90.0°
11	32.902	28.494	LOCK 880 SCQ4-SL @ 90.0°
12	4.250	28.494	LOCK 880 SCQ4-SL @ 90.0°

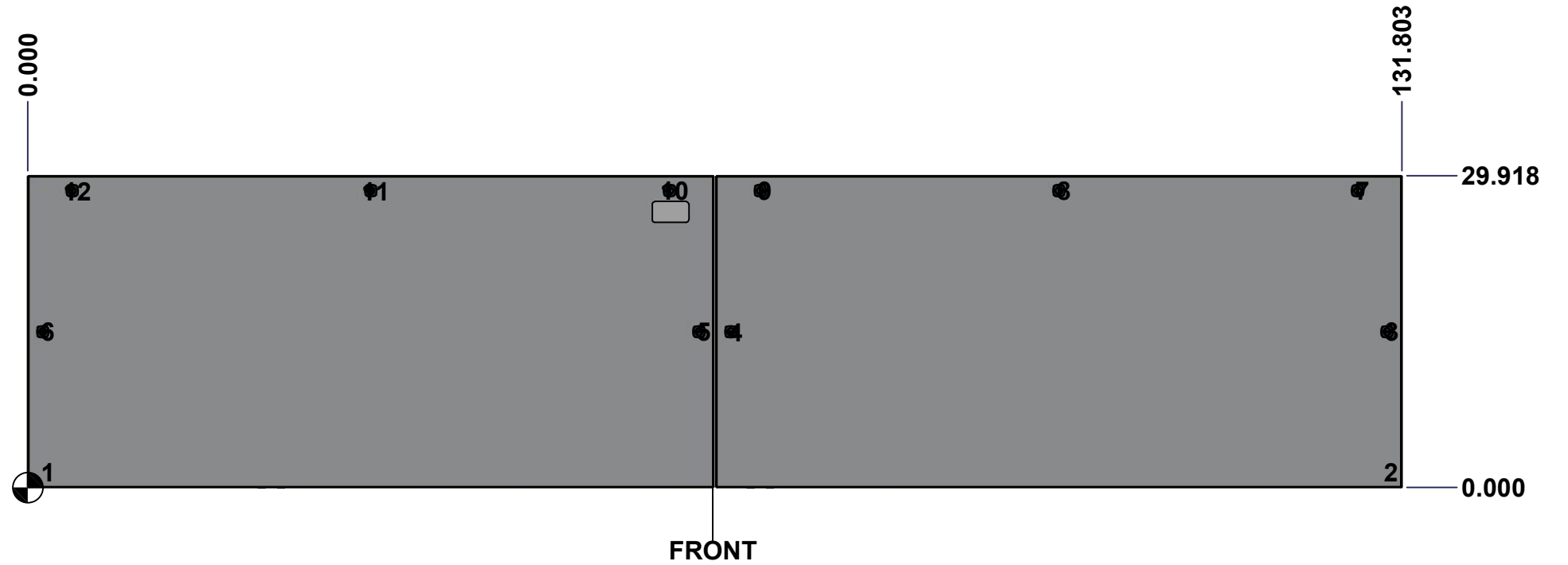

	Description 1412BT 30" x 132" Cover	Status (NULL)
	Part Number Numéro Pièce 1412BT11604DTC	Rev. 12 0 17

This drawing is confidential and must not be reproduced or used without the consent of EXM

Ce dessin est confidentiel et ne doit pas être reproduit ou utilisé sans le consentement de EXM

No.	Revisions	Date	By/Par

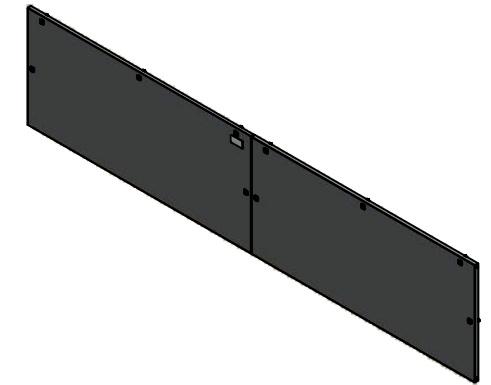

Isometric View



Tél: (450) 979-4373
 Fax: (450) 979-4626
www.exmweb.com

Flatness
Aplatissement

Max 3.0mm

Projection

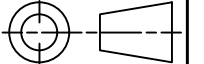

Customer Client	Date
Drawn By / Dessiné Par: BoxCad: BoxCad	Date: 2022-10-03

Material / Matière: 14 Ga Cold Rolled A1008 CS Type B (1.7mm)

Color / Couleur: Asa-61 Grey Finish / Fini: Smooth

Description: 1412BT 30" x 132" Cover Detail Rev.

Part Number / Numéro Pièce: **1412BT11604DTC** Rev. **0** 13 / 17

2	1412BT11604DTG	0	1412BT 30" x 132" Cover Gasket
1	STK-P-02400S	0	Powder Paint (Asa-61 Grey / Smooth)
8	STK-K-09800	10	5412 ES Hinge with 2 Captive Hinge Pins
2	STK-Q-16080	0	Ground Stud M6 x 16mm
1	STK-S-00100	0	3.5" x 2" Silver Milar Flexcon Sticker
1	1412BT11604DTC-P	0	1412BT 30" x 66" Left Cover Part
1	1412BT11604DTF-P	0	1412BT 30" x 132" Right Cover Part
10	880 SCQ4-SL	6	5412 ES 1/4 Turn Lock
Qty	Part Name	Rev	Description
Parts List			

This drawing is confidential and must not be reproduced or used without the consent of EXM

Ce dessin est confidentiel et ne doit pas être reproduit ou utilisé sans le consentement de EXM

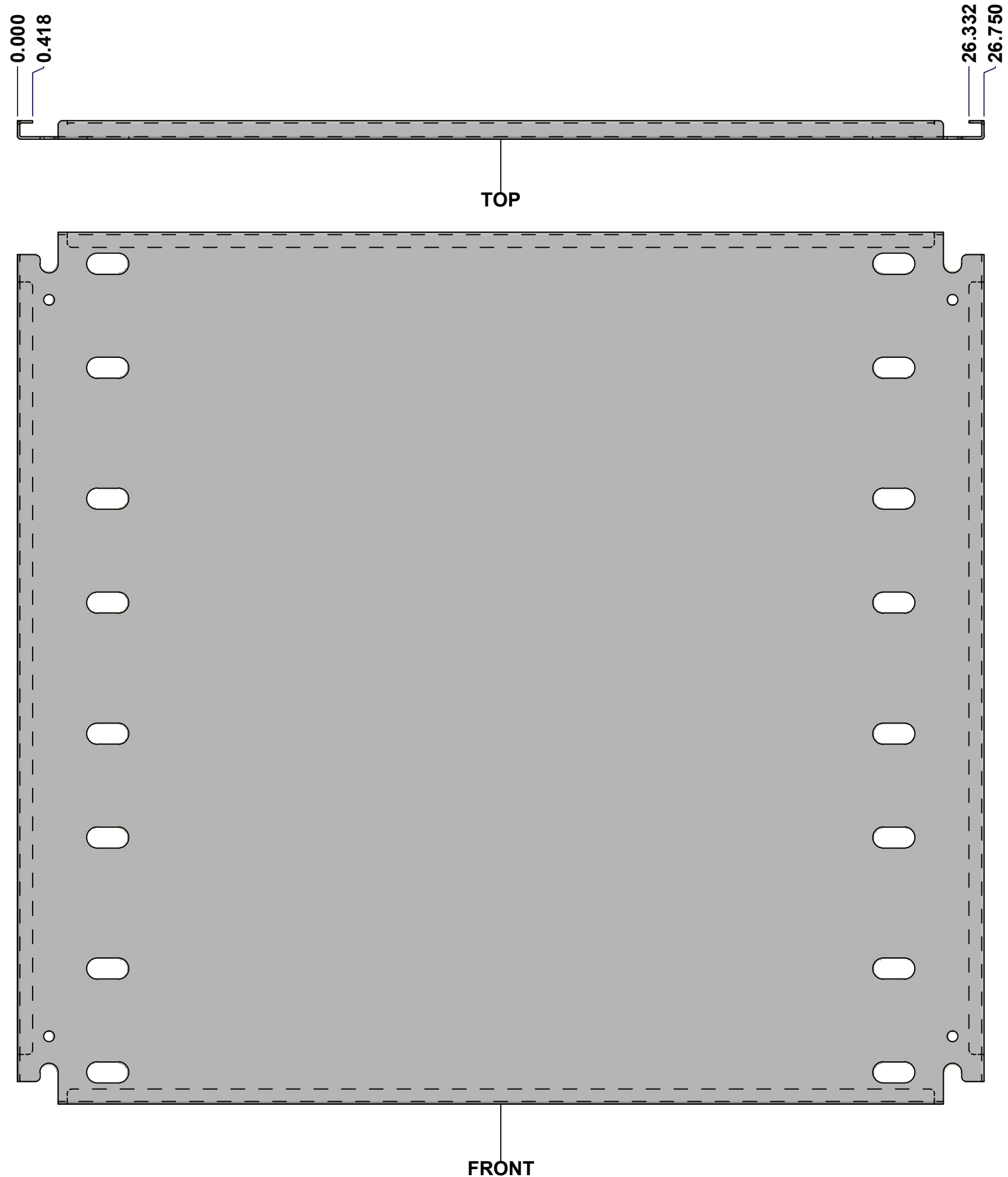

No.	Revisions	Date	By/Par

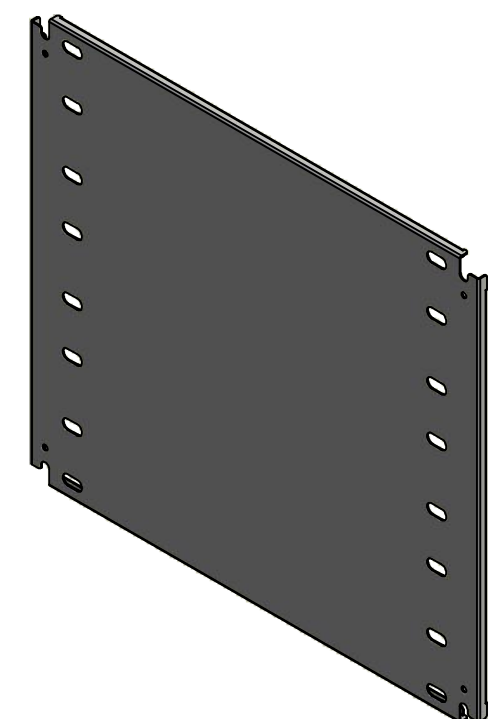

Isometric View

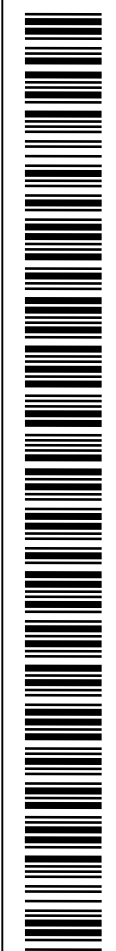

<p>Tél: (450) 979-4373 Fax: (450) 979-4626 www.exmweb.com</p>	Flatness Aplatissement Max 3.0mm
	Projection
Customer Client	Date
Drawn By / Dessiné Par: BoxCad: BoxCad	Date: 2022-10-03
Material / Matière: 14 Ga Cold Rolled A1008 CS Type B (1.7mm)	
Color / Couleur: White RAL9003	Finish / Fini: Smooth
Description: 1412BT 24.125" x 26.75" Left Inner Panel	
Part Number / Numéro Pièce: 1412BT11604DTIP1	Detail Rev. / Rev. 0
	14 / 17

SEE BILL OF MATERIAL ON LAST PAGE

This drawing is confidential and must not be reproduced or used without the consent of EXM

Ce dessin est confidentiel et ne doit pas être reproduit ou utilisé sans le consentement de EXM

No.	Revisions	Date	By/Par

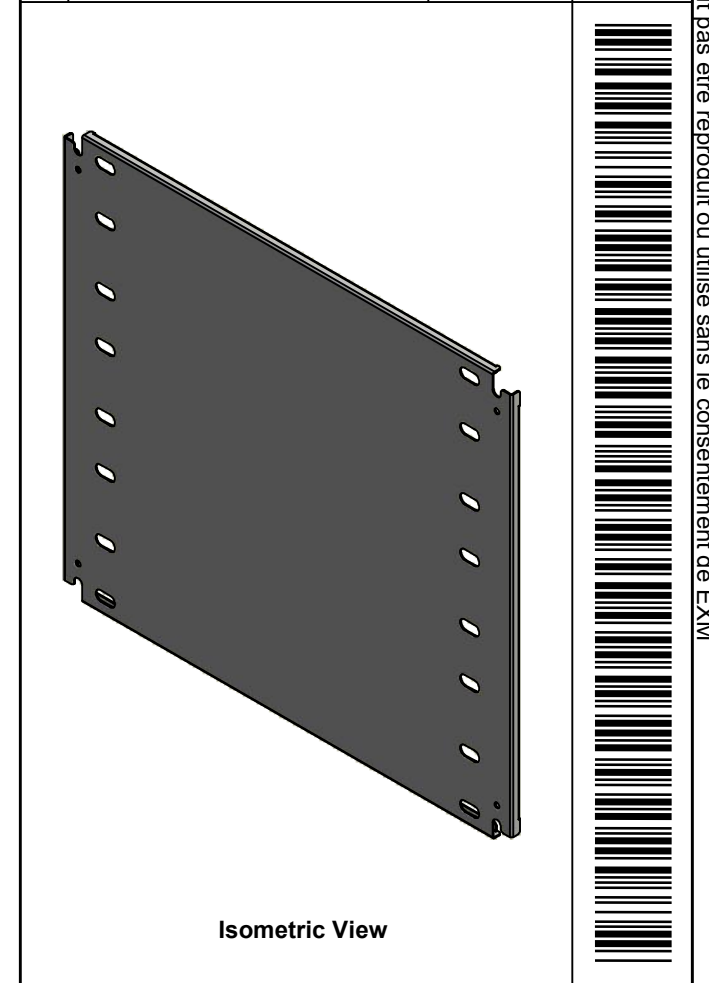

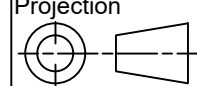
 Tél: (450) 979-4373 Fax: (450) 979-4626 www.exmweb.com		Flatness Aplatissement Max 3.0mm Projection 
Customer Client	Date	
Drawn By / Dessiné Par: BoxCad: BoxCad	Date: 2022-10-03	
Material / Matière: 14 Ga Cold Rolled A1008 CS Type B (1.7mm)		
Color / Couleur: White RAL9003	Finish / Fini: Smooth	
Description: 1412BT 24.125" x 26.75" Left Inner Panel		Detail Rev.
Part Number / Numéro Pièce: 1412BT11604DTIP1	Rev.:	15
		17

Qty	Part Number	Rev	Description
1	STK-P-02401S	0	Powder Paint (White / Smooth)
1	1412BT11604DTIP1-P	0	1412BT 24.125" x 132" Left Inner Panel Part
Parts List			

This drawing is confidential and must not be reproduced or used without the consent of EXM

Ce dessin est confidentiel et ne doit pas être reproduit ou utilisé sans le consentement de EXM

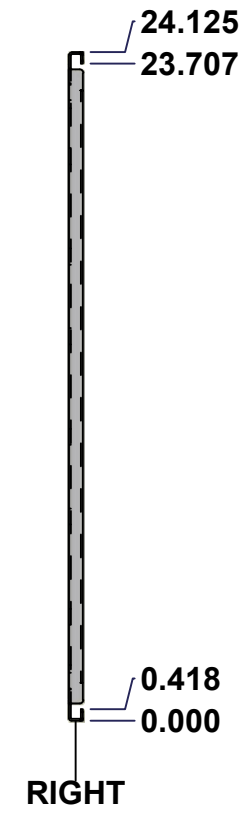
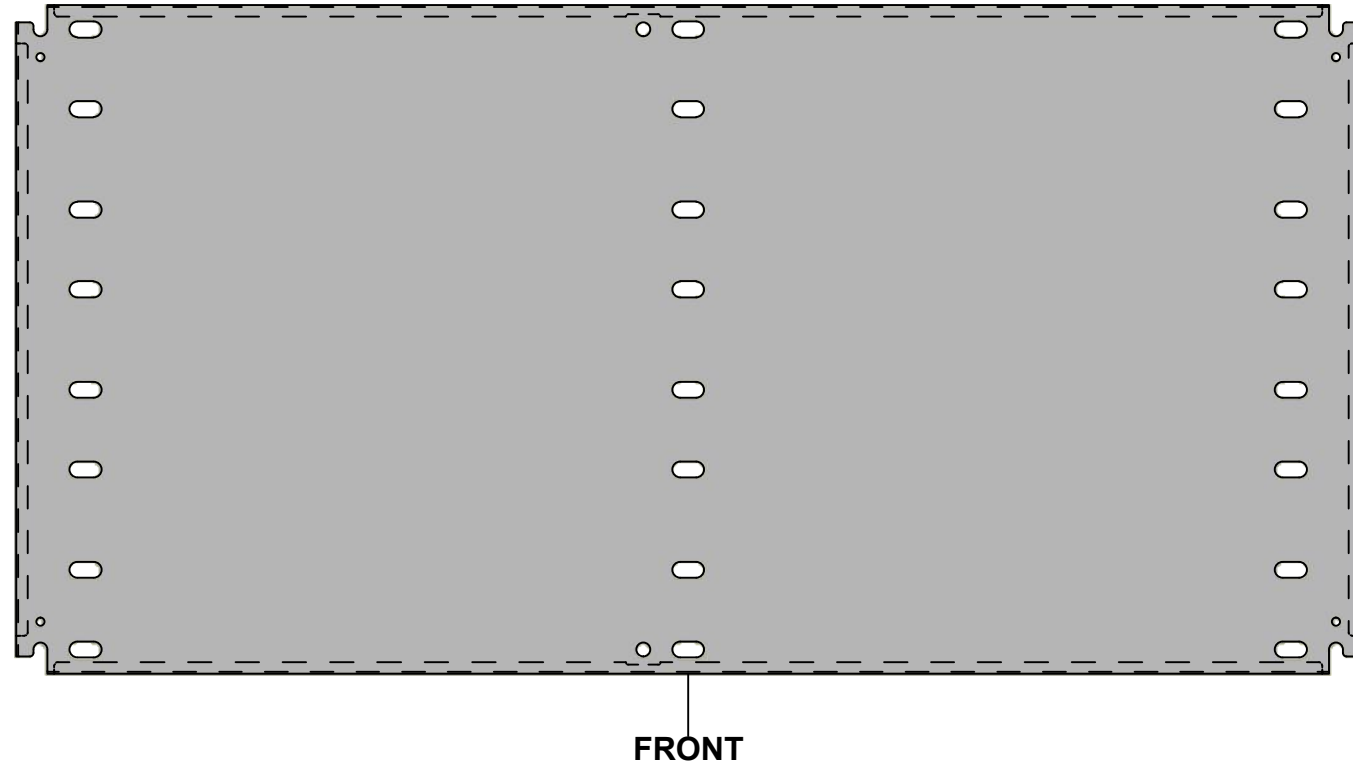
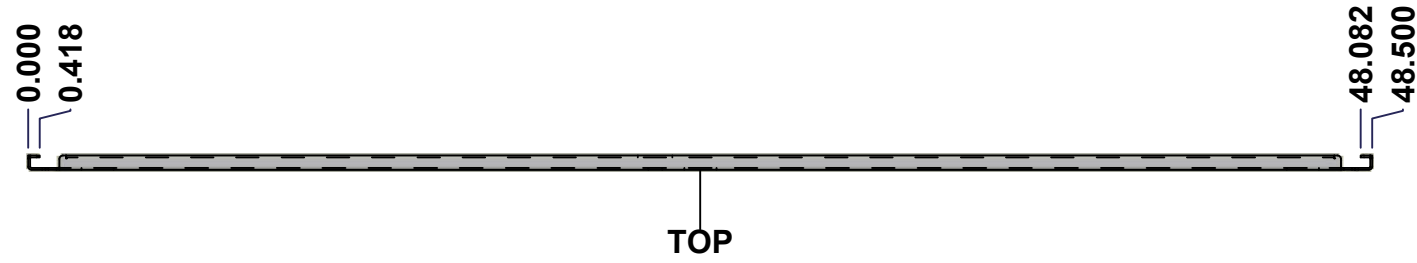

No.	Revisions	Date	By/Par

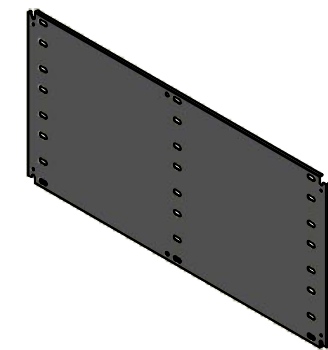

Isometric View

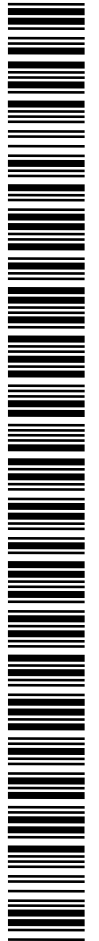

Tél: (450) 979-4373
Fax: (450) 979-4626
www.exmweb.com

Flatness
Aplatissement
Max 3.0mm
Projection

Customer Client	Date
Drawn By / Dessiné Par: BoxCad: BoxCad	Date: 2022-10-03
Material / Matière: 14 Ga Cold Rolled A1008 CS Type B (1.7mm)	
Color / Couleur: White RAL9003	Finish / Fini: Smooth
Description: 1412BT 24.125" x 48.5" Right Inner Panel	Detail Rev.
Part Number / Numéro Pièce: 1412BT11604DTIP2	Rev. 0
	16 / 17

SEE BILL OF MATERIAL ON LAST PAGE

This drawing is confidential and must not be reproduced or used without the consent of EXM

Ce dessin est confidentiel et ne doit pas être reproduit ou utilisé sans le consentement de EXM

No.	Revisions	Date	By/Par

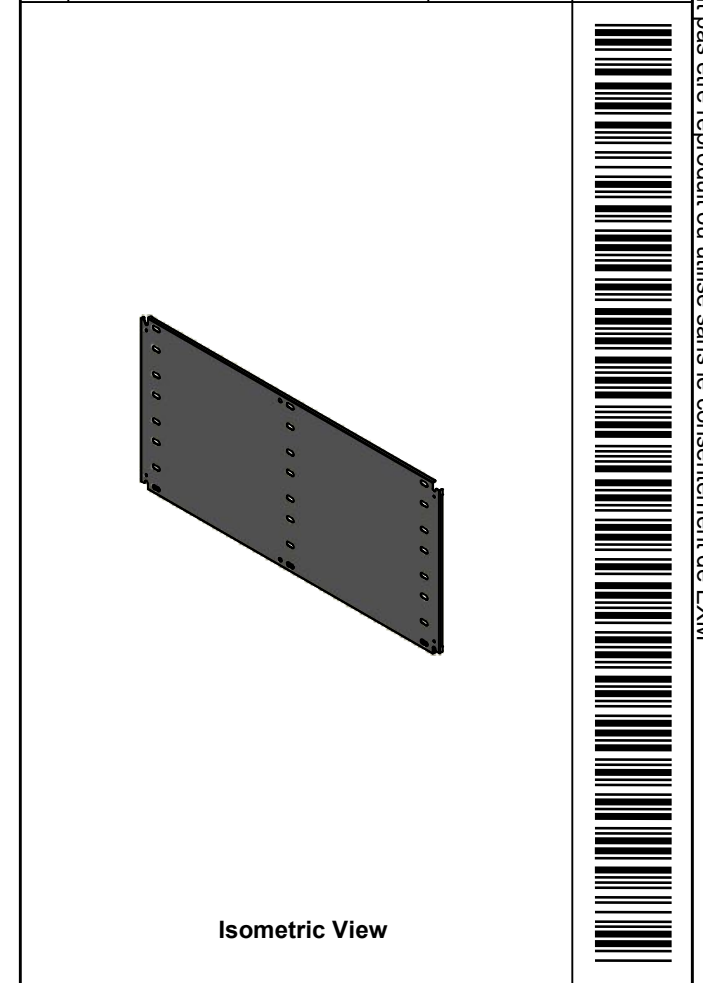

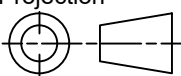
 Tél: (450) 979-4373 Fax: (450) 979-4626 www.exmweb.com		Flatness Aplatissement Max 3.0mm
Customer Client		Projection 
Drawn By / Dessiné Par: BoxCad: BoxCad		Date: 2022-10-03
Material / Matière: 14 Ga Cold Rolled A1008 CS Type B (1.7mm)		
Color / Couleur: White RAL9003	Finish / Fini: Smooth	
Description: 1412BT 24.125" x 48.5" Right Inner Panel		Detail Rev.
Part Number / Numéro Pièce: 1412BT11604DTIP2		Rev. 17 0

Qty	Part Number	Rev	Description
1	STK-P-02401S	0	Powder Paint (White / Smooth)
1	1412BT11604DTIP2-P	0	1412BT 24.125" x 132" Right Inner Panel Part
Parts List			