

This drawing is confidential and must not be reproduced or used without the consent of EXM

Ce dessin est confidentiel et ne doit pas être reproduit ou utilisé sans le consentement de EXM



TOP



BACK

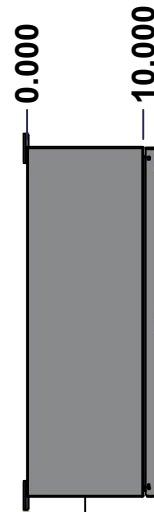

LEFT

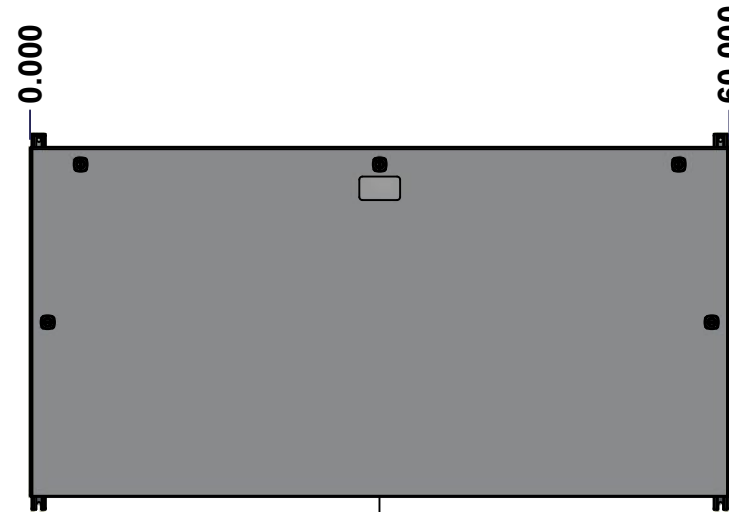

FRONT

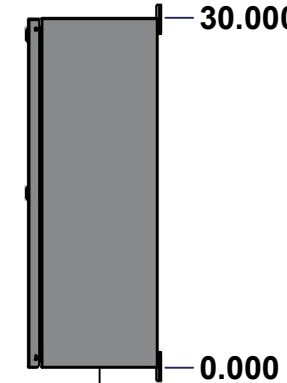

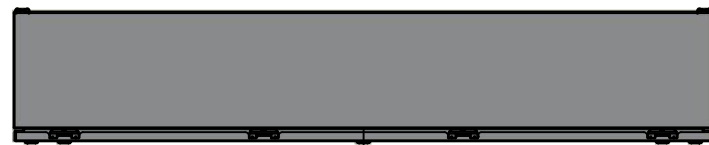

RIGHT

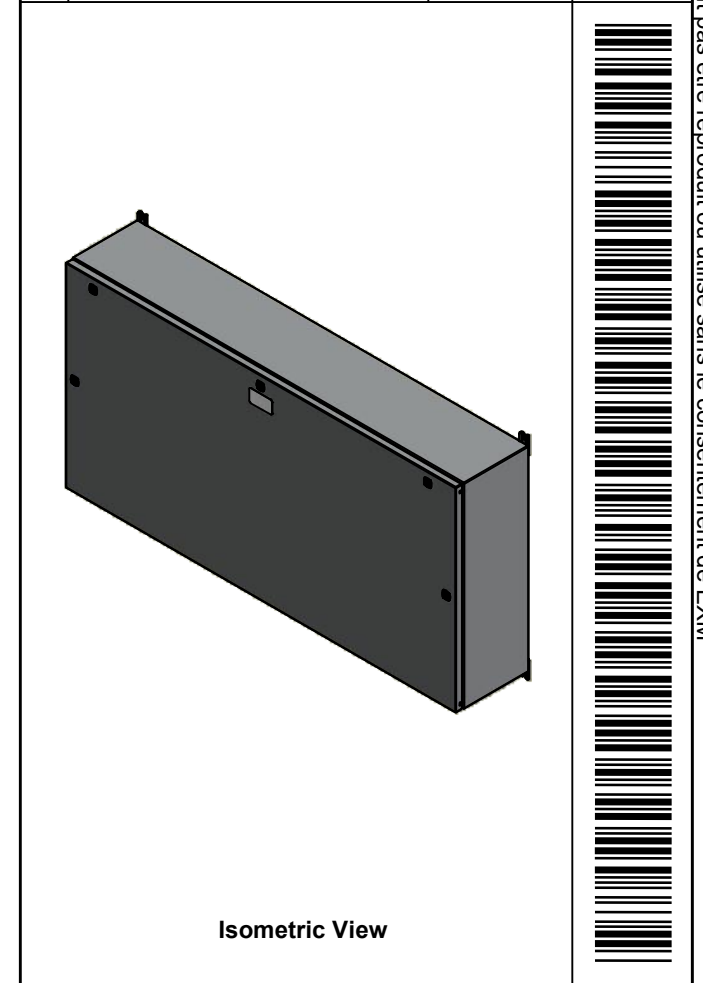

BOTTOM

No.	Revisions	Date	By/Par

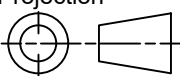

 Tél: (450) 979-4373 Fax: (450) 979-4626 www.exmweb.com		Flatness Aplatissement Max 3.0mm Projection 
Customer Client	Date	
Drawn By Dessiné Par	BoxCad: BoxCad	Date 2022-10-21
Material Matière	14 Ga Cold Rolled A1008 CS Type B (1.7mm)	
Color Couleur	Asa-61 Grey	Finish Fini Smooth
Description 1412BTCU 1200A - 4Wires x 60" Assembly		Detail Rev.
Part Number Numéro Pièce	Rev. 0	1 / 15

SEE BILL OF MATERIAL ON LAST PAGE

1412BTCU051204DT

This drawing is confidential and must not be reproduced or used without the consent of Eurobox

Ce dessin est confidentiel et ne doit pas être reproduit ou utilisé sans le consentement de Eurobox

STANDARD FEATURES ARE NOT LISTED IN THIS HOLE TABLE

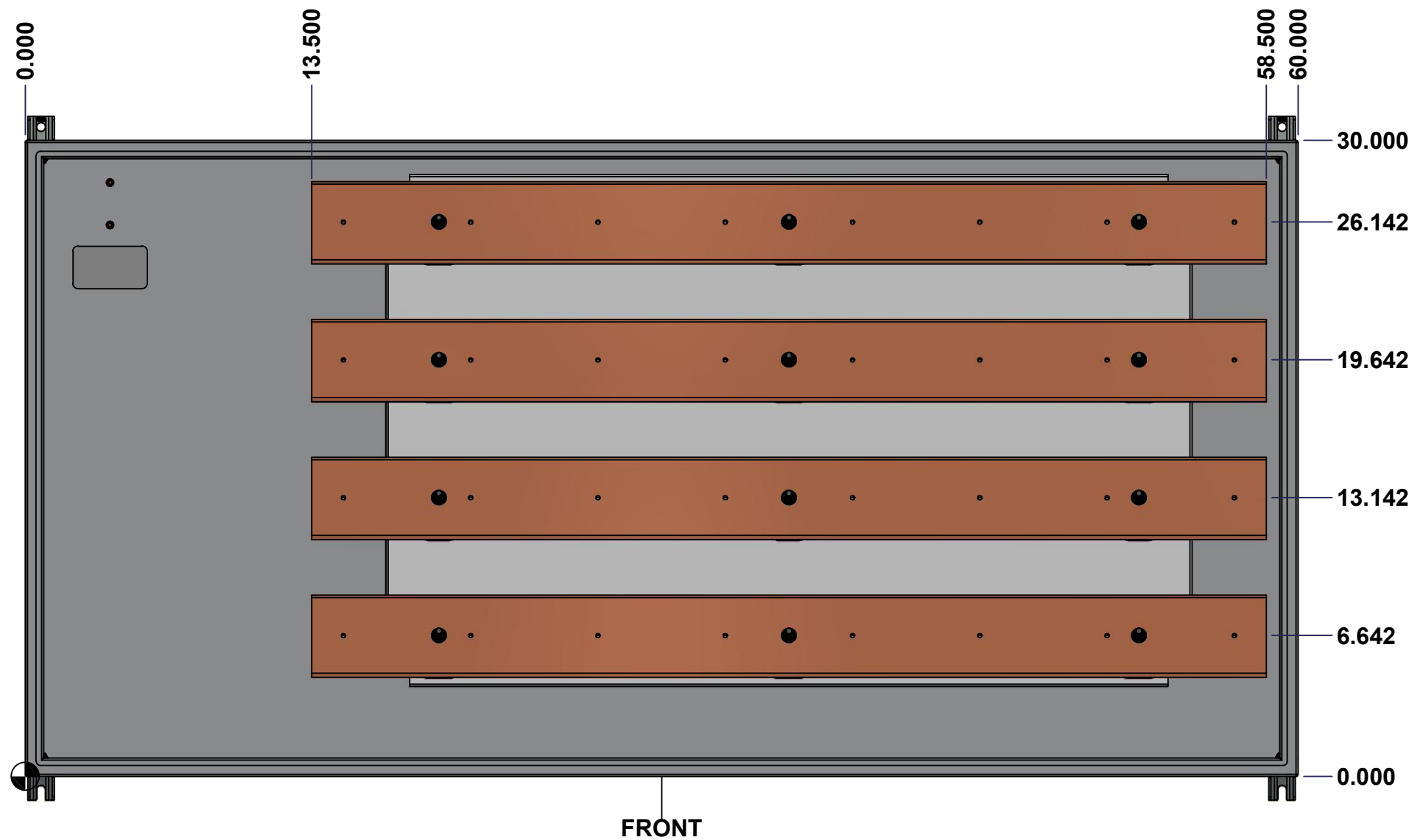

	Description		Status
	1412BTCU 1200A - 4Wires x 60" Assembly		(NULL)
Part Number		Rev.	2
Numéro Pièce		0	15
1412BTCU051204DT			

This drawing is confidential and must not be reproduced or used without the consent of EXM

Ce dessin est confidentiel et ne doit pas être reproduit ou utilisé sans le consentement de EXM

NOTE	
ITEM	DESCRIPTION
1	NEMA 4/12 Enclosure
2	C/W Standard ground studs on box and cover
3	W/O Standard door stiffener
4	C/W Special inner panel (Sold separately)
5	C/W Standard inner panel mounting studs

No.	Revisions	Date	By/Par

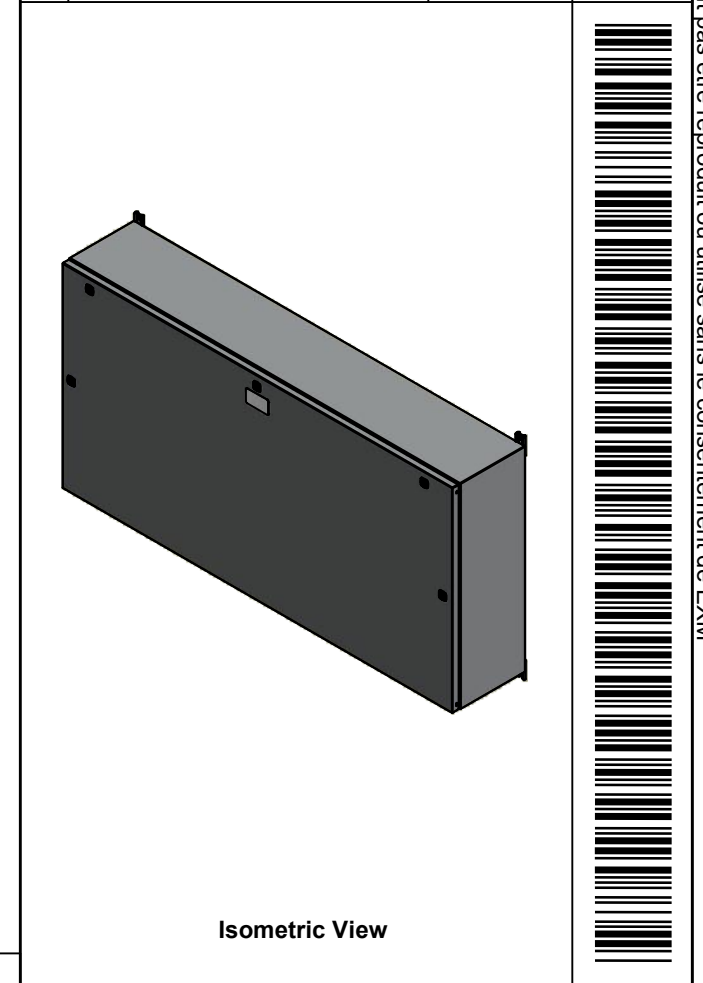

PACKING		
ITEM	QTY	DESCRIPTION
Cardboard sleeve	2	Top and Bottom
Cardboard strip	2	Between back of enclosure and inner panel
Plastic bag	1	To protect cover surface and inside gasket
Cardboard corner	4	To reinforced for the plastic strap tightening
Plastic strap - Black	2	To Squeeze 2 cardboard sleeve together
Packaging label	3	White label with PN
Plastic strap- Green	2	To secure the enclosure to the wood pallet
Wood Pallet	1	2" deeper and 3" larger than enclosure size

1	885 ESMF1	0	885 ESMF1 Mounting Feet Kit
1	1412BTCU051204DTBAR 4-P	0	Rounded Edge Copper Bar 5/16" x 4"
1	1412BTCU051204DTBAR 1-P	0	Rounded Edge Copper Bar 5/16" x 4"
1	1412BTCU051204DTBAR 2-P	0	Rounded Edge Copper Bar 5/16" x 4"
1	1412BTCU051204DTBAR 3-P	0	Rounded Edge Copper Bar 5/16" x 4"
1	1412BTCU051204DTIP1	0	1412BTCU 24.125" x 38" Inner Panel
12	STK-A-67400	0	Buss Bar Insulator Kit
1	STK-K-01800	5	5412 ES Accessory Kit
4	STK-Q-04050-07	7	M6 x 7mm Hexagon Socket Head Machine Screw with Nyseal
18	STK-Q-07310	2	Flange Lock Nut M8
6	STK-Q-07610	8	M8 Plastic Spacer 22.2mm
1	1412BTCU051204DTB	0	1412BTCU 30" x 60" x 10" Body
1	1412BTCU051204DTC	0	1412BTCU 30" x 60" Cover
Qty	Part Number	Rev	Description
Parts List			

Tél: (450) 979-4373
Fax: (450) 979-4626
www.exmweb.com

Flatness
Aplatissement
Max 3.0mm

Projection

Customer Client	Date
Drawn By Dessiné Par BoxCad: BoxCad	Date 2022-10-21
Material Matière 14 Ga Cold Rolled A1008 CS Type B (1.7mm)	
Color Couleur Asa-61 Grey	Finish Fini Smooth
Description 1412BTCU 1200A - 4Wires x 60" Assembly	Detail Rev.
Part Number Numéro Pièce 1412BTCU051204DT	Rev. 0

This drawing is confidential and must not be reproduced or used without the consent of EXM

Ce dessin est confidentiel et ne doit pas être reproduit ou utilisé sans le consentement de EXM



TOP



BACK

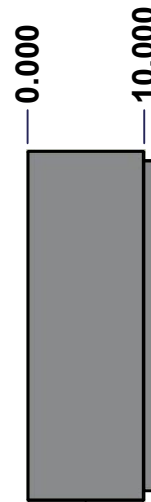

LEFT

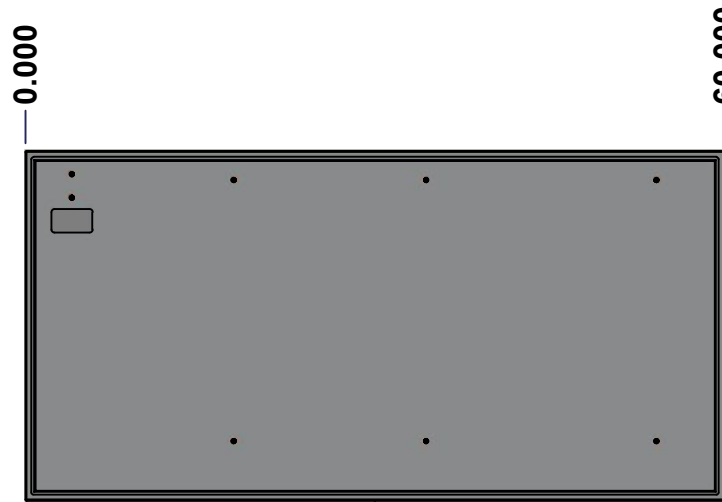

FRONT





RIGHT

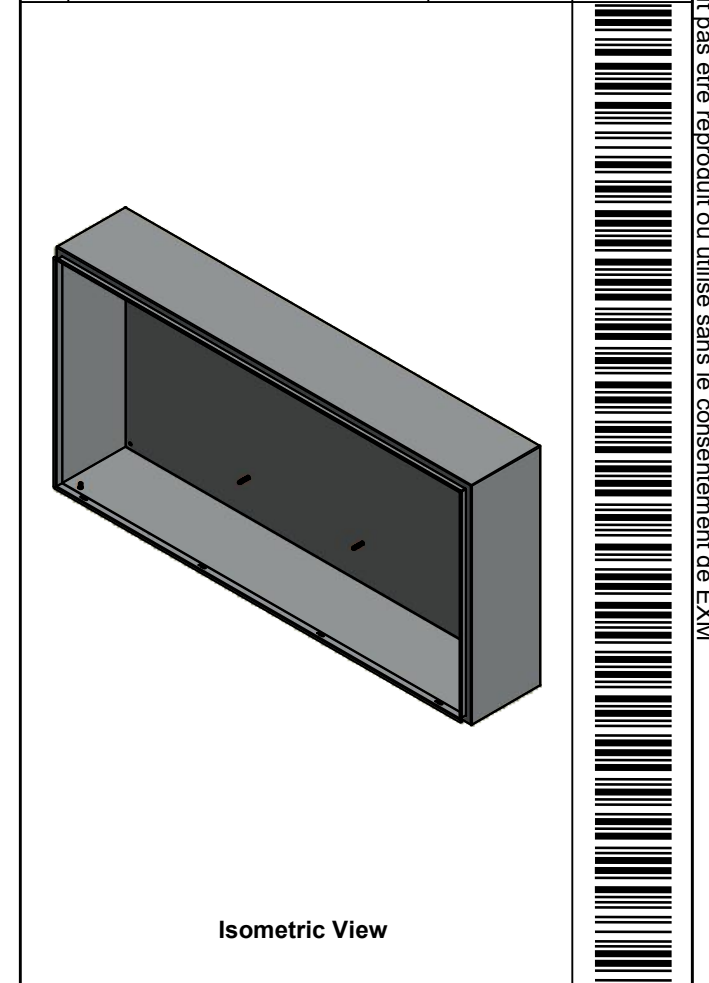

BOTTOM

No.	Revisions	Date	By/Par

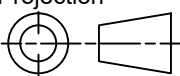

 Tél: (450) 979-4373 Fax: (450) 979-4626 www.exmweb.com		Flatness Aplatissement Max 3.0mm Projection 
Customer Client	Date	
Drawn By Dessiné Par	BoxCad: BoxCad	Date 2022-10-21
Material Matière	14 Ga Cold Rolled A1008 CS Type B (1.7mm)	
Color Couleur	Asa-61 Grey	Finish Fini Smooth
Description	Detail Rev.	
1412BTCU 30" x 60" x 10" Body		
Part Number Numéro Pièce	Rev.	4
1412BTCU051204DTB	0	15

SEE BILL OF MATERIAL ON LAST PAGE

This drawing is confidential and must not be reproduced or used without the consent of Eurobox

Ce dessin est confidentiel et ne doit pas être reproduit ou utilisé sans le consentement de Eurobox

STANDARD FEATURES ARE NOT LISTED IN THIS HOLE TABLE

HOLE TABLE - BACK VIEW (CUSTOM FEATURE ONLY)

CUT-OUT	XDIM	YDIM	DESCRIPTION
1	56.000	28.000	GND STUD M8 x 35mm (Inside)
2	56.000	26.000	GND STUD M8 x 35mm (Inside)
3	5.875	27.500	IP STUD M8 x 35mm (Inside)
4	42.125	27.500	IP STUD M8 x 35mm (Inside)
5	5.875	5.125	IP STUD M8 x 35mm (Inside)
6	42.125	5.125	IP STUD M8 x 35mm (Inside)
7	25.625	27.500	IP STUD M8 x 35mm (Inside)
8	25.625	5.125	IP STUD M8 x 35mm (Inside)

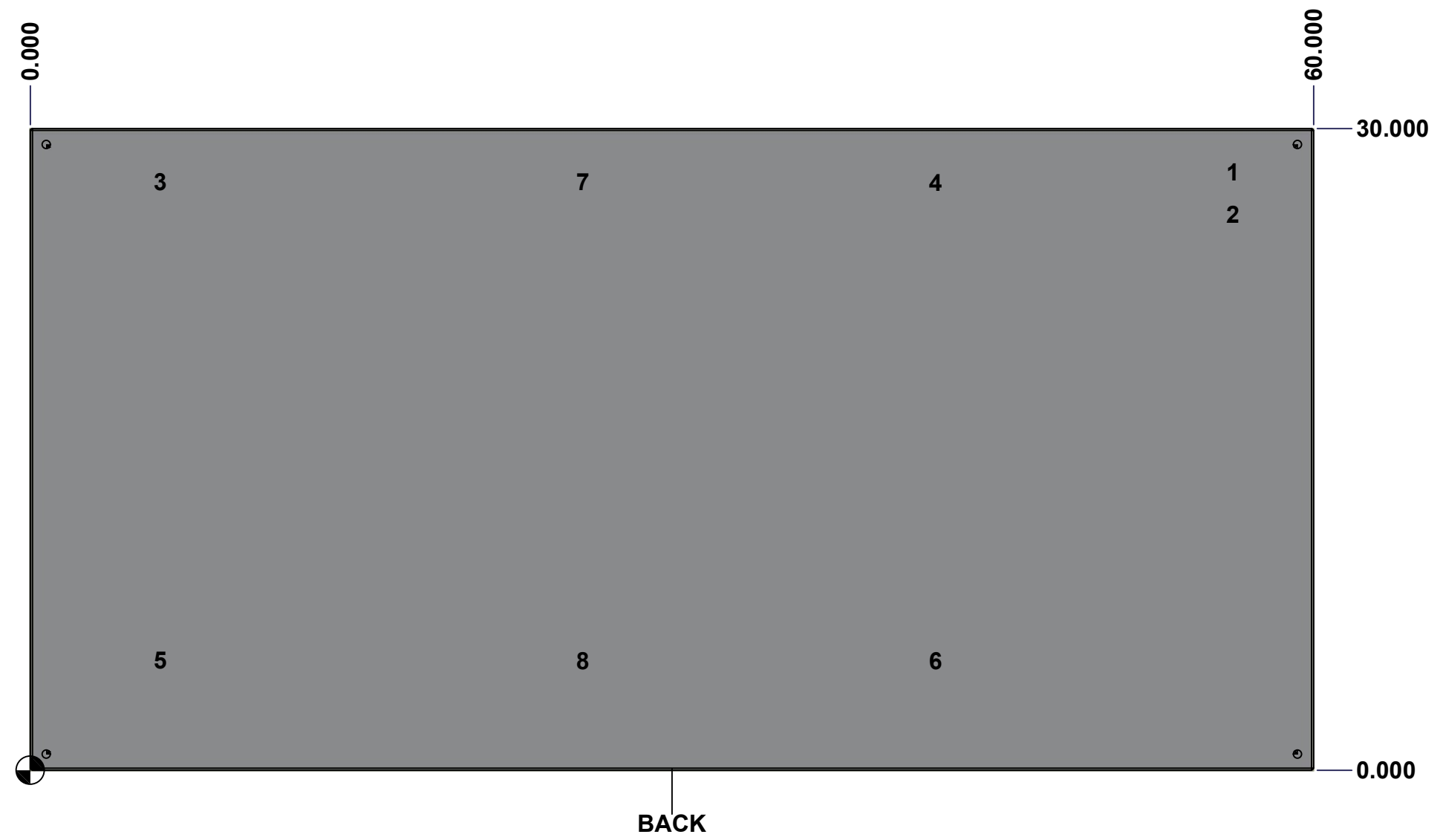



	Description	Status
	1412BTCU 30" x 60" x 10" Body	(NULL)
	Part Number Numéro Pièce	Rev.
	1412BTCU051204DTB	0 / 5
		15

This drawing is confidential and must not be reproduced or used without the consent of EXM

Ce dessin est confidentiel et ne doit pas être reproduit ou utilisé sans le consentement de EXM

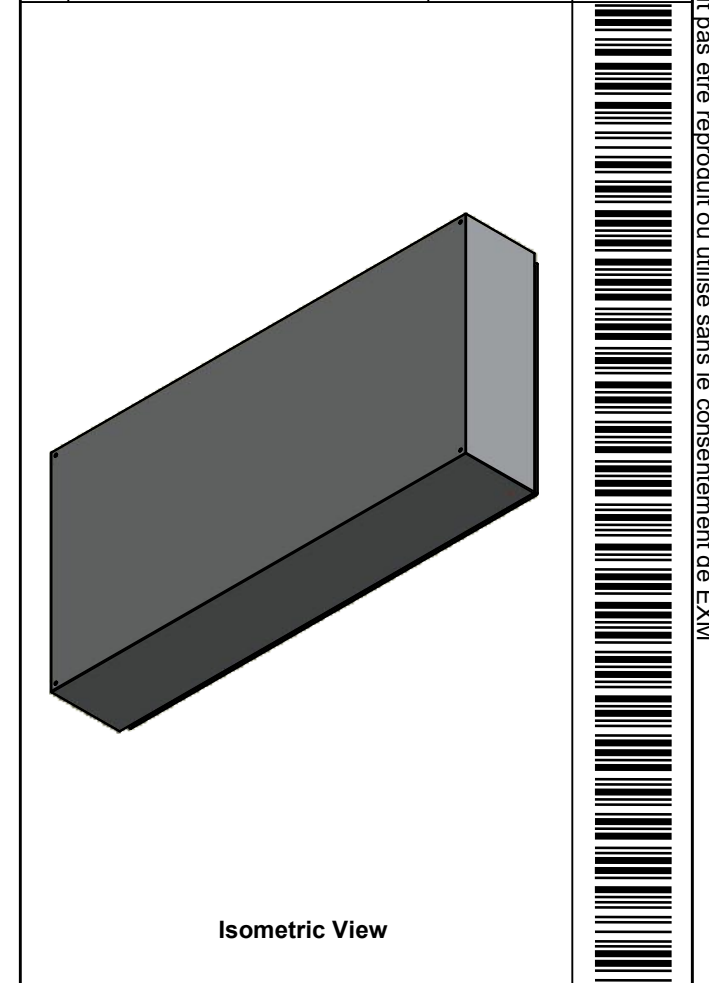
No.	Revisions	Date	By/Par

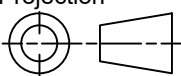

 Tél: (450) 979-4373 Fax: (450) 979-4626 www.exmweb.com		Flatness Aplatissement Max 3.0mm
Customer Client		Projection 
Drawn By / Dessiné Par: BoxCad: BoxCad		Date: 2022-10-21
Material / Matière: 14 Ga Cold Rolled A1008 CS Type B (1.7mm)		
Color / Couleur: Asa-61 Grey	Finish / Fini: Smooth	
Description: 1412BTCU 30" x 60" x 10" Body		Detail Rev.
Part Number / Numéro Pièce: 1412BTCU051204DTB		Rev. 6 0

Qty	Part Number	Rev	Description
1	STK-P-02400S	0	Powder Paint (Asa-61 Grey / Smooth)
8	STK-Q-16005	1	Stud M8 x 35 (No Paint Cap Required)
1	STK-Q-16080	0	Ground Stud M6 x 16mm
1	STK-S-00100	0	3.5" x 2" Silver Milar Flexcon Sticker
1	1412BTCU051204DTB-P	0	1412BTCU 30" x 60" x 10" Body Part
Parts List			

This drawing is confidential and must not be reproduced or used without the consent of Eurobox

Ce dessin est confidentiel et ne doit pas être reproduit ou utilisé sans le consentement de Eurobox

STANDARD FEATURES ARE NOT LISTED IN THIS HOLE TABLE

HOLE TABLE - FRONT VIEW (CUSTOM FEATURE ONLY)

CUT-OUT	XDIM	YDIM	DESCRIPTION
1	43.500	2.000	RND Ø0.201 THREAD 1/4-20 UNC
2	37.500	2.000	RND Ø0.201 THREAD 1/4-20 UNC
3	31.500	2.000	RND Ø0.201 THREAD 1/4-20 UNC
4	25.500	2.000	RND Ø0.201 THREAD 1/4-20 UNC
5	19.500	2.000	RND Ø0.201 THREAD 1/4-20 UNC
6	13.500	2.000	RND Ø0.201 THREAD 1/4-20 UNC
7	7.500	2.000	RND Ø0.201 THREAD 1/4-20 UNC
8	1.500	2.000	RND Ø0.201 THREAD 1/4-20 UNC

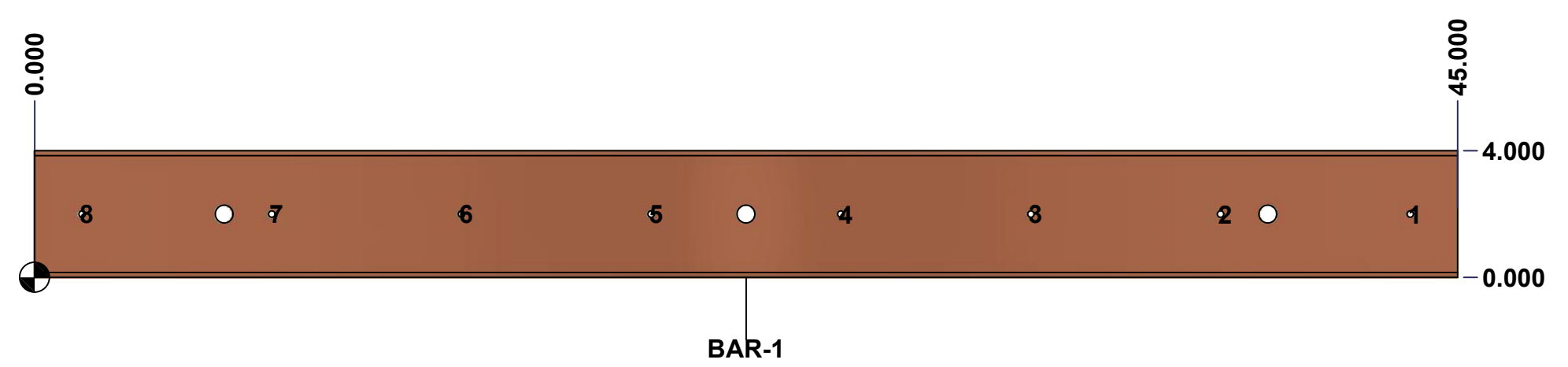

	Description	Status
	Rounded Edge Copper Bar 5/16" x 4"	(NULL)
	Part Number Numéro Pièce	Rev.
	1412BTCU051204DTBAR1-P	7
	0	15

This drawing is confidential and must not be reproduced or used without the consent of Eurobox

Ce dessin est confidentiel et ne doit pas être reproduit ou utilisé sans le consentement de Eurobox

STANDARD FEATURES ARE NOT LISTED IN THIS HOLE TABLE

HOLE TABLE - FRONT VIEW (CUSTOM FEATURE ONLY)

CUT-OUT	XDIM	YDIM	DESCRIPTION
1	43.500	2.000	RND Ø0.201 THREAD 1/4-20 UNC
2	37.500	2.000	RND Ø0.201 THREAD 1/4-20 UNC
3	31.500	2.000	RND Ø0.201 THREAD 1/4-20 UNC
4	25.500	2.000	RND Ø0.201 THREAD 1/4-20 UNC
5	19.500	2.000	RND Ø0.201 THREAD 1/4-20 UNC
6	13.500	2.000	RND Ø0.201 THREAD 1/4-20 UNC
7	7.500	2.000	RND Ø0.201 THREAD 1/4-20 UNC
8	1.500	2.000	RND Ø0.201 THREAD 1/4-20 UNC

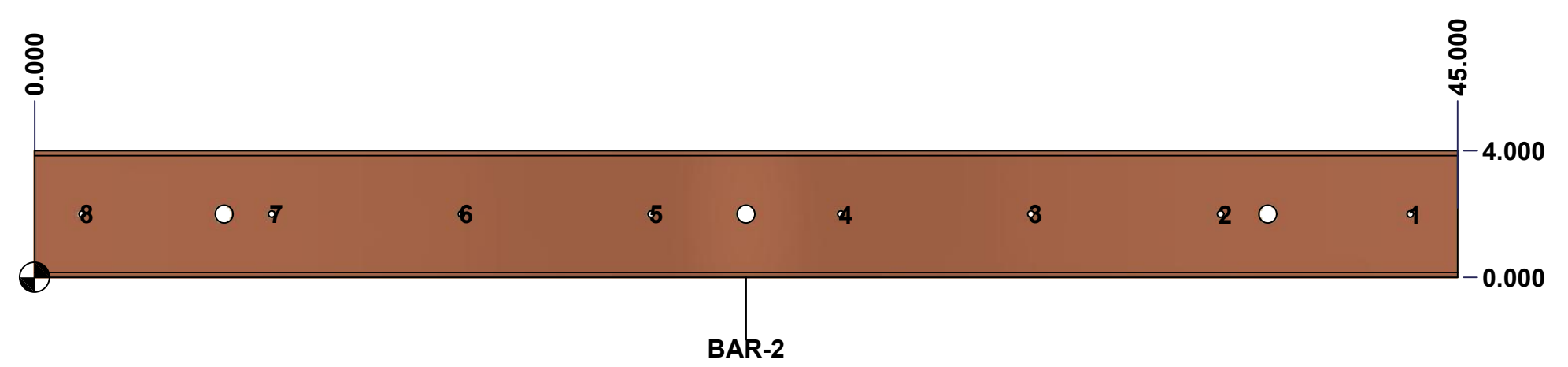

	Description	Status
	Rounded Edge Copper Bar 5/16" x 4"	(NULL)
	Part Number Numéro Pièce	Rev.
	1412BTCU051204DTBAR2-P	8
	0	15

This drawing is confidential and must not be reproduced or used without the consent of Eurobox

Ce dessin est confidentiel et ne doit pas être reproduit ou utilisé sans le consentement de Eurobox

STANDARD FEATURES ARE NOT LISTED IN THIS HOLE TABLE

HOLE TABLE - FRONT VIEW (CUSTOM FEATURE ONLY)

CUT-OUT	XDIM	YDIM	DESCRIPTION
1	43.500	2.000	RND Ø0.201 THREAD 1/4-20 UNC
2	37.500	2.000	RND Ø0.201 THREAD 1/4-20 UNC
3	31.500	2.000	RND Ø0.201 THREAD 1/4-20 UNC
4	25.500	2.000	RND Ø0.201 THREAD 1/4-20 UNC
5	19.500	2.000	RND Ø0.201 THREAD 1/4-20 UNC
6	13.500	2.000	RND Ø0.201 THREAD 1/4-20 UNC
7	7.500	2.000	RND Ø0.201 THREAD 1/4-20 UNC
8	1.500	2.000	RND Ø0.201 THREAD 1/4-20 UNC

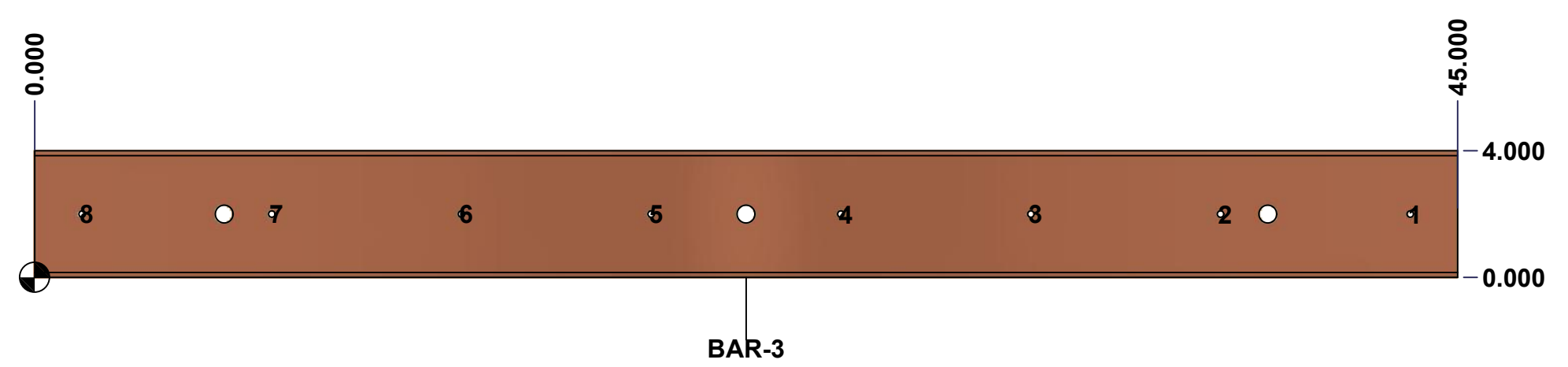

	Description	Status
	Rounded Edge Copper Bar 5/16" x 4"	(NULL)
	Part Number Numéro Pièce	Rev.
	1412BTCU051204DTBAR3-P	9
	0	15

This drawing is confidential and must not be reproduced or used without the consent of Eurobox

Ce dessin est confidentiel et ne doit pas être reproduit ou utilisé sans le consentement de Eurobox

STANDARD FEATURES ARE NOT LISTED IN THIS HOLE TABLE

HOLE TABLE - FRONT VIEW (CUSTOM FEATURE ONLY)

CUT-OUT	XDIM	YDIM	DESCRIPTION
1	43.500	2.000	RND Ø0.201 THREAD 1/4-20 UNC
2	37.500	2.000	RND Ø0.201 THREAD 1/4-20 UNC
3	31.500	2.000	RND Ø0.201 THREAD 1/4-20 UNC
4	25.500	2.000	RND Ø0.201 THREAD 1/4-20 UNC
5	19.500	2.000	RND Ø0.201 THREAD 1/4-20 UNC
6	13.500	2.000	RND Ø0.201 THREAD 1/4-20 UNC
7	7.500	2.000	RND Ø0.201 THREAD 1/4-20 UNC
8	1.500	2.000	RND Ø0.201 THREAD 1/4-20 UNC

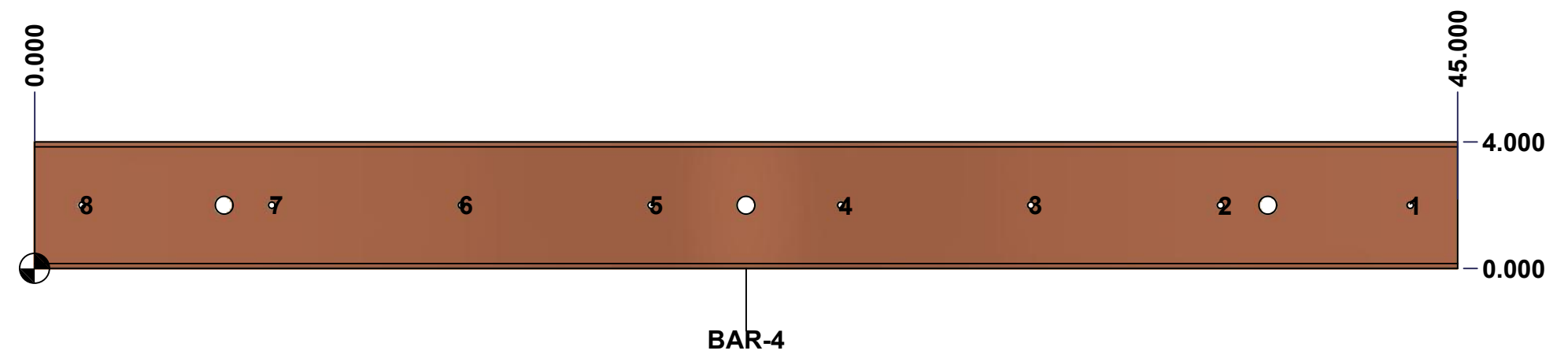

	Description	Status	
	Rounded Edge Copper Bar 5/16" x 4"	(NULL)	
	Part Number Numéro Pièce	Rev.	
	1412BTCU051204DTBAR4-P	0	10 15

This drawing is confidential and must not be reproduced or used without the consent of EXM

Ce dessin est confidentiel et ne doit pas être reproduit ou utilisé sans le consentement de EXM



TOP

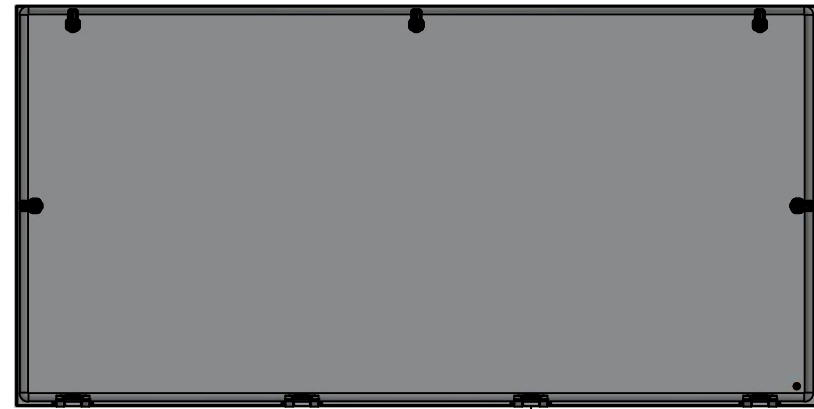

BACK

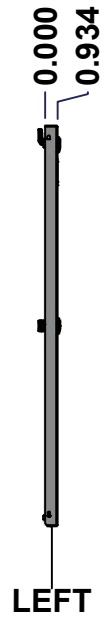

LEFT

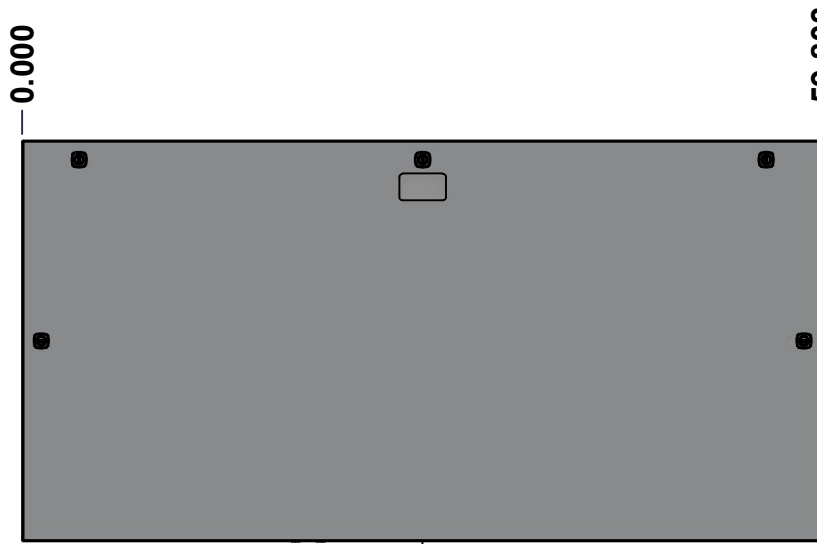

FRONT

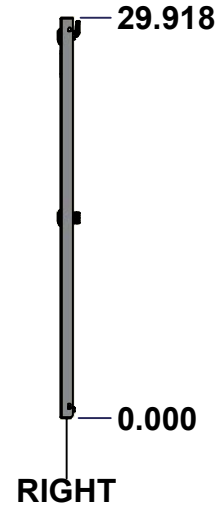



RIGHT

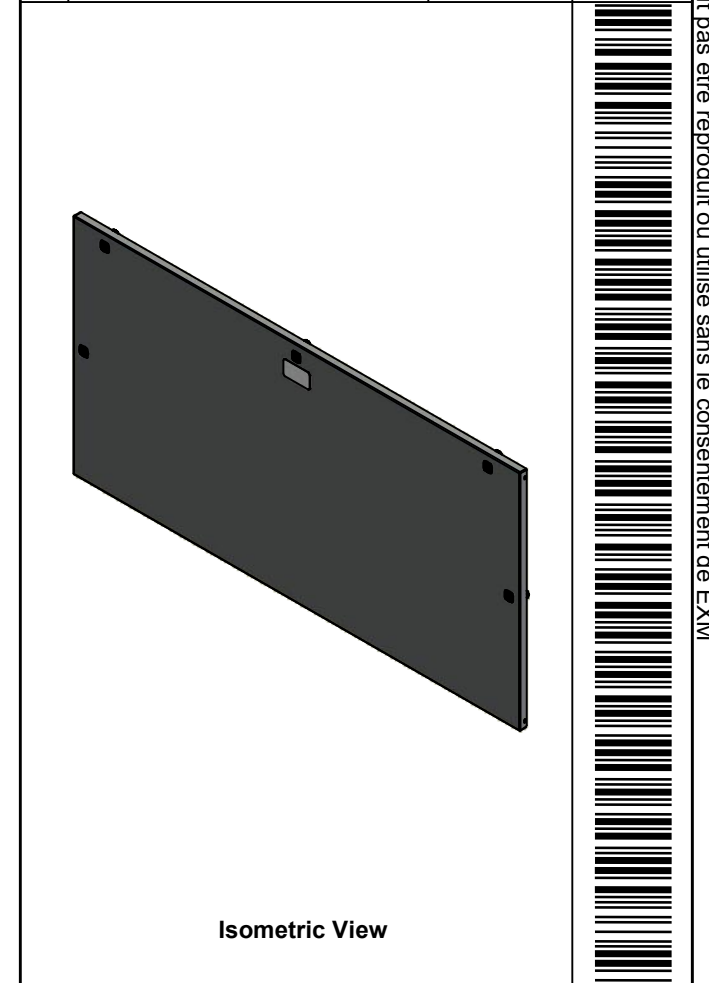

BOTTOM

No.	Revisions	Date	By/Par

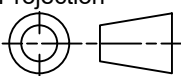

 Tél: (450) 979-4373 Fax: (450) 979-4626 www.exmweb.com		Flatness Aplatissement Max 3.0mm Projection 
Customer Client	Date	
Drawn By Dessiné Par	BoxCad: BoxCad	Date 2022-10-21
Material Matière	14 Ga Cold Rolled A1008 CS Type B (1.7mm)	
Color Couleur	Asa-61 Grey	Finish Fini Smooth
Description 1412BTCU 30" x 60" Cover		Detail Rev.
Part Number Numéro Pièce	Rev. 0	11 / 15

SEE BILL OF MATERIAL ON LAST PAGE

1412BTCU051204DTC

This drawing is confidential and must not be reproduced or used without the consent of Eurobox

Ce dessin est confidentiel et ne doit pas être reproduit ou utilisé sans le consentement de Eurobox

STANDARD FEATURES ARE NOT LISTED IN THIS HOLE TABLE

HOLE TABLE - FRONT VIEW (CUSTOM FEATURE ONLY)

CUT-OUT	XDIM	YDIM	DESCRIPTION
1	1.500	1.486	GND STUD M6 x 16mm (Inside)
2	1.424	14.959	LOCK 880 SCQ4-SL @ 180.0°
3	55.553	28.494	LOCK 880 SCQ4-SL @ 90.0°
4	29.902	28.494	LOCK 880 SCQ4-SL @ 90.0°
5	4.250	28.494	LOCK 880 SCQ4-SL @ 90.0°
6	58.379	14.959	LOCK 880 SCQ4-SL @ 0.0°

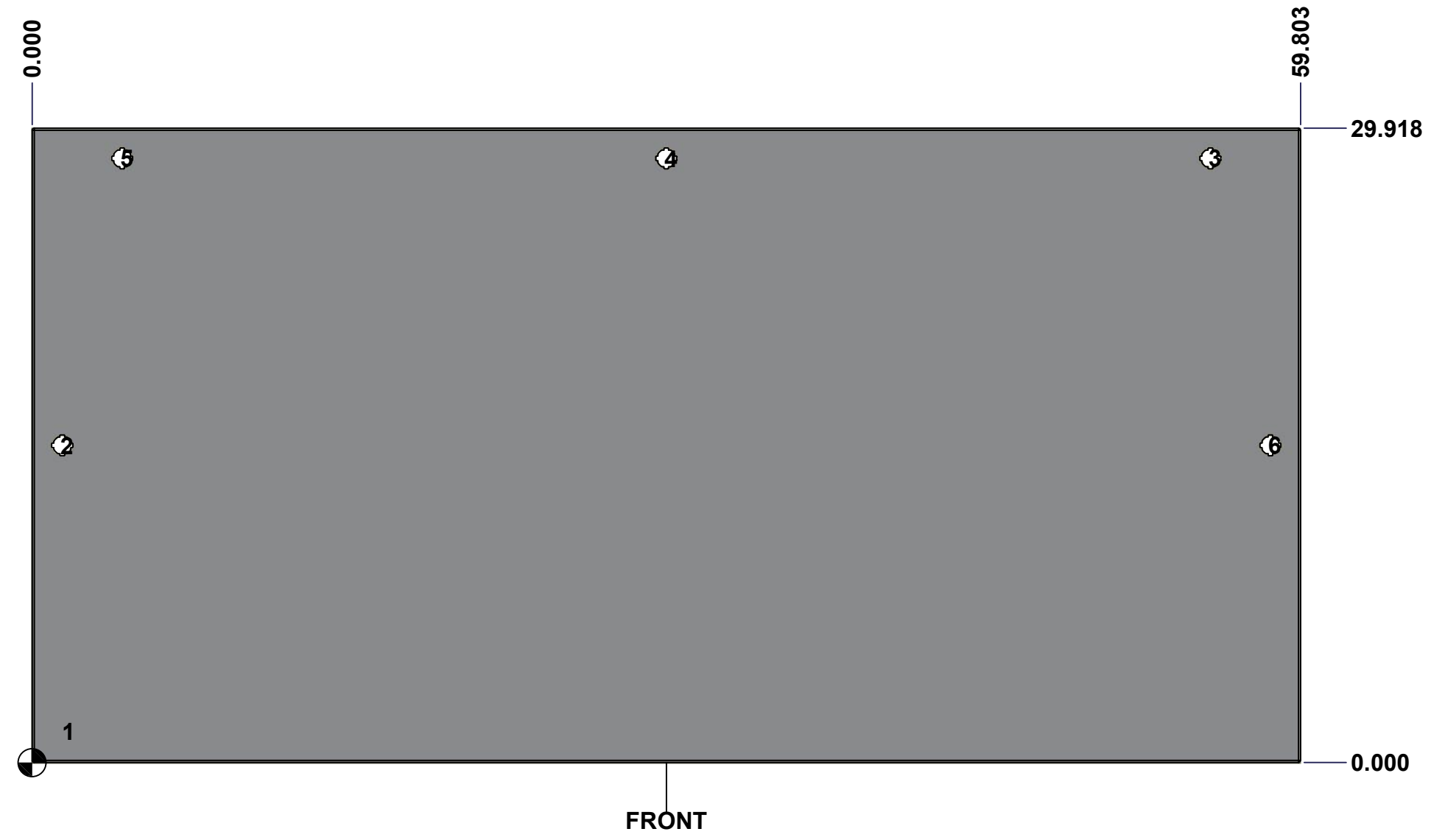



	Description	Status	
	1412BTCU 30" x 60" Cover	(NULL)	
	Part Number Numéro Pièce	Rev.	12
	1412BTCU051204DTC	0	15

This drawing is confidential and must not be reproduced or used without the consent of EXM

Ce dessin est confidentiel et ne doit pas être reproduit ou utilisé sans le consentement de EXM

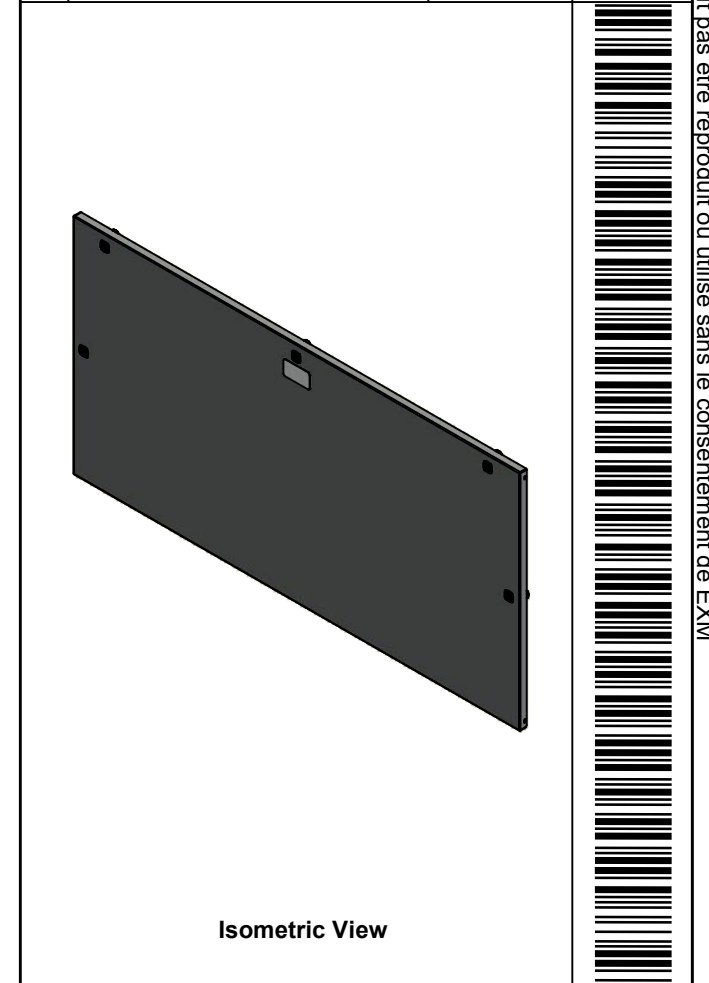
No.	Revisions	Date	By/Par

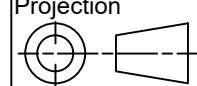

 Tél: (450) 979-4373 Fax: (450) 979-4626 www.exmweb.com		Flatness Aplatissement Max 3.0mm Projection 
Customer Client	Date	
Drawn By Dessiné Par	BoxCad: BoxCad	Date 2022-10-21
Material Matière	14 Ga Cold Rolled A1008 CS Type B (1.7mm)	
Color Couleur	Asa-61 Grey	Finish Fini Smooth
Description		Detail Rev.
1412BTCU 30" x 60" Cover		
Part Number Numéro Pièce	Rev. 0	13 / 15
1412BTCU051204DTC		

Qty	Part Name	Rev	Description
1	1412BTCU051204DTG	0	1412BTCU 30" x 60" Cover Gasket
1	STK-P-02400S	0	Powder Paint (Asa-61 Grey / Smooth)
4	STK-K-09800	10	5412 ES Hinge with 2 Captive Hinge Pins
1	STK-Q-16080	0	Ground Stud M6 x 16mm
1	STK-S-00100	0	3.5" x 2" Silver Milar Flexcon Sticker
1	1412BTCU051204DTC-P	0	1412BTCU 30" x 60" Cover Part
5	880 SCQ4-SL	6	5412 ES 1/4 Turn Lock
Parts List			

This drawing is confidential and must not be reproduced or used without the consent of EXM

Ce dessin est confidentiel et ne doit pas être reproduit ou utilisé sans le consentement de EXM

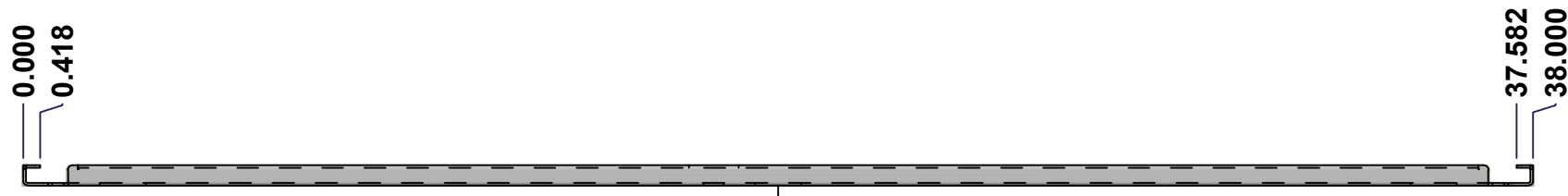

TOP

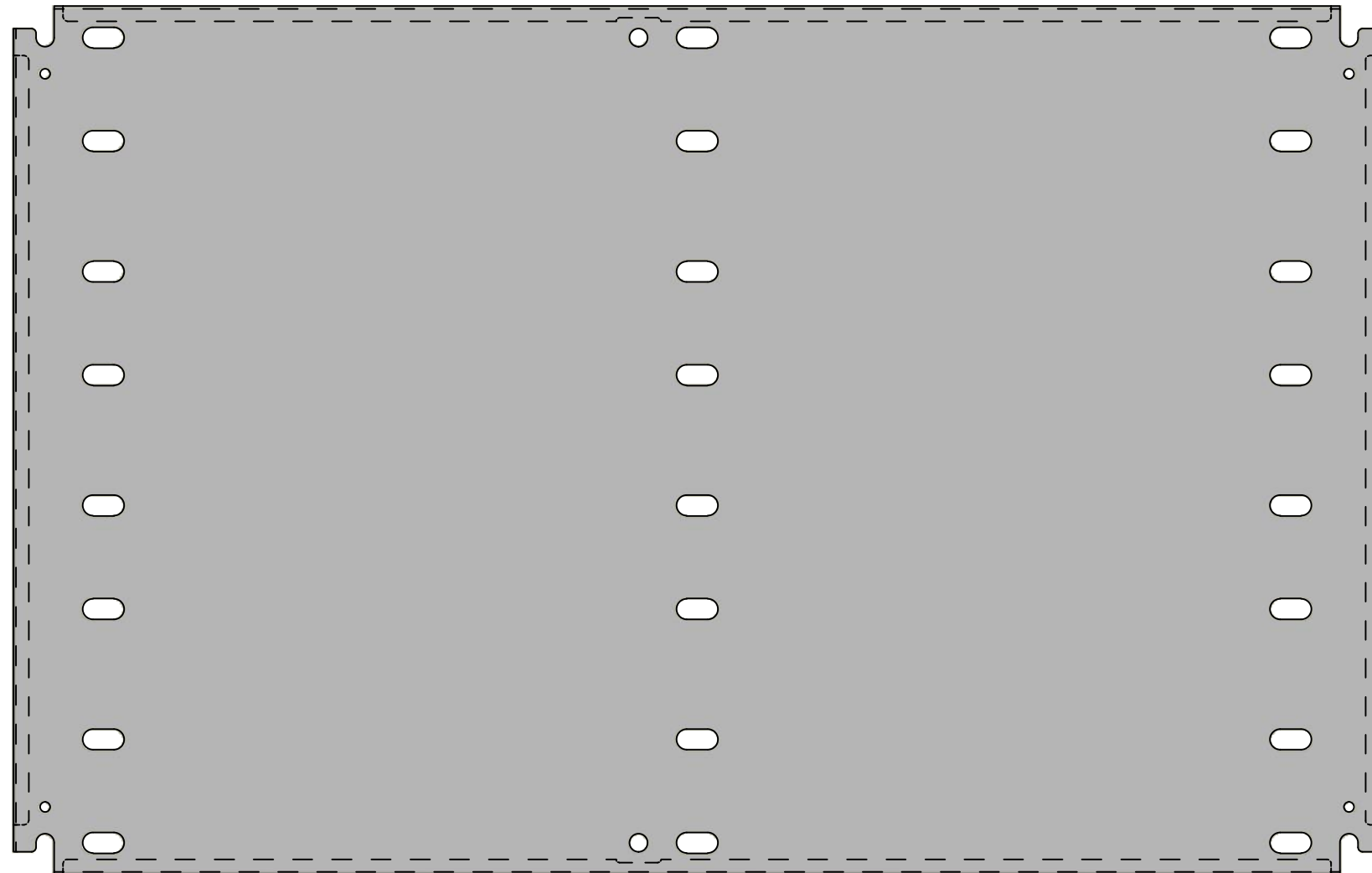

FRONT

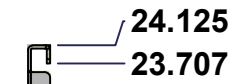

RIGHT

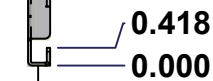

No.	Revisions	Date	By/Par

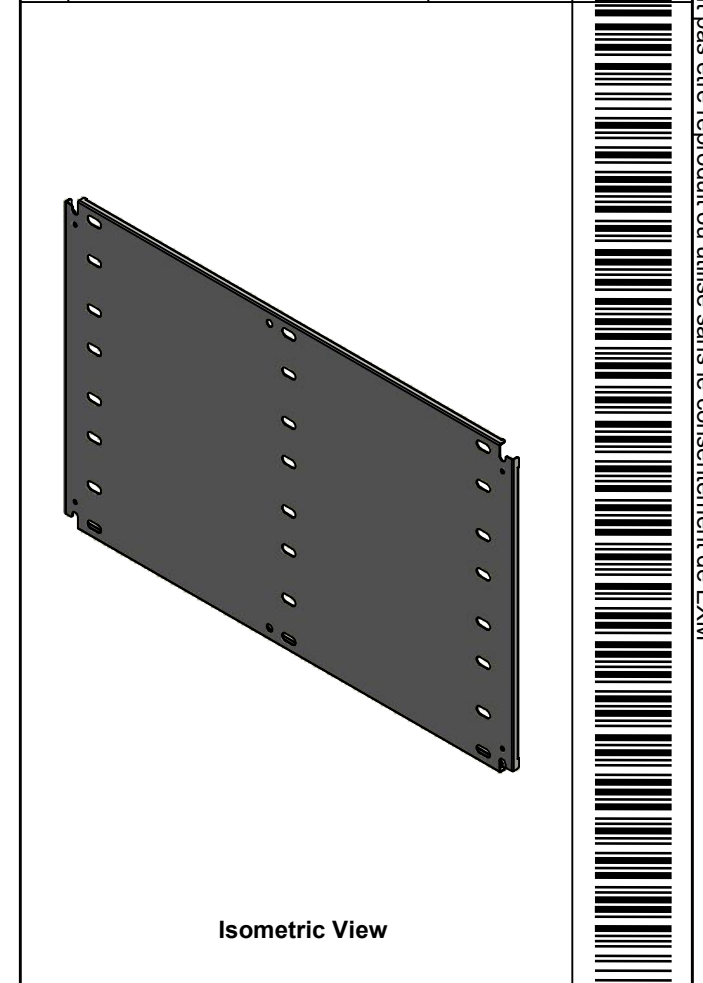

Isometric View

		Flatness / Aplatissement Max 3.0mm Projection	
Customer / Client		Date	
Drawn By / Dessiné Par: BoxCad: BoxCad		Date: 2022-10-21	
Material / Matière: 14 Ga Cold Rolled A1008 CS Type B (1.7mm)			
Color / Couleur: White RAL9003		Finish / Fini: Smooth	
Description: 1412BTCU 24.125" x 38" Inner Panel			Detail Rev.
Part Number / Numéro Pièce: 1412BTCU051204DTIP1		Rev.: 0	14 / 15

SEE BILL OF MATERIAL ON LAST PAGE

This drawing is confidential and must not be reproduced or used without the consent of EXM

Ce dessin est confidentiel et ne doit pas être reproduit ou utilisé sans le consentement de EXM

No.	Revisions	Date	By/Par

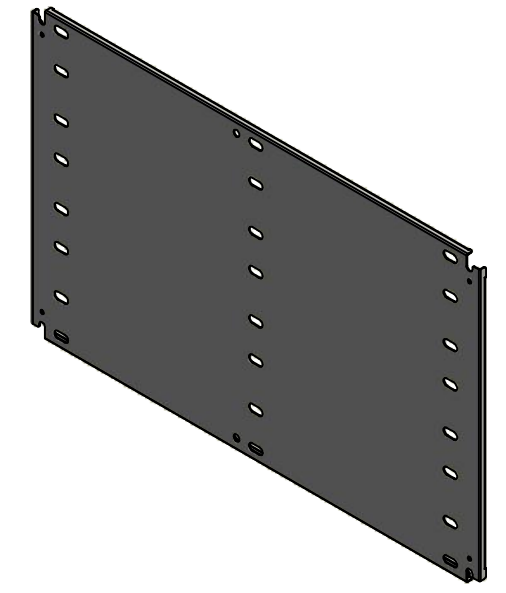

Isometric View

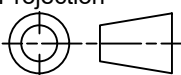

 Tél: (450) 979-4373 Fax: (450) 979-4626 www.exmweb.com		Flatness Aplatissement Max 3.0mm Projection 
Customer Client	Date	
Drawn By Dessiné Par	BoxCad: BoxCad	Date 2022-10-21
Material Matière	14 Ga Cold Rolled A1008 CS Type B (1.7mm)	
Color Couleur	White RAL9003	Finish Fini Smooth
Description		Detail Rev.
1412BTCU 24.125" x 38" Inner Panel		
Part Number Numéro Pièce	Rev.	15
1412BTCU051204DTIP1	0	15

Qty	Part Number	Rev	Description
1	STK-P-02401S	0	Powder Paint (White / Smooth)
1	1412BTCU051204DTIP1-P	0	1412BTCU 24.125" x 60" Inner Panel Part
Parts List			