

This drawing is confidential and must not be reproduced or used without the consent of EXM

Ce dessin est confidentiel et ne doit pas être reproduit ou utilisé sans le consentement de EXM



TOP



BACK

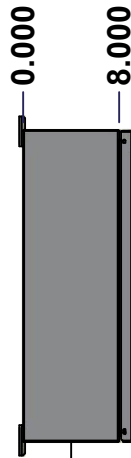

LEFT

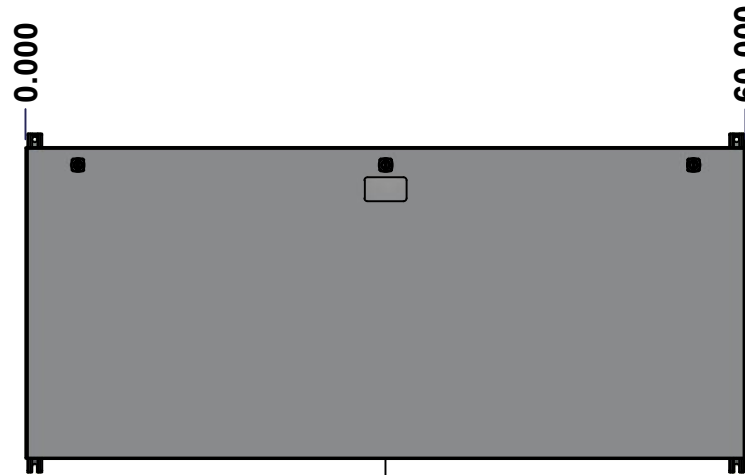

FRONT

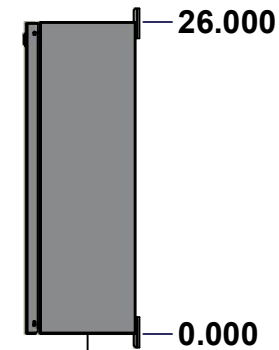

RIGHT



BOTTOM

No.	Revisions	Date	By/Par

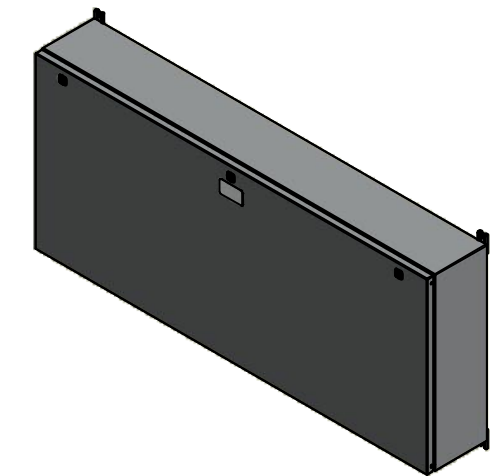

Isometric View



Tél: (450) 979-4373
 Fax: (450) 979-4626
www.exmweb.com

Flatness
Aplatissement

Max 3.0mm

Projection



Customer Client	Date
Drawn By / Dessiné Par: BoxCad: BoxCad	Date: 2022-10-18
Material / Matière: 14 Ga Cold Rolled A1008 CS Type B (1.7mm)	

Color / Couleur: Asa-61 Grey	Finish / Fini: Smooth
------------------------------	-----------------------

Description: 1412BTCU 225A - 5Wires x 60" Assembly	Detail Rev.
--	-------------

Part Number / Numéro Pièce: 1412BTCU05205DT	Rev. 0	1
---	--------	---

SEE BILL OF MATERIAL ON LAST PAGE

This drawing is confidential and must not be reproduced or used without the consent of Eurobox

Ce dessin est confidentiel et ne doit pas être reproduit ou utilisé sans le consentement de Eurobox

STANDARD FEATURES ARE NOT LISTED IN THIS HOLE TABLE

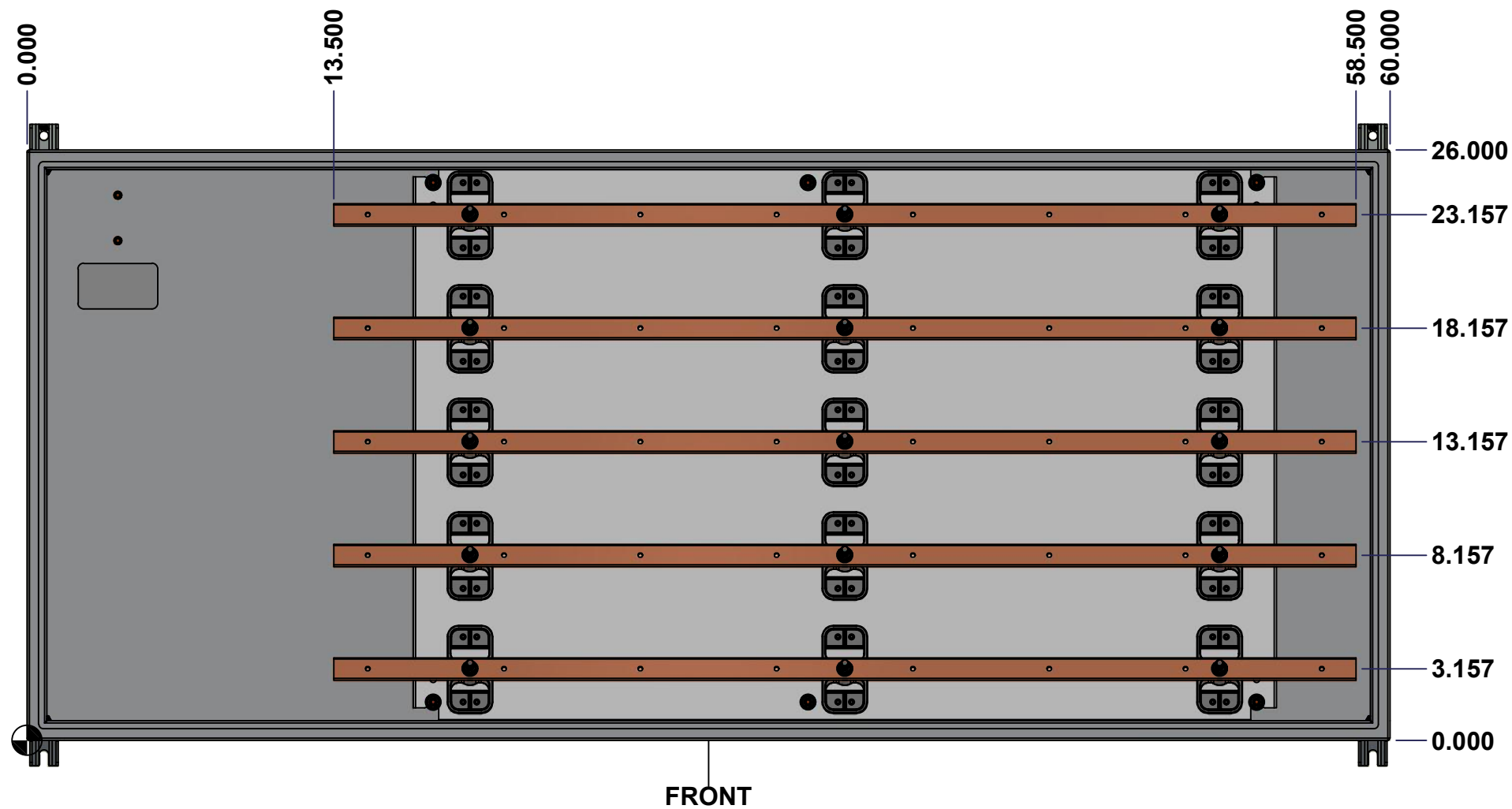

	Description	Status	
	1412BTCU 225A - 5Wires x 60" Assembly	(NULL)	
	Part Number	Rev.	2
	Numéro Pièce	0	16
	1412BTCU05205DT		

This drawing is confidential and must not be reproduced or used without the consent of EXM

Ce dessin est confidentiel et ne doit pas être reproduit ou utilisé sans le consentement de EXM

NOTE	
ITEM	DESCRIPTION
1	NEMA 4/12 Enclosure
2	C/W Standard ground studs on box and cover
3	W/O Standard door stiffener
4	C/W Special inner panel (Sold separately)
5	C/W Standard inner panel mounting studs

No.	Revisions	Date	By/Par

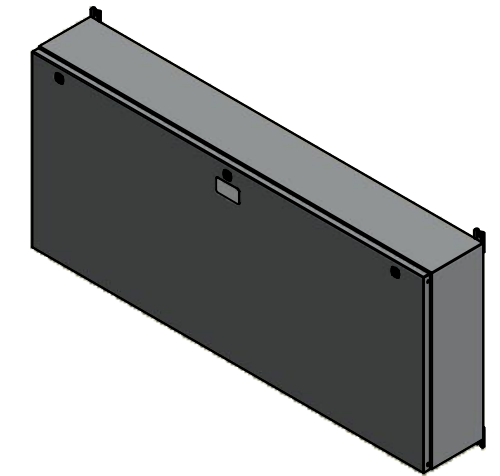

Isometric View



1	885 ESMF1	0	885 ESMF1 Mounting Feet Kit
1	1412BTCU05205DTBAR4-P	0	Rounded Edge Copper Bar 1/8" x 1"
1	1412BTCU05205DTBAR1-P	0	Rounded Edge Copper Bar 1/8" x 1"
1	1412BTCU05205DTBAR2-P	0	Rounded Edge Copper Bar 1/8" x 1"
1	1412BTCU05205DTBAR3-P	0	Rounded Edge Copper Bar 1/8" x 1"
1	1412BTCU05205DTBAR5-P	0	Rounded Edge Copper Bar 1/8" x 1"
1	1412BTCU05205DTIP1	0	1412BTCU 24.625" x 38" Inner Panel
15	STK-A-67400	0	Buss Bar Insulator Kit
1	STK-K-01800	5	5412 ES Accessory Kit
4	STK-Q-04050-07	7	M6 x 7mm Hexagon Socket Head Machine Screw with Nyseal
21	STK-Q-07310	2	Flange Lock Nut M8
6	STK-Q-07610	8	M8 Plastic Spacer 22.2mm
1	1412BTCU05205DTB	0	1412BTCU 26" x 60" x 8" Body
1	1412BTCU05205DTC	0	1412BTCU 26" x 60" Cover
Qty	Part Number	Rev	Description
Parts List			

PACKING		
ITEM	QTY	DESCRIPTION
Cardboard sleeve	2	Top and Bottom
Cardboard strip	2	Between back of enclosure and inner panel
Plastic bag	1	To protect cover surface and inside gasket
Cardboard corner	4	To reinforced for the plastic strap tightening
Plastic strap - Black	2	To Squeeze 2 cardboard sleeve together
Packaging label	3	White label with PN
Plastic strap- Green	2	To secure the enclosure to the wood pallet
Wood Pallet	1	2" deeper and 3" larger than enclosure size

	Tél: (450) 979-4373 Fax: (450) 979-4626 www.exmweb.com	Flatness Aplatissement Max 3.0mm Projection
	Customer Client Drawn By Dessiné Par Material Matière 14 Ga Cold Rolled A1008 CS Type B (1.7mm)	Date Date 2022-10-18
Color Couleur Asa-61 Grey	Finish Fini Smooth	Description 1412BTCU 225A - 5Wires x 60" Assembly
Part Number Numéro Pièce 1412BTCU05205DT	Rev. 0	Detail Rev. 3 16

This drawing is confidential and must not be reproduced or used without the consent of EXM

Ce dessin est confidentiel et ne doit pas être reproduit ou utilisé sans le consentement de EXM



TOP



BACK

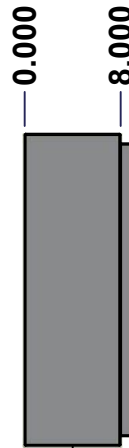

LEFT

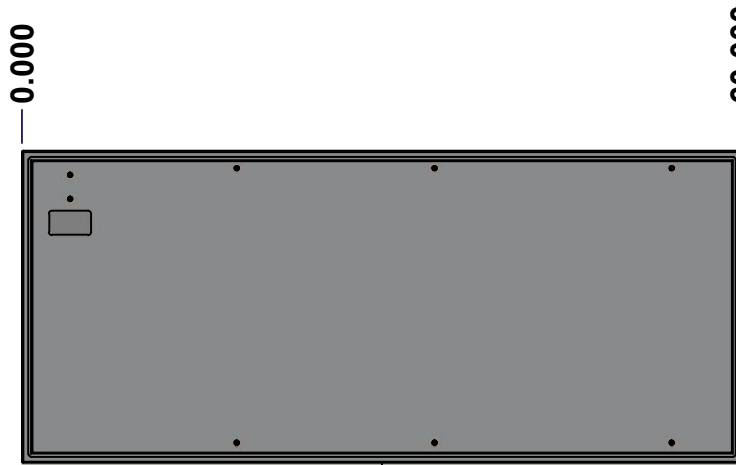

FRONT

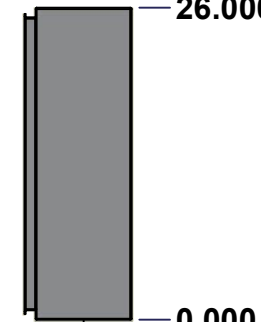



RIGHT

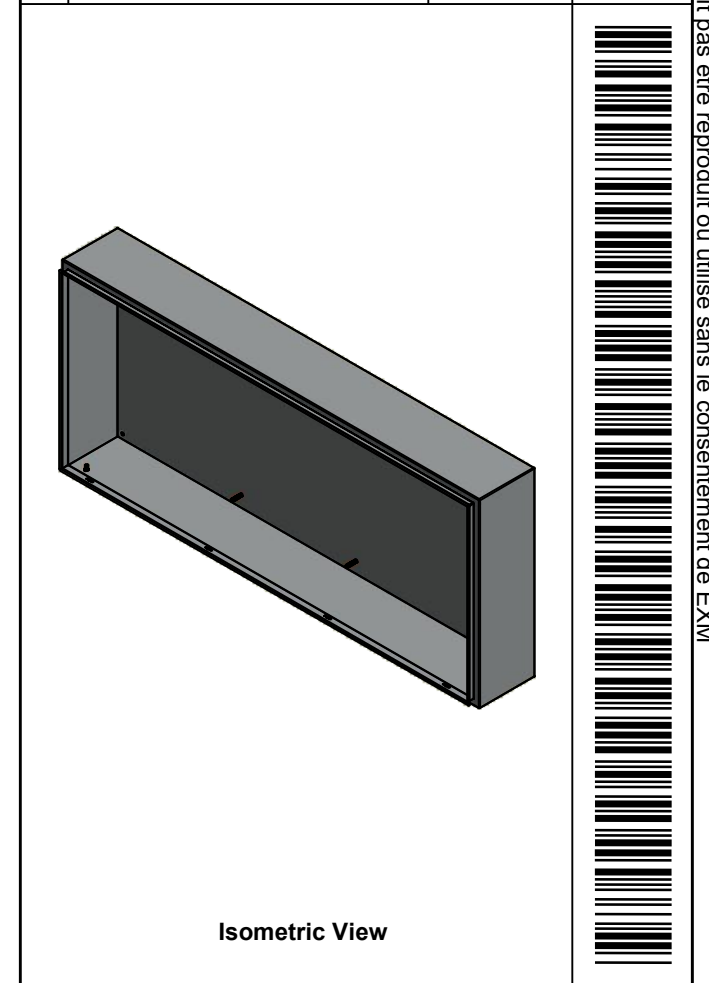

BOTTOM

No.	Revisions	Date	By/Par

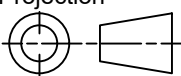

 Tél: (450) 979-4373 Fax: (450) 979-4626 www.exmweb.com		Flatness Aplatissement Max 3.0mm Projection 
Customer Client	Date	
Drawn By Dessiné Par	BoxCad: BoxCad	Date 2022-10-18
Material Matière	14 Ga Cold Rolled A1008 CS Type B (1.7mm)	
Color Couleur	Asa-61 Grey	Finish Fini Smooth
Description	Detail Rev.	
1412BTCU 26" x 60" x 8" Body		
Part Number Numéro Pièce	Rev.	4
1412BTCU05205DTB	0	16

SEE BILL OF MATERIAL ON LAST PAGE

This drawing is confidential and must not be reproduced or used without the consent of Eurobox

Ce dessin est confidentiel et ne doit pas être reproduit ou utilisé sans le consentement de Eurobox

STANDARD FEATURES ARE NOT LISTED IN THIS HOLE TABLE

HOLE TABLE - BACK VIEW (CUSTOM FEATURE ONLY)

CUT-OUT	XDIM	YDIM	DESCRIPTION
1	56.000	24.000	GND STUD M8 x 35mm (Inside)
2	56.000	22.000	GND STUD M8 x 35mm (Inside)
3	5.875	24.563	IP STUD M8 x 35mm (Inside)
4	42.125	24.563	IP STUD M8 x 35mm (Inside)
5	5.875	1.688	IP STUD M8 x 35mm (Inside)
6	42.125	1.688	IP STUD M8 x 35mm (Inside)
7	25.625	24.563	IP STUD M8 x 35mm (Inside)
8	25.625	1.688	IP STUD M8 x 35mm (Inside)

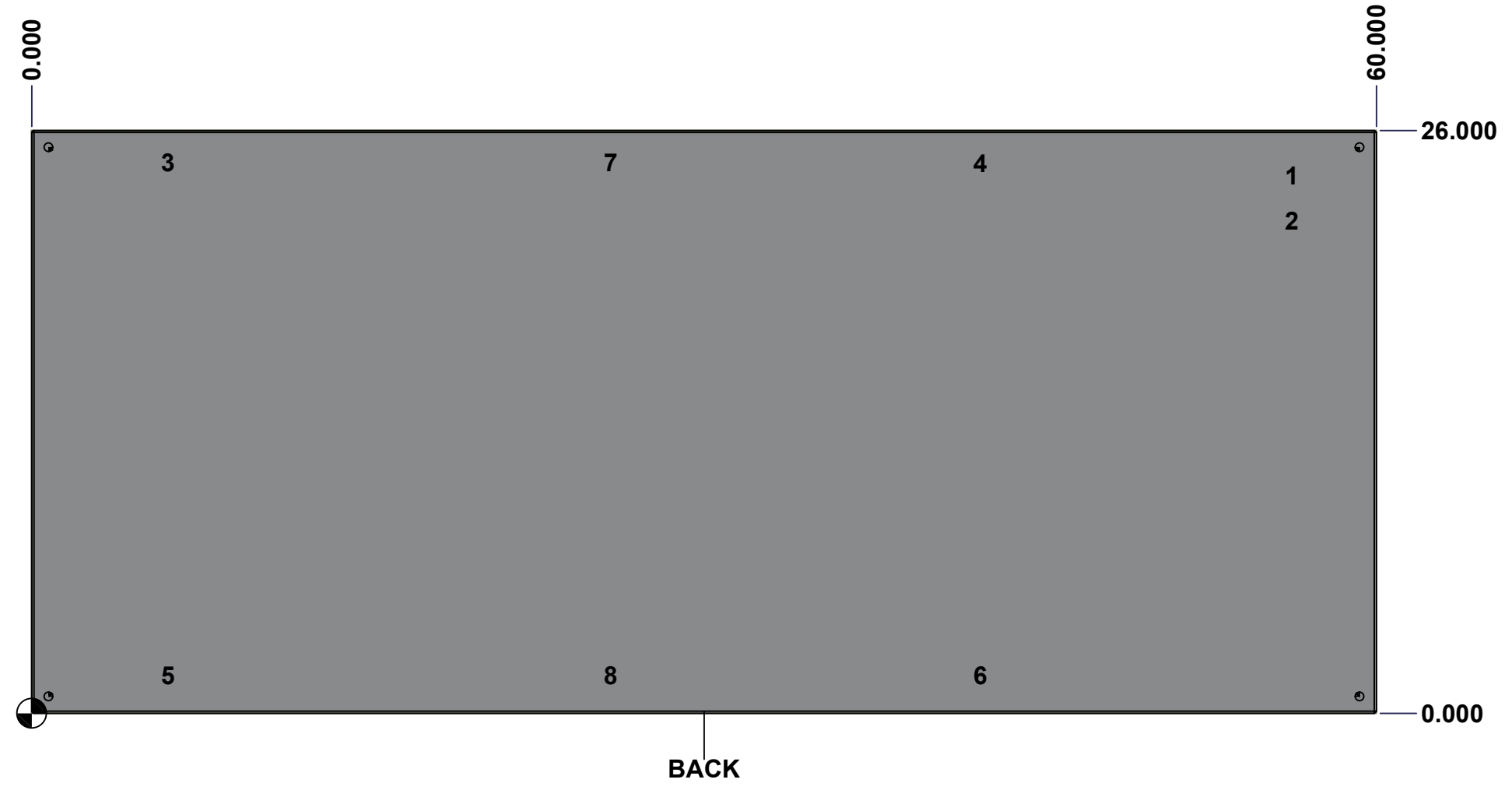

	Description	Status
	1412BTCU 26" x 60" x 8" Body	(NULL)
	Part Number Numéro Pièce	Rev.
	1412BTCU05205DTB	0 / 5
		16

This drawing is confidential and must not be reproduced or used without the consent of EXM

Ce dessin est confidentiel et ne doit pas être reproduit ou utilisé sans le consentement de EXM

No.	Revisions	Date	By/Par

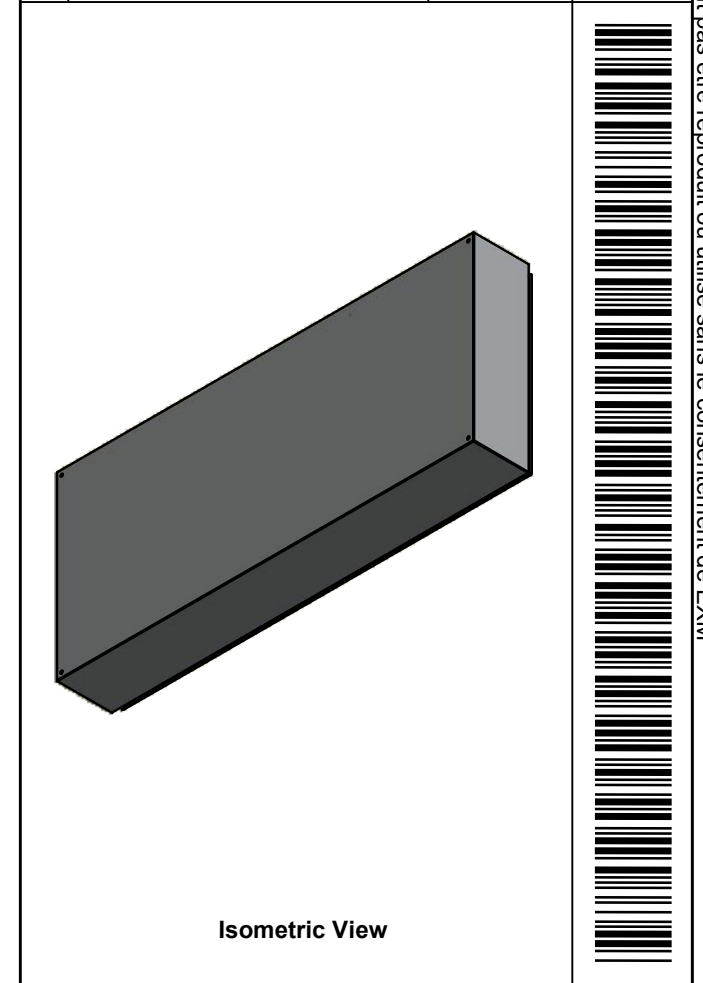

Tél: (450) 979-4373 Fax: (450) 979-4626 www.exmweb.com		Flatness Aplatissement Max 3.0mm Projection
Customer Client	Date	
Drawn By Dessiné Par	BoxCad: BoxCad	Date 2022-10-18
Material Matière	14 Ga Cold Rolled A1008 CS Type B (1.7mm)	
Color Couleur	Asa-61 Grey	Finish Fini Smooth
Description		Detail Rev.
1412BTCU 26" x 60" x 8" Body		
Part Number Numéro Pièce	Rev. 0	6 / 16

Qty	Part Number	Rev	Description
1	STK-P-02400S	0	Powder Paint (Asa-61 Grey / Smooth)
8	STK-Q-16005	1	Stud M8 x 35 (No Paint Cap Required)
1	STK-Q-16080	0	Ground Stud M6 x 16mm
1	STK-S-00100	0	3.5" x 2" Silver Milar Flexcon Sticker
1	1412BTCU05205DTB-P	0	1412BTCU 26" x 60" x 8" Body Part
Parts List			

This drawing is confidential and must not be reproduced or used without the consent of Eurobox

Ce dessin est confidentiel et ne doit pas être reproduit ou utilisé sans le consentement de Eurobox

STANDARD FEATURES ARE NOT LISTED IN THIS HOLE TABLE

HOLE TABLE - FRONT VIEW (CUSTOM FEATURE ONLY)

CUT-OUT	XDIM	YDIM	DESCRIPTION
1	43.500	0.500	RND Ø0.201 THREAD 1/4-20 UNC
2	37.500	0.500	RND Ø0.201 THREAD 1/4-20 UNC
3	31.500	0.500	RND Ø0.201 THREAD 1/4-20 UNC
4	25.500	0.500	RND Ø0.201 THREAD 1/4-20 UNC
5	19.500	0.500	RND Ø0.201 THREAD 1/4-20 UNC
6	13.500	0.500	RND Ø0.201 THREAD 1/4-20 UNC
7	7.500	0.500	RND Ø0.201 THREAD 1/4-20 UNC
8	1.500	0.500	RND Ø0.201 THREAD 1/4-20 UNC

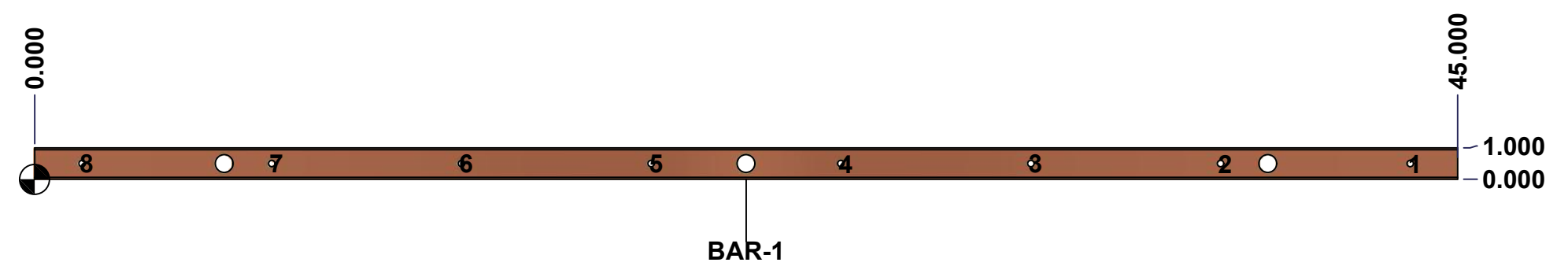

	Description	Status	
	Rounded Edge Copper Bar 1/8" x 1"	(NULL)	
	Part Number Numéro Pièce	Rev.	7
	1412BTCU05205DTBAR1-P	0	16

This drawing is confidential and must not be reproduced or used without the consent of Eurobox

Ce dessin est confidentiel et ne doit pas être reproduit ou utilisé sans le consentement de Eurobox

STANDARD FEATURES ARE NOT LISTED IN THIS HOLE TABLE

HOLE TABLE - FRONT VIEW (CUSTOM FEATURE ONLY)

CUT-OUT	XDIM	YDIM	DESCRIPTION
1	43.500	0.500	RND Ø0.201 THREAD 1/4-20 UNC
2	37.500	0.500	RND Ø0.201 THREAD 1/4-20 UNC
3	31.500	0.500	RND Ø0.201 THREAD 1/4-20 UNC
4	25.500	0.500	RND Ø0.201 THREAD 1/4-20 UNC
5	19.500	0.500	RND Ø0.201 THREAD 1/4-20 UNC
6	13.500	0.500	RND Ø0.201 THREAD 1/4-20 UNC
7	7.500	0.500	RND Ø0.201 THREAD 1/4-20 UNC
8	1.500	0.500	RND Ø0.201 THREAD 1/4-20 UNC

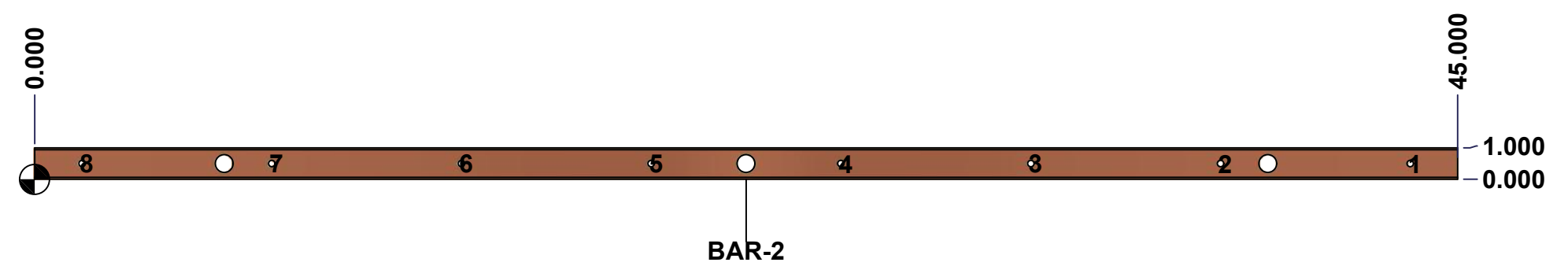

	Description	Status
	Rounded Edge Copper Bar 1/8" x 1"	(NULL)
	Part Number Numéro Pièce	Rev.
	1412BTCU05205DTBAR2-P	0
		8
		16

This drawing is confidential and must not be reproduced or used without the consent of Eurobox

Ce dessin est confidentiel et ne doit pas être reproduit ou utilisé sans le consentement de Eurobox

STANDARD FEATURES ARE NOT LISTED IN THIS HOLE TABLE			
HOLE TABLE - FRONT VIEW (CUSTOM FEATURE ONLY)			
CUT-OUT	XDIM	YDIM	DESCRIPTION
1	43.500	0.500	RND Ø0.201 THREAD 1/4-20 UNC
2	37.500	0.500	RND Ø0.201 THREAD 1/4-20 UNC
3	31.500	0.500	RND Ø0.201 THREAD 1/4-20 UNC
4	25.500	0.500	RND Ø0.201 THREAD 1/4-20 UNC
5	19.500	0.500	RND Ø0.201 THREAD 1/4-20 UNC
6	13.500	0.500	RND Ø0.201 THREAD 1/4-20 UNC
7	7.500	0.500	RND Ø0.201 THREAD 1/4-20 UNC
8	1.500	0.500	RND Ø0.201 THREAD 1/4-20 UNC

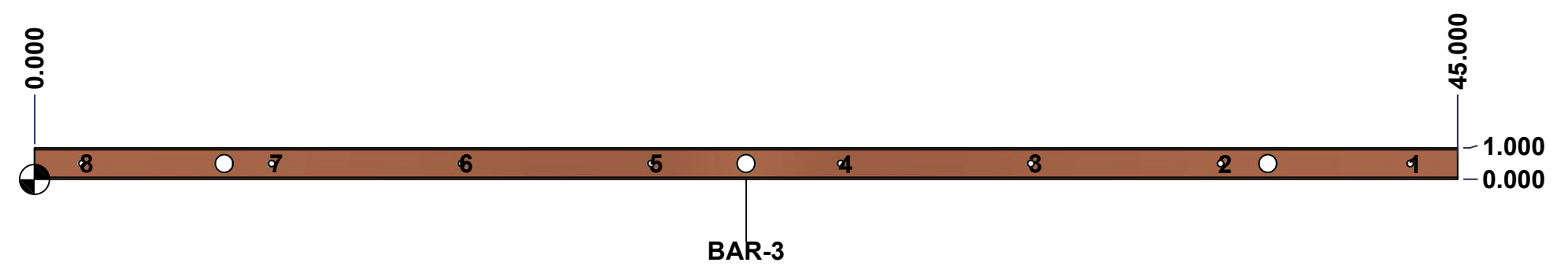

	Description	Status
	Rounded Edge Copper Bar 1/8" x 1"	(NULL)
	Part Number Numéro Pièce	Rev.
	1412BTCU05205DTBAR3-P	0
		9
		16

This drawing is confidential and must not be reproduced or used without the consent of Eurobox

Ce dessin est confidentiel et ne doit pas être reproduit ou utilisé sans le consentement de Eurobox

STANDARD FEATURES ARE NOT LISTED IN THIS HOLE TABLE

HOLE TABLE - FRONT VIEW (CUSTOM FEATURE ONLY)

CUT-OUT	XDIM	YDIM	DESCRIPTION
1	43.500	0.500	RND Ø0.201 THREAD 1/4-20 UNC
2	37.500	0.500	RND Ø0.201 THREAD 1/4-20 UNC
3	31.500	0.500	RND Ø0.201 THREAD 1/4-20 UNC
4	25.500	0.500	RND Ø0.201 THREAD 1/4-20 UNC
5	19.500	0.500	RND Ø0.201 THREAD 1/4-20 UNC
6	13.500	0.500	RND Ø0.201 THREAD 1/4-20 UNC
7	7.500	0.500	RND Ø0.201 THREAD 1/4-20 UNC
8	1.500	0.500	RND Ø0.201 THREAD 1/4-20 UNC

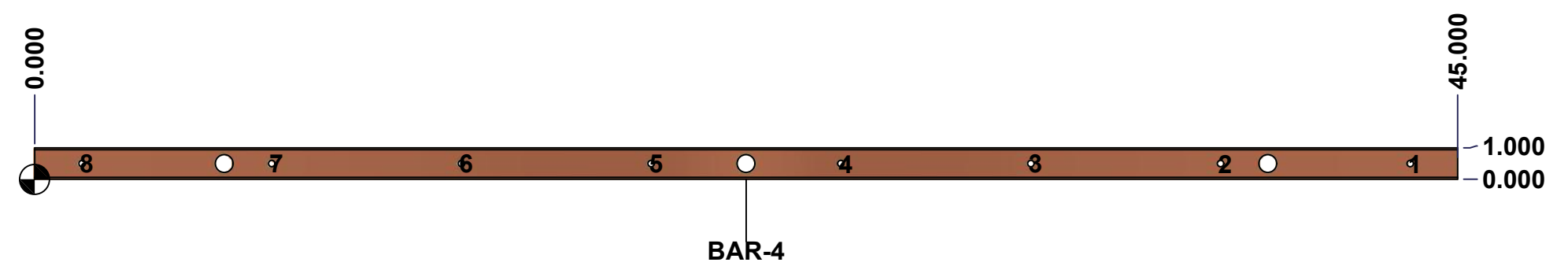

	Description	Status	
	Rounded Edge Copper Bar 1/8" x 1"	(NULL)	
	Part Number Numéro Pièce	Rev.	10
	1412BTCU05205DTBAR4-P	0	16

This drawing is confidential and must not be reproduced or used without the consent of Eurobox

Ce dessin est confidentiel et ne doit pas être reproduit ou utilisé sans le consentement de Eurobox

STANDARD FEATURES ARE NOT LISTED IN THIS HOLE TABLE

HOLE TABLE - FRONT VIEW (CUSTOM FEATURE ONLY)

CUT-OUT	XDIM	YDIM	DESCRIPTION
1	43.500	0.500	RND Ø0.201 THREAD 1/4-20 UNC
2	37.500	0.500	RND Ø0.201 THREAD 1/4-20 UNC
3	31.500	0.500	RND Ø0.201 THREAD 1/4-20 UNC
4	25.500	0.500	RND Ø0.201 THREAD 1/4-20 UNC
5	19.500	0.500	RND Ø0.201 THREAD 1/4-20 UNC
6	13.500	0.500	RND Ø0.201 THREAD 1/4-20 UNC
7	7.500	0.500	RND Ø0.201 THREAD 1/4-20 UNC
8	1.500	0.500	RND Ø0.201 THREAD 1/4-20 UNC

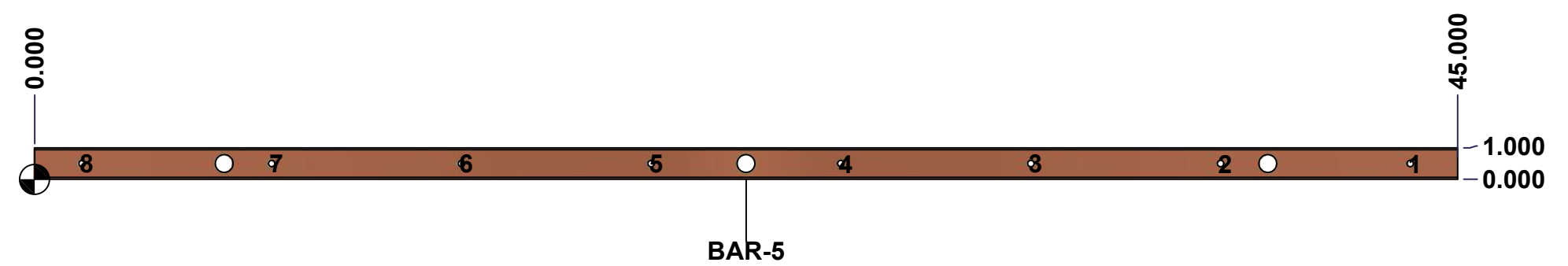

	Description	Status	
	Rounded Edge Copper Bar 1/8" x 1"	(NULL)	
	Part Number Numéro Pièce	Rev.	11
	1412BTCU05205DTBAR5-P	0	16

This drawing is confidential and must not be reproduced or used without the consent of EXM

Ce dessin est confidentiel et ne doit pas être reproduit ou utilisé sans le consentement de EXM

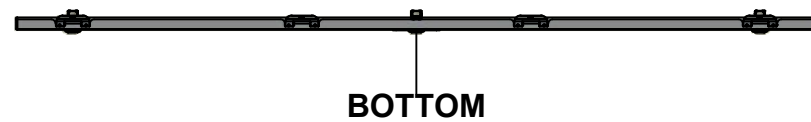
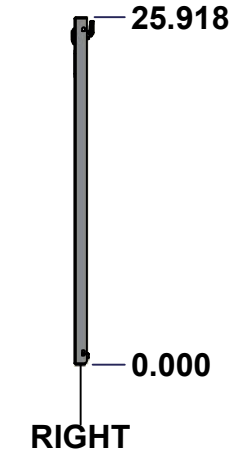
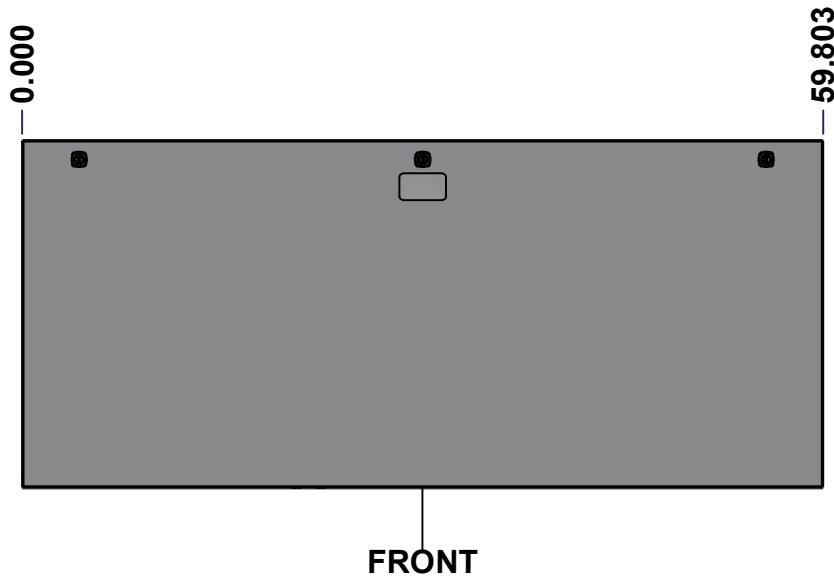
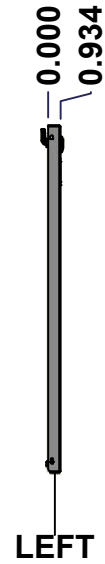
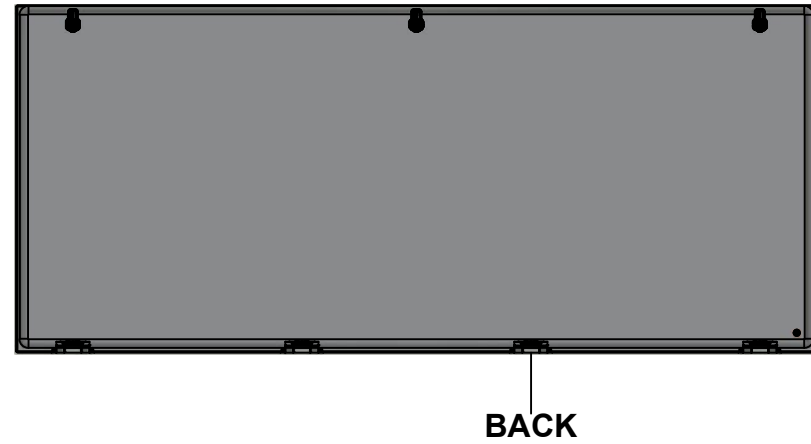
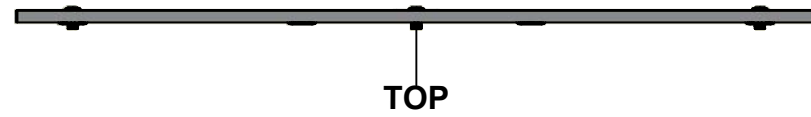

No.	Revisions	Date	By/Par

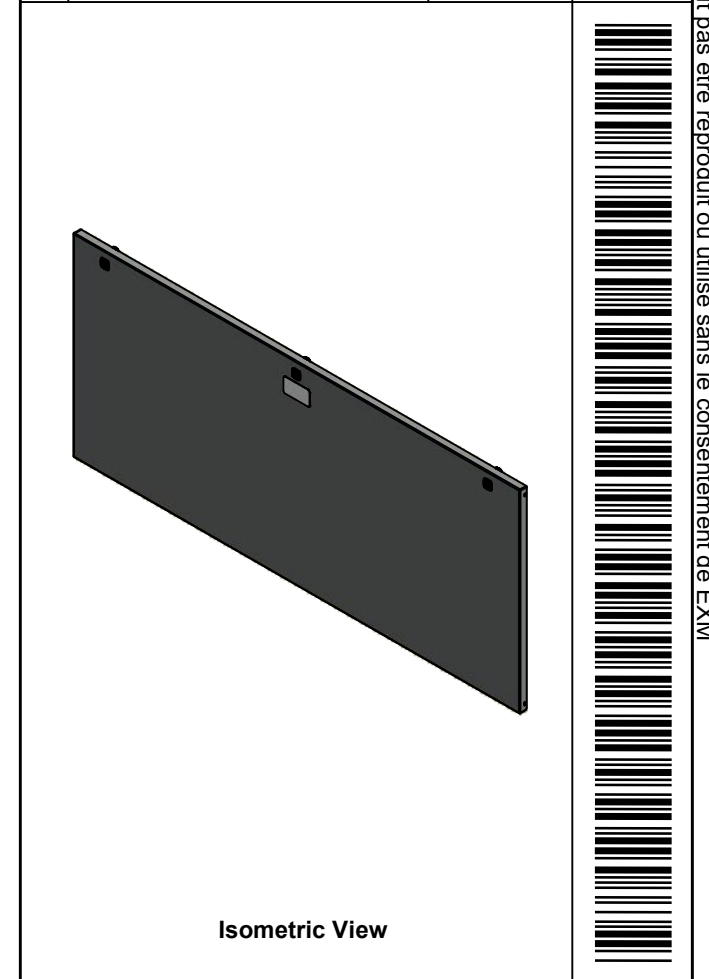

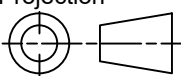
 Tél: (450) 979-4373 Fax: (450) 979-4626 www.exmweb.com		Flatness Aplatissement Max 3.0mm Projection 
Customer Client	Date	
Drawn By Dessiné Par	BoxCad: BoxCad	Date 2022-10-18
Material Matière	14 Ga Cold Rolled A1008 CS Type B (1.7mm)	
Color Couleur	Asa-61 Grey	Finish Fini Smooth
Description		Detail Rev.
1412BTCU 26" x 60" Cover		
Part Number Numéro Pièce	Rev.	12
1412BTCU05205DTC	0	16

SEE BILL OF MATERIAL ON LAST PAGE

This drawing is confidential and must not be reproduced or used without the consent of Eurobox

Ce dessin est confidentiel et ne doit pas être reproduit ou utilisé sans le consentement de Eurobox

STANDARD FEATURES ARE NOT LISTED IN THIS HOLE TABLE			
HOLE TABLE - FRONT VIEW (CUSTOM FEATURE ONLY)			
CUT-OUT	XDIM	YDIM	DESCRIPTION
1	1.500	1.486	GND STUD M6 x 16mm (Inside)
2	55.553	24.494	LOCK 880 SCQ4-SL @ 90.0°
3	29.902	24.494	LOCK 880 SCQ4-SL @ 90.0°
4	4.250	24.494	LOCK 880 SCQ4-SL @ 90.0°

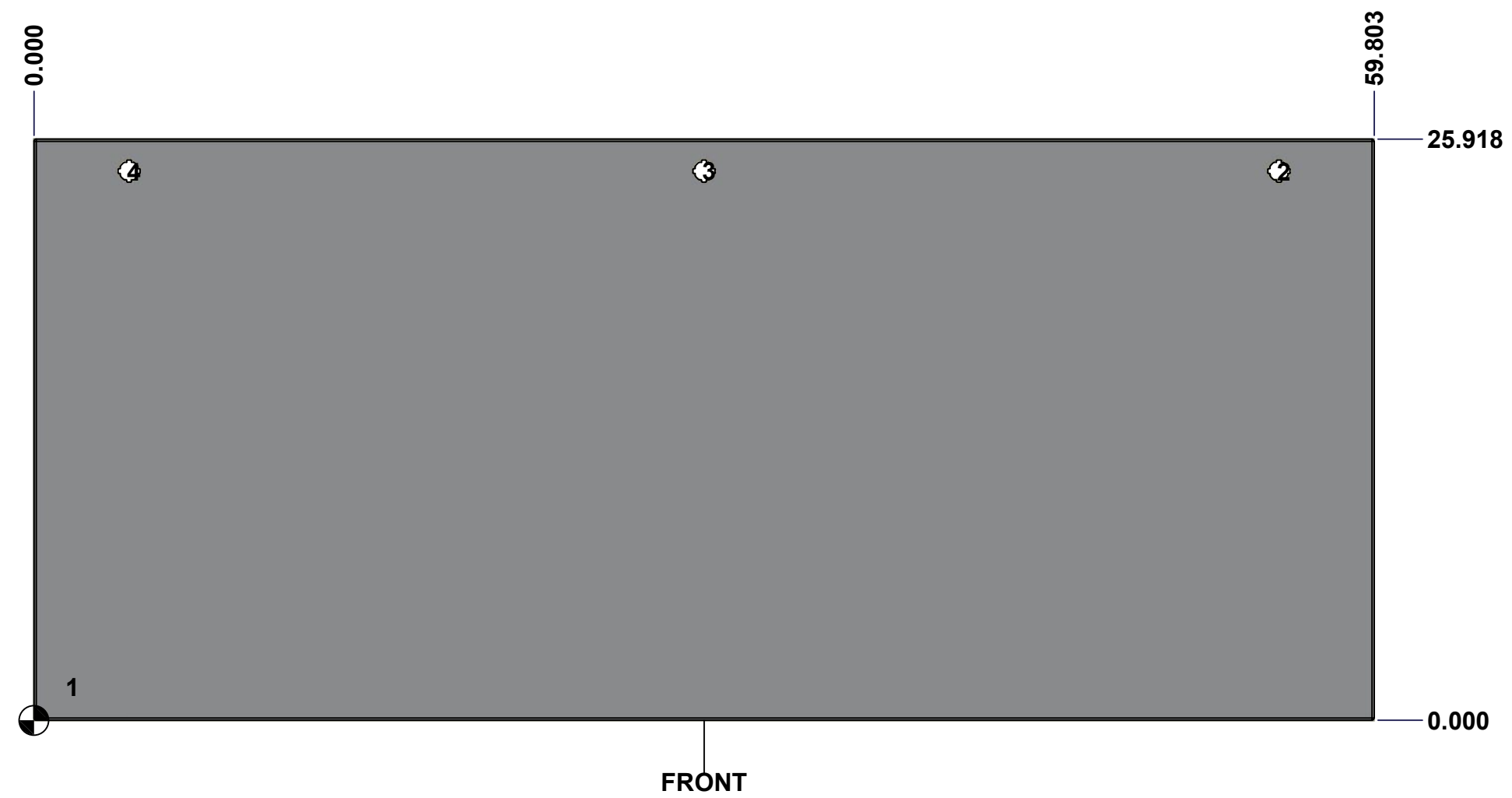

	Description	Status	
	1412BTCU 26" x 60" Cover	(NULL)	
	Part Number Numéro Pièce	Rev.	
	1412BTCU05205DTC	0	13 16

This drawing is confidential and must not be reproduced or used without the consent of EXM

Ce dessin est confidentiel et ne doit pas être reproduit ou utilisé sans le consentement de EXM

No.	Revisions	Date	By/Par

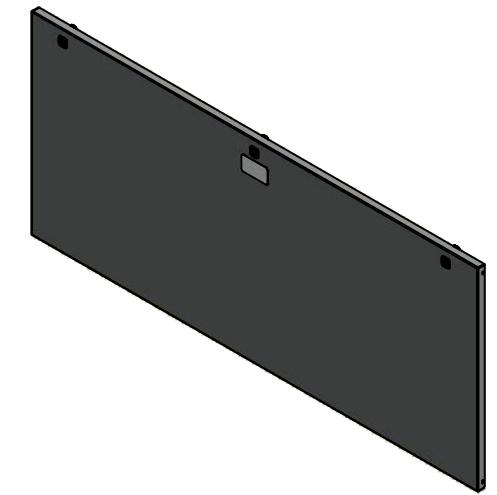

Isometric View

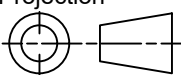

 Tél: (450) 979-4373 Fax: (450) 979-4626 www.exmweb.com	Flatness Aplatissement	Max 3.0mm
	Projection	
Customer Client	Date	
Drawn By Dessiné Par	BoxCad: BoxCad	Date 2022-10-18
Material Matière	14 Ga Cold Rolled A1008 CS Type B (1.7mm)	
Color Couleur	Asa-61 Grey	Finish Fini Smooth
Description	Detail Rev.	
1412BTCU 26" x 60" Cover		
Part Number Numéro Pièce	Rev. 0	14 / 16
1412BTCU05205DTC		

Qty	Part Name	Rev	Description
1	1412BTCU05205DTG	0	1412BTCU 26" x 60" Cover Gasket
1	STK-P-02400S	0	Powder Paint (Asa-61 Grey / Smooth)
4	STK-K-09800	10	5412 ES Hinge with 2 Captive Hinge Pins
1	STK-Q-16080	0	Ground Stud M6 x 16mm
1	STK-S-00100	0	3.5" x 2" Silver Milar Flexcon Sticker
1	1412BTCU05205DTC-P	0	1412BTCU 26" x 60" Cover Part
3	880 SCQ4-SL	6	5412 ES 1/4 Turn Lock
Parts List			

This drawing is confidential and must not be reproduced or used without the consent of EXM

Ce dessin est confidentiel et ne doit pas être reproduit ou utilisé sans le consentement de EXM

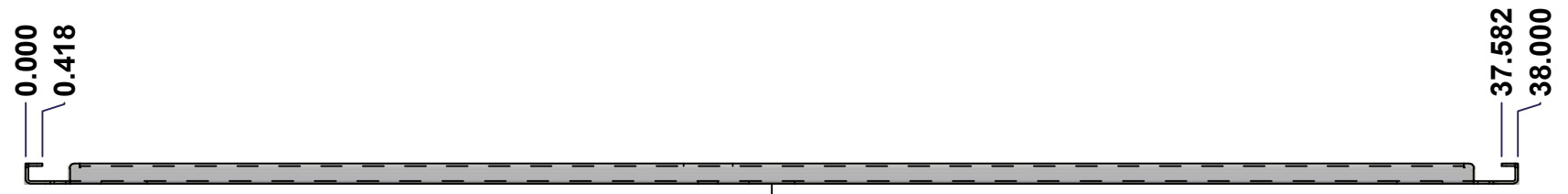

TOP

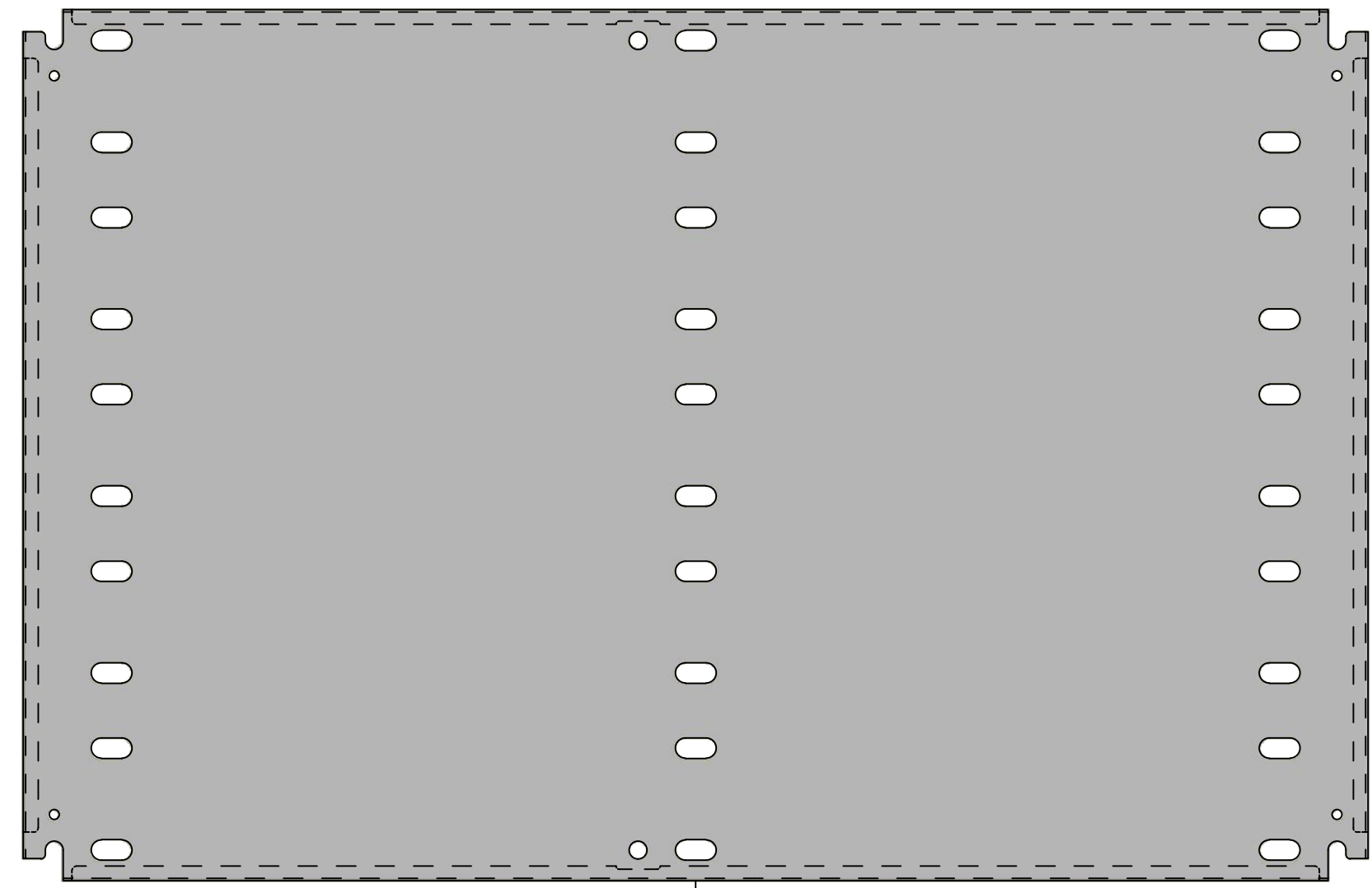

FRONT

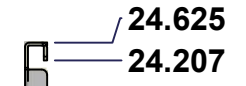

RIGHT

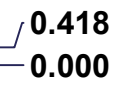

No.	Revisions	Date	By/Par

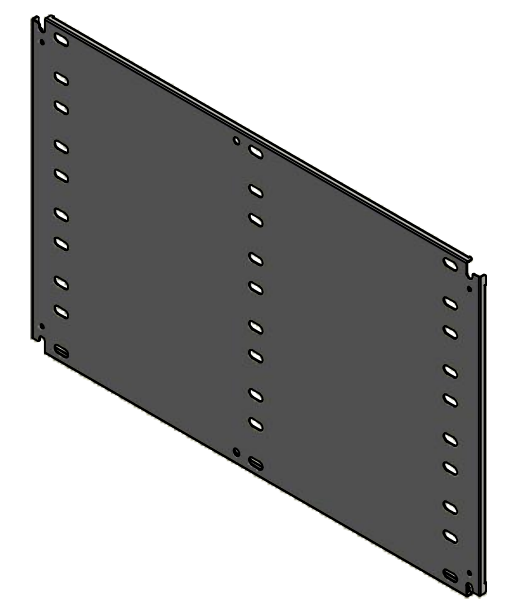

Isometric View

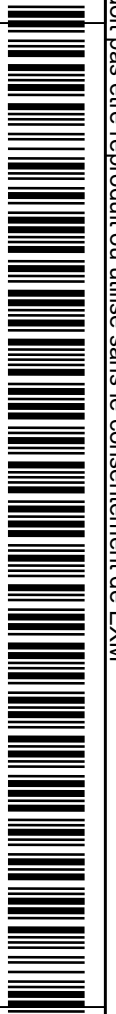

Tél: (450) 979-4373
 Fax: (450) 979-4626
www.exmweb.com

Flatness
Aplatissement
Max 3.0mm
Projection

Customer Client	Date
Drawn By / Dessiné Par: BoxCad: BoxCad	Date: 2022-10-18
Material / Matière: 14 Ga Cold Rolled A1008 CS Type B (1.7mm)	

Color / Couleur: White RAL9003	Finish / Fini: Smooth
--------------------------------	-----------------------

Description: 1412BTCU 24.625" x 38" Inner Panel	Detail Rev.
---	-------------

Part Number / Numéro Pièce: 1412BTCU05205DTIP1	Rev. 0	15	16
--	--------	----	----

SEE BILL OF MATERIAL ON LAST PAGE

This drawing is confidential and must not be reproduced or used without the consent of EXM

Ce dessin est confidentiel et ne doit pas être reproduit ou utilisé sans le consentement de EXM

No.	Revisions	Date	By/Par

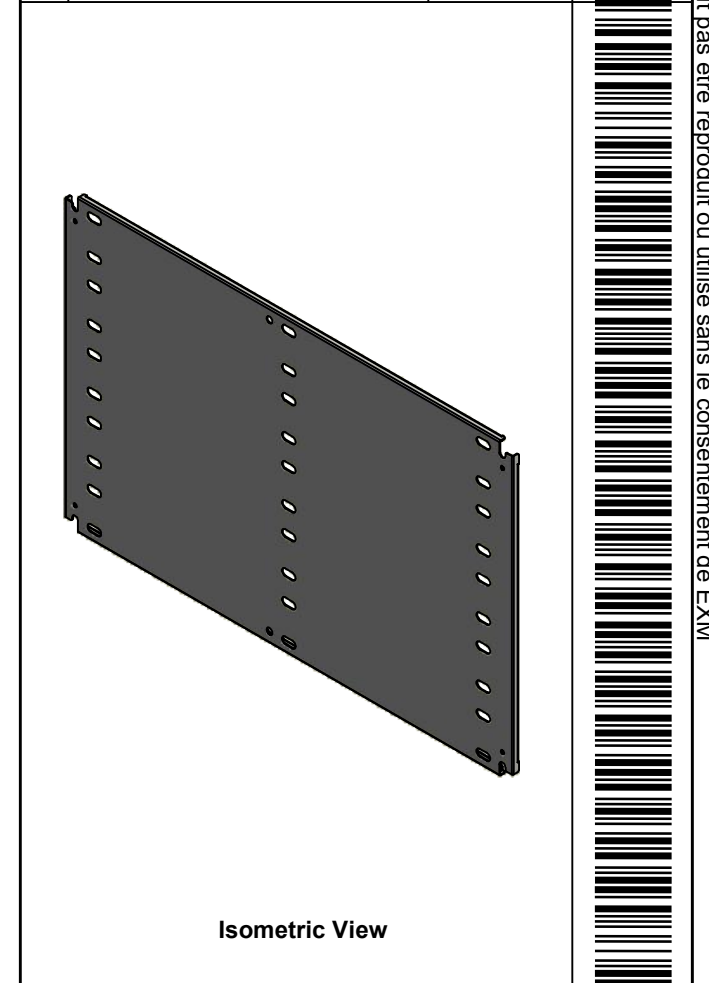

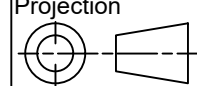
 Tél: (450) 979-4373 Fax: (450) 979-4626 www.exmweb.com		Flatness Aplatissement Max 3.0mm
Customer Client		Projection 
Drawn By / Dessiné Par: BoxCad: BoxCad		Date: 2022-10-18
Material / Matière: 14 Ga Cold Rolled A1008 CS Type B (1.7mm)		
Color / Couleur: White RAL9003	Finish / Fini: Smooth	
Description: 1412BTCU 24.625" x 38" Inner Panel		Detail Rev.
Part Number / Numéro Pièce: 1412BTCU05205DTIP1		Rev. 16 0

Qty	Part Number	Rev	Description
1	STK-P-02401S	0	Powder Paint (White / Smooth)
1	1412BTCU05205DTIP1-P	0	1412BTCU 24.625" x 60" Inner Panel Part
Parts List			