

This drawing is confidential and must not be reproduced or used without the consent of EXM

Ce dessin est confidentiel et ne doit pas être reproduit ou utilisé sans le consentement de EXM

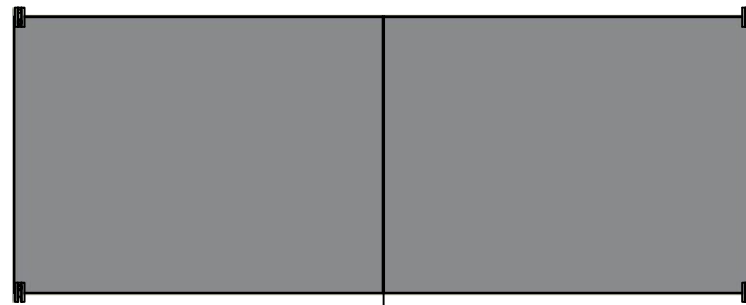

TOP



LEFT

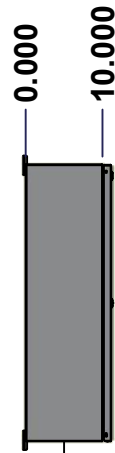

LEFT

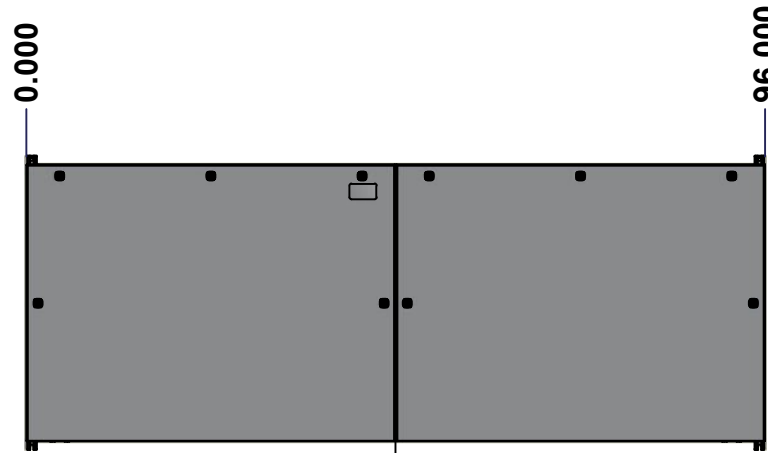

FRONT

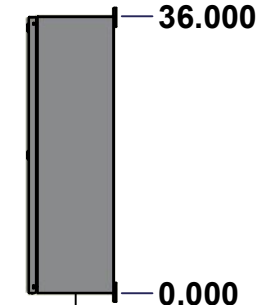

RIGHT



BOTTOM

| No. | Revisions | Date | By/Par |
|-----|-----------|------|--------|
|     |           |      |        |
|     |           |      |        |
|     |           |      |        |
|     |           |      |        |
|     |           |      |        |

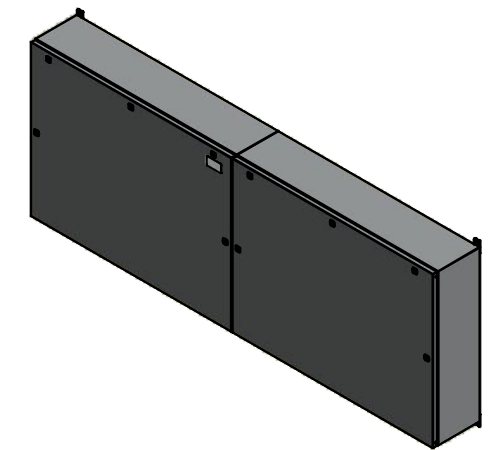

Isometric View



Tél: (450) 979-4373  
 Fax: (450) 979-4626  
[www.exmweb.com](http://www.exmweb.com)

Flatness  
Aplatissement

Max 3.0mm

Projection



|   |                       |
|---|-----------------------|
| Customer Client   | Date                  |
| Drawn By<br>Dessiné Par BoxCad: BoxCad                        | Date 2022-09-15       |
| Material<br>Matière 14 Ga Cold Rolled A1008 CS Type B (1.7mm) |                       |
| Color<br>Couleur Asa-61 Grey                                  | Finish<br>Fini Smooth |
| Description<br>1412BTCU 1200A - 5Wires x 96" Assembly         | Detail Rev.           |
| Part Number<br>Numéro Pièce <b>1412BTCU081205</b>             | Rev. <b>0</b>         |

SEE BILL OF MATERIAL ON LAST PAGE

This drawing is confidential and must not be reproduced or used without the consent of Eurobox

**STANDARD FEATURES ARE NOT LISTED IN THIS HOLE TABLE**

Ce dessin est confidentiel et ne doit pas être reproduit ou utilisé sans le consentement de Eurobox

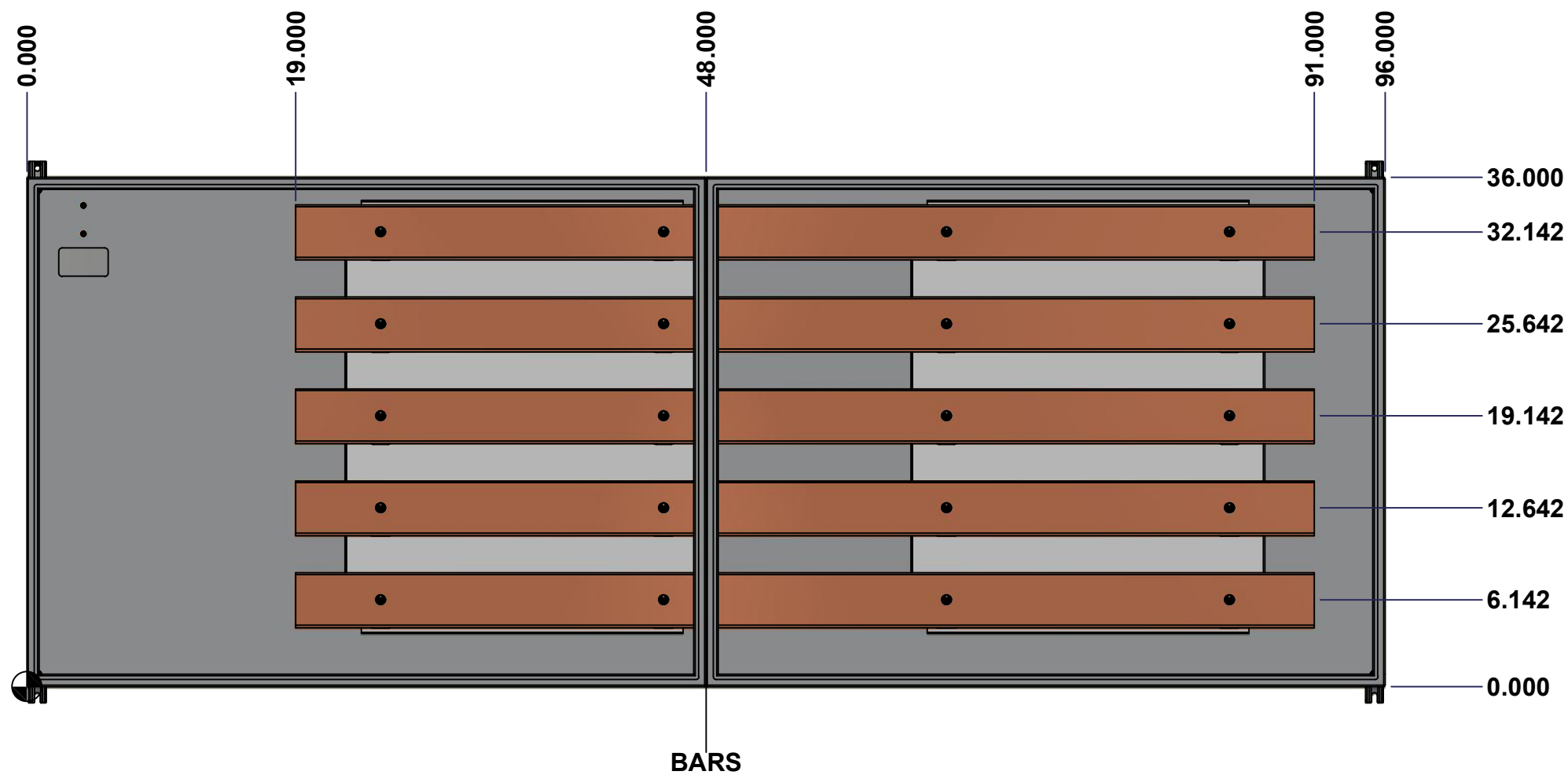

|                       |  |          |        |
|-----------------------|--|----------|--------|
|                       | Description                            |          | Status |
|                       | 1412BTCU 1200A - 5Wires x 96" Assembly |          | (NULL) |
| Part Number           |  | Rev.     | 2      |
| Numéro Pièce          |  | <b>0</b> | 13     |
| <b>1412BTCU081205</b> |  |          |        |

This drawing is confidential and must not be reproduced or used without the consent of EXM

Ce dessin est confidentiel et ne doit pas être reproduit ou utilisé sans le consentement de EXM

| NOTE |  |
|------|--|
| ITEM | DESCRIPTION                                |
| 1    | NEMA 4/12 Enclosure                        |
| 2    | C/W Standard ground studs on box and cover |
| 3    | W/O Standard door stiffener                |
| 4    | C/W Special inner panel (Sold separately)  |
| 5    | C/W Standard inner panel mounting studs    |

| No. | Revisions | Date | By/Par |
|-----|-----------|------|--------|
|     |           |      |        |
|     |           |      |        |
|     |           |      |        |
|     |           |      |        |
|     |           |      |        |
|     |           |      |        |

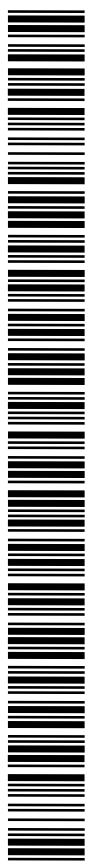
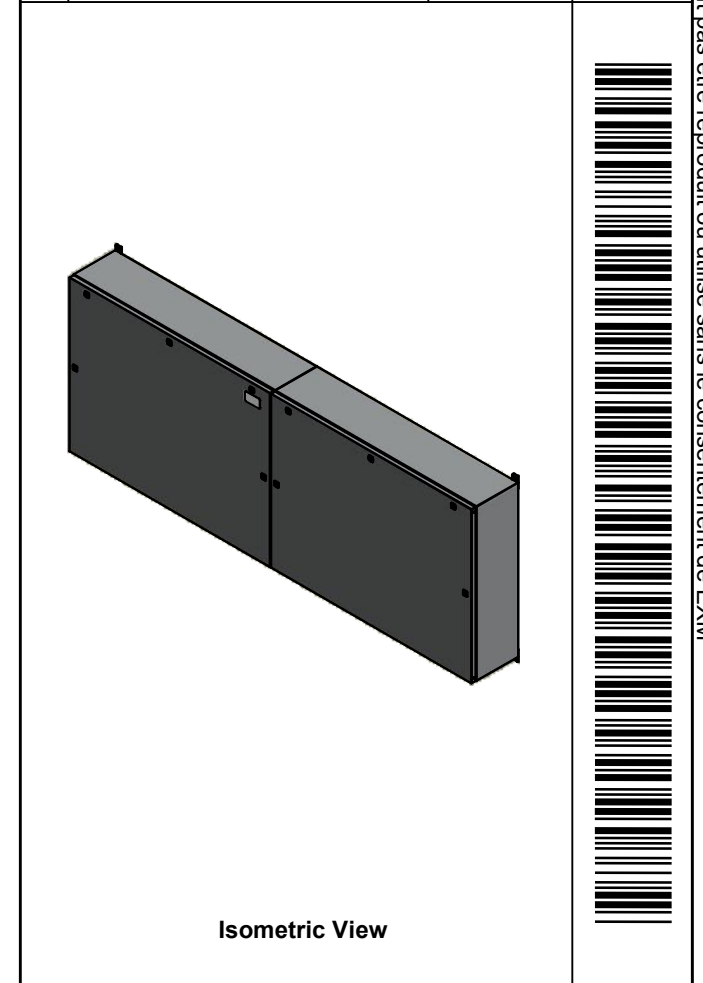

| PACKING               |     |  |
|-----------------------|-----|--|
| ITEM                  | QTY | DESCRIPTION                                    |
| Cardboard sleeve      | 2   | Top and Bottom                                 |
| Cardboard strip       | 2   | Between back of enclosure and inner panel      |
| Plastic bag           | 1   | To protect cover surface and inside gasket     |
| Cardboard corner      | 4   | To reinforced for the plastic strap tightening |
| Plastic strap - Black | 2   | To Squeeze 2 cardboard sleeve together         |
| Packaging label       | 3   | White label with PN                            |
| Plastic strap- Green  | 2   | To secure the enclosure to the wood pallet     |
| Wood Pallet           | 1   | 2" deeper and 3" larger than enclosure size    |

|            |                      |     |  |
|------------|----------------------|-----|--|
| 1          | 885 ESMF1            | 0   | 885 ESMF1 Mounting Feet Kit                            |
| 1          | 1412BTCU081205IP2    | 0   | 1412BTCU 30.625" x 28" Right Inner Panel               |
| 1          | 1412BTCU081205BAR1-P | 0   | Rounded Edge Copper Bar 5/16" x 4"                     |
| 1          | 1412BTCU081205BAR2-P | 0   | Rounded Edge Copper Bar 5/16" x 4"                     |
| 1          | 1412BTCU081205BAR3-P | 0   | Rounded Edge Copper Bar 5/16" x 4"                     |
| 1          | 1412BTCU081205BAR4-P | 0   | Rounded Edge Copper Bar 5/16" x 4"                     |
| 1          | 1412BTCU081205BAR5-P | 0   | Rounded Edge Copper Bar 5/16" x 4"                     |
| 1          | 1412BTCU081205IP1    | 0   | 1412BTCU 30.625" x 65" Inner Panel                     |
| 20         | STK-A-67400          | 0   | Buss Bar Insulator Kit                                 |
| 1          | STK-K-01800          | 5   | 5412 ES Accessory Kit                                  |
| 8          | STK-Q-04050-07       | 7   | M6 x 7mm Hexagon Socket Head Machine Screw with Nyseal |
| 28         | STK-Q-07310          | 2   | Flange Lock Nut M8                                     |
| 8          | STK-Q-07610          | 8   | M8 Plastic Spacer 22.2mm                               |
| 1          | 1412BTCU081205B      | 0   | 1412BTCU 36" x 96" x 10" Body                          |
| 1          | 1412BTCU081205C      | 0   | 1412BTCU 36" x 96" Cover                               |
| Qty        | Part Number          | Rev | Description  |
| Parts List |                      |     |  |

|   |  |  |
|---|--|--|
|   | Tél: (450) 979-4373<br>Fax: (450) 979-4626<br><a href="http://www.exmweb.com">www.exmweb.com</a> | Flatness<br>Aplatissement<br>Max 3.0mm |
|   | Projection<br>   | Customer<br>Client                     |
| Drawn By<br>Dessiné Par                               | BoxCad: BoxCad   | Date<br>2022-09-15                     |
| Material<br>Matière                                   | 14 Ga Cold Rolled A1008 CS Type B (1.7mm)  |  |
| Color<br>Couleur                                      | Asa-61 Grey  | Finish<br>Fini<br>Smooth               |
| Description<br>1412BTCU 1200A - 5Wires x 96" Assembly |  | Detail Rev.                            |
| Part Number<br>Numéro Pièce<br><b>1412BTCU081205</b>  |  | Rev. 0<br>3<br>13                      |

This drawing is confidential and must not be reproduced or used without the consent of EXM

Ce dessin est confidentiel et ne doit pas être reproduit ou utilisé sans le consentement de EXM

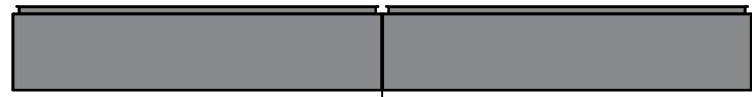

TOP



BACK

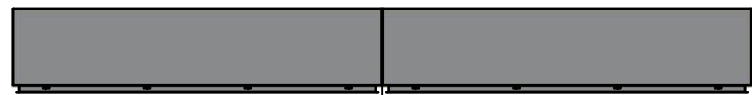

BOTTOM

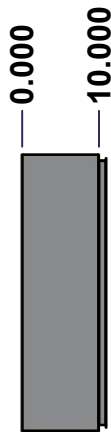

LEFT

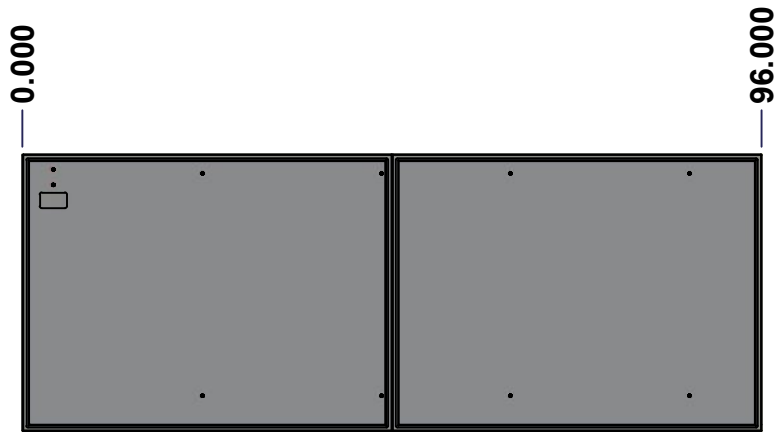

FRONT

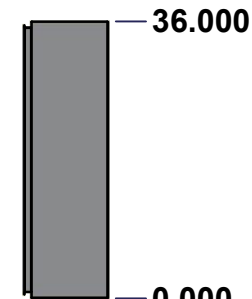

RIGHT

| No. | Revisions | Date | By/Par |
|-----|-----------|------|--------|
|     |           |      |        |
|     |           |      |        |
|     |           |      |        |
|     |           |      |        |
|     |           |      |        |

Isometric View

|  |   |                           |
|--|---|---------------------------|
| Tél: (450) 979-4373<br>Fax: (450) 979-4626<br><a href="http://www.exmweb.com">www.exmweb.com</a> |   | Flatness<br>Aplatissement |
|  |   | Max 3.0mm                 |
| Projection   |   | Date                      |
| Customer<br>Client   | BoxCad: BoxCad                            | Date 2022-09-15           |
| Material<br>Matière  | 14 Ga Cold Rolled A1008 CS Type B (1.7mm) |                           |
| Color<br>Couleur   | Asa-61 Grey                               | Finish<br>Fini Smooth     |
| Description  |   | Detail Rev.               |
| 1412BTCU 36" x 96" x 10" Body  |   |                           |
| Part Number<br>Numéro Pièce  | 1412BTCU081205B                           | Rev. 4                    |
| SEE BILL OF MATERIAL ON LAST PAGE  |   | 0                         |

This drawing is confidential and must not be reproduced or used without the consent of Eurobox

Ce dessin est confidentiel et ne doit pas être reproduit ou utilisé sans le consentement de Eurobox

| STANDARD FEATURES ARE NOT LISTED IN THIS HOLE TABLE |        |        |                             |
|---|--------|--------|-----------------------------|
| HOLE TABLE - BACK VIEW (CUSTOM FEATURE ONLY)        |        |        |                             |
| CUT-OUT   | XDIM   | YDIM   | DESCRIPTION                 |
| 1   | 92.000 | 34.000 | GND STUD M8 x 35mm (Inside) |
| 2   | 92.000 | 32.000 | GND STUD M8 x 35mm (Inside) |
| 3   | 9.375  | 33.500 | IP STUD M8 x 35mm (Inside)  |
| 4   | 32.625 | 33.500 | IP STUD M8 x 35mm (Inside)  |
| 5   | 9.375  | 4.625  | IP STUD M8 x 35mm (Inside)  |
| 6   | 32.625 | 4.625  | IP STUD M8 x 35mm (Inside)  |
| 7   | 49.375 | 33.500 | IP STUD M8 x 35mm (Inside)  |
| 8   | 72.625 | 33.500 | IP STUD M8 x 35mm (Inside)  |
| 9   | 49.375 | 4.625  | IP STUD M8 x 35mm (Inside)  |
| 10  | 72.625 | 4.625  | IP STUD M8 x 35mm (Inside)  |

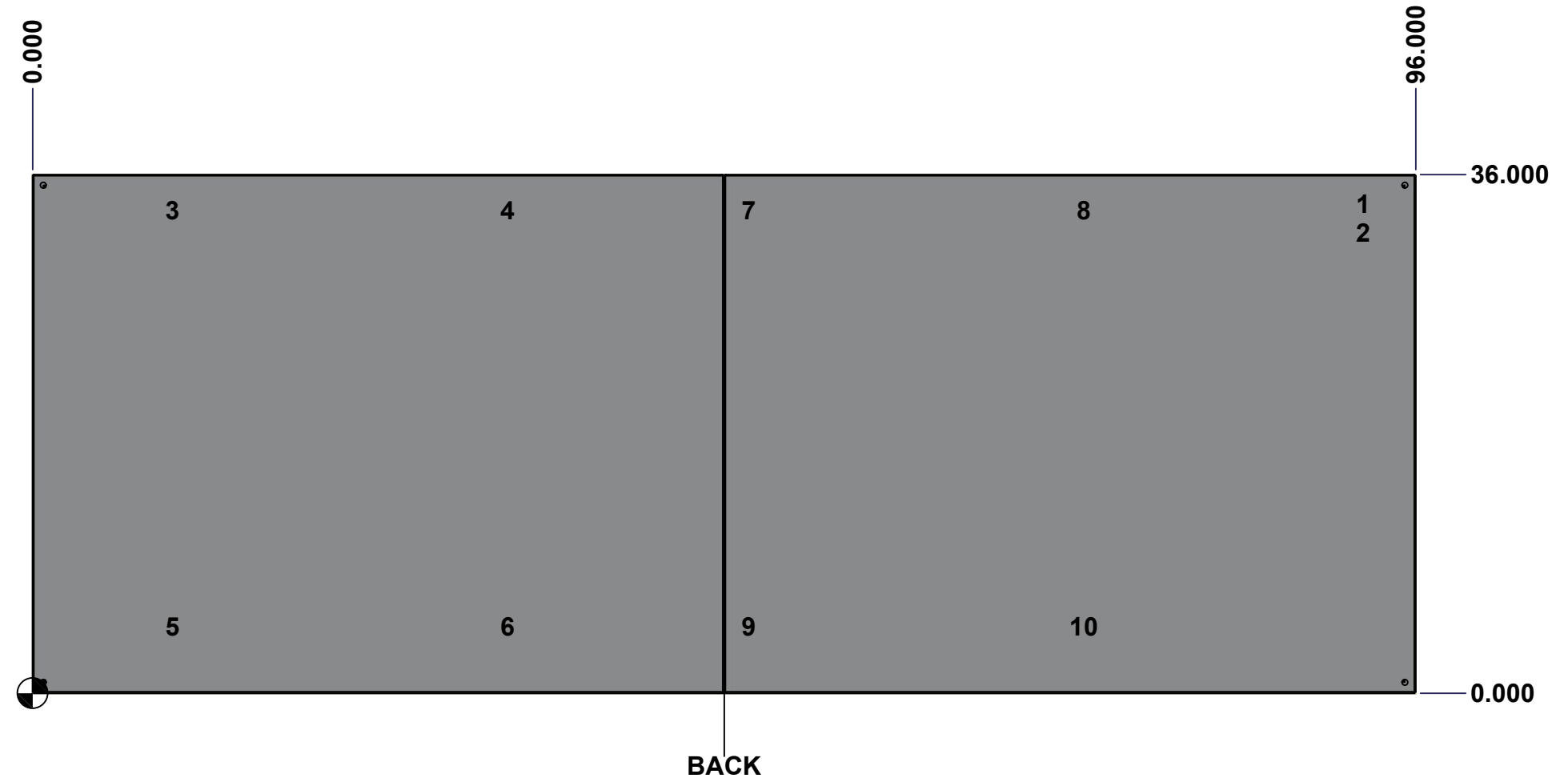

|  |                               |          |    |
|--|-------------------------------|----------|----|
|  | Description                   | Status   |    |
|  | 1412BTCU 36" x 96" x 10" Body | (NULL)   |    |
|  | Part Number<br>Numéro Pièce   | Rev.     | 5  |
|  | <b>1412BTCU081205B</b>        | <b>0</b> | 13 |

This drawing is confidential and must not be reproduced or used without the consent of EXM

Ce dessin est confidentiel et ne doit pas être reproduit ou utilisé sans le consentement de EXM

| No. | Revisions | Date | By/Par |
|-----|-----------|------|--------|
|     |           |      |        |
|     |           |      |        |
|     |           |      |        |
|     |           |      |        |
|     |           |      |        |

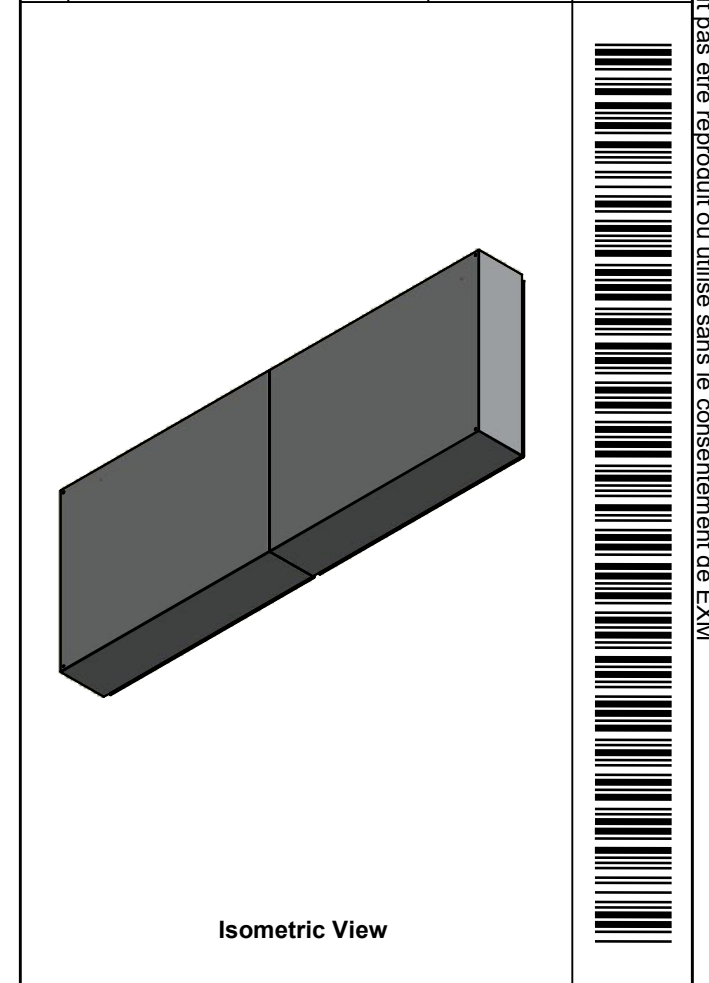

 Tél: (450) 979-4373  
 Fax: (450) 979-4626  
[www.exmweb.com](http://www.exmweb.com)

**Flatness**  
 Aplatissement  
 Max 3.0mm  
**Projection**  

|   |                  |
|---|------------------|
| Customer Client   | Date             |
| Drawn By / Dessiné Par: BoxCad: BoxCad                        | Date: 2022-09-15 |
| Material / Matière: 14 Ga Cold Rolled A1008 CS Type B (1.7mm) |                  |

|  |                       |
|--|-----------------------|
| Color / Couleur: Asa-61 Grey               | Finish / Fini: Smooth |
| Description: 1412BTCU 36" x 96" x 10" Body | Detail Rev.           |

|  |        |   |
|--|--------|---|
| Part Number / Numéro Pièce: <b>1412BTCU081205B</b> | Rev. 0 | 6 |
|--|--------|---|

| Qty        | Part Number       | Rev | Description                              |
|------------|-------------------|-----|--|
| 1          | STK-P-02400S      | 0   | Powder Paint (Asa-61 Grey / Smooth)      |
| 1          | 1412BTCU081205B-P | 0   | 1412BTCU 36" x 96" x 10" Body Part       |
| 1          | 1412BTCU081205E-P | 0   | 1412BTCU 36" x 96" x 10" Right Body Part |
| 1          | STK-G-00701       | 0   | 1" x 1/4" Self-Adhesive Neoprene Gasket  |
| 10         | STK-Q-00260       | 1   | M6 x 13mm Carriage Bolt                  |
| 10         | STK-Q-07220       | 1   | M6 Nylon Insert Lock Nut                 |
| 10         | STK-Q-16005       | 1   | Stud M8 x 35 (No Paint Cap Required)     |
| 2          | STK-Q-16080       | 0   | Ground Stud M6 x 16mm                    |
| 1          | STK-S-00100       | 0   | 3.5" x 2" Silver Milar Flexcon Sticker   |
| Parts List |                   |     |  |

This drawing is confidential and must not be reproduced or used without the consent of EXM

Ce dessin est confidentiel et ne doit pas être reproduit ou utilisé sans le consentement de EXM



TOP

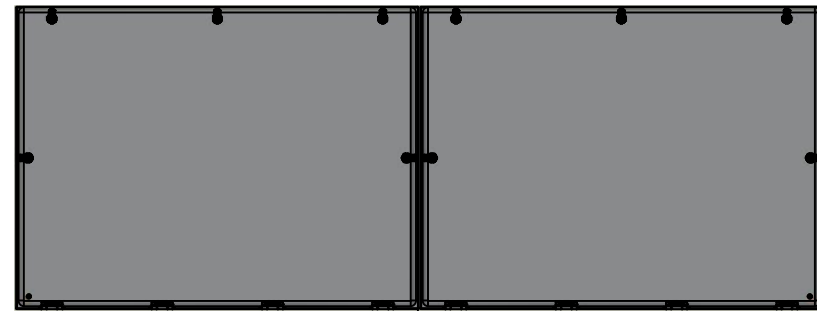

BACK



BOTTOM

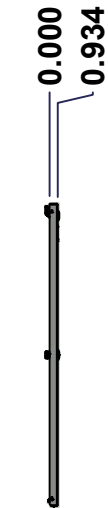

LEFT

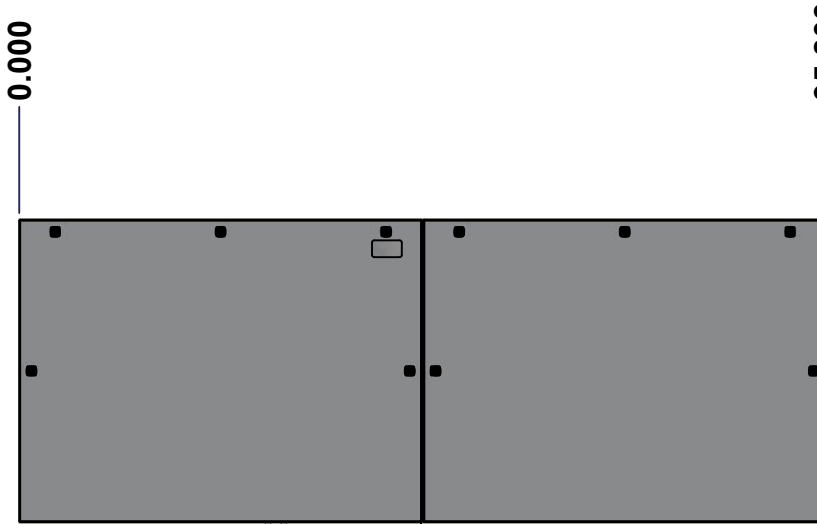

FRONT

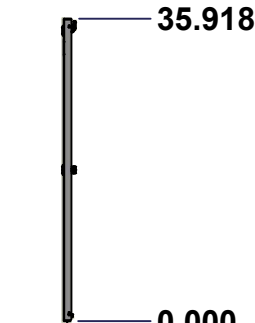

RIGHT

| No. | Revisions | Date | By/Par |
|-----|-----------|------|--------|
|     |           |      |        |
|     |           |      |        |
|     |           |      |        |
|     |           |      |        |

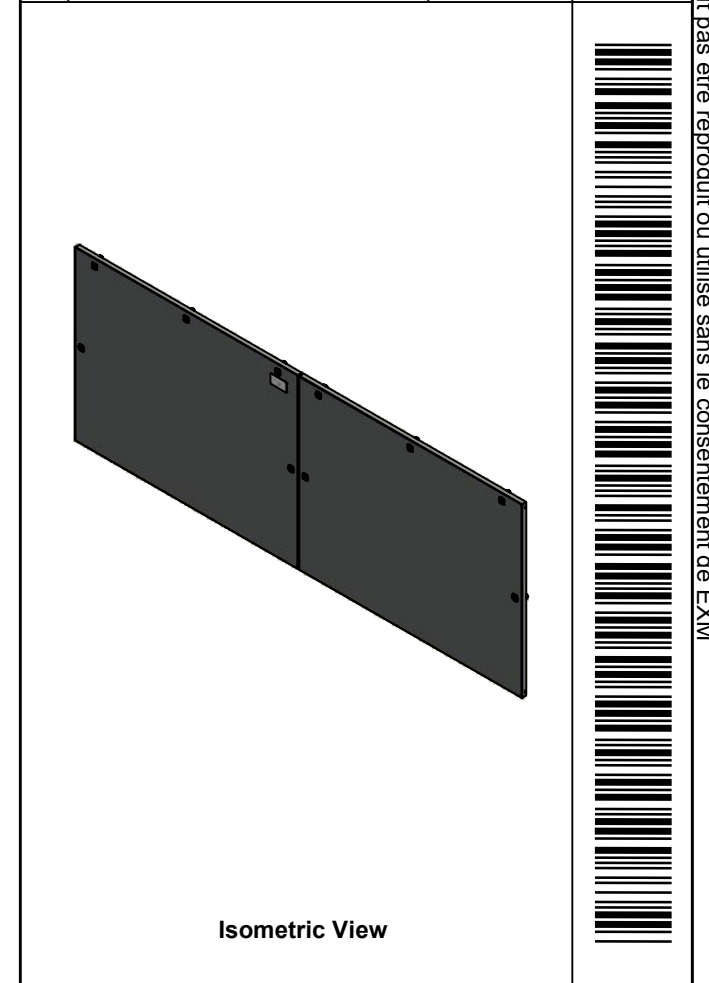

Isometric View

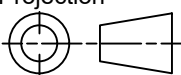
|  |   |   |
|--|---|---|
|  Tél: (450) 979-4373<br>Fax: (450) 979-4626<br><a href="http://www.exmweb.com">www.exmweb.com</a> |   | Flatness<br>Aplatissement<br>Max 3.0mm<br>Projection<br> |
| Customer Client  | Date                                      |   |
| Drawn By<br>Dessiné Par  | BoxCad: BoxCad                            | Date 2022-09-15   |
| Material<br>Matière  | 14 Ga Cold Rolled A1008 CS Type B (1.7mm) |   |
| Color<br>Couleur   | Asa-61 Grey                               | Finish<br>Fini Smooth   |
| Description<br>1412BTCU 36" x 96" Cover  |   | Detail Rev.   |
| Part Number<br>Numéro Pièce  | 1412BTCU081205C                           | Rev. 7<br>0   |

SEE BILL OF MATERIAL ON LAST PAGE

This drawing is confidential and must not be reproduced or used without the consent of Eurobox

Ce dessin est confidentiel et ne doit pas être reproduit ou utilisé sans le consentement de Eurobox

**STANDARD FEATURES ARE NOT LISTED IN THIS HOLE TABLE**

**HOLE TABLE - FRONT VIEW (CUSTOM FEATURE ONLY)**

| CUT-OUT | XDIM   | YDIM   | DESCRIPTION                 |
|---------|--------|--------|-----------------------------|
| 1       | 1.500  | 1.486  | GND STUD M6 x 16mm (Inside) |
| 2       | 94.303 | 1.486  | GND STUD M6 x 16mm (Inside) |
| 3       | 94.379 | 17.959 | LOCK 880 SCQ4-SL @ 0.0°     |
| 4       | 49.424 | 17.959 | LOCK 880 SCQ4-SL @ 180.0°   |
| 5       | 46.379 | 17.959 | LOCK 880 SCQ4-SL @ 0.0°     |
| 6       | 1.424  | 17.959 | LOCK 880 SCQ4-SL @ 180.0°   |
| 7       | 91.553 | 34.494 | LOCK 880 SCQ4-SL @ 90.0°    |
| 8       | 71.902 | 34.494 | LOCK 880 SCQ4-SL @ 90.0°    |
| 9       | 52.250 | 34.494 | LOCK 880 SCQ4-SL @ 90.0°    |
| 10      | 43.553 | 34.494 | LOCK 880 SCQ4-SL @ 90.0°    |
| 11      | 23.902 | 34.494 | LOCK 880 SCQ4-SL @ 90.0°    |
| 12      | 4.250  | 34.494 | LOCK 880 SCQ4-SL @ 90.0°    |

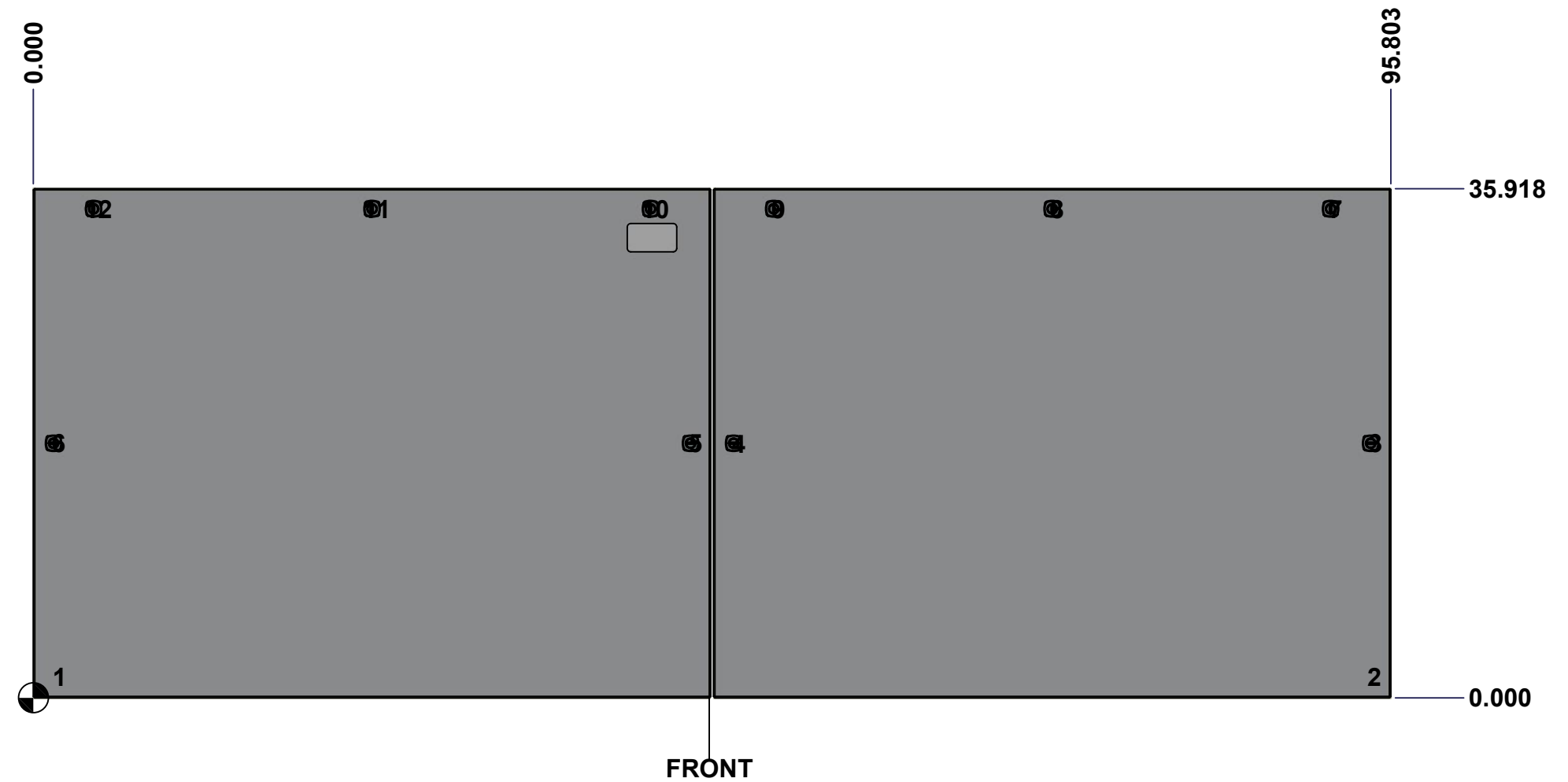

|  |                             |              |
|--|-----------------------------|--------------|
|  | Description                 | Status       |
|  | 1412BTCU 36" x 96" Cover    | (NULL)       |
|  | Part Number<br>Numéro Pièce | Rev.         |
|  | <b>1412BTCU081205C</b>      | <b>0</b> / 8 |
|  |                             | 13           |



This drawing is confidential and must not be reproduced or used without the consent of EXM

Ce dessin est confidentiel et ne doit pas être reproduit ou utilisé sans le consentement de EXM

| No. | Revisions | Date | By/Par |
|-----|-----------|------|--------|
|     |           |      |        |
|     |           |      |        |
|     |           |      |        |
|     |           |      |        |
|     |           |      |        |

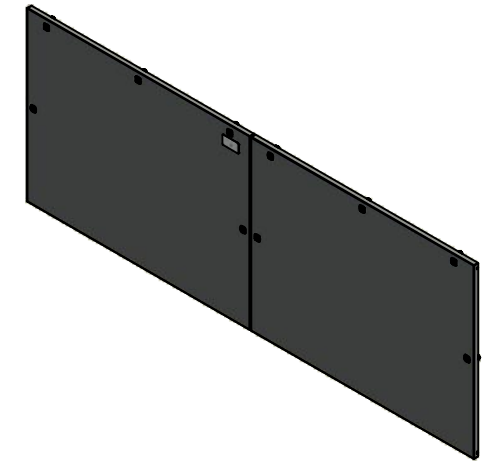

Isometric View

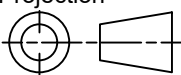

|  |   |   |
|--|---|---|
|  Tél: (450) 979-4373<br>Fax: (450) 979-4626<br><a href="http://www.exmweb.com">www.exmweb.com</a> | Flatness<br>Aplatissement                 | Max 3.0mm   |
|  | Projection                                |  |
| Customer<br>Client   | Date                                      |   |
| Drawn By<br>Dessiné Par  | BoxCad: BoxCad                            | Date 2022-09-15   |
| Material<br>Matière  | 14 Ga Cold Rolled A1008 CS Type B (1.7mm) |   |
| Color<br>Couleur   | Asa-61 Grey                               | Finish<br>Fini Smooth   |
| Description  | Detail Rev.                               |   |
| 1412BTCU 36" x 96" Cover   |   |   |
| Part Number<br>Numéro Pièce  | Rev.                                      | 9   |
| <b>1412BTCU081205C</b>   | <b>0</b>                                  | 13  |

| Qty        | Part Name         | Rev | Description                             |
|------------|-------------------|-----|---|
| 2          | 1412BTCU081205G   | 0   | 1412BTCU 36" x 96" Cover Gasket         |
| 1          | STK-P-02400S      | 0   | Powder Paint (Asa-61 Grey / Smooth)     |
| 8          | STK-K-09800       | 10  | 5412 ES Hinge with 2 Captive Hinge Pins |
| 2          | STK-Q-16080       | 0   | Ground Stud M6 x 16mm                   |
| 1          | STK-S-00100       | 0   | 3.5" x 2" Silver Milar Flexcon Sticker  |
| 1          | 1412BTCU081205C-P | 0   | 1412BTCU 36" x 96" Cover Part           |
| 1          | 1412BTCU081205F-P | 0   | 1412BTCU 36" x 96" Right Cover Part     |
| 10         | 880 SCQ4-SL       | 6   | 5412 ES 1/4 Turn Lock                   |
| Parts List |                   |     |   |

This drawing is confidential and must not be reproduced or used without the consent of EXM

Ce dessin est confidentiel et ne doit pas être reproduit ou utilisé sans le consentement de EXM

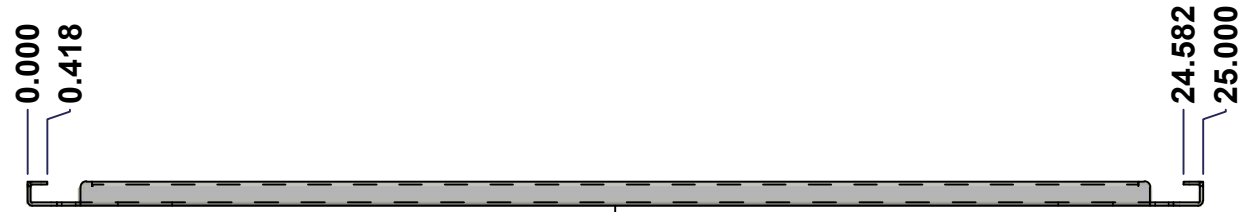

TOP

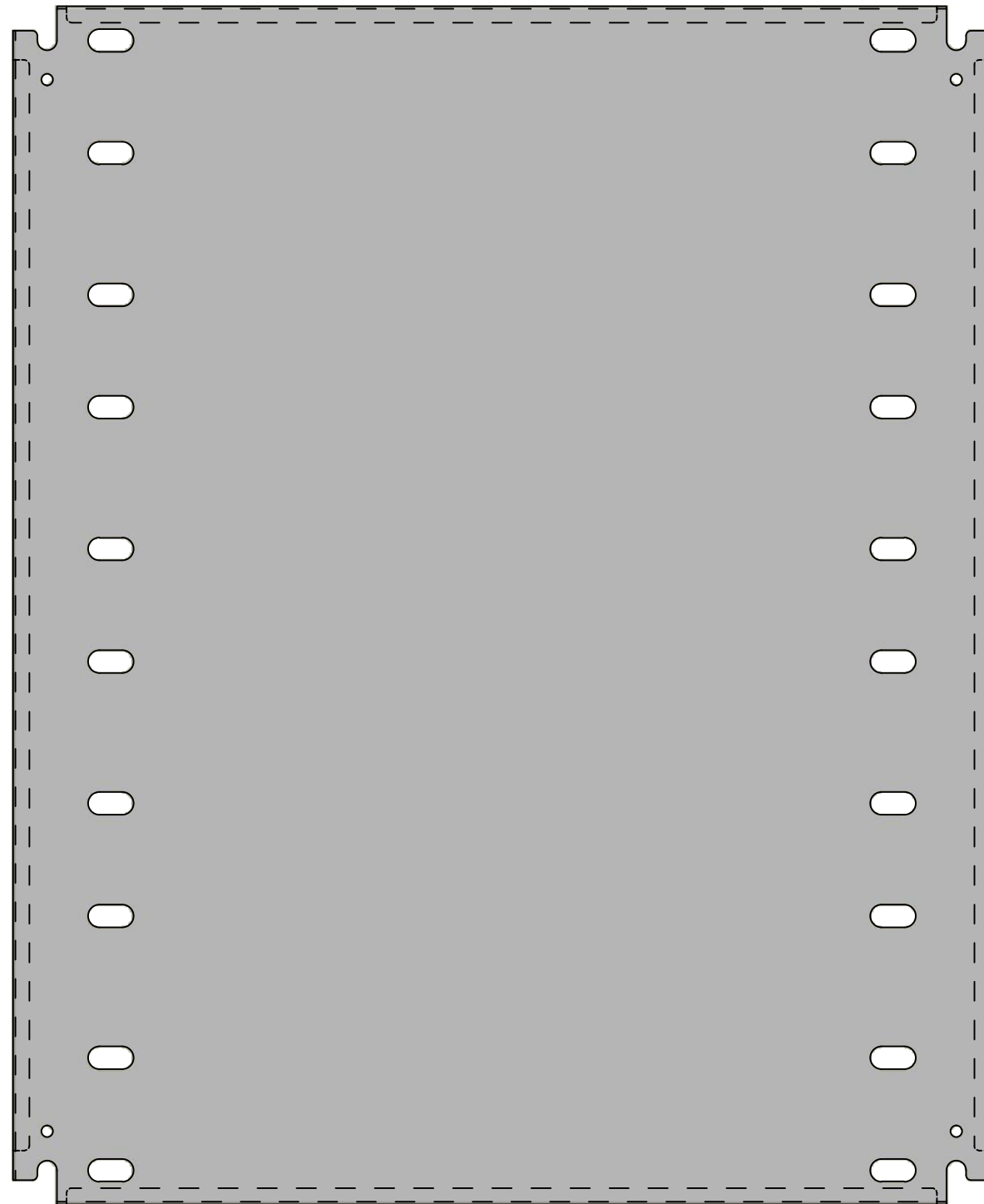

FRONT

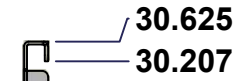

RIGHT



SEE BILL OF MATERIAL ON LAST PAGE

| No. | Revisions | Date | By/Par |
|-----|-----------|------|--------|
|     |           |      |        |
|     |           |      |        |
|     |           |      |        |
|     |           |      |        |
|     |           |      |        |

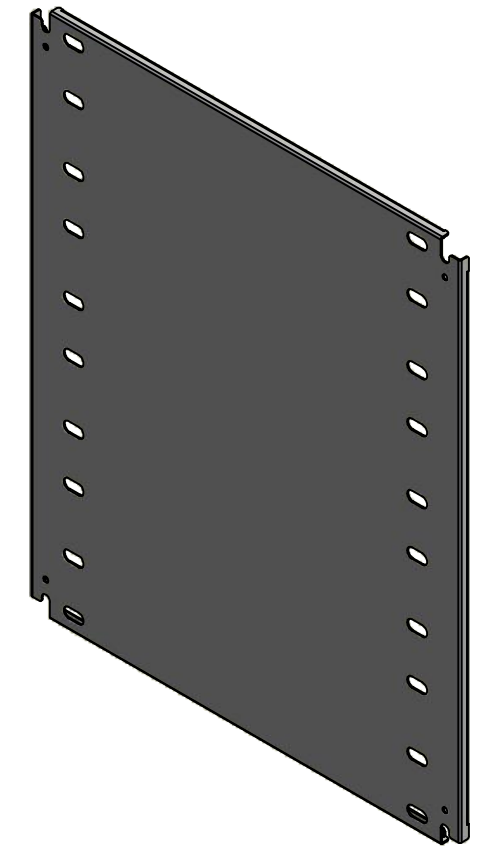

Isometric View



Tél: (450) 979-4373  
 Fax: (450) 979-4626  
[www.exmweb.com](http://www.exmweb.com)

Flatness  
Aplatissement

Max 3.0mm

Projection

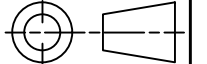

|   |                 |
|---|-----------------|
| Customer Client   | Date            |
| Drawn By<br>Dessiné Par BoxCad: BoxCad                        | Date 2022-09-15 |
| Material<br>Matière 14 Ga Cold Rolled A1008 CS Type B (1.7mm) |                 |

|                                |                       |
|--------------------------------|-----------------------|
| Color<br>Couleur White RAL9003 | Finish<br>Fini Smooth |
|--------------------------------|-----------------------|

|   |             |
|---|-------------|
| Description<br>1412BTCU 30.625" x 65" Inner Panel | Detail Rev. |
|---|-------------|

|   |                  |          |
|---|------------------|----------|
| Part Number<br>Numéro Pièce<br><b>1412BTCU081205IP1</b> | Rev.<br><b>0</b> | 10<br>13 |
|---|------------------|----------|

This drawing is confidential and must not be reproduced or used without the consent of EXM

Ce dessin est confidentiel et ne doit pas être reproduit ou utilisé sans le consentement de EXM

| No. | Revisions | Date | By/Par |
|-----|-----------|------|--------|
|     |           |      |        |
|     |           |      |        |
|     |           |      |        |
|     |           |      |        |
|     |           |      |        |

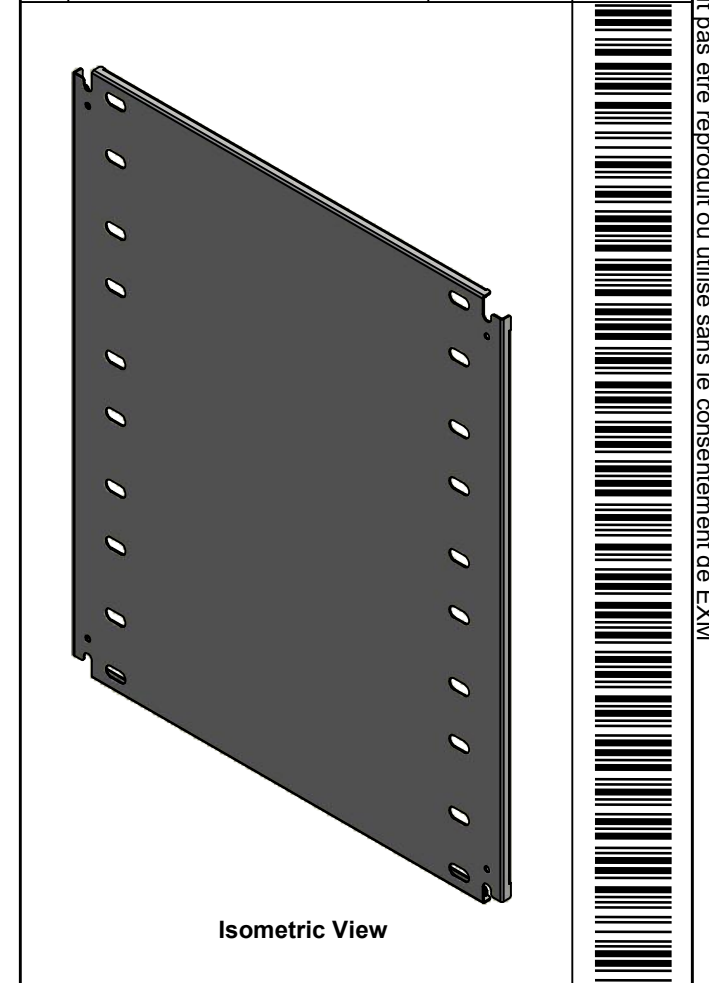

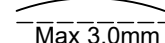
|  |                       |  |
|--|-----------------------|--|
|  Tél: (450) 979-4373<br>Fax: (450) 979-4626<br><a href="http://www.exmweb.com">www.exmweb.com</a> |                       | Flatness<br>Aplatissement<br> Max 3.0mm |
| Customer Client  |                       | Date   |
| Drawn By / Dessiné Par: BoxCad: BoxCad   |                       | Date: 2022-09-15   |
| Material / Matière: 14 Ga Cold Rolled A1008 CS Type B (1.7mm)  |                       |  |
| Color / Couleur: White RAL9003   | Finish / Fini: Smooth |  |
| Description: 1412BTCU 30.625" x 65" Inner Panel  |                       | Detail Rev.  |
| Part Number / Numéro Pièce: <b>1412BTCU081205IP1</b>   |                       | Rev. 11<br><b>0</b>  |

| Qty        | Part Number         | Rev | Description                             |
|------------|---------------------|-----|---|
| 1          | STK-P-02401S        | 0   | Powder Paint (White / Smooth)           |
| 1          | 1412BTCU081205IP1-P | 0   | 1412BTCU 30.625" x 96" Inner Panel Part |
| Parts List |                     |     |   |

This drawing is confidential and must not be reproduced or used without the consent of EXM

Ce dessin est confidentiel et ne doit pas être reproduit ou utilisé sans le consentement de EXM

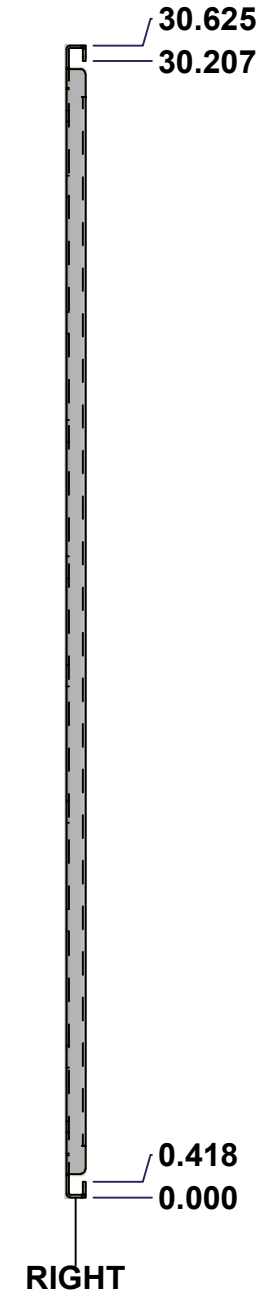
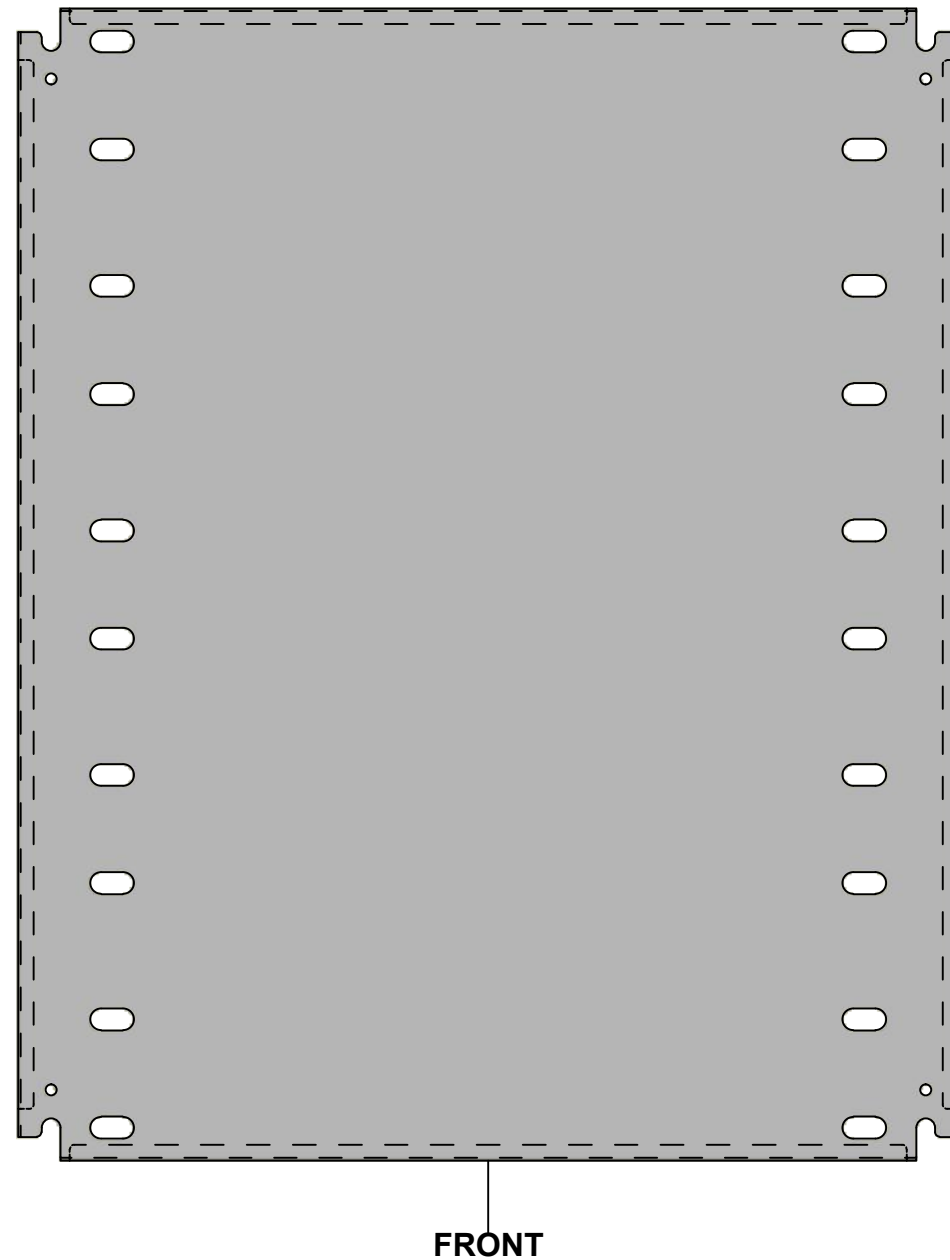
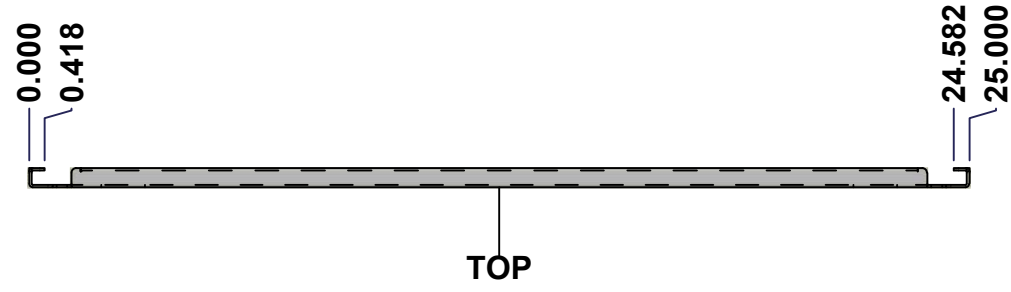

| No. | Revisions | Date | By/Par |
|-----|-----------|------|--------|
|     |           |      |        |
|     |           |      |        |
|     |           |      |        |
|     |           |      |        |
|     |           |      |        |

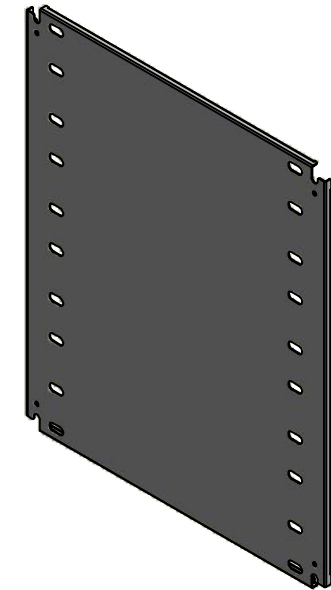

Isometric View



Tél: (450) 979-4373  
Fax: (450) 979-4626  
[www.exmweb.com](http://www.exmweb.com)

Flatness  
Aplatissement

Max 3.0mm

Projection

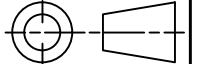

|   |                       |
|---|-----------------------|
| Customer Client   | Date                  |
| Drawn By / Dessiné Par: BoxCad: BoxCad                        | Date: 2022-09-15      |
| Material / Matière: 14 Ga Cold Rolled A1008 CS Type B (1.7mm) |                       |
| Color / Couleur: White RAL9003                                | Finish / Fini: Smooth |

|   |             |
|---|-------------|
| Description: 1412BTCU 30.625" x 28" Right Inner Panel | Detail Rev. |
|---|-------------|

|   |        |         |
|---|--------|---------|
| Part Number / Numéro Pièce: 1412BTCU081205IP2 | Rev. 0 | 12 / 13 |
|---|--------|---------|

SEE BILL OF MATERIAL ON LAST PAGE

This drawing is confidential and must not be reproduced or used without the consent of EXM

Ce dessin est confidentiel et ne doit pas être reproduit ou utilisé sans le consentement de EXM

| No. | Revisions | Date | By/Par |
|-----|-----------|------|--------|
|     |           |      |        |
|     |           |      |        |
|     |           |      |        |
|     |           |      |        |
|     |           |      |        |

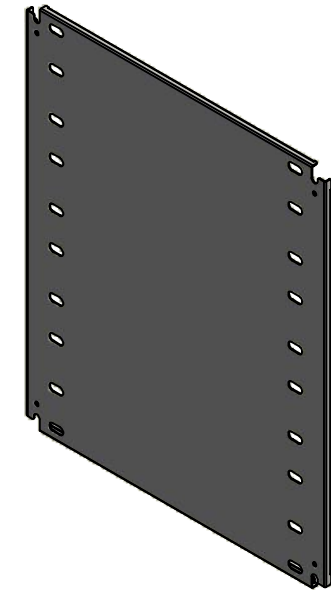

Isometric View

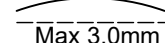

|  |                       |   |
|--|-----------------------|---|
|  Tél: (450) 979-4373<br>Fax: (450) 979-4626<br><a href="http://www.exmweb.com">www.exmweb.com</a> |                       | Flatness<br>Aplatissement<br><br>Max 3.0mm |
| Customer Client  |                       | Date  |
| Drawn By / Dessiné Par: BoxCad: BoxCad   |                       | Date: 2022-09-15  |
| Material / Matière: 14 Ga Cold Rolled A1008 CS Type B (1.7mm)  |                       |   |
| Color / Couleur: White RAL9003   | Finish / Fini: Smooth |   |
| Description: 1412BTCU 30.625" x 28" Right Inner Panel  |                       | Detail Rev.   |
| Part Number / Numéro Pièce: <b>1412BTCU081205IP2</b>   |                       | Rev. 13<br><b>0</b>   |

| Qty        | Part Number         | Rev | Description                                   |
|------------|---------------------|-----|---|
| 1          | STK-P-02401S        | 0   | Powder Paint (White / Smooth)                 |
| 1          | 1412BTCU081205IP2-P | 0   | 1412BTCU 30.625" x 96" Right Inner Panel Part |
| Parts List |                     |     |   |