

This drawing is confidential and must not be reproduced or used without the consent of EXM

Ce dessin est confidentiel et ne doit pas être reproduit ou utilisé sans le consentement de EXM

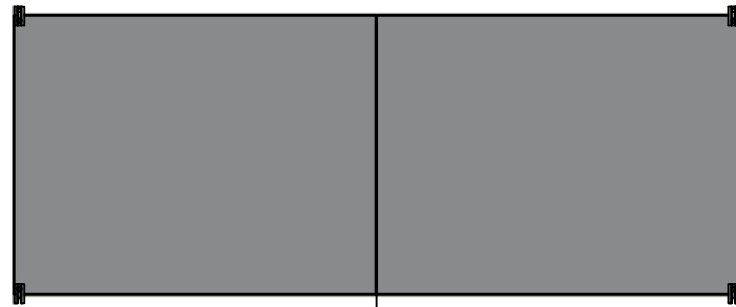

TOP



LEFT

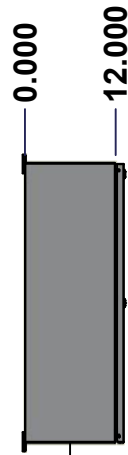

LEFT

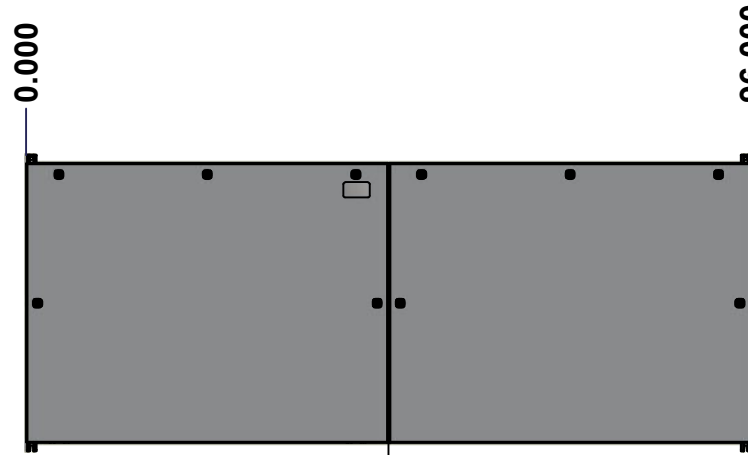

FRONT

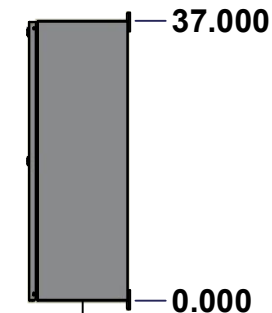

RIGHT



BOTTOM

No.	Revisions	Date	By/Par

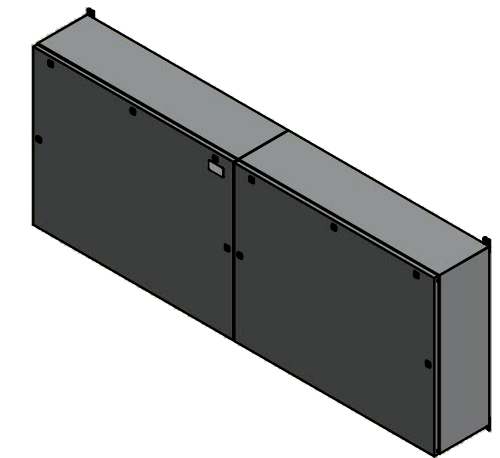

Isometric View



Tél: (450) 979-4373
 Fax: (450) 979-4626
www.exmweb.com

Flatness
Aplatissement

Max 3.0mm

Projection

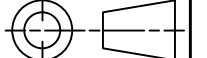

Customer Client	Date
Drawn By / Dessiné Par: BoxCad: BoxCad	Date: 10/24/2022
Material / Matière: 14 Ga Cold Rolled A1008 CS Type B (1.7mm)	
Color / Couleur: Asa-61 Grey	Finish / Fini: Smooth
Description: 1412BTCU 2000A - 4Wires x 96" Assembly	Detail Rev.
Part Number / Numéro Pièce: 1412BTCU082004DT	Rev. 0

SEE BILL OF MATERIAL ON LAST PAGE

This drawing is confidential and must not be reproduced or used without the consent of Eurobox

Ce dessin est confidentiel et ne doit pas être reproduit ou utilisé sans le consentement de Eurobox

STANDARD FEATURES ARE NOT LISTED IN THIS HOLE TABLE

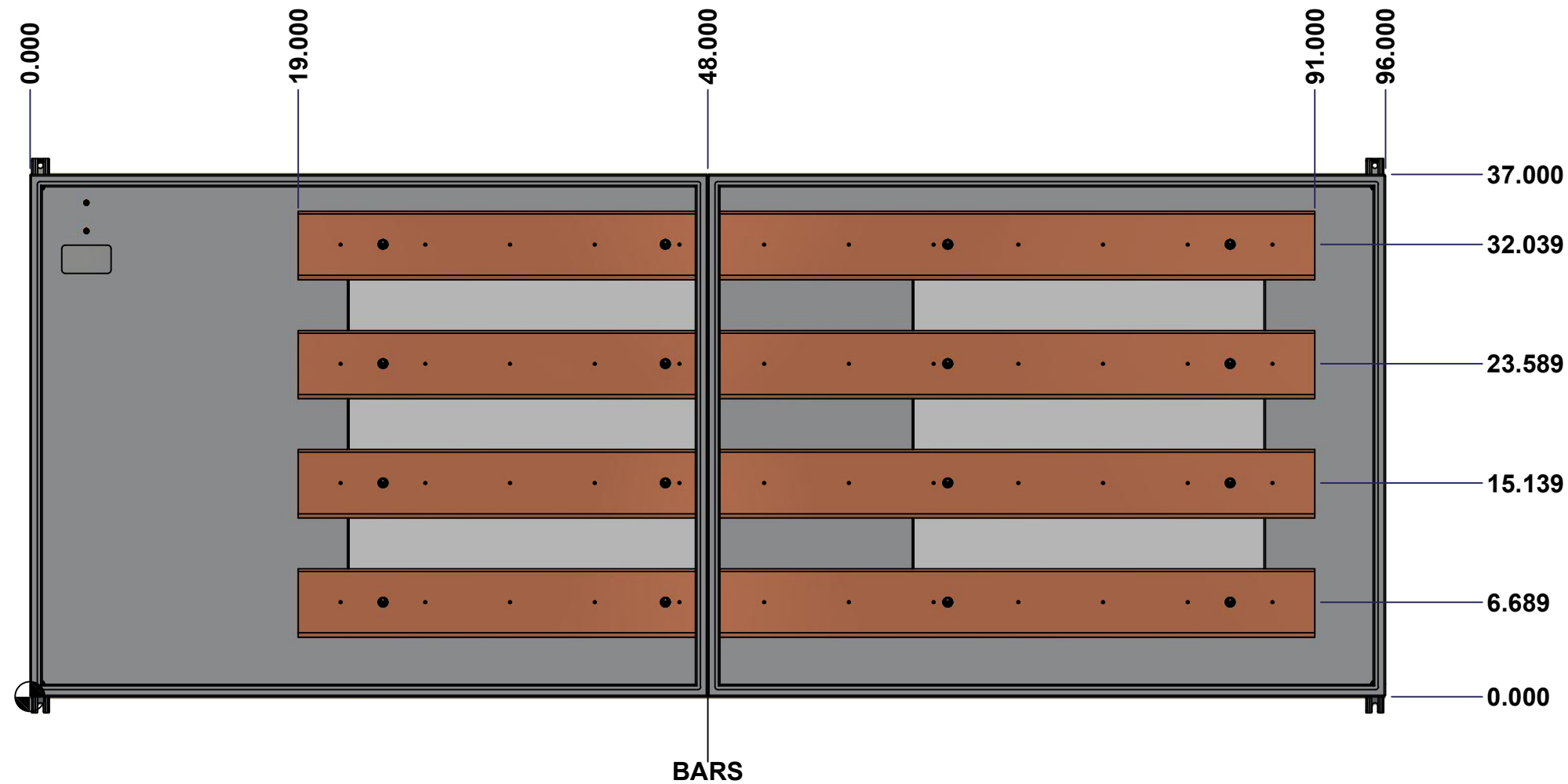

	Description		Status
	1412BTCU 2000A - 4Wires x 96" Assembly		(NULL)
Part Number		Rev.	2
Numéro Pièce		0	17
1412BTCU082004DT			

This drawing is confidential and must not be reproduced or used without the consent of EXM

Ce dessin est confidentiel et ne doit pas être reproduit ou utilisé sans le consentement de EXM

NOTE	
ITEM	DESCRIPTION
1	NEMA 4/12 Enclosure
2	C/W Standard ground studs on box and cover
3	W/O Standard door stiffener
4	C/W Special inner panel (Sold separately)
5	C/W Standard inner panel mounting studs

No.	Revisions	Date	By/Par

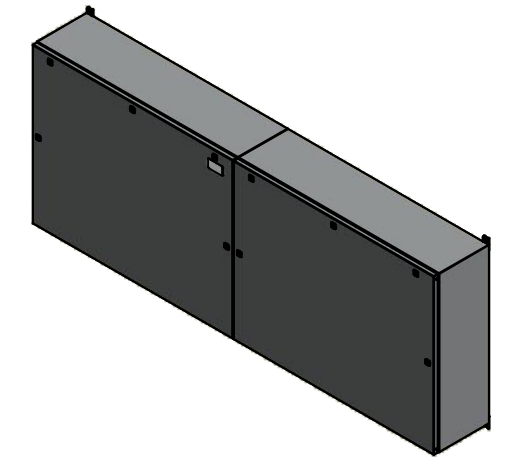

Isometric View



1	885 ESMF1	0	885 ESMF1 Mounting Feet Kit
1	1412BTCU082004DTIP2	0	1412BTCU 29.975" x 28" Right Inner Panel
1	1412BTCU082004DTBAR 1-P	0	Rounded Edge Copper Bar 1/2" x 5"
1	1412BTCU082004DTBAR 2-P	0	Rounded Edge Copper Bar 1/2" x 5"
1	1412BTCU082004DTBAR 3-P	0	Rounded Edge Copper Bar 1/2" x 5"
1	1412BTCU082004DTBAR 4-P	0	Rounded Edge Copper Bar 1/2" x 5"
1	1412BTCU082004DTIP1	0	1412BTCU 29.975" x 65" Inner Panel
16	STK-A-67400	0	Buss Bar Insulator Kit
1	STK-K-01800	5	5412 ES Accessory Kit
8	STK-Q-04050-07	7	M6 x 7mm Hexagon Socket Head Machine Screw with Nyseal
24	STK-Q-07310	2	Flange Lock Nut M8
8	STK-Q-07610	8	M8 Plastic Spacer 22.2mm
1	1412BTCU082004DTB	0	1412BTCU 37" x 96" x 12" Body
1	1412BTCU082004DTC	0	1412BTCU 37" x 96" Cover

PACKING		
ITEM	QTY	DESCRIPTION
Cardboard sleeve	2	Top and Bottom
Cardboard strip	2	Between back of enclosure and inner panel
Plastic bag	1	To protect cover surface and inside gasket
Cardboard corner	4	To reinforced for the plastic strap tightening
Plastic strap - Black	2	To Squeeze 2 cardboard sleeve together
Packaging label	3	White label with PN
Plastic strap- Green	2	To secure the enclosure to the wood pallet
Wood Pallet	1	2" deeper and 3" larger than enclosure size

Qty	Part Number	Rev	Description
Parts List			

	Tél: (450) 979-4373 Fax: (450) 979-4626 www.exmweb.com	Flatness Aplatissement Max 3.0mm
	Projection 	Customer Client Date
Drawn By Dessiné Par BoxCad: BoxCad	Date 10/24/2022	Material Matière 14 Ga Cold Rolled A1008 CS Type B (1.7mm)
Color Couleur Asa-61 Grey	Finish Fini Smooth	Description 1412BTCU 2000A - 4Wires x 96" Assembly
Part Number Numéro Pièce 1412BTCU082004DT	Rev. 0	Detail Rev. 3 17

This drawing is confidential and must not be reproduced or used without the consent of EXM

Ce dessin est confidentiel et ne doit pas être reproduit ou utilisé sans le consentement de EXM



TOP



BACK



BOTTOM

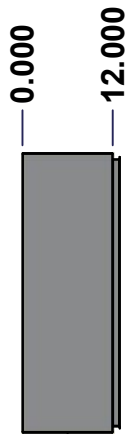

LEFT

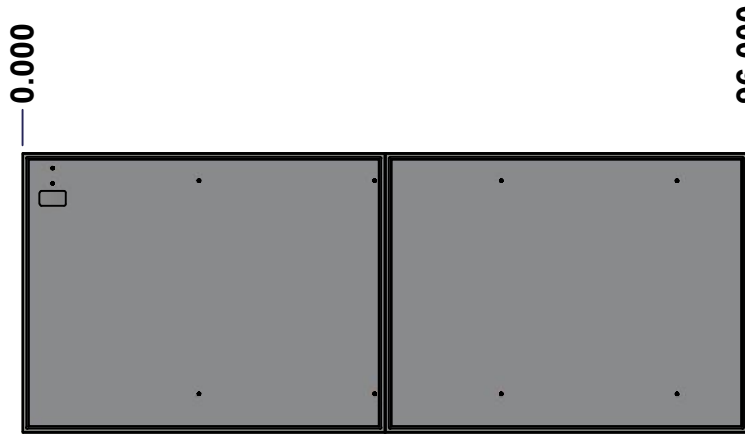

FRONT

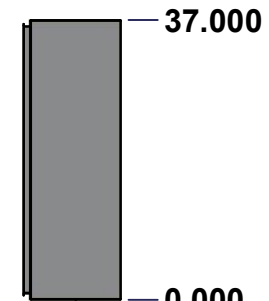

RIGHT

No.	Revisions	Date	By/Par

Isometric View

Tél: (450) 979-4373 Fax: (450) 979-4626 www.exmweb.com		Flatness Aplatissement Max 3.0mm Projection
Customer Client	Date	
Drawn By / Dessiné Par: BoxCad: BoxCad	Date: 10/24/2022	
Material / Matière: 14 Ga Cold Rolled A1008 CS Type B (1.7mm)		
Color / Couleur: Asa-61 Grey	Finish / Fini: Smooth	
Description: 1412BTCU 37" x 96" x 12" Body	Detail Rev.	
Part Number / Numéro Pièce: 1412BTCU082004DTB	Rev. 0	4 / 17

SEE BILL OF MATERIAL ON LAST PAGE

This drawing is confidential and must not be reproduced or used without the consent of Eurobox

Ce dessin est confidentiel et ne doit pas être reproduit ou utilisé sans le consentement de Eurobox

STANDARD FEATURES ARE NOT LISTED IN THIS HOLE TABLE

HOLE TABLE - BACK VIEW (CUSTOM FEATURE ONLY)

CUT-OUT	XDIM	YDIM	DESCRIPTION
1	92.000	35.000	GND STUD M8 x 35mm (Inside)
2	92.000	33.000	GND STUD M8 x 35mm (Inside)
3	9.375	33.350	IP STUD M8 x 35mm (Inside)
4	32.625	33.350	IP STUD M8 x 35mm (Inside)
5	9.375	5.125	IP STUD M8 x 35mm (Inside)
6	32.625	5.125	IP STUD M8 x 35mm (Inside)
7	49.375	33.350	IP STUD M8 x 35mm (Inside)
8	72.625	33.350	IP STUD M8 x 35mm (Inside)
9	49.375	5.125	IP STUD M8 x 35mm (Inside)
10	72.625	5.125	IP STUD M8 x 35mm (Inside)

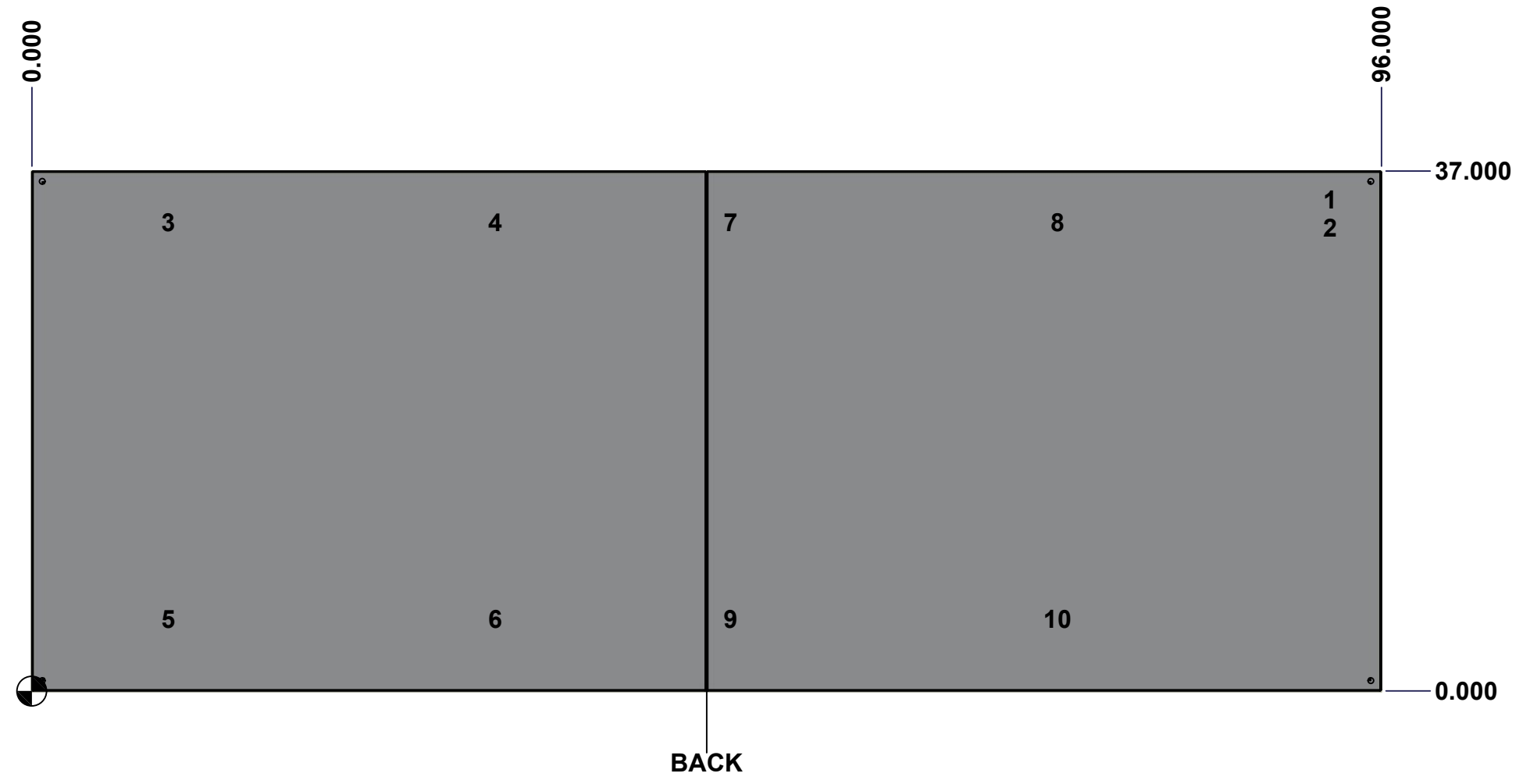

	Description		Status
	1412BTCU 37" x 96" x 12" Body		(NULL)
Part Number Numéro Pièce		Rev.	5
1412BTCU082004DTB		0	17

This drawing is confidential and must not be reproduced or used without the consent of EXM

Ce dessin est confidentiel et ne doit pas être reproduit ou utilisé sans le consentement de EXM

No.	Revisions	Date	By/Par

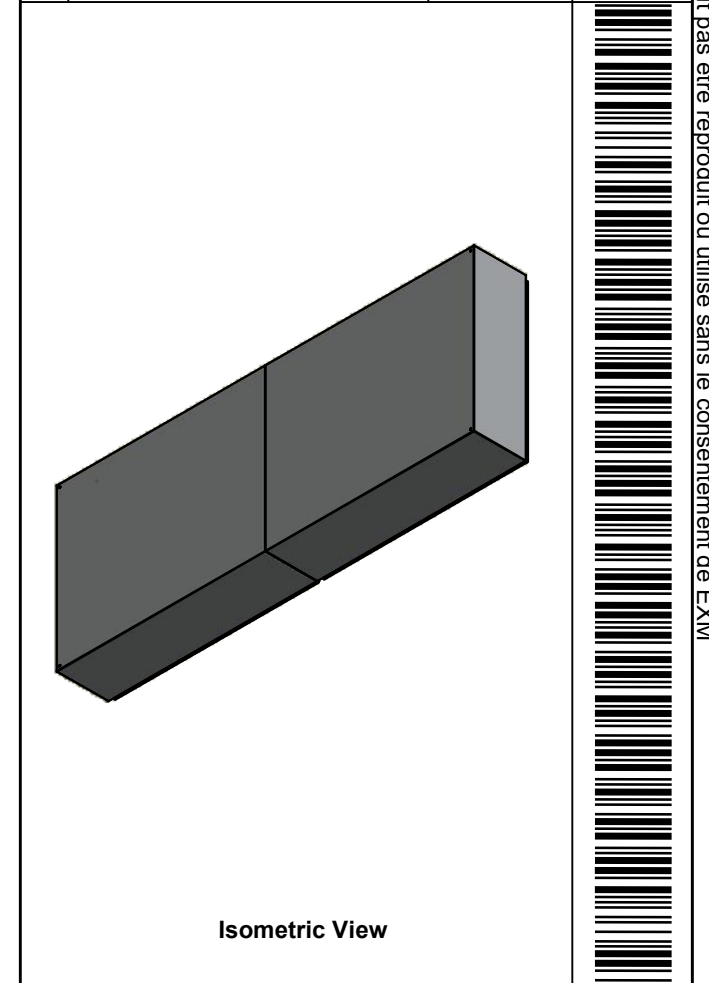

 Tél: (450) 979-4373
 Fax: (450) 979-4626
www.exmweb.com

Flatness
Aplatissement
 Max 3.0mm
Projection

Customer Client	Date
Drawn By / Dessiné Par: BoxCad: BoxCad	Date: 10/24/2022
Material / Matière: 14 Ga Cold Rolled A1008 CS Type B (1.7mm)	

Color / Couleur: Asa-61 Grey	Finish / Fini: Smooth
Description: 1412BTCU 37" x 96" x 12" Body	Detail Rev.

Part Number / Numéro Pièce: 1412BTCU082004DTB	Rev. 0	6
--	---------------	---

Qty	Part Number	Rev	Description
1	STK-P-02400S	0	Powder Paint (Asa-61 Grey / Smooth)
1	1412BTCU082004DTB-P	0	1412BTCU 37" x 96" x 12" Body Part
1	1412BTCU082004DTE-P	0	1412BTCU 37" x 96" x 12" Right Body Part
1	STK-G-00701	0	1" x 1/4" Self-Adhesive Neoprene Gasket
10	STK-Q-00260	1	M6 x 13mm Carriage Bolt
10	STK-Q-07220	1	M6 Nylon Insert Lock Nut
10	STK-Q-16005	1	Stud M8 x 35 (No Paint Cap Required)
2	STK-Q-16080	0	Ground Stud M6 x 16mm
1	STK-S-00100	0	3.5" x 2" Silver Milar Flexcon Sticker
Parts List			

This drawing is confidential and must not be reproduced or used without the consent of Eurobox

Ce dessin est confidentiel et ne doit pas être reproduit ou utilisé sans le consentement de Eurobox

STANDARD FEATURES ARE NOT LISTED IN THIS HOLE TABLE			
HOLE TABLE - FRONT VIEW (CUSTOM FEATURE ONLY)			
CUT-OUT	XDIM	YDIM	DESCRIPTION
1	69.000	2.500	RND Ø0.201 THREAD 1/4-20 UNC
2	63.000	2.500	RND Ø0.201 THREAD 1/4-20 UNC
3	57.000	2.500	RND Ø0.201 THREAD 1/4-20 UNC
4	51.000	2.500	RND Ø0.201 THREAD 1/4-20 UNC
5	45.000	2.500	RND Ø0.201 THREAD 1/4-20 UNC
6	39.000	2.500	RND Ø0.201 THREAD 1/4-20 UNC
7	33.000	2.500	RND Ø0.201 THREAD 1/4-20 UNC
8	27.000	2.500	RND Ø0.201 THREAD 1/4-20 UNC
9	21.000	2.500	RND Ø0.201 THREAD 1/4-20 UNC
10	15.000	2.500	RND Ø0.201 THREAD 1/4-20 UNC
11	9.000	2.500	RND Ø0.201 THREAD 1/4-20 UNC
12	3.000	2.500	RND Ø0.201 THREAD 1/4-20 UNC

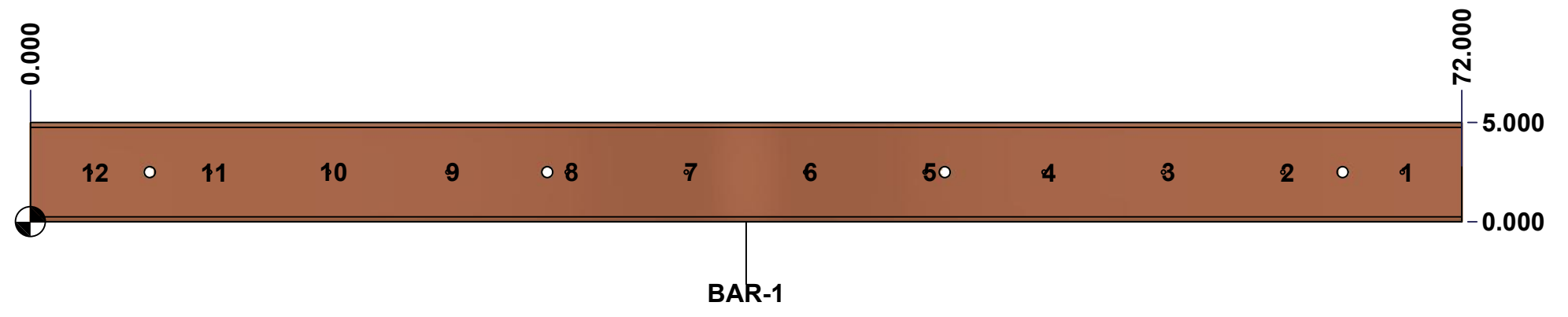

	Description	Status
	Rounded Edge Copper Bar 1/2" x 5"	(NULL)
	Part Number Numéro Pièce	Rev.
	1412BTCU082004DTBAR1-P	7
	0	17

This drawing is confidential and must not be reproduced or used without the consent of Eurobox

Ce dessin est confidentiel et ne doit pas être reproduit ou utilisé sans le consentement de Eurobox

STANDARD FEATURES ARE NOT LISTED IN THIS HOLE TABLE			
HOLE TABLE - FRONT VIEW (CUSTOM FEATURE ONLY)			
CUT-OUT	XDIM	YDIM	DESCRIPTION
1	69.000	2.500	RND Ø0.201 THREAD 1/4-20 UNC
2	63.000	2.500	RND Ø0.201 THREAD 1/4-20 UNC
3	57.000	2.500	RND Ø0.201 THREAD 1/4-20 UNC
4	51.000	2.500	RND Ø0.201 THREAD 1/4-20 UNC
5	45.000	2.500	RND Ø0.201 THREAD 1/4-20 UNC
6	39.000	2.500	RND Ø0.201 THREAD 1/4-20 UNC
7	33.000	2.500	RND Ø0.201 THREAD 1/4-20 UNC
8	27.000	2.500	RND Ø0.201 THREAD 1/4-20 UNC
9	21.000	2.500	RND Ø0.201 THREAD 1/4-20 UNC
10	15.000	2.500	RND Ø0.201 THREAD 1/4-20 UNC
11	9.000	2.500	RND Ø0.201 THREAD 1/4-20 UNC
12	3.000	2.500	RND Ø0.201 THREAD 1/4-20 UNC

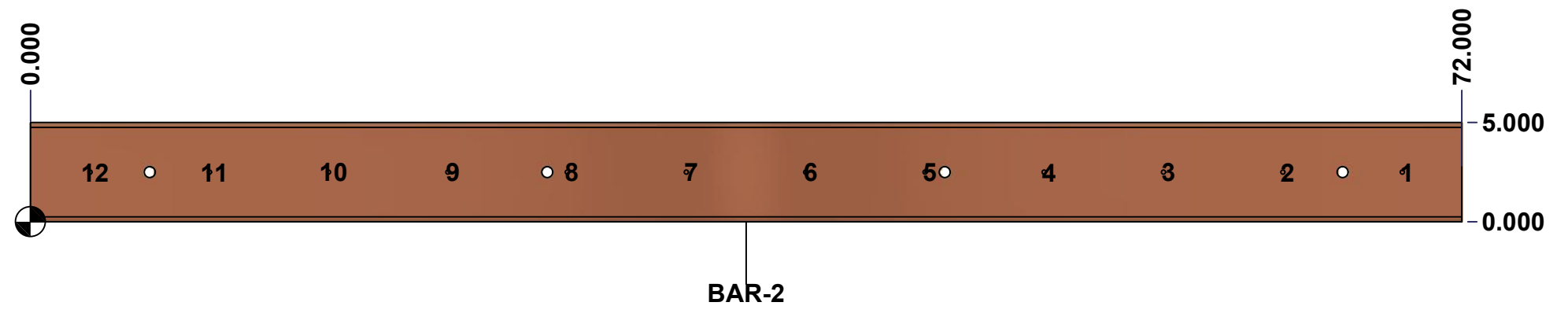

	Description	Status
	Rounded Edge Copper Bar 1/2" x 5"	(NULL)
	Part Number Numéro Pièce	Rev.
	1412BTCU082004DTBAR2-P	8
		0
		17

This drawing is confidential and must not be reproduced or used without the consent of Eurobox

Ce dessin est confidentiel et ne doit pas être reproduit ou utilisé sans le consentement de Eurobox

STANDARD FEATURES ARE NOT LISTED IN THIS HOLE TABLE			
HOLE TABLE - FRONT VIEW (CUSTOM FEATURE ONLY)			
CUT-OUT	XDIM	YDIM	DESCRIPTION
1	69.000	2.500	RND Ø0.201 THREAD 1/4-20 UNC
2	63.000	2.500	RND Ø0.201 THREAD 1/4-20 UNC
3	57.000	2.500	RND Ø0.201 THREAD 1/4-20 UNC
4	51.000	2.500	RND Ø0.201 THREAD 1/4-20 UNC
5	45.000	2.500	RND Ø0.201 THREAD 1/4-20 UNC
6	39.000	2.500	RND Ø0.201 THREAD 1/4-20 UNC
7	33.000	2.500	RND Ø0.201 THREAD 1/4-20 UNC
8	27.000	2.500	RND Ø0.201 THREAD 1/4-20 UNC
9	21.000	2.500	RND Ø0.201 THREAD 1/4-20 UNC
10	15.000	2.500	RND Ø0.201 THREAD 1/4-20 UNC
11	9.000	2.500	RND Ø0.201 THREAD 1/4-20 UNC
12	3.000	2.500	RND Ø0.201 THREAD 1/4-20 UNC

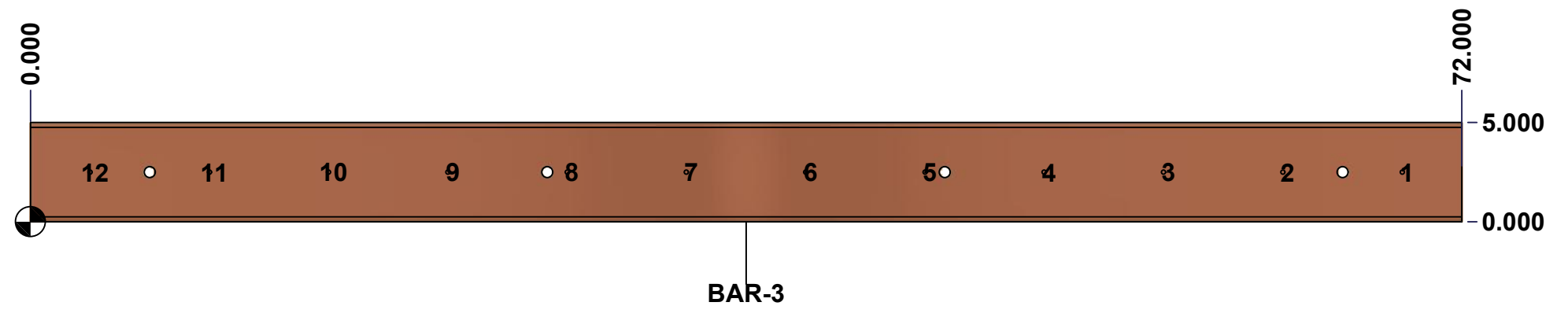

	Description	Status
	Rounded Edge Copper Bar 1/2" x 5"	(NULL)
	Part Number Numéro Pièce	Rev.
	1412BTCU082004DTBAR3-P	9
	0	17

This drawing is confidential and must not be reproduced or used without the consent of Eurobox

Ce dessin est confidentiel et ne doit pas être reproduit ou utilisé sans le consentement de Eurobox

STANDARD FEATURES ARE NOT LISTED IN THIS HOLE TABLE			
HOLE TABLE - FRONT VIEW (CUSTOM FEATURE ONLY)			
CUT-OUT	XDIM	YDIM	DESCRIPTION
1	69.000	2.500	RND Ø0.201 THREAD 1/4-20 UNC
2	63.000	2.500	RND Ø0.201 THREAD 1/4-20 UNC
3	57.000	2.500	RND Ø0.201 THREAD 1/4-20 UNC
4	51.000	2.500	RND Ø0.201 THREAD 1/4-20 UNC
5	45.000	2.500	RND Ø0.201 THREAD 1/4-20 UNC
6	39.000	2.500	RND Ø0.201 THREAD 1/4-20 UNC
7	33.000	2.500	RND Ø0.201 THREAD 1/4-20 UNC
8	27.000	2.500	RND Ø0.201 THREAD 1/4-20 UNC
9	21.000	2.500	RND Ø0.201 THREAD 1/4-20 UNC
10	15.000	2.500	RND Ø0.201 THREAD 1/4-20 UNC
11	9.000	2.500	RND Ø0.201 THREAD 1/4-20 UNC
12	3.000	2.500	RND Ø0.201 THREAD 1/4-20 UNC

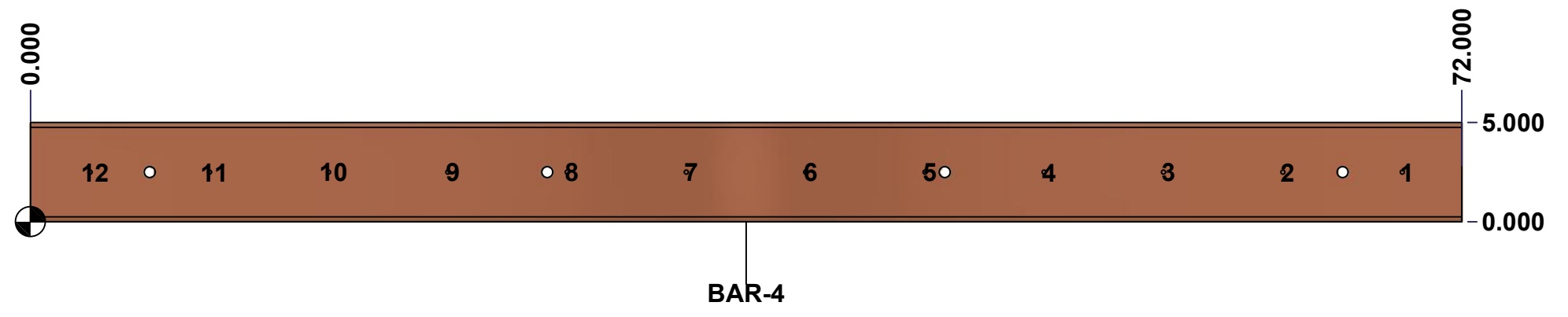

	Description	Status
	Rounded Edge Copper Bar 1/2" x 5"	(NULL)
	Part Number Numéro Pièce	Rev.
	1412BTCU082004DTBAR4-P	0
		10
		17

This drawing is confidential and must not be reproduced or used without the consent of EXM

Ce dessin est confidentiel et ne doit pas être reproduit ou utilisé sans le consentement de EXM



TOP

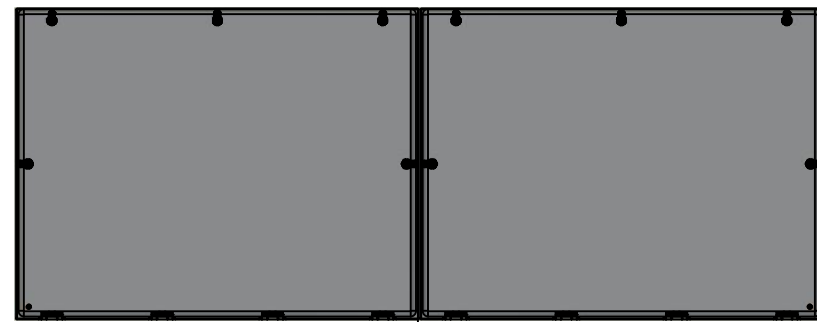

BACK



BOTTOM

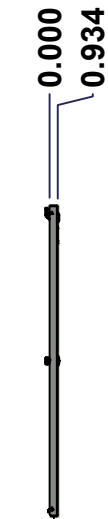

LEFT

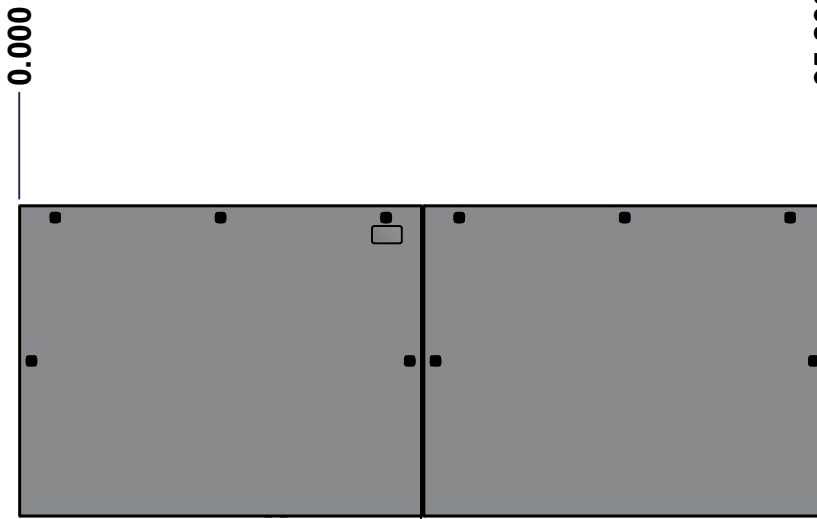

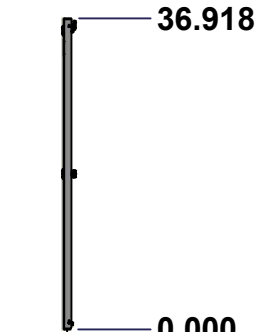

FRONT

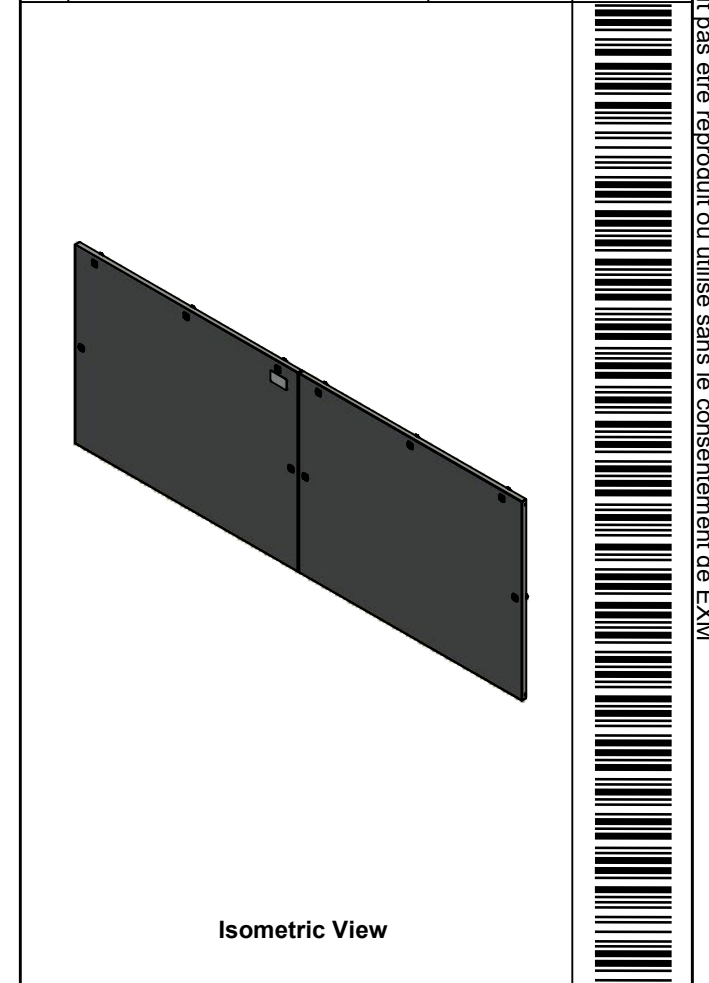

RIGHT

No.	Revisions	Date	By/Par

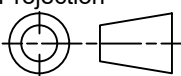

 Tél: (450) 979-4373 Fax: (450) 979-4626 www.exmweb.com		Flatness Aplatissement Max 3.0mm Projection 
Customer Client	Date	
Drawn By Dessiné Par	BoxCad: BoxCad	Date 10/24/2022
Material Matière	14 Ga Cold Rolled A1008 CS Type B (1.7mm)	
Color Couleur	Asa-61 Grey	Finish Fini Smooth
Description 1412BTCU 37" x 96" Cover		Detail Rev.
Part Number Numéro Pièce	Rev. 0	11 / 17

SEE BILL OF MATERIAL ON LAST PAGE

1412BTCU082004DTC

This drawing is confidential and must not be reproduced or used without the consent of Eurobox

Ce dessin est confidentiel et ne doit pas être reproduit ou utilisé sans le consentement de Eurobox

STANDARD FEATURES ARE NOT LISTED IN THIS HOLE TABLE			
HOLE TABLE - FRONT VIEW (CUSTOM FEATURE ONLY)			
CUT-OUT	XDIM	YDIM	DESCRIPTION
1	1.500	1.486	GND STUD M6 x 16mm (Inside)
2	94.303	1.486	GND STUD M6 x 16mm (Inside)
3	94.379	18.459	LOCK 880 SCQ4-SL @ 0.0°
4	49.424	18.459	LOCK 880 SCQ4-SL @ 180.0°
5	46.379	18.459	LOCK 880 SCQ4-SL @ 0.0°
6	1.424	18.459	LOCK 880 SCQ4-SL @ 180.0°
7	91.553	35.494	LOCK 880 SCQ4-SL @ 90.0°
8	71.902	35.494	LOCK 880 SCQ4-SL @ 90.0°
9	52.250	35.494	LOCK 880 SCQ4-SL @ 90.0°
10	43.553	35.494	LOCK 880 SCQ4-SL @ 90.0°
11	23.902	35.494	LOCK 880 SCQ4-SL @ 90.0°
12	4.250	35.494	LOCK 880 SCQ4-SL @ 90.0°

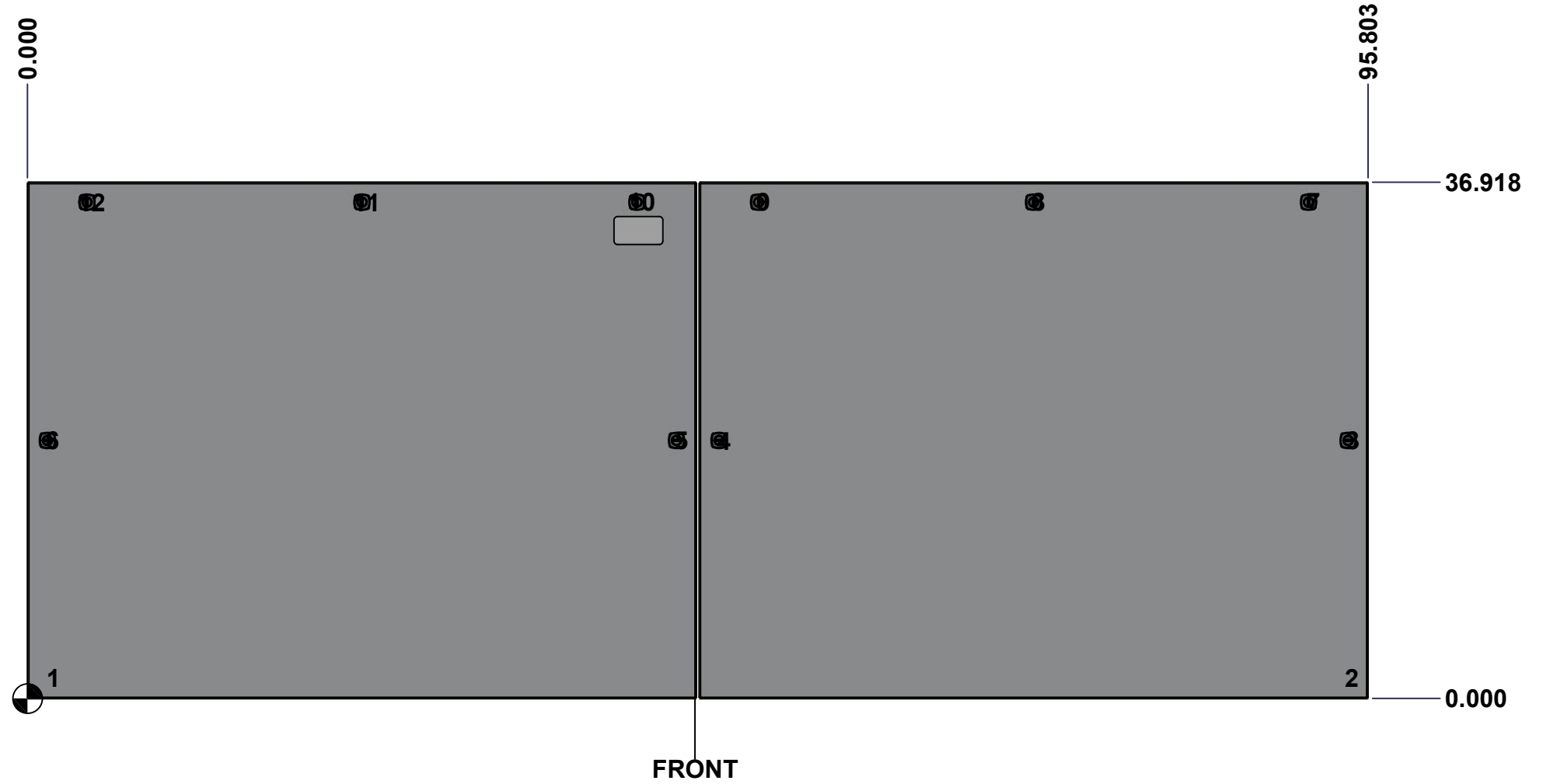

	Description	Status	
	1412BTCU 37" x 96" Cover	(NULL)	
	Part Number Numéro Pièce	Rev.	12
	1412BTCU082004DTC	0	17

This drawing is confidential and must not be reproduced or used without the consent of EXM

Ce dessin est confidentiel et ne doit pas être reproduit ou utilisé sans le consentement de EXM

No.	Revisions	Date	By/Par

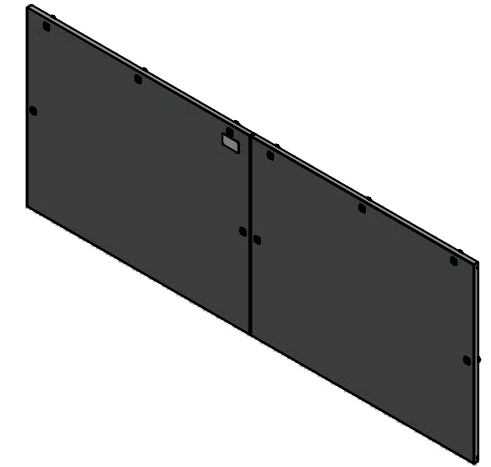

Isometric View

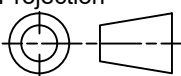

 Tél: (450) 979-4373 Fax: (450) 979-4626 www.exmweb.com	Flatness Aplatissement	Max 3.0mm
	Projection	
Customer Client	Date	
Drawn By Dessiné Par	BoxCad: BoxCad	Date 10/24/2022
Material Matière	14 Ga Cold Rolled A1008 CS Type B (1.7mm)	
Color Couleur	Asa-61 Grey	Finish Fini Smooth
Description	Detail Rev.	
1412BTCU 37" x 96" Cover		
Part Number Numéro Pièce	Rev. 0	13 / 17
1412BTCU082004DTC		

Qty	Part Name	Rev	Description
2	1412BTCU082004DTG	0	1412BTCU 37" x 96" Cover Gasket
1	STK-P-02400S	0	Powder Paint (Asa-61 Grey / Smooth)
8	STK-K-09800	10	5412 ES Hinge with 2 Captive Hinge Pins
2	STK-Q-16080	0	Ground Stud M6 x 16mm
1	STK-S-00100	0	3.5" x 2" Silver Milar Flexcon Sticker
1	1412BTCU082004DTC-P	0	1412BTCU 37" x 96" Cover Part
1	1412BTCU082004DTF-P	0	1412BTCU 37" x 96" Right Cover Part
10	880 SCQ4-SL	6	5412 ES 1/4 Turn Lock
Parts List			

This drawing is confidential and must not be reproduced or used without the consent of EXM

Ce dessin est confidentiel et ne doit pas être reproduit ou utilisé sans le consentement de EXM



TOP

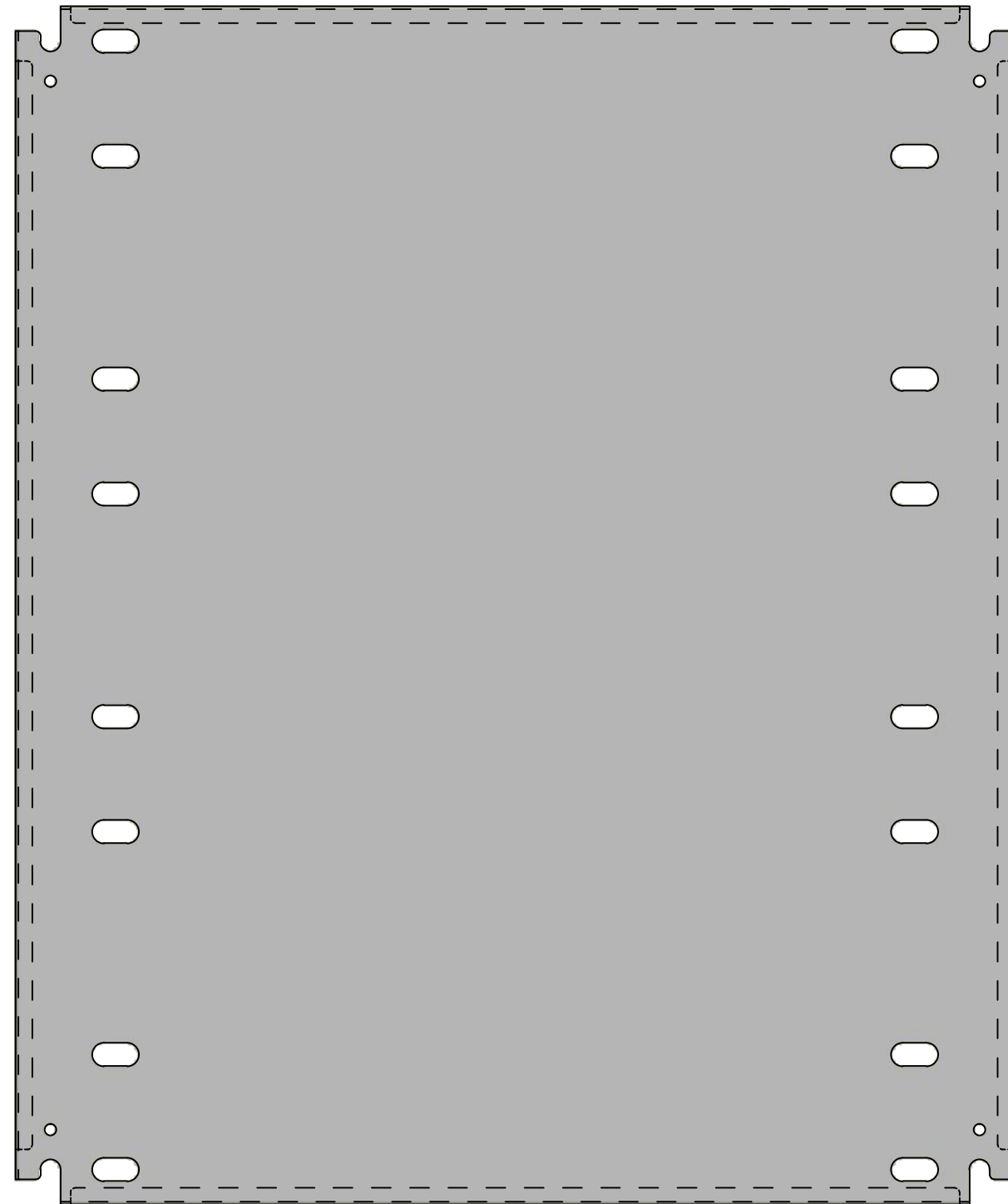

FRONT

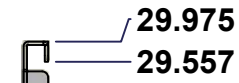

RIGHT

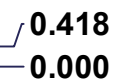

SEE BILL OF MATERIAL ON LAST PAGE

No.	Revisions	Date	By/Par

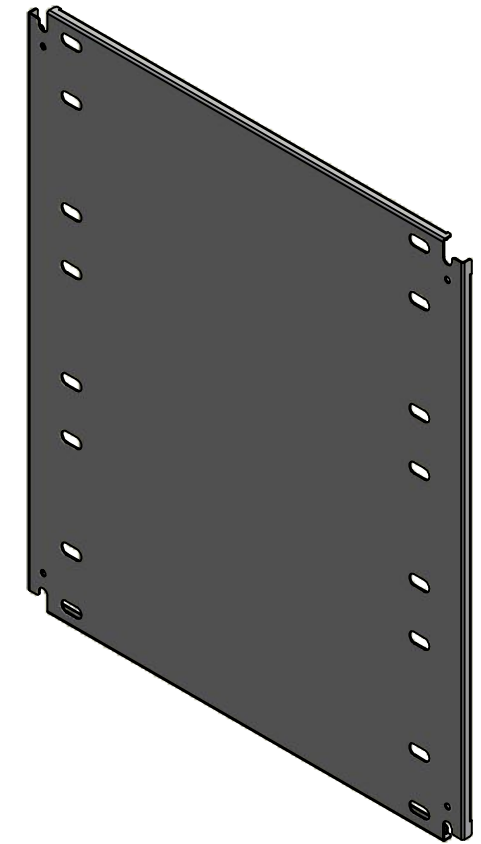

Isometric View



Tél: (450) 979-4373
 Fax: (450) 979-4626
www.exmweb.com

Flatness
Aplatissement

Max 3.0mm

Projection

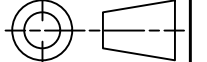

Customer Client	Date
Drawn By / Dessiné Par: BoxCad: BoxCad	Date: 10/24/2022
Material / Matière: 14 Ga Cold Rolled A1008 CS Type B (1.7mm)	

Color / Couleur: White RAL9003	Finish / Fini: Smooth
--------------------------------	-----------------------

Description: 1412BTCU 29.975" x 65" Inner Panel	Detail Rev.
---	-------------

Part Number / Numéro Pièce: 1412BTCU082004DTIP1	Rev. 0	14 / 17
---	--------	---------

This drawing is confidential and must not be reproduced or used without the consent of EXM

Ce dessin est confidentiel et ne doit pas être reproduit ou utilisé sans le consentement de EXM

No.	Revisions	Date	By/Par

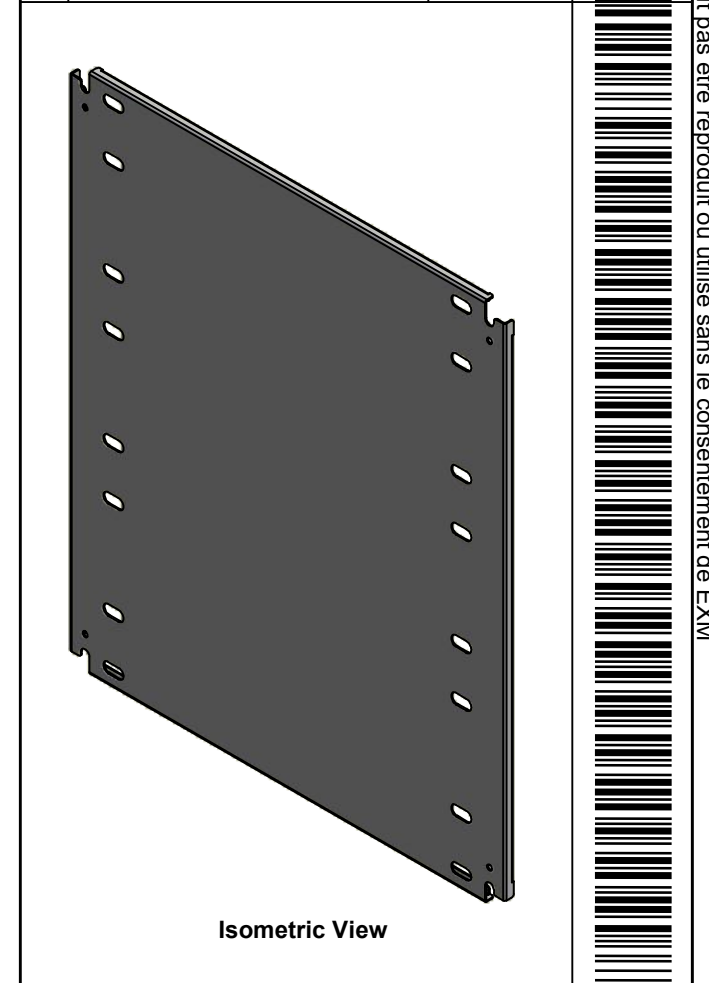

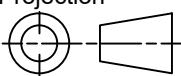
 Tél: (450) 979-4373 Fax: (450) 979-4626 www.exmweb.com		Flatness Aplatissement Max 3.0mm Projection 
Customer Client	Date	
Drawn By Dessiné Par	BoxCad: BoxCad	Date 10/24/2022
Material Matière	14 Ga Cold Rolled A1008 CS Type B (1.7mm)	
Color Couleur	White RAL9003	Finish Fini Smooth
Description		Detail Rev.
1412BTCU 29.975" x 65" Inner Panel		
Part Number Numéro Pièce	Rev.	15
1412BTCU082004DTIP1	0	17

Qty	Part Number	Rev	Description
1	STK-P-02401S	0	Powder Paint (White / Smooth)
1	1412BTCU082004DTIP1-P	0	1412BTCU 29.975" x 96" Inner Panel Part
Parts List			

This drawing is confidential and must not be reproduced or used without the consent of EXM

Ce dessin est confidentiel et ne doit pas être reproduit ou utilisé sans le consentement de EXM

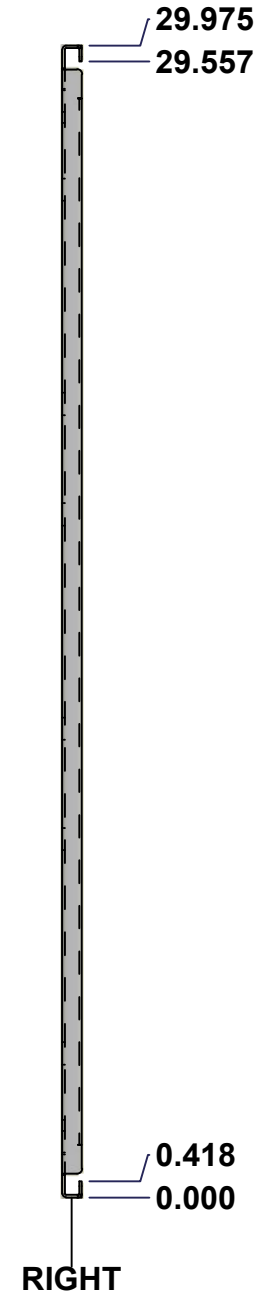
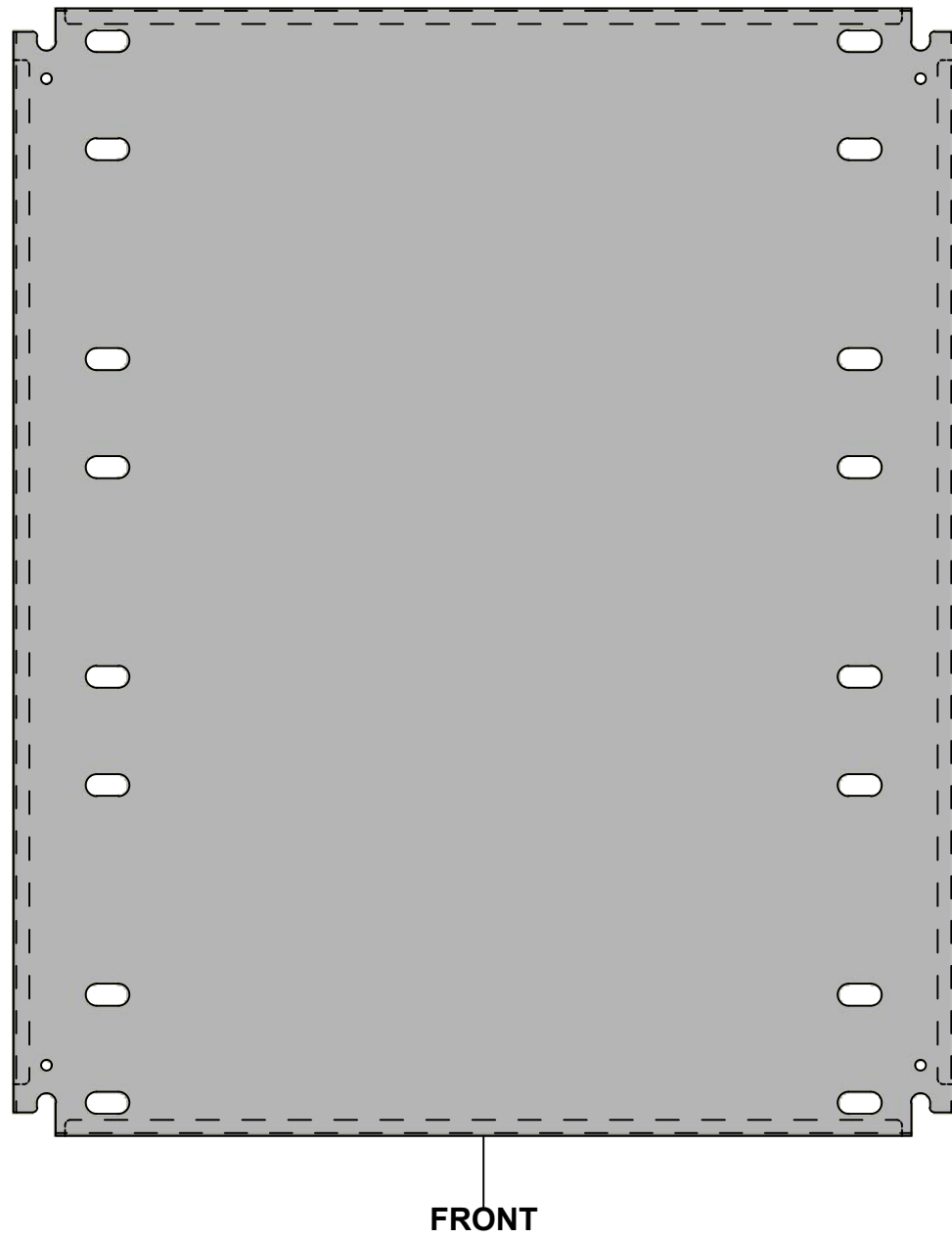
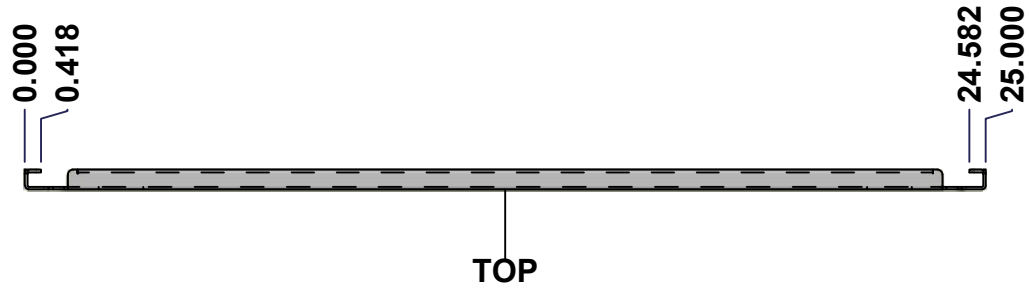

No.	Revisions	Date	By/Par

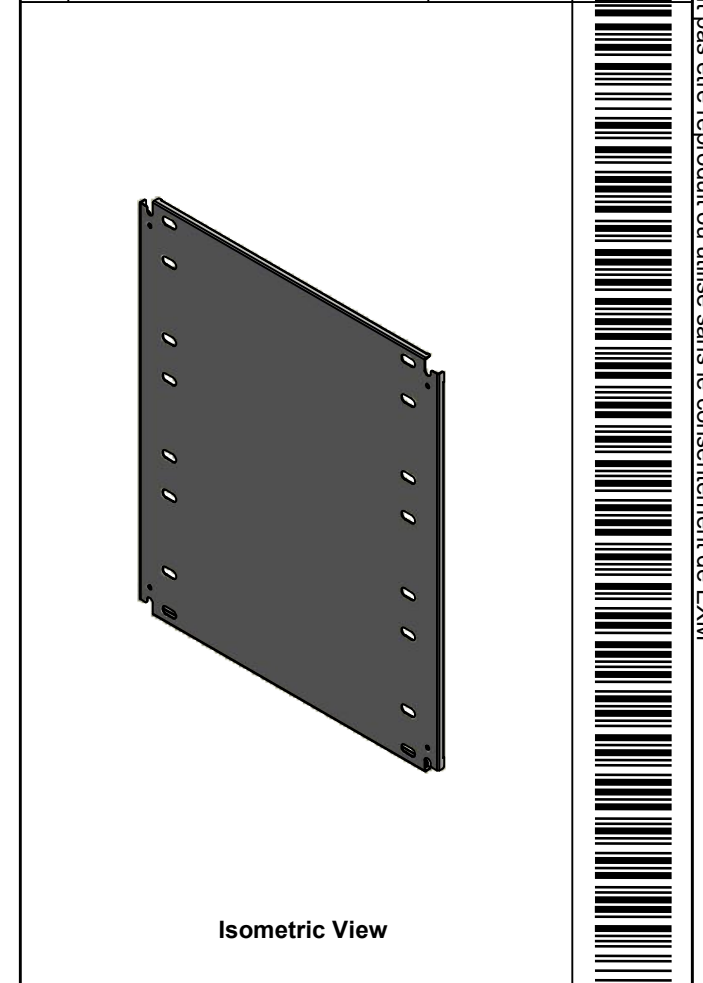

Tél: (450) 979-4373 Fax: (450) 979-4626 www.exmweb.com		Flatness Aplatissement Max 3.0mm Projection
Customer Client	Date	
Drawn By Dessiné Par	BoxCad: BoxCad	Date 10/24/2022
Material Matière	14 Ga Cold Rolled A1008 CS Type B (1.7mm)	
Color Couleur	White RAL9003	Finish Fini Smooth
Description 1412BTCU 29.975" x 28" Right Inner Panel		Detail Rev.
Part Number Numéro Pièce	1412BTCU082004DTIP2	Rev. 16 0 17

SEE BILL OF MATERIAL ON LAST PAGE

This drawing is confidential and must not be reproduced or used without the consent of EXM

Ce dessin est confidentiel et ne doit pas être reproduit ou utilisé sans le consentement de EXM

No.	Revisions	Date	By/Par

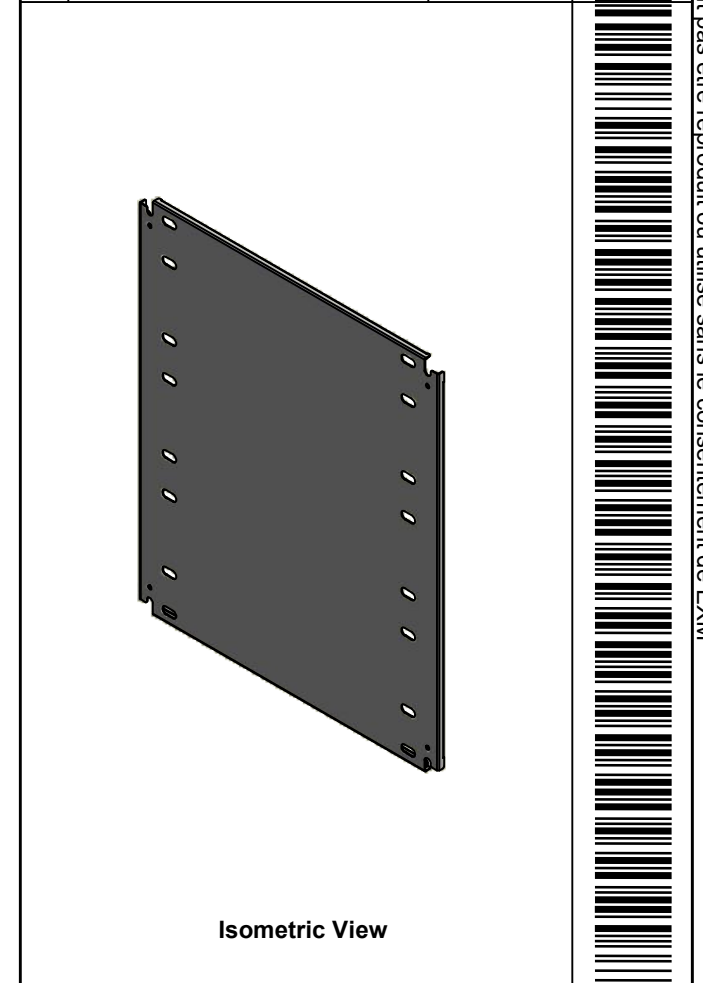

Isometric View

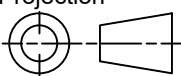

 Tél: (450) 979-4373 Fax: (450) 979-4626 www.exmweb.com		Flatness Aplatissement Max 3.0mm Projection 
Customer Client	Date	
Drawn By Dessiné Par	BoxCad: BoxCad	Date 10/24/2022
Material Matière	14 Ga Cold Rolled A1008 CS Type B (1.7mm)	
Color Couleur	White RAL9003	Finish Fini Smooth
Description		Detail Rev.
1412BTCU 29.975" x 28" Right Inner Panel		
Part Number Numéro Pièce	Rev. 0	17
1412BTCU082004DTIP2		17

Qty	Part Number	Rev	Description
1	STK-P-02401S	0	Powder Paint (White / Smooth)
1	1412BTCU082004DTIP2-P	0	1412BTCU 29.975" x 96" Right Inner Panel Part
Parts List			