

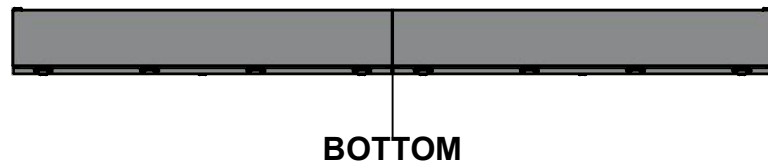

This drawing is confidential and must not be reproduced or used without the consent of EXM

Ce dessin est confidentiel et ne doit pas être reproduit ou utilisé sans le consentement de EXM

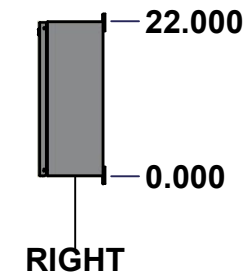
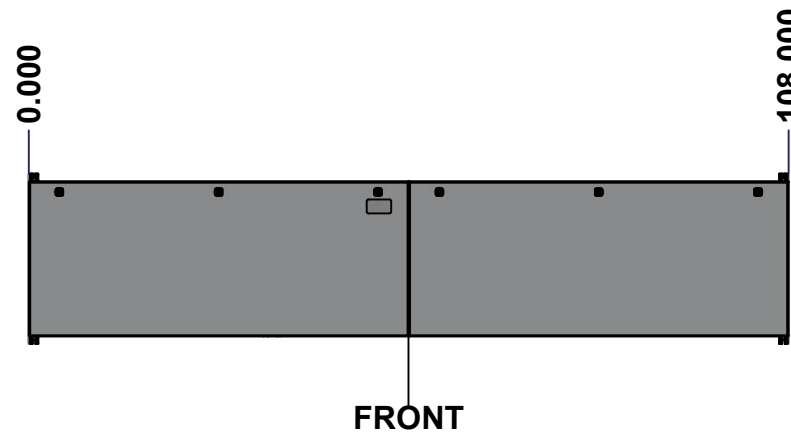
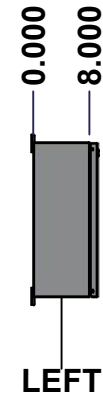
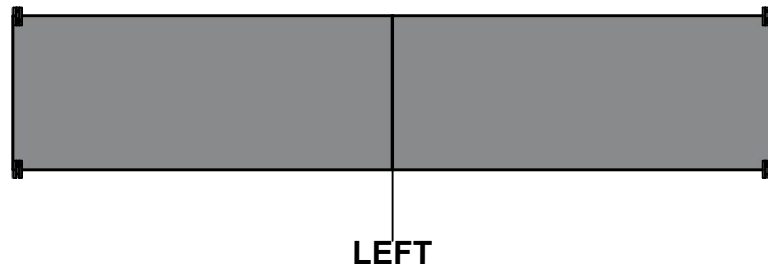
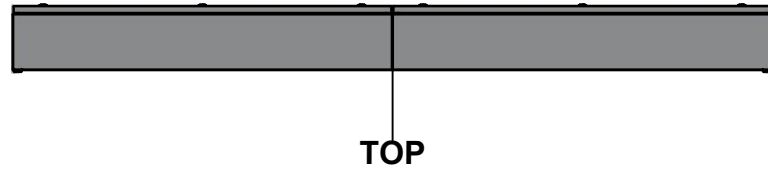
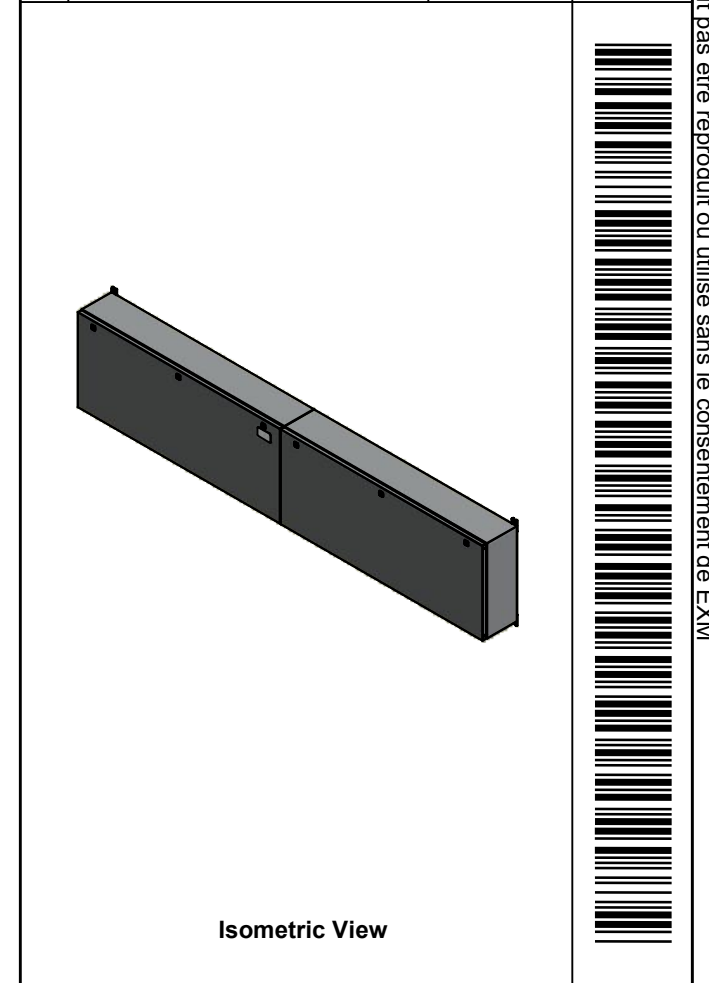

No.	Revisions	Date	By/Par

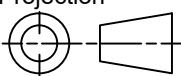

 Tél: (450) 979-4373 Fax: (450) 979-4626 <a href="http://www.exmweb.com">www.exmweb.com</a>		Flatness Aplatissement Max 3.0mm Projection 
Customer Client	Date	
Drawn By Dessiné Par	BoxCad: BoxCad	Date 2022-10-19
Material Matière	14 Ga Cold Rolled A1008 CS Type B (1.7mm)	
Color Couleur	Asa-61 Grey	Finish Fini Smooth
Description	Detail Rev.	
1412BTCU 225A - 4Wires x 108" Assembly		
Part Number Numéro Pièce	Rev.	1
<b>1412BTCU09204DT</b>	<b>0</b>	17

**SEE BILL OF MATERIAL ON LAST PAGE**

This drawing is confidential and must not be reproduced or used without the consent of Eurobox

**STANDARD FEATURES ARE NOT LISTED IN THIS HOLE TABLE**

Ce dessin est confidentiel et ne doit pas être reproduit ou utilisé sans le consentement de Eurobox

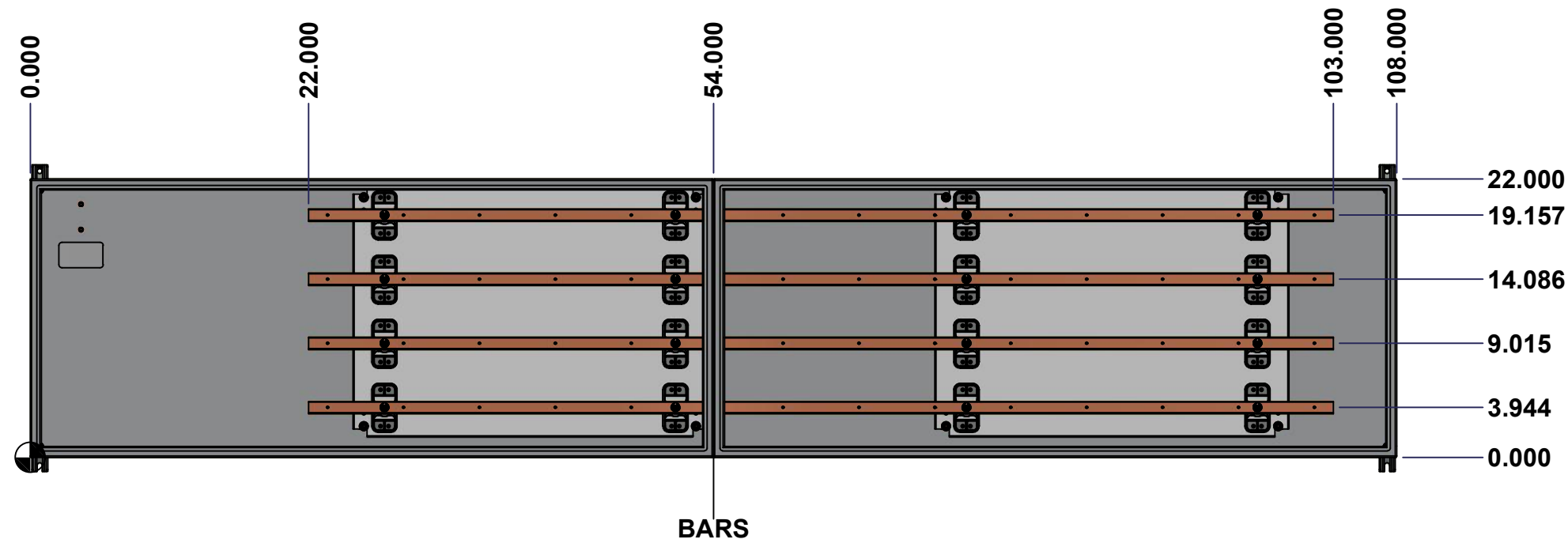

	Description 1412BTCU 225A - 4Wires x 108" Assembly	Status (NULL)
	Part Number Numéro Pièce <b>1412BTCU09204DT</b>	Rev. 2 <b>0</b>

This drawing is confidential and must not be reproduced or used without the consent of EXM

Ce dessin est confidentiel et ne doit pas être reproduit ou utilisé sans le consentement de EXM

NOTE	
ITEM	DESCRIPTION
1	NEMA 4/12 Enclosure
2	C/W Standard ground studs on box and cover
3	W/O Standard door stiffener
4	C/W Special inner panel (Sold separately)
5	C/W Standard inner panel mounting studs

No.	Revisions	Date	By/Par

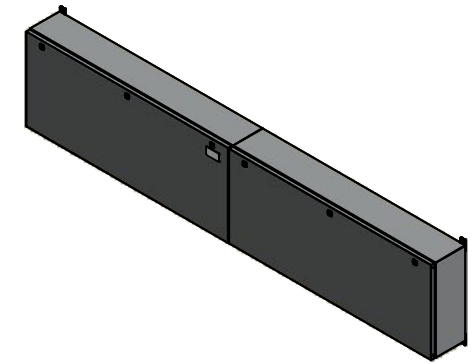

Isometric View

1	885 ESMF1	0	885 ESMF1 Mounting Feet Kit
1	1412BTCU09204DTIP2	0	1412BTCU 19.838" x 28" Right Inner Panel
1	1412BTCU09204DTBAR1-P	0	Rounded Edge Copper Bar 1/8" x 1"
1	1412BTCU09204DTBAR2-P	0	Rounded Edge Copper Bar 1/8" x 1"
1	1412BTCU09204DTBAR3-P	0	Rounded Edge Copper Bar 1/8" x 1"
1	1412BTCU09204DTBAR4-P	0	Rounded Edge Copper Bar 1/8" x 1"
1	1412BTCU09204DTIP1	0	1412BTCU 19.838" x 28" Left Inner Panel
16	STK-A-67400	0	Buss Bar Insulator Kit
1	STK-K-01800	5	5412 ES Accessory Kit
8	STK-Q-04050-07	7	M6 x 7mm Hexagon Socket Head Machine Screw with Nyseal
24	STK-Q-07310	2	Flange Lock Nut M8
8	STK-Q-07610	8	M8 Plastic Spacer 22.2mm
1	1412BTCU09204DTB	0	1412BTCU 22" x 108" x 8" Body
1	1412BTCU09204DTC	0	1412BTCU 22" x 108" Cover
Qty	Part Number	Rev	Description
Parts List			

PACKING		
ITEM	QTY	DESCRIPTION
Cardboard sleeve	2	Top and Bottom
Cardboard strip	2	Between back of enclosure and inner panel
Plastic bag	1	To protect cover surface and inside gasket
Cardboard corner	4	To reinforced for the plastic strap tightening
Plastic strap - Black	2	To Squeeze 2 cardboard sleeve together
Packaging label	3	White label with PN
Plastic strap- Green	2	To secure the enclosure to the wood pallet
Wood Pallet	1	2" deeper and 3" larger than enclosure size

	Tél: (450) 979-4373 Fax: (450) 979-4626 <a href="http://www.exmweb.com">www.exmweb.com</a>	Flatness Aplatissement Max 3.0mm Projection 
	Customer Client Drawn By Dessiné Par Material Matière 14 Ga Cold Rolled A1008 CS Type B (1.7mm)	Date Date 2022-10-19
Description 1412BTCU 225A - 4Wires x 108" Assembly		Detail Rev. Rev. 3 0
Part Number Numéro Pièce <b>1412BTCU09204DT</b>		Rev. 0 17

This drawing is confidential and must not be reproduced or used without the consent of EXM

Ce dessin est confidentiel et ne doit pas être reproduit ou utilisé sans le consentement de EXM



TOP



BACK

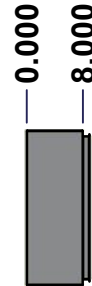

LEFT



FRONT

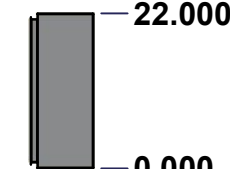

RIGHT



BOTTOM

No.	Revisions	Date	By/Par

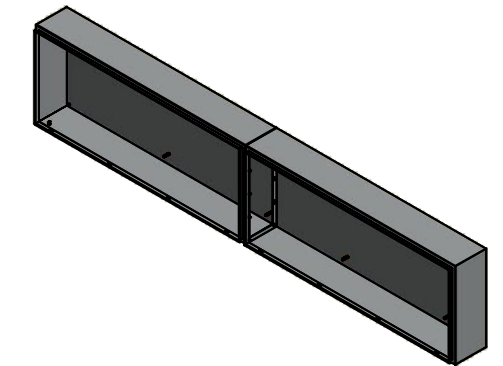

Isometric View



Tél: (450) 979-4373  
 Fax: (450) 979-4626  
[www.exmweb.com](http://www.exmweb.com)

Flatness  
Aplatissement

Max 3.0mm

Projection

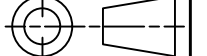

Customer Client	Date
Drawn By Dessiné Par BoxCad: BoxCad	Date 2022-10-19
Material Matière 14 Ga Cold Rolled A1008 CS Type B (1.7mm)	
Color Couleur Asa-61 Grey	Finish Fini Smooth
Description 1412BTCU 22" x 108" x 8" Body	Detail Rev.
Part Number Numéro Pièce <b>1412BTCU09204DTB</b>	Rev. <b>0</b>

SEE BILL OF MATERIAL ON LAST PAGE

This drawing is confidential and must not be reproduced or used without the consent of Eurobox

Ce dessin est confidentiel et ne doit pas être reproduit ou utilisé sans le consentement de Eurobox

**STANDARD FEATURES ARE NOT LISTED IN THIS HOLE TABLE**

**HOLE TABLE - BACK VIEW (CUSTOM FEATURE ONLY)**

CUT-OUT	XDIM	YDIM	DESCRIPTION
1	104.000	20.000	GND STUD M8 x 35mm (Inside)
2	104.000	18.000	GND STUD M8 x 35mm (Inside)
3	9.375	20.563	IP STUD M8 x 35mm (Inside)
4	35.625	20.563	IP STUD M8 x 35mm (Inside)
5	9.375	2.475	IP STUD M8 x 35mm (Inside)
6	35.625	2.475	IP STUD M8 x 35mm (Inside)
7	55.375	20.563	IP STUD M8 x 35mm (Inside)
8	81.625	20.563	IP STUD M8 x 35mm (Inside)
9	55.375	2.475	IP STUD M8 x 35mm (Inside)
10	81.625	2.475	IP STUD M8 x 35mm (Inside)

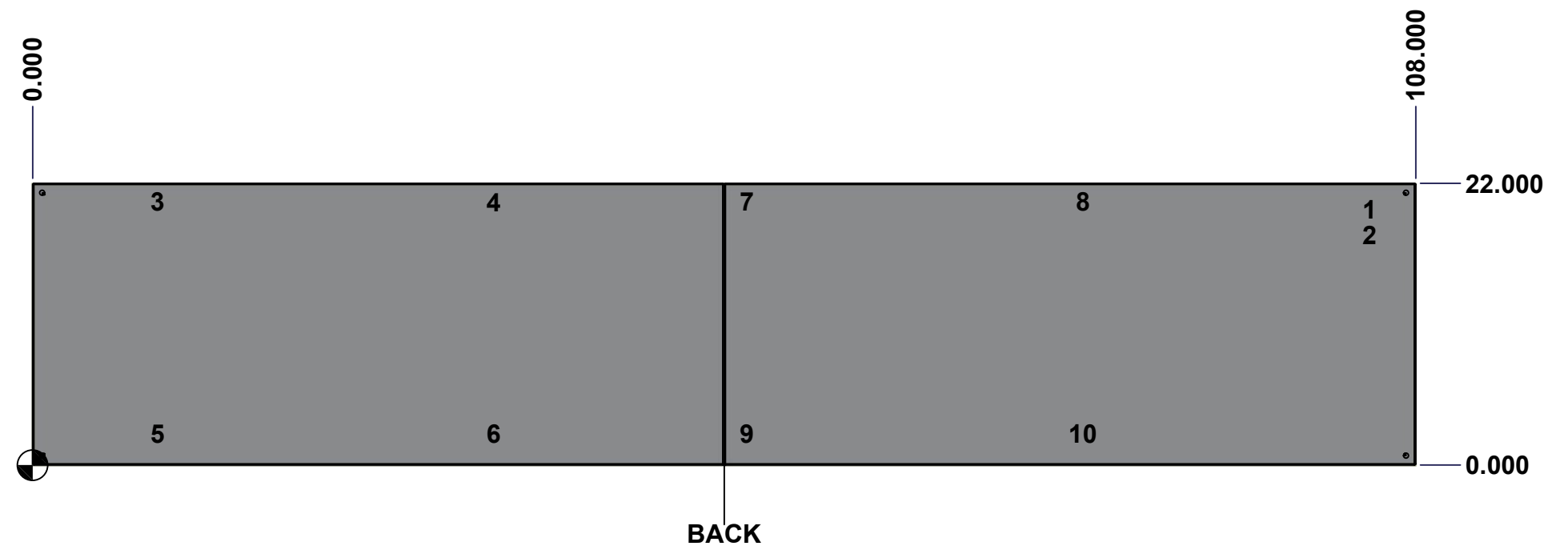

	Description		Status
	1412BTCU 22" x 108" x 8" Body		(NULL)
Part Number Numéro Pièce		Rev.	5
<b>1412BTCU09204DTB</b>		<b>0</b>	17

This drawing is confidential and must not be reproduced or used without the consent of EXM

Ce dessin est confidentiel et ne doit pas être reproduit ou utilisé sans le consentement de EXM

No.	Revisions	Date	By/Par

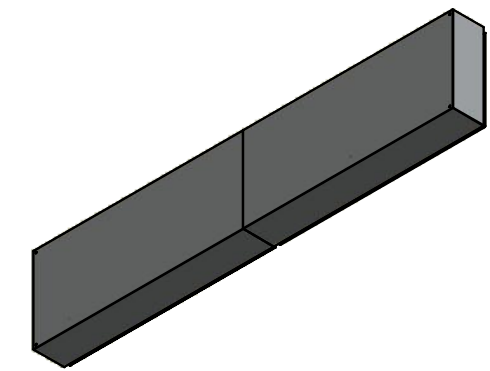

Isometric View

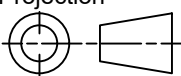

 Tél: (450) 979-4373 Fax: (450) 979-4626 <a href="http://www.exmweb.com">www.exmweb.com</a>		Flatness Aplatissement Max 3.0mm Projection 
Customer Client	Date	
Drawn By Dessiné Par	BoxCad: BoxCad	Date 2022-10-19
Material Matière	14 Ga Cold Rolled A1008 CS Type B (1.7mm)	
Color Couleur	Asa-61 Grey	Finish Fini Smooth
Description		Detail Rev.
1412BTCU 22" x 108" x 8" Body		
Part Number Numéro Pièce	Rev. 0	6 / 17
<b>1412BTCU09204DTB</b>		

Qty	Part Number	Rev	Description
1	STK-P-02400S	0	Powder Paint (Asa-61 Grey / Smooth)
1	1412BTCU09204DTB-P	0	1412BTCU 22" x 108" x 8" Left Body Part
1	1412BTCU09204DTE-P	0	1412BTCU 22" x 108" x 8" Right Body Part
1	STK-G-00701	0	1" x 1/4" Self-Adhesive Neoprene Gasket
10	STK-Q-00260	1	M6 x 13mm Carriage Bolt
10	STK-Q-07220	1	M6 Nylon Insert Lock Nut
10	STK-Q-16005	1	Stud M8 x 35 (No Paint Cap Required)
2	STK-Q-16080	0	Ground Stud M6 x 16mm
1	STK-S-00100	0	3.5" x 2" Silver Milar Flexcon Sticker
Parts List			

This drawing is confidential and must not be reproduced or used without the consent of Eurobex

Ce dessin est confidentiel et ne doit pas être reproduit ou utilisé sans le consentement de Eurobex

STANDARD FEATURES ARE NOT LISTED IN THIS HOLE TABLE			
HOLE TABLE - FRONT VIEW (CUSTOM FEATURE ONLY)			
CUT-OUT	XDIM	YDIM	DESCRIPTION
1	79.500	0.500	RND Ø0.201 THREAD 1/4-20 UNC
2	73.500	0.500	RND Ø0.201 THREAD 1/4-20 UNC
3	67.500	0.500	RND Ø0.201 THREAD 1/4-20 UNC
4	61.500	0.500	RND Ø0.201 THREAD 1/4-20 UNC
5	55.500	0.500	RND Ø0.201 THREAD 1/4-20 UNC
6	49.500	0.500	RND Ø0.201 THREAD 1/4-20 UNC
7	43.500	0.500	RND Ø0.201 THREAD 1/4-20 UNC
8	37.500	0.500	RND Ø0.201 THREAD 1/4-20 UNC
9	31.500	0.500	RND Ø0.201 THREAD 1/4-20 UNC
10	25.500	0.500	RND Ø0.201 THREAD 1/4-20 UNC
11	19.500	0.500	RND Ø0.201 THREAD 1/4-20 UNC
12	13.500	0.500	RND Ø0.201 THREAD 1/4-20 UNC
13	7.500	0.500	RND Ø0.201 THREAD 1/4-20 UNC
14	1.500	0.500	RND Ø0.201 THREAD 1/4-20 UNC

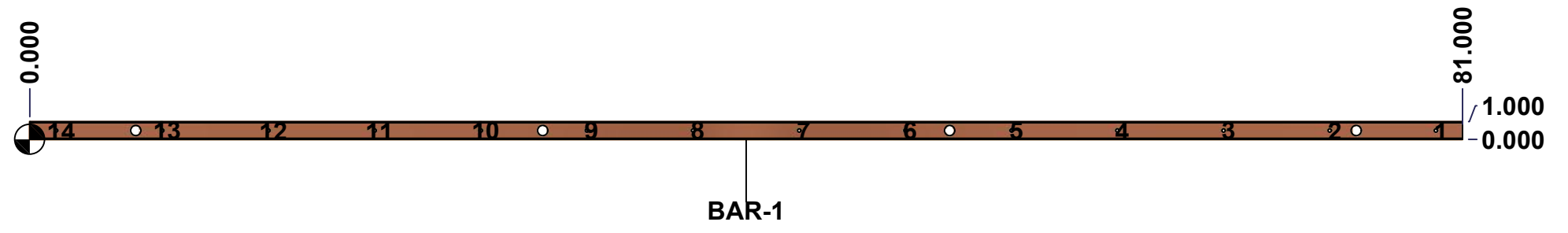

	Description		Status	
	Rounded Edge Copper Bar 1/8" x 1"		(NULL)	
Part Number Numéro Pièce		Rev.	7	
1412BTCU09204DTBAR1-P		0	17	

This drawing is confidential and must not be reproduced or used without the consent of Eurobex

Ce dessin est confidentiel et ne doit pas être reproduit ou utilisé sans le consentement de Eurobex

STANDARD FEATURES ARE NOT LISTED IN THIS HOLE TABLE			
HOLE TABLE - FRONT VIEW (CUSTOM FEATURE ONLY)			
CUT-OUT	XDIM	YDIM	DESCRIPTION
1	79.500	0.500	RND Ø0.201 THREAD 1/4-20 UNC
2	73.500	0.500	RND Ø0.201 THREAD 1/4-20 UNC
3	67.500	0.500	RND Ø0.201 THREAD 1/4-20 UNC
4	61.500	0.500	RND Ø0.201 THREAD 1/4-20 UNC
5	55.500	0.500	RND Ø0.201 THREAD 1/4-20 UNC
6	49.500	0.500	RND Ø0.201 THREAD 1/4-20 UNC
7	43.500	0.500	RND Ø0.201 THREAD 1/4-20 UNC
8	37.500	0.500	RND Ø0.201 THREAD 1/4-20 UNC
9	31.500	0.500	RND Ø0.201 THREAD 1/4-20 UNC
10	25.500	0.500	RND Ø0.201 THREAD 1/4-20 UNC
11	19.500	0.500	RND Ø0.201 THREAD 1/4-20 UNC
12	13.500	0.500	RND Ø0.201 THREAD 1/4-20 UNC
13	7.500	0.500	RND Ø0.201 THREAD 1/4-20 UNC
14	1.500	0.500	RND Ø0.201 THREAD 1/4-20 UNC

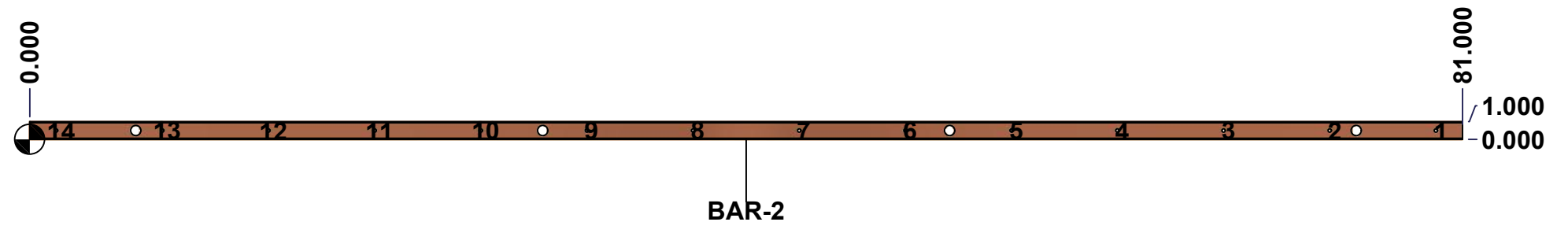

	Description Rounded Edge Copper Bar 1/8" x 1"	Status (NULL)
	Part Number Numéro Pièce <b>1412BTCU09204DTBAR2-P</b>	Rev. <b>0</b>



This drawing is confidential and must not be reproduced or used without the consent of Eurobex

Ce dessin est confidentiel et ne doit pas être reproduit ou utilisé sans le consentement de Eurobex

STANDARD FEATURES ARE NOT LISTED IN THIS HOLE TABLE			
HOLE TABLE - FRONT VIEW (CUSTOM FEATURE ONLY)			
CUT-OUT	XDIM	YDIM	DESCRIPTION
1	79.500	0.500	RND Ø0.201 THREAD 1/4-20 UNC
2	73.500	0.500	RND Ø0.201 THREAD 1/4-20 UNC
3	67.500	0.500	RND Ø0.201 THREAD 1/4-20 UNC
4	61.500	0.500	RND Ø0.201 THREAD 1/4-20 UNC
5	55.500	0.500	RND Ø0.201 THREAD 1/4-20 UNC
6	49.500	0.500	RND Ø0.201 THREAD 1/4-20 UNC
7	43.500	0.500	RND Ø0.201 THREAD 1/4-20 UNC
8	37.500	0.500	RND Ø0.201 THREAD 1/4-20 UNC
9	31.500	0.500	RND Ø0.201 THREAD 1/4-20 UNC
10	25.500	0.500	RND Ø0.201 THREAD 1/4-20 UNC
11	19.500	0.500	RND Ø0.201 THREAD 1/4-20 UNC
12	13.500	0.500	RND Ø0.201 THREAD 1/4-20 UNC
13	7.500	0.500	RND Ø0.201 THREAD 1/4-20 UNC
14	1.500	0.500	RND Ø0.201 THREAD 1/4-20 UNC

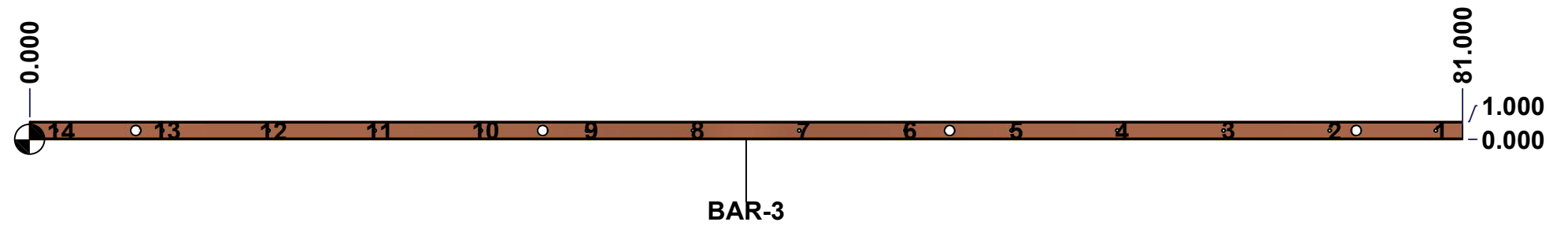

	Description	Status
	Rounded Edge Copper Bar 1/8" x 1"	(NULL)
	Part Number Numéro Pièce	Rev.
	<b>1412BTCU09204DTBAR3-P</b>	<b>0</b>
		9
		17

This drawing is confidential and must not be reproduced or used without the consent of Eurobex

Ce dessin est confidentiel et ne doit pas être reproduit ou utilisé sans le consentement de Eurobex

STANDARD FEATURES ARE NOT LISTED IN THIS HOLE TABLE			
HOLE TABLE - FRONT VIEW (CUSTOM FEATURE ONLY)			
CUT-OUT	XDIM	YDIM	DESCRIPTION
1	79.500	0.500	RND Ø0.201 THREAD 1/4-20 UNC
2	73.500	0.500	RND Ø0.201 THREAD 1/4-20 UNC
3	67.500	0.500	RND Ø0.201 THREAD 1/4-20 UNC
4	61.500	0.500	RND Ø0.201 THREAD 1/4-20 UNC
5	55.500	0.500	RND Ø0.201 THREAD 1/4-20 UNC
6	49.500	0.500	RND Ø0.201 THREAD 1/4-20 UNC
7	43.500	0.500	RND Ø0.201 THREAD 1/4-20 UNC
8	37.500	0.500	RND Ø0.201 THREAD 1/4-20 UNC
9	31.500	0.500	RND Ø0.201 THREAD 1/4-20 UNC
10	25.500	0.500	RND Ø0.201 THREAD 1/4-20 UNC
11	19.500	0.500	RND Ø0.201 THREAD 1/4-20 UNC
12	13.500	0.500	RND Ø0.201 THREAD 1/4-20 UNC
13	7.500	0.500	RND Ø0.201 THREAD 1/4-20 UNC
14	1.500	0.500	RND Ø0.201 THREAD 1/4-20 UNC

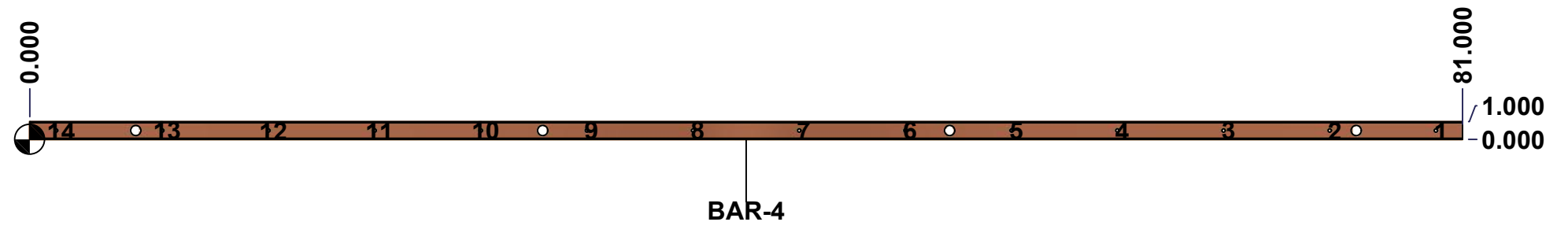

	Description Rounded Edge Copper Bar 1/8" x 1"	Status (NULL)
	Part Number Numéro Pièce <b>1412BTCU09204DTBAR4-P</b>	Rev. <b>0</b>

This drawing is confidential and must not be reproduced or used without the consent of EXM

Ce dessin est confidentiel et ne doit pas être reproduit ou utilisé sans le consentement de EXM

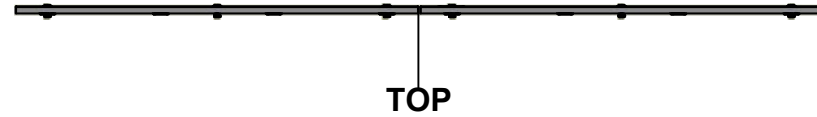

TOP

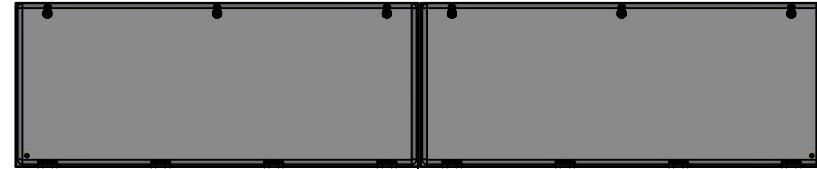

BACK



BOTTOM

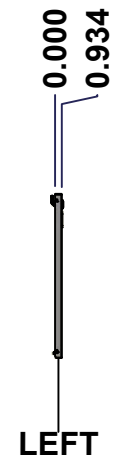

LEFT

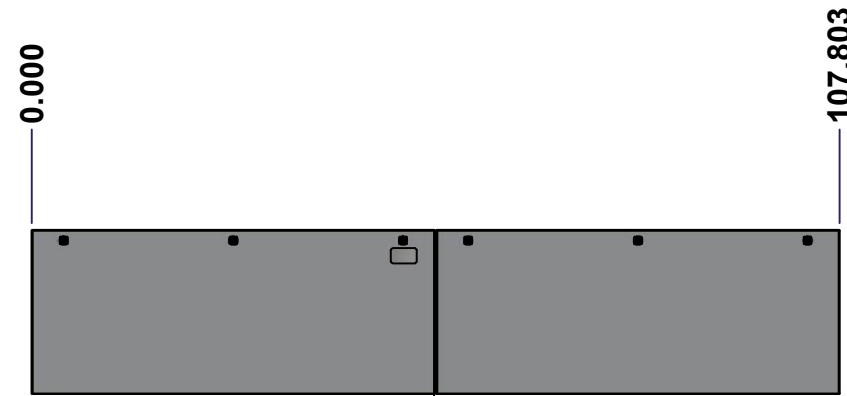

FRONT

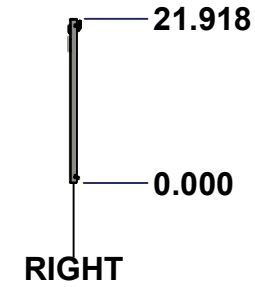

RIGHT

No.	Revisions	Date	By/Par

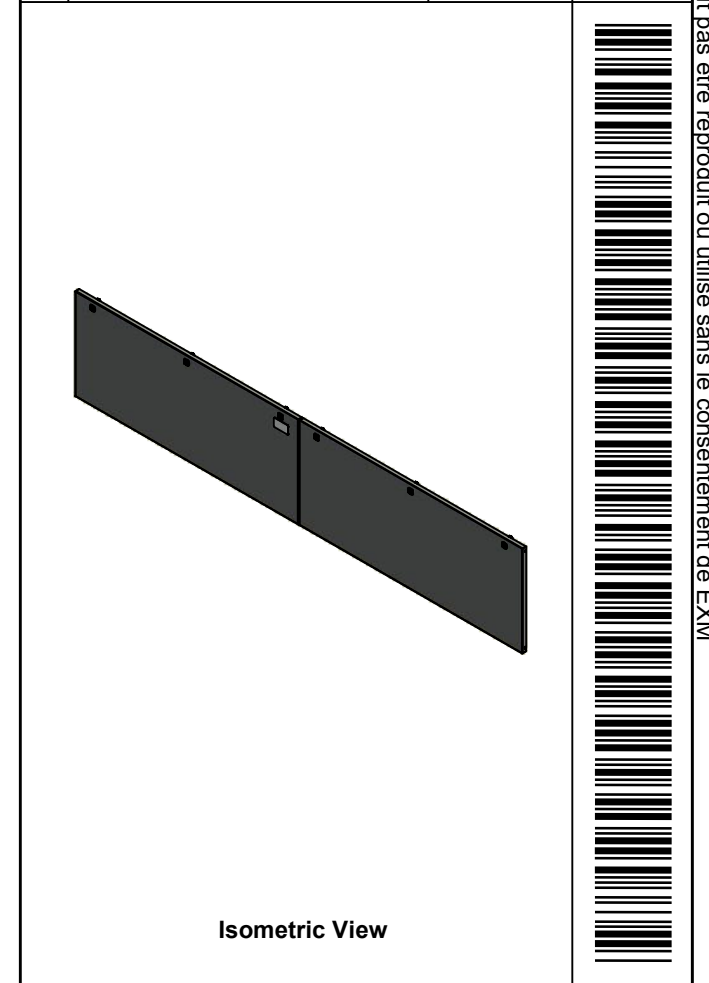

Isometric View

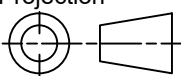

 Tél: (450) 979-4373 Fax: (450) 979-4626 <a href="http://www.exmweb.com">www.exmweb.com</a>		Flatness Aplatissement Max 3.0mm Projection 
Customer Client	Date	
Drawn By Dessiné Par	BoxCad: BoxCad	Date 2022-10-19
Material Matière	14 Ga Cold Rolled A1008 CS Type B (1.7mm)	
Color Couleur	Asa-61 Grey	Finish Fini Smooth
Description 1412BTCU 22" x 108" Cover		Detail Rev.
Part Number Numéro Pièce	Rev. 0	11 / 17

SEE BILL OF MATERIAL ON LAST PAGE

**1412BTCU09204DTC**

This drawing is confidential and must not be reproduced or used without the consent of Eurobox

Ce dessin est confidentiel et ne doit pas être reproduit ou utilisé sans le consentement de Eurobox

**STANDARD FEATURES ARE NOT LISTED IN THIS HOLE TABLE**

**HOLE TABLE - FRONT VIEW (CUSTOM FEATURE ONLY)**

CUT-OUT	XDIM	YDIM	DESCRIPTION
1	1.500	1.486	GND STUD M6 x 16mm (Inside)
2	106.303	1.486	GND STUD M6 x 16mm (Inside)
3	103.553	20.494	LOCK 880 SCQ4-SL @ 90.0°
4	80.902	20.494	LOCK 880 SCQ4-SL @ 90.0°
5	58.250	20.494	LOCK 880 SCQ4-SL @ 90.0°
6	49.553	20.494	LOCK 880 SCQ4-SL @ 90.0°
7	26.902	20.494	LOCK 880 SCQ4-SL @ 90.0°
8	4.250	20.494	LOCK 880 SCQ4-SL @ 90.0°

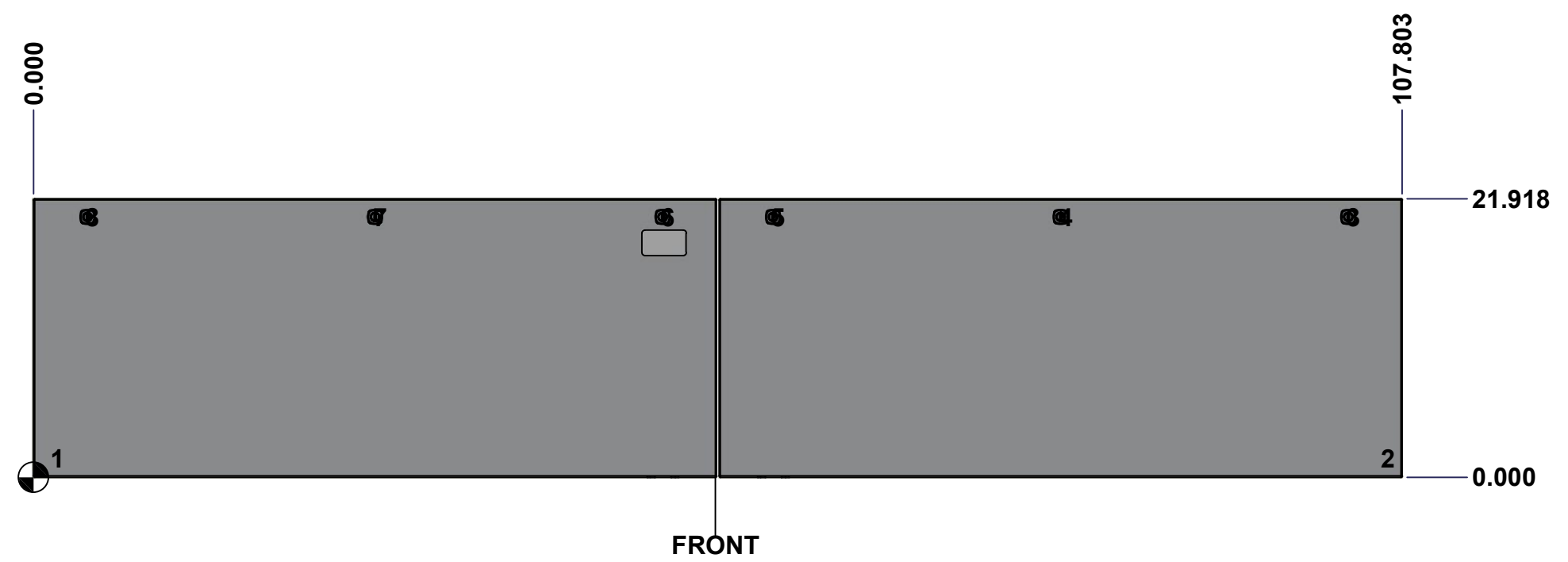



	Description	Status	
	1412BTCU 22" x 108" Cover	(NULL)	
	Part Number Numéro Pièce	Rev.	12
	<b>1412BTCU09204DTC</b>	<b>0</b>	17

This drawing is confidential and must not be reproduced or used without the consent of EXM

Ce dessin est confidentiel et ne doit pas être reproduit ou utilisé sans le consentement de EXM

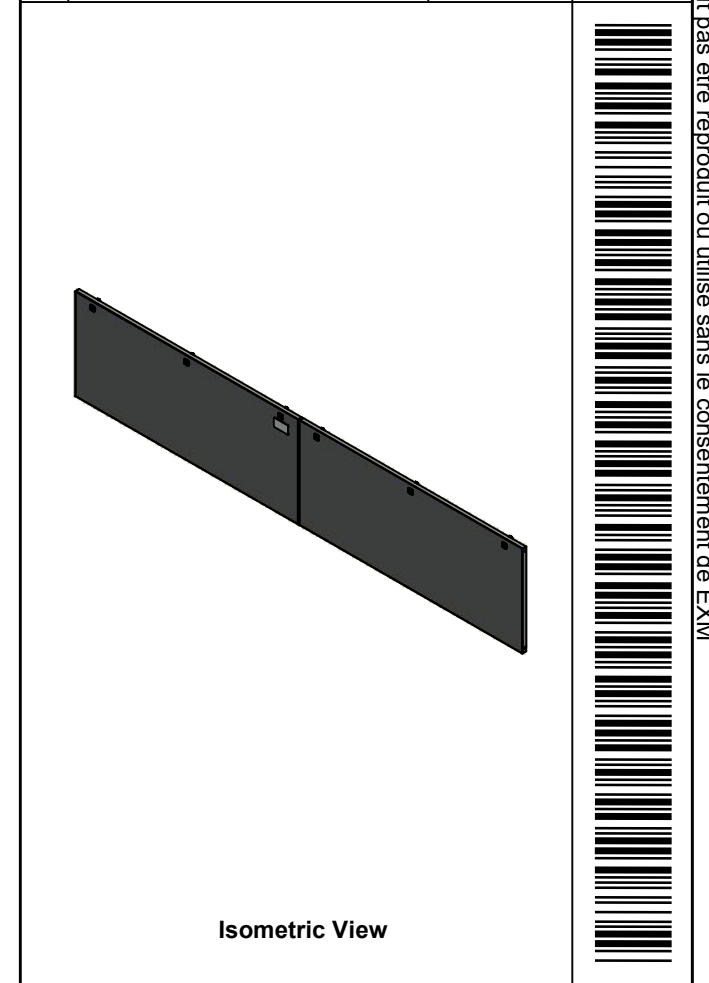
No.	Revisions	Date	By/Par

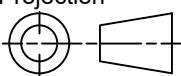

 Tél: (450) 979-4373 Fax: (450) 979-4626 <a href="http://www.exmweb.com">www.exmweb.com</a>		Flatness Aplatissement Max 3.0mm Projection 
Customer Client	Date	
Drawn By Dessiné Par	BoxCad: BoxCad	Date 2022-10-19
Material Matière	14 Ga Cold Rolled A1008 CS Type B (1.7mm)	
Color Couleur	Asa-61 Grey	Finish Fini Smooth
Description		Detail Rev.
1412BTCU 22" x 108" Cover		
Part Number Numéro Pièce	Rev.	13
<b>1412BTCU09204DTC</b>	<b>0</b>	17

Qty	Part Name	Rev	Description
2	1412BTCU09204DTG	0	1412BTCU 22" x 108" Cover Gasket
1	STK-P-02400S	0	Powder Paint (Asa-61 Grey / Smooth)
8	STK-K-09800	10	5412 ES Hinge with 2 Captive Hinge Pins
2	STK-Q-16080	0	Ground Stud M6 x 16mm
1	STK-S-00100	0	3.5" x 2" Silver Milar Flexcon Sticker
1	1412BTCU09204DTC-P	0	1412BTCU 22" x 54" Left Cover Part
1	1412BTCU09204DTF-P	0	1412BTCU 22" x 108" Right Cover Part
6	880 SCQ4-SL	6	5412 ES 1/4 Turn Lock
Parts List			

This drawing is confidential and must not be reproduced or used without the consent of EXM

Ce dessin est confidentiel et ne doit pas être reproduit ou utilisé sans le consentement de EXM

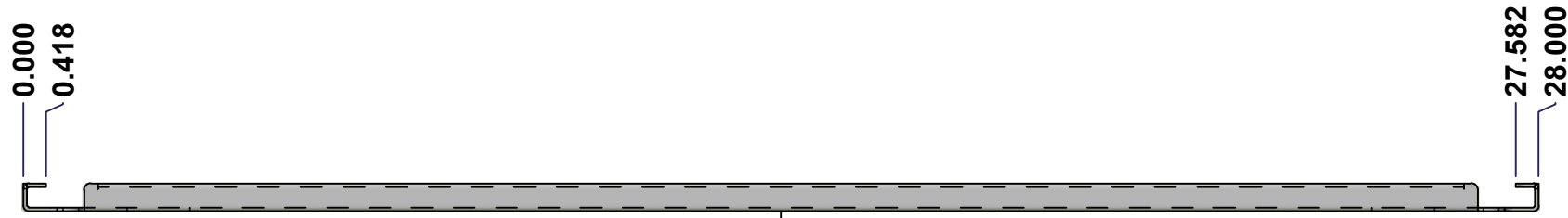

TOP



FRONT

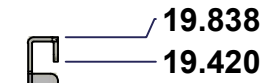

RIGHT



No.	Revisions	Date	By/Par

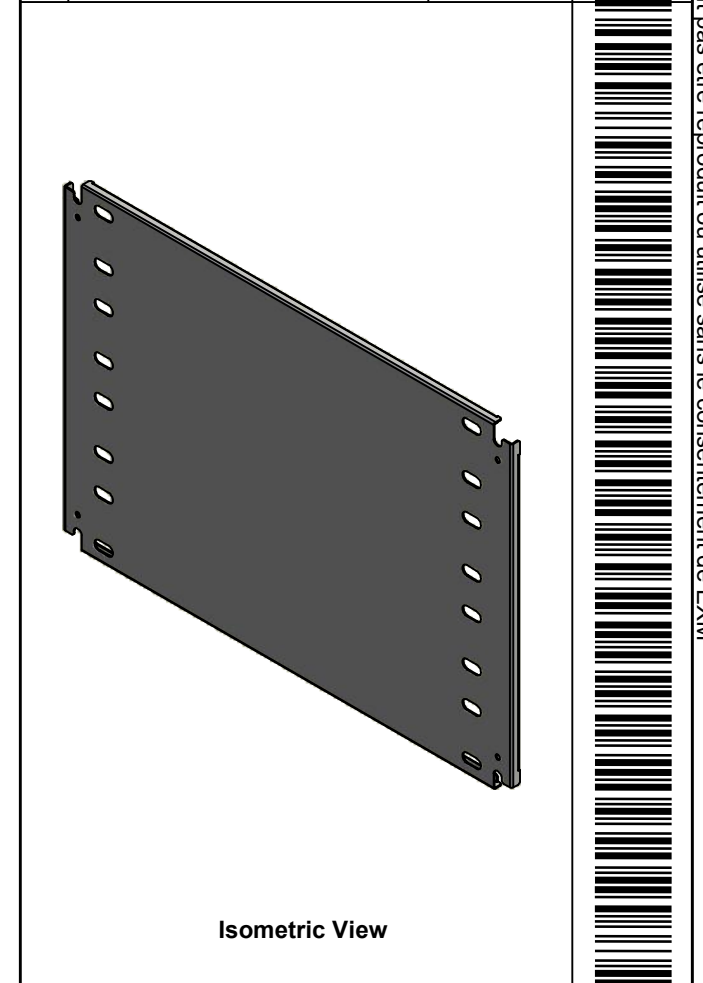

Isometric View

	Flatness Aplatissement Max 3.0mm
	Projection 
Customer Client	Date
Drawn By Dessiné Par BoxCad: BoxCad	Date 2022-10-19
Material Matière 14 Ga Cold Rolled A1008 CS Type B (1.7mm)	
Color Couleur White RAL9003	Finish Fini Smooth
Description 1412BTCU 19.838" x 28" Left Inner Panel	
Part Number Numéro Pièce <b>1412BTCU09204DTIP1</b>	Rev. 14 <b>0</b>

SEE BILL OF MATERIAL ON LAST PAGE

This drawing is confidential and must not be reproduced or used without the consent of EXM

Ce dessin est confidentiel et ne doit pas être reproduit ou utilisé sans le consentement de EXM

No.	Revisions	Date	By/Par

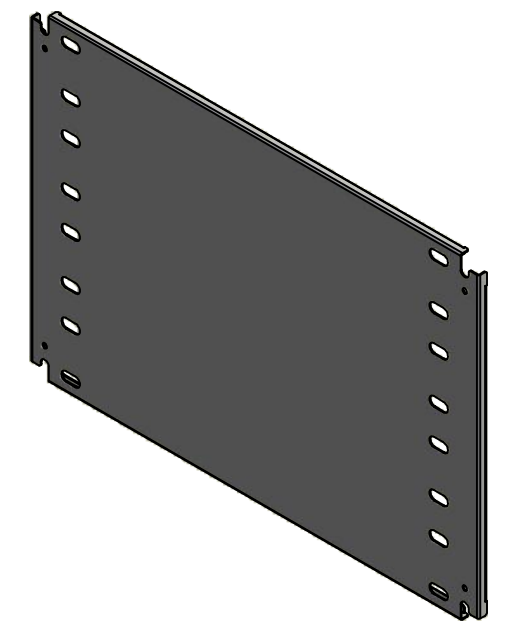

Isometric View

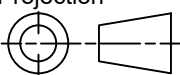

 Tél: (450) 979-4373 Fax: (450) 979-4626 <a href="http://www.exmweb.com">www.exmweb.com</a>	Flatness Aplatissement Max 3.0mm
	Projection 
Customer Client	Date
Drawn By / Dessiné Par: BoxCad: BoxCad	Date: 2022-10-19
Material / Matière: 14 Ga Cold Rolled A1008 CS Type B (1.7mm)	
Color / Couleur: White RAL9003	Finish / Fini: Smooth
Description: 1412BTCU 19.838" x 28" Left Inner Panel	Detail Rev.
Part Number / Numéro Pièce: <b>1412BTCU09204DTIP1</b>	Rev. 0

Qty	Part Number	Rev	Description
1	STK-P-02401S	0	Powder Paint (White / Smooth)
1	1412BTCU09204DTIP1-P	0	1412BTCU 19.838" x 108" Left Inner Panel Part
Parts List			

This drawing is confidential and must not be reproduced or used without the consent of EXM

Ce dessin est confidentiel et ne doit pas être reproduit ou utilisé sans le consentement de EXM

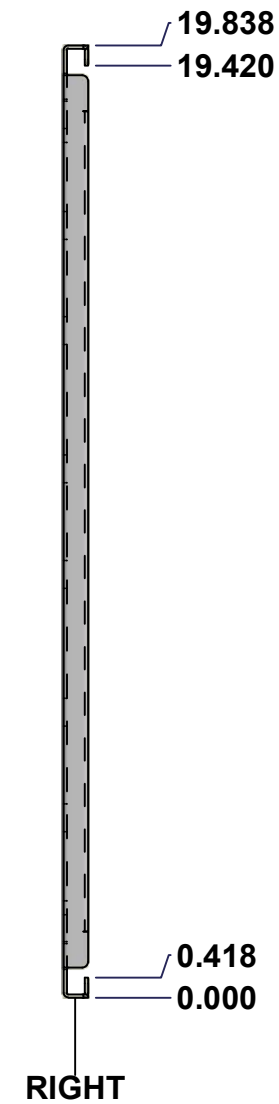
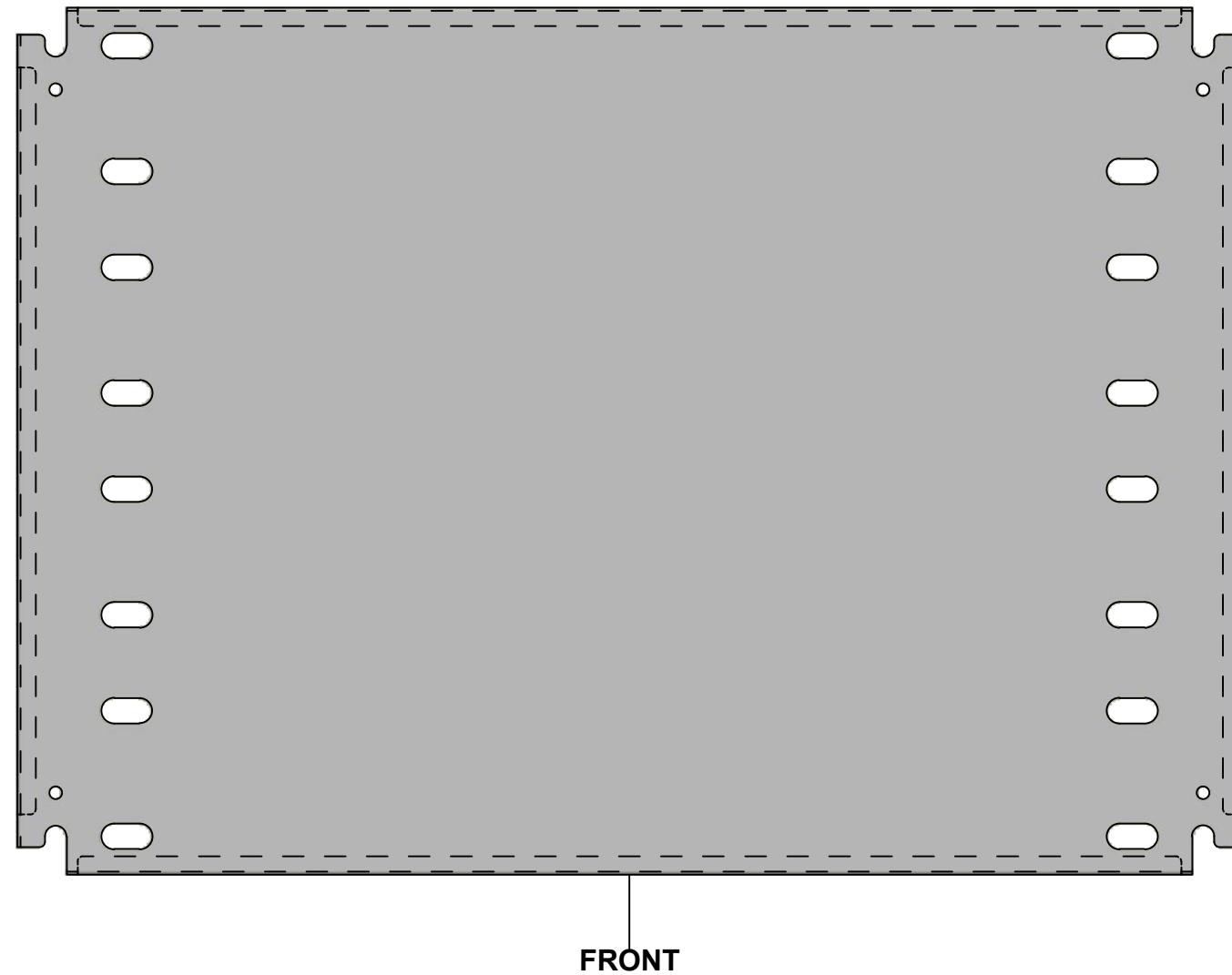
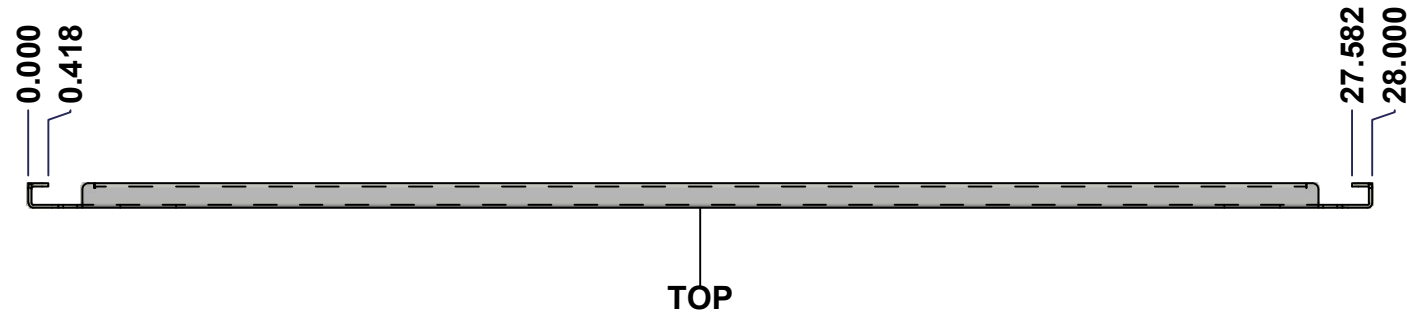

No.	Revisions	Date	By/Par

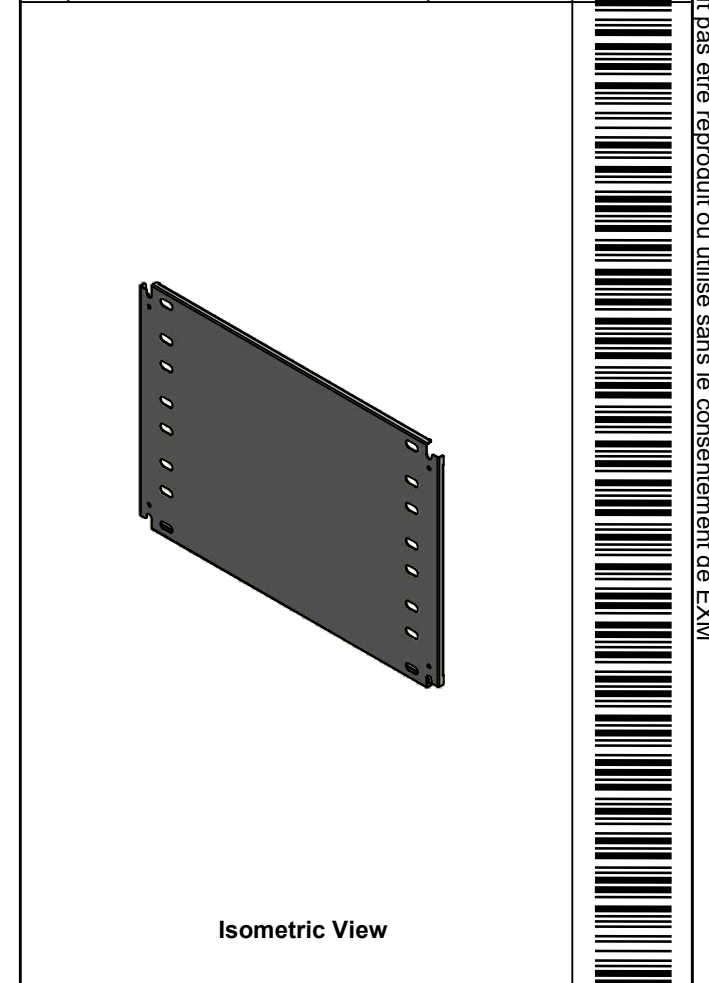

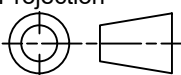
 Tél: (450) 979-4373 Fax: (450) 979-4626 <a href="http://www.exmweb.com">www.exmweb.com</a>		Flatness Aplatissement Max 3.0mm Projection 
Customer Client	Date	
Drawn By Dessiné Par	BoxCad: BoxCad	Date 2022-10-19
Material Matière	14 Ga Cold Rolled A1008 CS Type B (1.7mm)	
Color Couleur	White RAL9003	Finish Fini Smooth
Description 1412BTCU 19.838" x 28" Right Inner Panel		Detail Rev.
Part Number Numéro Pièce	Rev. 0	16 17

SEE BILL OF MATERIAL ON LAST PAGE

**1412BTCU09204DTIP2**



This drawing is confidential and must not be reproduced or used without the consent of EXM

Ce dessin est confidentiel et ne doit pas être reproduit ou utilisé sans le consentement de EXM

No.	Revisions	Date	By/Par

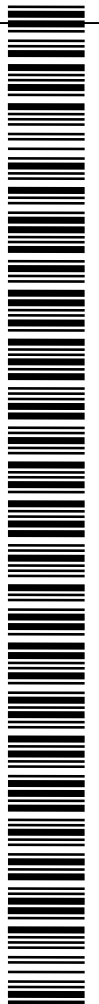
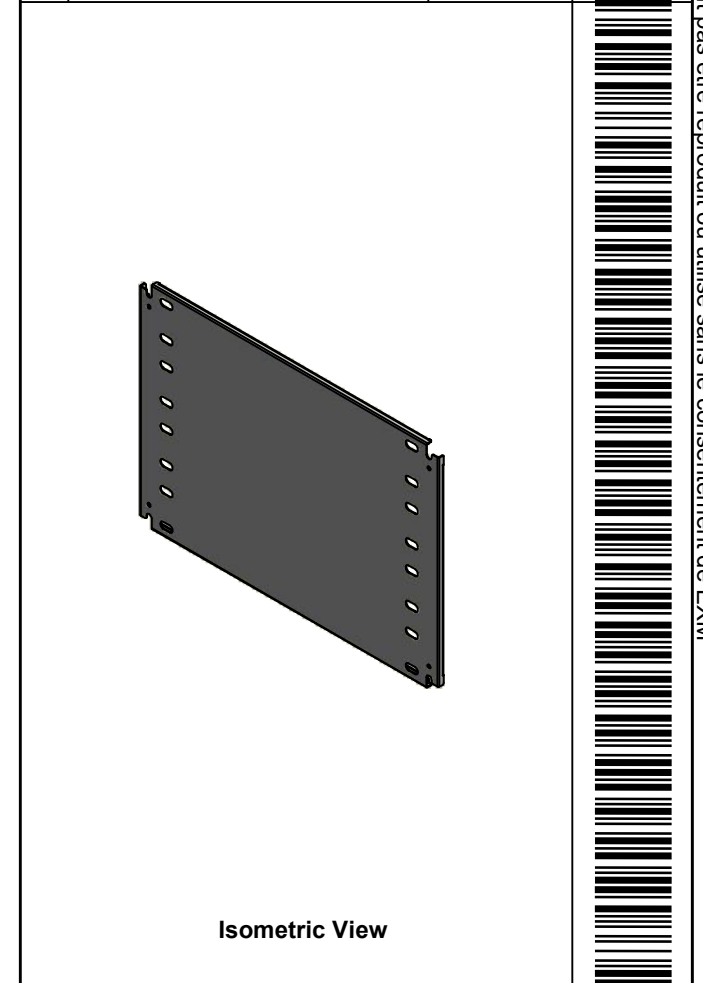

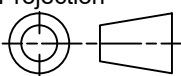
 Tél: (450) 979-4373 Fax: (450) 979-4626 <a href="http://www.exmweb.com">www.exmweb.com</a>		Flatness Aplatissement Max 3.0mm
Customer Client		Projection 
Drawn By / Dessiné Par: BoxCad: BoxCad		Date: 2022-10-19
Material / Matière: 14 Ga Cold Rolled A1008 CS Type B (1.7mm)		
Color / Couleur: White RAL9003	Finish / Fini: Smooth	
Description: 1412BTCU 19.838" x 28" Right Inner Panel		Detail Rev.
Part Number / Numéro Pièce: <b>1412BTCU09204DTIP2</b>		Rev. 17 <b>0</b>

Qty	Part Number	Rev	Description
1	STK-P-02401S	0	Powder Paint (White / Smooth)
1	1412BTCU09204DTIP2-P	0	1412BTCU 19.838" x 108" Right Inner Panel Part
Parts List			