

This drawing is confidential and must not be reproduced or used without the consent of EXM

Ce dessin est confidentiel et ne doit pas être reproduit ou utilisé sans le consentement de EXM



TOP



LEFT

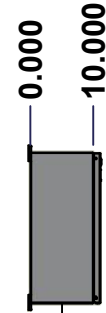

LEFT

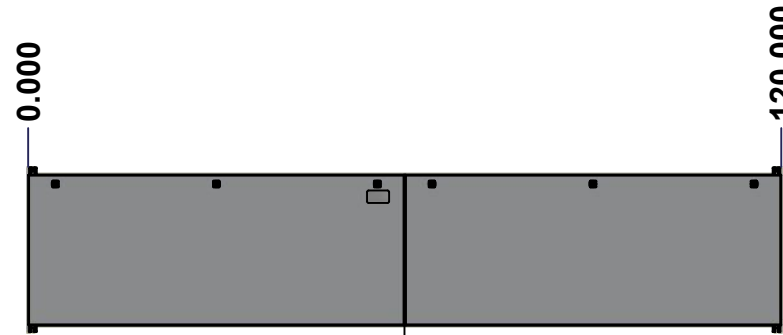

FRONT

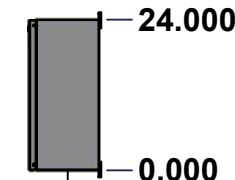

RIGHT



BOTTOM

No.	Revisions	Date	By/Par

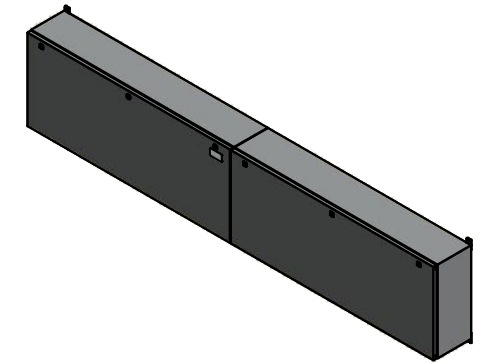

Isometric View



Tél: (450) 979-4373  
 Fax: (450) 979-4626  
[www.exmweb.com](http://www.exmweb.com)

Flatness  
Aplatissement

Max 3.0mm

Projection

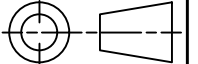

Customer Client	Date
Drawn By Dessiné Par BoxCad: BoxCad	Date 21-Oct-22
Material Matière 14 Ga Cold Rolled A1008 CS Type B (1.7mm)	
Color Couleur Asa-61 Grey	Finish Fini Smooth
Description 1412BTCU 1000A - 3Wires x 120" Assembly	Detail Rev.
Part Number Numéro Pièce <b>1412BTCU101003DT</b>	Rev. <b>0</b>

SEE BILL OF MATERIAL ON LAST PAGE

This drawing is confidential and must not be reproduced or used without the consent of Eurobox

Ce dessin est confidentiel et ne doit pas être reproduit ou utilisé sans le consentement de Eurobox

**STANDARD FEATURES ARE NOT LISTED IN THIS HOLE TABLE**

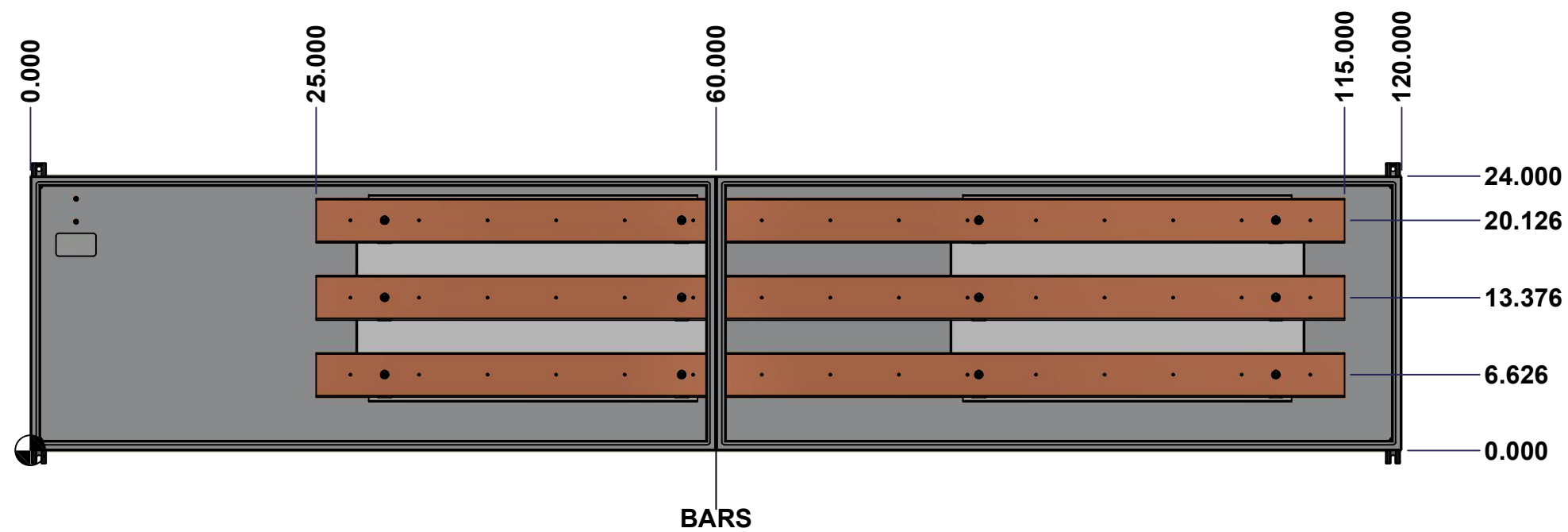

	Description 1412BTCU 1000A - 3Wires x 120" Assembly		Status (NULL)
	Part Number Numéro Pièce <b>1412BTCU101003DT</b>		Rev. 2 <b>0</b>

This drawing is confidential and must not be reproduced or used without the consent of EXM

Ce dessin est confidentiel et ne doit pas être reproduit ou utilisé sans le consentement de EXM

NOTE	
ITEM	DESCRIPTION
1	NEMA 4/12 Enclosure
2	C/W Standard ground studs on box and cover
3	W/O Standard door stiffener
4	C/W Special inner panel (Sold separately)
5	C/W Standard inner panel mounting studs

No.	Revisions	Date	By/Par

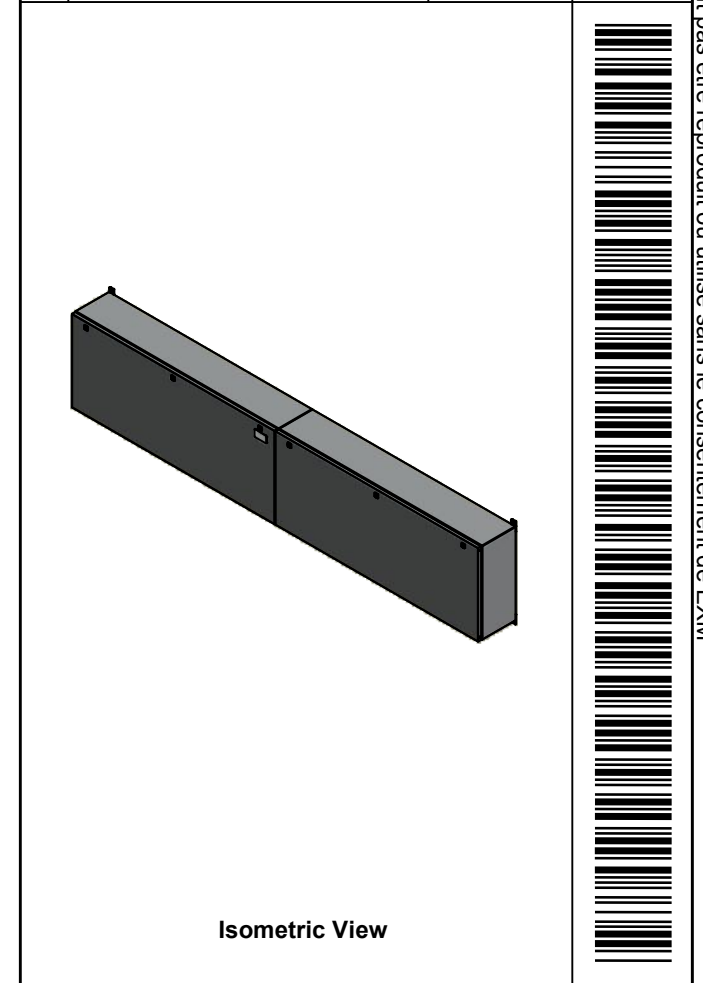

PACKING		
ITEM	QTY	DESCRIPTION
Cardboard sleeve	2	Top and Bottom
Cardboard strip	2	Between back of enclosure and inner panel
Plastic bag	1	To protect cover surface and inside gasket
Cardboard corner	4	To reinforced for the plastic strap tightening
Plastic strap - Black	2	To Squeeze 2 cardboard sleeve together
Packaging label	3	White label with PN
Plastic strap- Green	2	To secure the enclosure to the wood pallet
Wood Pallet	1	2" deeper and 3" larger than enclosure size

1	885 ESMF1	0	885 ESMF1 Mounting Feet Kit
1	1412BTCU101003DTIP2	0	1412BTCU 18.125" x 31" Right Inner Panel
1	1412BTCU101003DTBAR 1-P	0	Rounded Edge Copper Bar 1/4" x 4"
1	1412BTCU101003DTBAR 2-P	0	Rounded Edge Copper Bar 1/4" x 4"
1	1412BTCU101003DTBAR 3-P	0	Rounded Edge Copper Bar 1/4" x 4"
1	1412BTCU101003DTIP1	0	1412BTCU 18.125" x 31" Left Inner Panel
12	STK-A-67400	0	Buss Bar Insulator Kit
1	STK-K-01800	5	5412 ES Accessory Kit
8	STK-Q-04050-07	7	M6 x 7mm Hexagon Socket Head Machine Screw with Nyseal
20	STK-Q-07310	2	Flange Lock Nut M8
8	STK-Q-07610	8	M8 Plastic Spacer 22.2mm
1	1412BTCU101003DTB	0	1412BTCU 24" x 120" x 10" Body
1	1412BTCU101003DTC	0	1412BTCU 24" x 120" Cover
Qty	Part Number	Rev	Description
Parts List			



Tél: (450) 979-4373  
Fax: (450) 979-4626  
[www.exmweb.com](http://www.exmweb.com)

Flatness  
Aplatissement  
Max 3.0mm

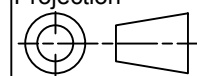
Projection  

Customer Client	Date
Drawn By Dessiné Par BoxCad: BoxCad	Date 21-Oct-22
Material Matière 14 Ga Cold Rolled A1008 CS Type B (1.7mm)	
Color Couleur Asa-61 Grey	Finish Fini Smooth
Description 1412BTCU 1000A - 3Wires x 120" Assembly	Detail Rev.
Part Number Numéro Pièce <b>1412BTCU101003DT</b>	Rev. <b>0</b>

3
16

This drawing is confidential and must not be reproduced or used without the consent of EXM

Ce dessin est confidentiel et ne doit pas être reproduit ou utilisé sans le consentement de EXM



TOP



BACK

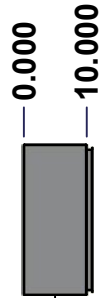

LEFT



FRONT

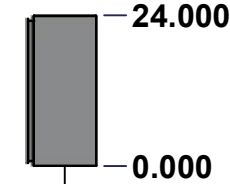

RIGHT



BOTTOM

No.	Revisions	Date	By/Par

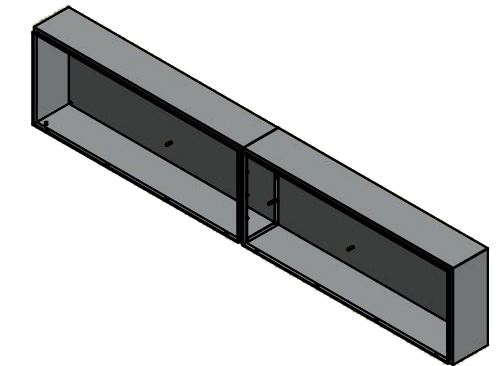

Isometric View



Tél: (450) 979-4373  
 Fax: (450) 979-4626  
[www.exmweb.com](http://www.exmweb.com)

Flatness  
Aplatissement

Max 3.0mm

Projection

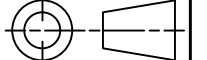

Customer Client	Date
Drawn By Dessiné Par BoxCad: BoxCad	Date 21-Oct-22
Material Matière 14 Ga Cold Rolled A1008 CS Type B (1.7mm)	

Color Couleur Asa-61 Grey	Finish Fini Smooth
------------------------------	-----------------------

Description 1412BTCU 24" x 120" x 10" Body	Detail Rev.
---	-------------

Part Number Numéro Pièce <b>1412BTCU101003DTB</b>	Rev. <b>0</b>	4
--	---------------	---

SEE BILL OF MATERIAL ON LAST PAGE

This drawing is confidential and must not be reproduced or used without the consent of Eurobox

Ce dessin est confidentiel et ne doit pas être reproduit ou utilisé sans le consentement de Eurobox

**STANDARD FEATURES ARE NOT LISTED IN THIS HOLE TABLE**

**HOLE TABLE - BACK VIEW (CUSTOM FEATURE ONLY)**

CUT-OUT	XDIM	YDIM	DESCRIPTION
1	116.000	22.000	GND STUD M8 x 35mm (Inside)
2	116.000	20.000	GND STUD M8 x 35mm (Inside)
3	9.375	21.500	IP STUD M8 x 35mm (Inside)
4	38.625	21.500	IP STUD M8 x 35mm (Inside)
5	9.375	5.125	IP STUD M8 x 35mm (Inside)
6	38.625	5.125	IP STUD M8 x 35mm (Inside)
7	61.375	21.500	IP STUD M8 x 35mm (Inside)
8	90.625	21.500	IP STUD M8 x 35mm (Inside)
9	61.375	5.125	IP STUD M8 x 35mm (Inside)
10	90.625	5.125	IP STUD M8 x 35mm (Inside)

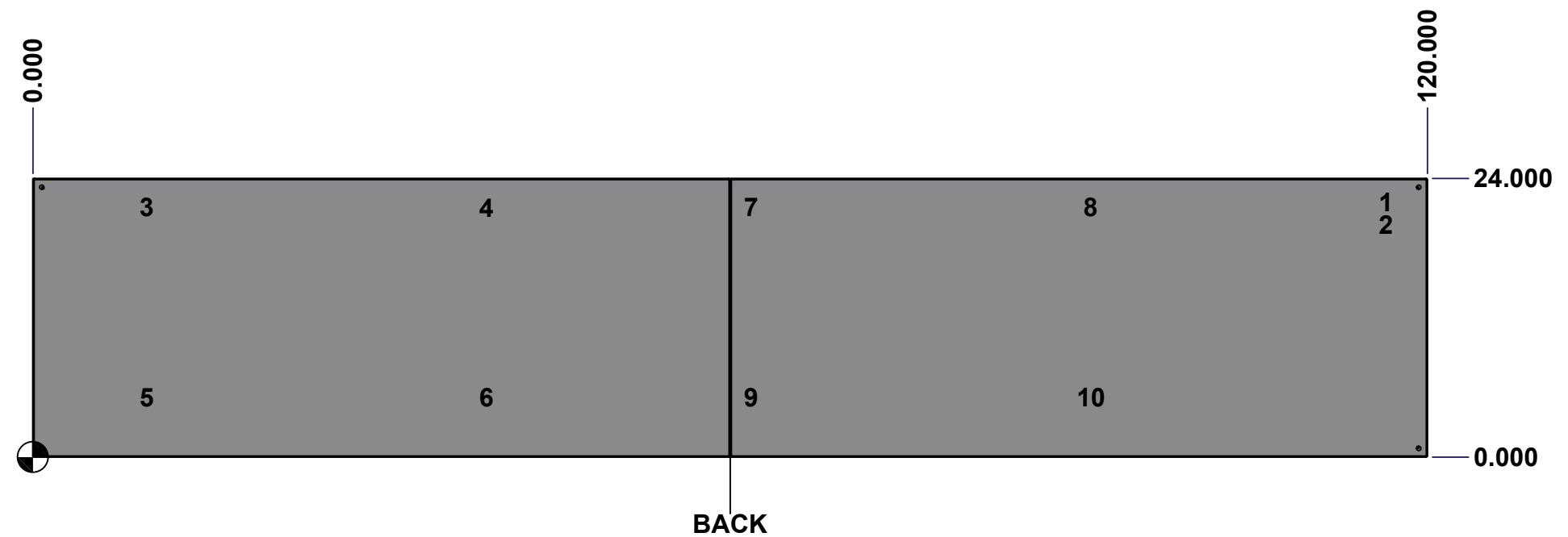

	Description	Status
	1412BTCU 24" x 120" x 10" Body	(NULL)
	Part Number Numéro Pièce	Rev.
	<b>1412BTCU101003DTB</b>	<b>0</b> / 5
		16

This drawing is confidential and must not be reproduced or used without the consent of EXM

Ce dessin est confidentiel et ne doit pas être reproduit ou utilisé sans le consentement de EXM

No.	Revisions	Date	By/Par

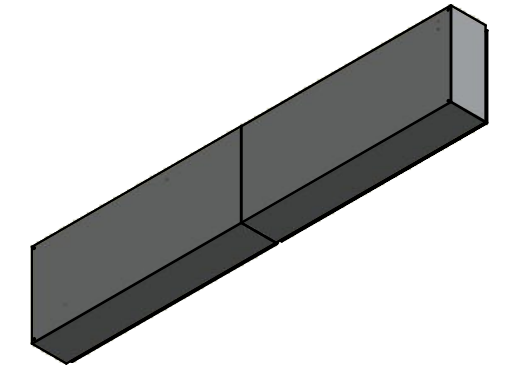

Isometric View

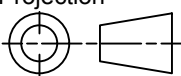

 Tél: (450) 979-4373 Fax: (450) 979-4626 <a href="http://www.exmweb.com">www.exmweb.com</a>		Flatness Aplatissement Max 3.0mm Projection 
Customer Client	Date	
Drawn By Dessiné Par	BoxCad: BoxCad	Date 21-Oct-22
Material Matière	14 Ga Cold Rolled A1008 CS Type B (1.7mm)	
Color Couleur	Asa-61 Grey	Finish Fini Smooth
Description		Detail Rev.
1412BTCU 24" x 120" x 10" Body		
Part Number Numéro Pièce	Rev. 0	6 / 16
<b>1412BTCU101003DTB</b>		

Qty	Part Number	Rev	Description
1	STK-P-02400S	0	Powder Paint (Asa-61 Grey / Smooth)
1	1412BTCU101003DTB-P	0	1412BTCU 24" x 120" x 10" Left Body Part
1	1412BTCU101003DTE-P	0	1412BTCU 24" x 120" x 10" Right Body Part
1	STK-G-00701	0	1" x 1/4" Self-Adhesive Neoprene Gasket
10	STK-Q-00260	1	M6 x 13mm Carriage Bolt
10	STK-Q-07220	1	M6 Nylon Insert Lock Nut
10	STK-Q-16005	1	Stud M8 x 35 (No Paint Cap Required)
2	STK-Q-16080	0	Ground Stud M6 x 16mm
1	STK-S-00100	0	3.5" x 2" Silver Milar Flexcon Sticker
Parts List			

This drawing is confidential and must not be reproduced or used without the consent of Eurobex

Ce dessin est confidentiel et ne doit pas être reproduit ou utilisé sans le consentement de Eurobex

STANDARD FEATURES ARE NOT LISTED IN THIS HOLE TABLE			
HOLE TABLE - FRONT VIEW (CUSTOM FEATURE ONLY)			
CUT-OUT	XDIM	YDIM	DESCRIPTION
1	87.000	2.000	RND Ø0.201 THREAD 1/4-20 UNC
2	81.000	2.000	RND Ø0.201 THREAD 1/4-20 UNC
3	75.000	2.000	RND Ø0.201 THREAD 1/4-20 UNC
4	69.000	2.000	RND Ø0.201 THREAD 1/4-20 UNC
5	63.000	2.000	RND Ø0.201 THREAD 1/4-20 UNC
6	57.000	2.000	RND Ø0.201 THREAD 1/4-20 UNC
7	51.000	2.000	RND Ø0.201 THREAD 1/4-20 UNC
8	45.000	2.000	RND Ø0.201 THREAD 1/4-20 UNC
9	39.000	2.000	RND Ø0.201 THREAD 1/4-20 UNC
10	33.000	2.000	RND Ø0.201 THREAD 1/4-20 UNC
11	27.000	2.000	RND Ø0.201 THREAD 1/4-20 UNC
12	21.000	2.000	RND Ø0.201 THREAD 1/4-20 UNC
13	15.000	2.000	RND Ø0.201 THREAD 1/4-20 UNC
14	9.000	2.000	RND Ø0.201 THREAD 1/4-20 UNC
15	3.000	2.000	RND Ø0.201 THREAD 1/4-20 UNC

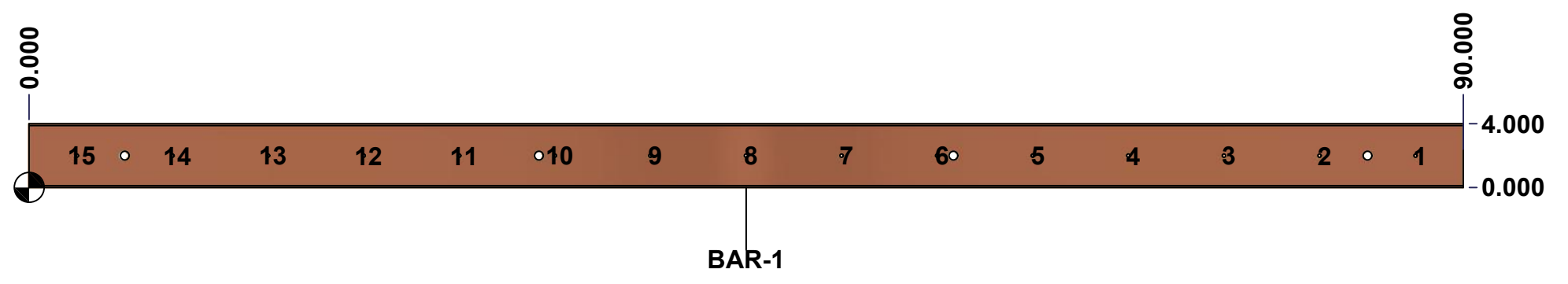

	Description	Status	
	Rounded Edge Copper Bar 1/4" x 4"	(NULL)	
	Part Number Numéro Pièce	Rev.	7
	<b>1412BTCU101003DTBAR1-P</b>	<b>0</b>	16

This drawing is confidential and must not be reproduced or used without the consent of Eurobex

Ce dessin est confidentiel et ne doit pas être reproduit ou utilisé sans le consentement de Eurobex

STANDARD FEATURES ARE NOT LISTED IN THIS HOLE TABLE			
HOLE TABLE - FRONT VIEW (CUSTOM FEATURE ONLY)			
CUT-OUT	XDIM	YDIM	DESCRIPTION
1	87.000	2.000	RND Ø0.201 THREAD 1/4-20 UNC
2	81.000	2.000	RND Ø0.201 THREAD 1/4-20 UNC
3	75.000	2.000	RND Ø0.201 THREAD 1/4-20 UNC
4	69.000	2.000	RND Ø0.201 THREAD 1/4-20 UNC
5	63.000	2.000	RND Ø0.201 THREAD 1/4-20 UNC
6	57.000	2.000	RND Ø0.201 THREAD 1/4-20 UNC
7	51.000	2.000	RND Ø0.201 THREAD 1/4-20 UNC
8	45.000	2.000	RND Ø0.201 THREAD 1/4-20 UNC
9	39.000	2.000	RND Ø0.201 THREAD 1/4-20 UNC
10	33.000	2.000	RND Ø0.201 THREAD 1/4-20 UNC
11	27.000	2.000	RND Ø0.201 THREAD 1/4-20 UNC
12	21.000	2.000	RND Ø0.201 THREAD 1/4-20 UNC
13	15.000	2.000	RND Ø0.201 THREAD 1/4-20 UNC
14	9.000	2.000	RND Ø0.201 THREAD 1/4-20 UNC
15	3.000	2.000	RND Ø0.201 THREAD 1/4-20 UNC

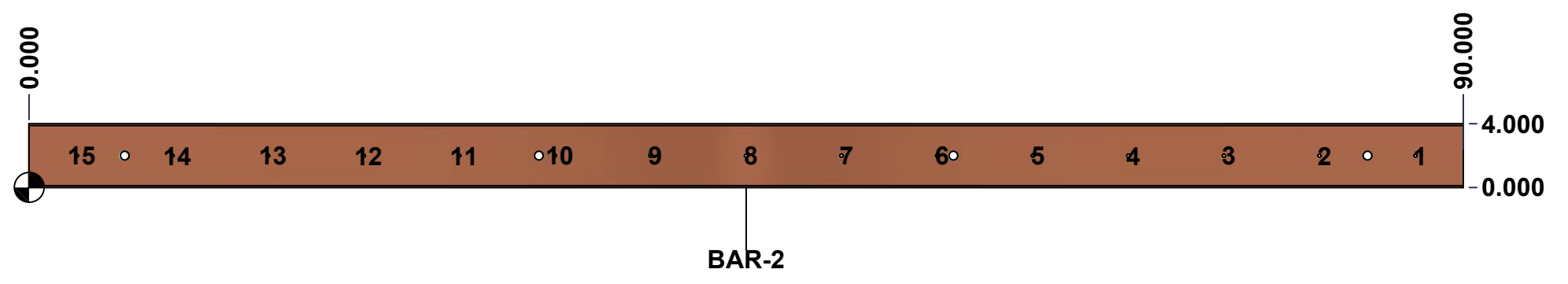

	Description	Status
	Rounded Edge Copper Bar 1/4" x 4"	(NULL)
	Part Number Numéro Pièce	Rev.
	<b>1412BTCU101003DTBAR2-P</b>	8
		<b>0</b>
		16



This drawing is confidential and must not be reproduced or used without the consent of Eurobex

Ce dessin est confidentiel et ne doit pas être reproduit ou utilisé sans le consentement de Eurobex

STANDARD FEATURES ARE NOT LISTED IN THIS HOLE TABLE			
HOLE TABLE - FRONT VIEW (CUSTOM FEATURE ONLY)			
CUT-OUT	XDIM	YDIM	DESCRIPTION
1	87.000	2.000	RND Ø0.201 THREAD 1/4-20 UNC
2	81.000	2.000	RND Ø0.201 THREAD 1/4-20 UNC
3	75.000	2.000	RND Ø0.201 THREAD 1/4-20 UNC
4	69.000	2.000	RND Ø0.201 THREAD 1/4-20 UNC
5	63.000	2.000	RND Ø0.201 THREAD 1/4-20 UNC
6	57.000	2.000	RND Ø0.201 THREAD 1/4-20 UNC
7	51.000	2.000	RND Ø0.201 THREAD 1/4-20 UNC
8	45.000	2.000	RND Ø0.201 THREAD 1/4-20 UNC
9	39.000	2.000	RND Ø0.201 THREAD 1/4-20 UNC
10	33.000	2.000	RND Ø0.201 THREAD 1/4-20 UNC
11	27.000	2.000	RND Ø0.201 THREAD 1/4-20 UNC
12	21.000	2.000	RND Ø0.201 THREAD 1/4-20 UNC
13	15.000	2.000	RND Ø0.201 THREAD 1/4-20 UNC
14	9.000	2.000	RND Ø0.201 THREAD 1/4-20 UNC
15	3.000	2.000	RND Ø0.201 THREAD 1/4-20 UNC

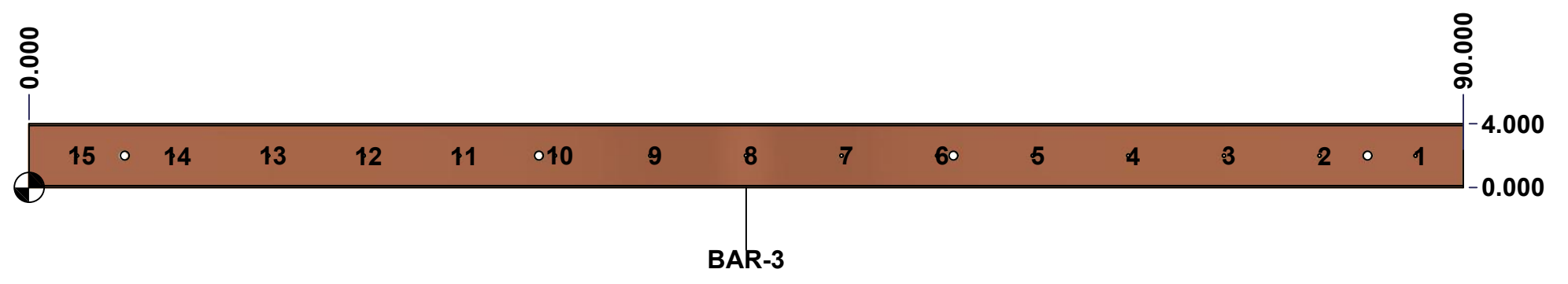

	Description	Status
	Rounded Edge Copper Bar 1/4" x 4"	(NULL)
	Part Number Numéro Pièce	Rev.
	<b>1412BTCU101003DTBAR3-P</b>	9
		<b>0</b>
		16

This drawing is confidential and must not be reproduced or used without the consent of EXM

Ce dessin est confidentiel et ne doit pas être reproduit ou utilisé sans le consentement de EXM

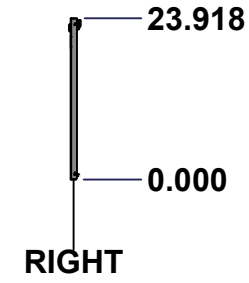
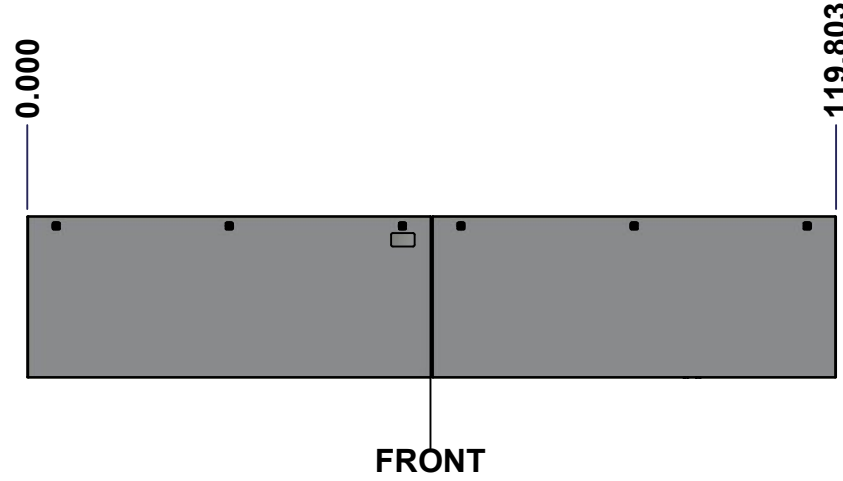
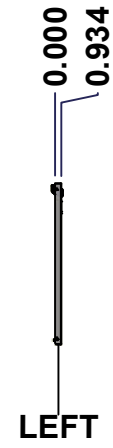
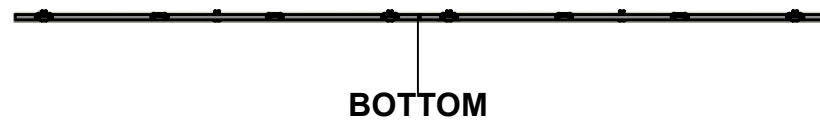
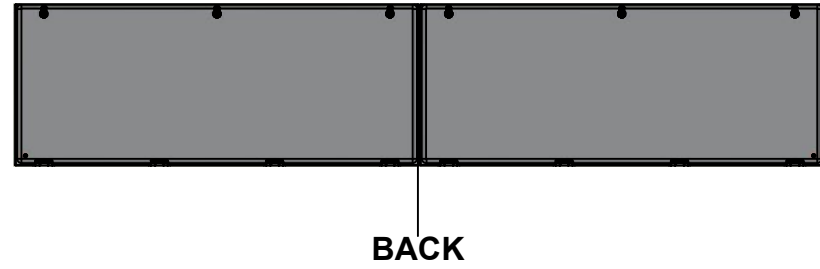
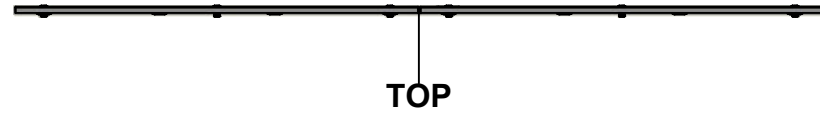

No.	Revisions	Date	By/Par

**Isometric View**

Tél: (450) 979-4373 Fax: (450) 979-4626 <a href="http://www.exmweb.com">www.exmweb.com</a>		Flatness Aplatissement	
		Max 3.0mm	
Customer Client		Date	
Drawn By Dessiné Par BoxCad: BoxCad		Date 21-Oct-22	
Material Matière 14 Ga Cold Rolled A1008 CS Type B (1.7mm)			
Color Couleur Asa-61 Grey		Finish Fini Smooth	
Description 1412BTCU 24" x 120" Cover			Detail Rev.
Part Number Numéro Pièce <b>1412BTCU101003DTC</b>		Rev. <b>0</b>	10 / 16

**SEE BILL OF MATERIAL ON LAST PAGE**

This drawing is confidential and must not be reproduced or used without the consent of Eurobox

Ce dessin est confidentiel et ne doit pas être reproduit ou utilisé sans le consentement de Eurobox

STANDARD FEATURES ARE NOT LISTED IN THIS HOLE TABLE			
HOLE TABLE - FRONT VIEW (CUSTOM FEATURE ONLY)			
CUT-OUT	XDIM	YDIM	DESCRIPTION
1	1.500	1.486	GND STUD M6 x 16mm (Inside)
2	118.303	1.486	GND STUD M6 x 16mm (Inside)
3	115.553	22.494	LOCK 880 SCQ4-SL @ 90.0°
4	89.902	22.494	LOCK 880 SCQ4-SL @ 90.0°
5	64.250	22.494	LOCK 880 SCQ4-SL @ 90.0°
6	55.553	22.494	LOCK 880 SCQ4-SL @ 90.0°
7	29.902	22.494	LOCK 880 SCQ4-SL @ 90.0°
8	4.250	22.494	LOCK 880 SCQ4-SL @ 90.0°

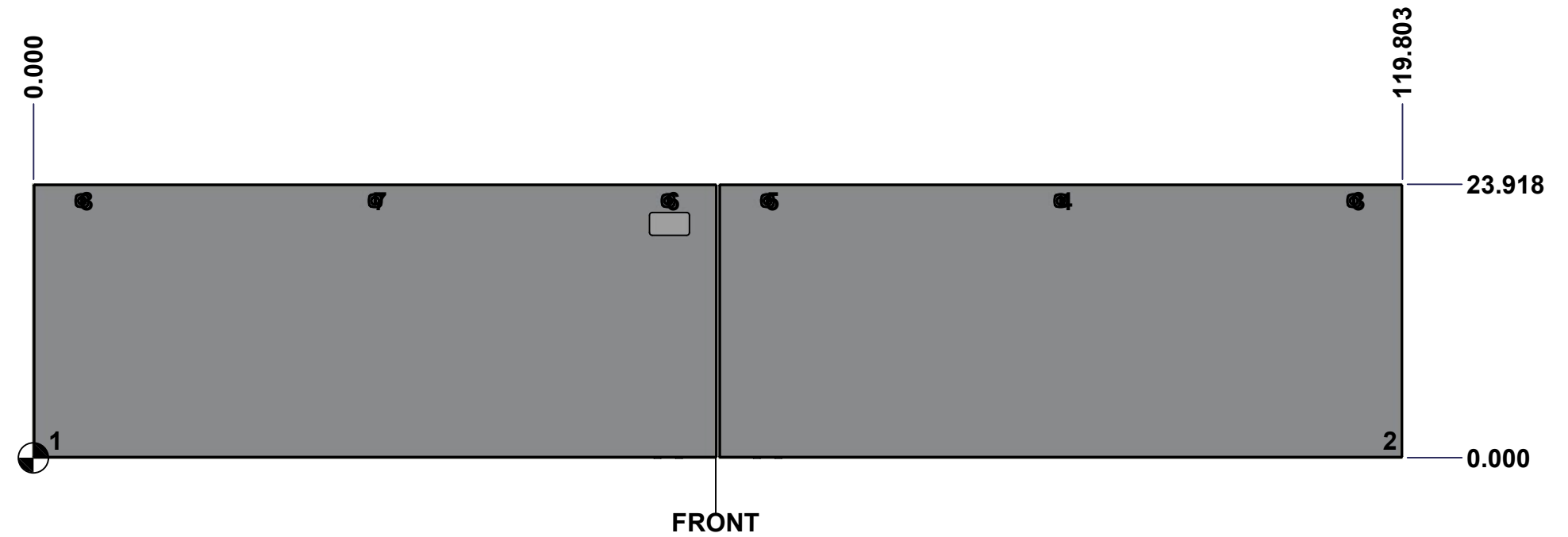

	Description	Status	
	1412BTCU 24" x 120" Cover	(NULL)	
	Part Number Numéro Pièce	Rev.	11
	<b>1412BTCU101003DTC</b>	<b>0</b>	16

This drawing is confidential and must not be reproduced or used without the consent of EXM

Ce dessin est confidentiel et ne doit pas être reproduit ou utilisé sans le consentement de EXM

No.	Revisions	Date	By/Par

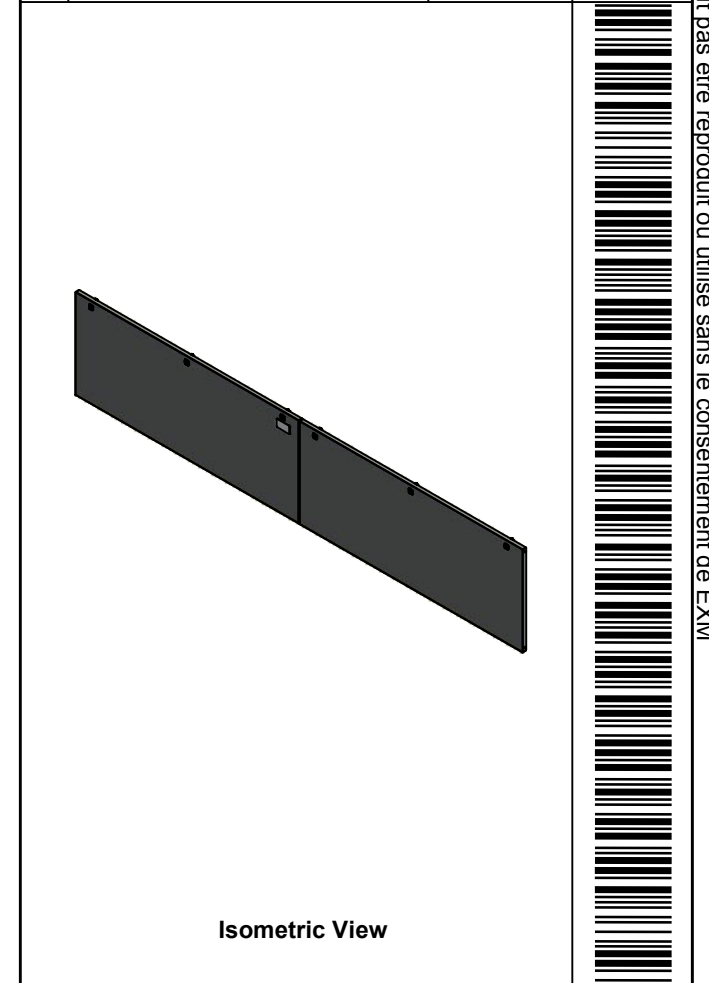

Isometric View

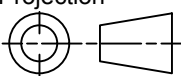
 Tél: (450) 979-4373 Fax: (450) 979-4626 <a href="http://www.exmweb.com">www.exmweb.com</a>		Flatness Aplatissement Max 3.0mm Projection 
Customer Client	Date	
Drawn By Dessiné Par	BoxCad: BoxCad	Date 21-Oct-22
Material Matière	14 Ga Cold Rolled A1008 CS Type B (1.7mm)	
Color Couleur	Asa-61 Grey	Finish Fini Smooth
Description		Detail Rev.
1412BTCU 24" x 120" Cover		
Part Number Numéro Pièce	Rev. 0	12 / 16
<b>1412BTCU101003DTC</b>		

2	1412BTCU101003DTG	0	1412BTCU 24" x 120" Cover Gasket
1	STK-P-02400S	0	Powder Paint (Asa-61 Grey / Smooth)
8	STK-K-09800	10	5412 ES Hinge with 2 Captive Hinge Pins
2	STK-Q-16080	0	Ground Stud M6 x 16mm
1	STK-S-00100	0	3.5" x 2" Silver Milar Flexcon Sticker
1	1412BTCU101003DTC-P	0	1412BTCU 24" x 60" Left Cover Part
1	1412BTCU101003DTF-P	0	1412BTCU 24" x 120" Right Cover Part
6	880 SCQ4-SL	6	5412 ES 1/4 Turn Lock
Qty	Part Name	Rev	Description
Parts List			

This drawing is confidential and must not be reproduced or used without the consent of EXM

Ce dessin est confidentiel et ne doit pas être reproduit ou utilisé sans le consentement de EXM

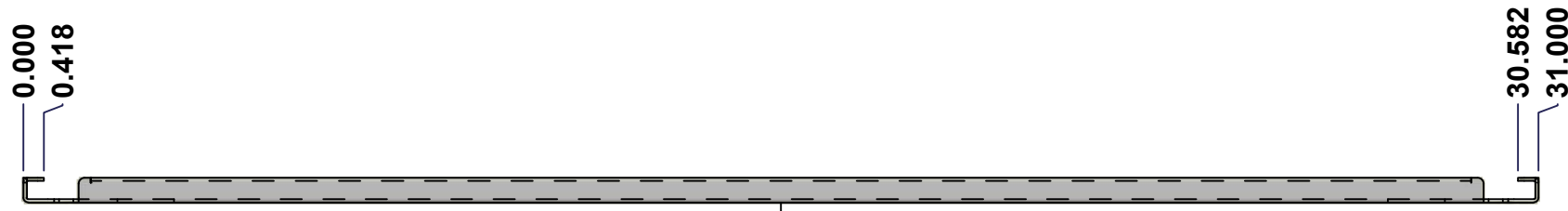

TOP



FRONT

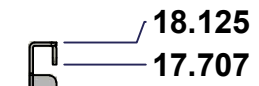

RIGHT



No.	Revisions	Date	By/Par

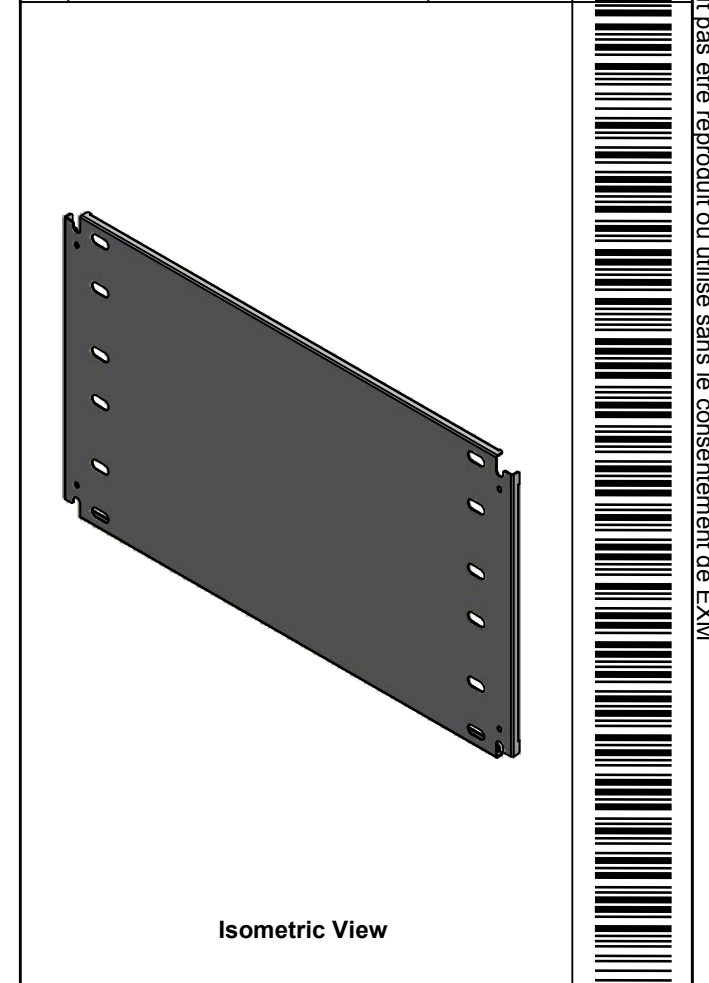

Tél: (450) 979-4373 Fax: (450) 979-4626 <a href="http://www.exmweb.com">www.exmweb.com</a>		Flatness Aplatissement Max 3.0mm Projection 
Customer Client	Date	
Drawn By Dessiné Par	BoxCad: BoxCad	Date 21-Oct-22
Material Matière	14 Ga Cold Rolled A1008 CS Type B (1.7mm)	
Color Couleur	White RAL9003	Finish Fini Smooth
Description 1412BTCU 18.125" x 31" Left Inner Panel		Detail Rev.
Part Number Numéro Pièce	Rev. 0	13 16

SEE BILL OF MATERIAL ON LAST PAGE

**1412BTCU101003DTIP1**

This drawing is confidential and must not be reproduced or used without the consent of EXM

Ce dessin est confidentiel et ne doit pas être reproduit ou utilisé sans le consentement de EXM

No.	Revisions	Date	By/Par

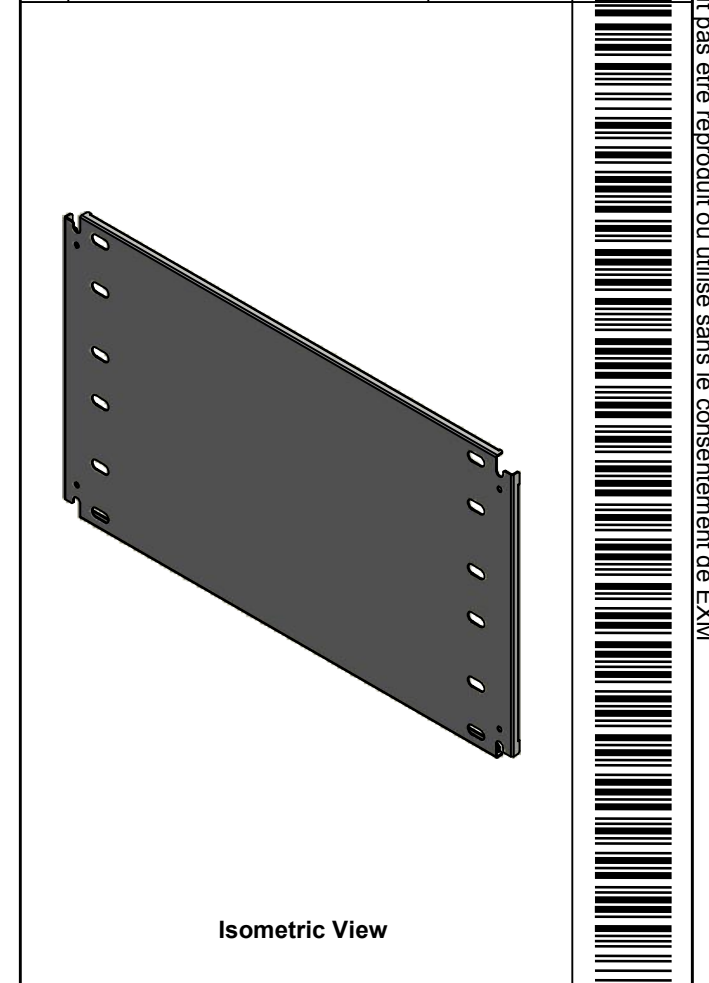

Isometric View

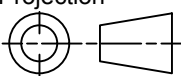

 Tél: (450) 979-4373 Fax: (450) 979-4626 <a href="http://www.exmweb.com">www.exmweb.com</a>		Flatness Aplatissement Max 3.0mm Projection 
Customer Client	Date	
Drawn By Dessiné Par	BoxCad: BoxCad	Date 21-Oct-22
Material Matière	14 Ga Cold Rolled A1008 CS Type B (1.7mm)	
Color Couleur	White RAL9003	Finish Fini Smooth
Description		Detail Rev.
1412BTCU 18.125" x 31" Left Inner Panel		
Part Number Numéro Pièce	Rev. 0	14 / 16
<b>1412BTCU101003DTIP1</b>		

Qty	Part Number	Rev	Description
1	STK-P-02401S	0	Powder Paint (White / Smooth)
1	1412BTCU101003DTIP1-P	0	1412BTCU 18.125" x 120" Left Inner Panel Part
Parts List			

This drawing is confidential and must not be reproduced or used without the consent of EXM

Ce dessin est confidentiel et ne doit pas être reproduit ou utilisé sans le consentement de EXM

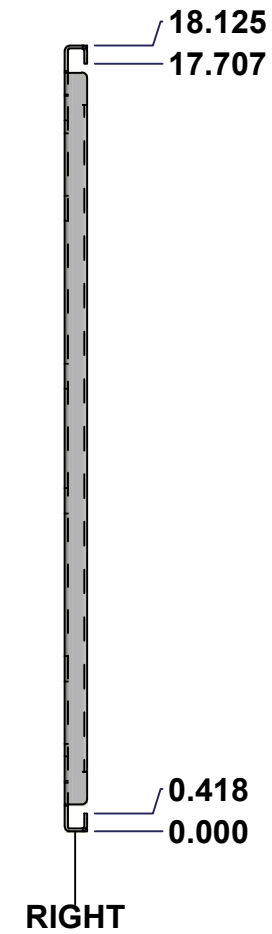
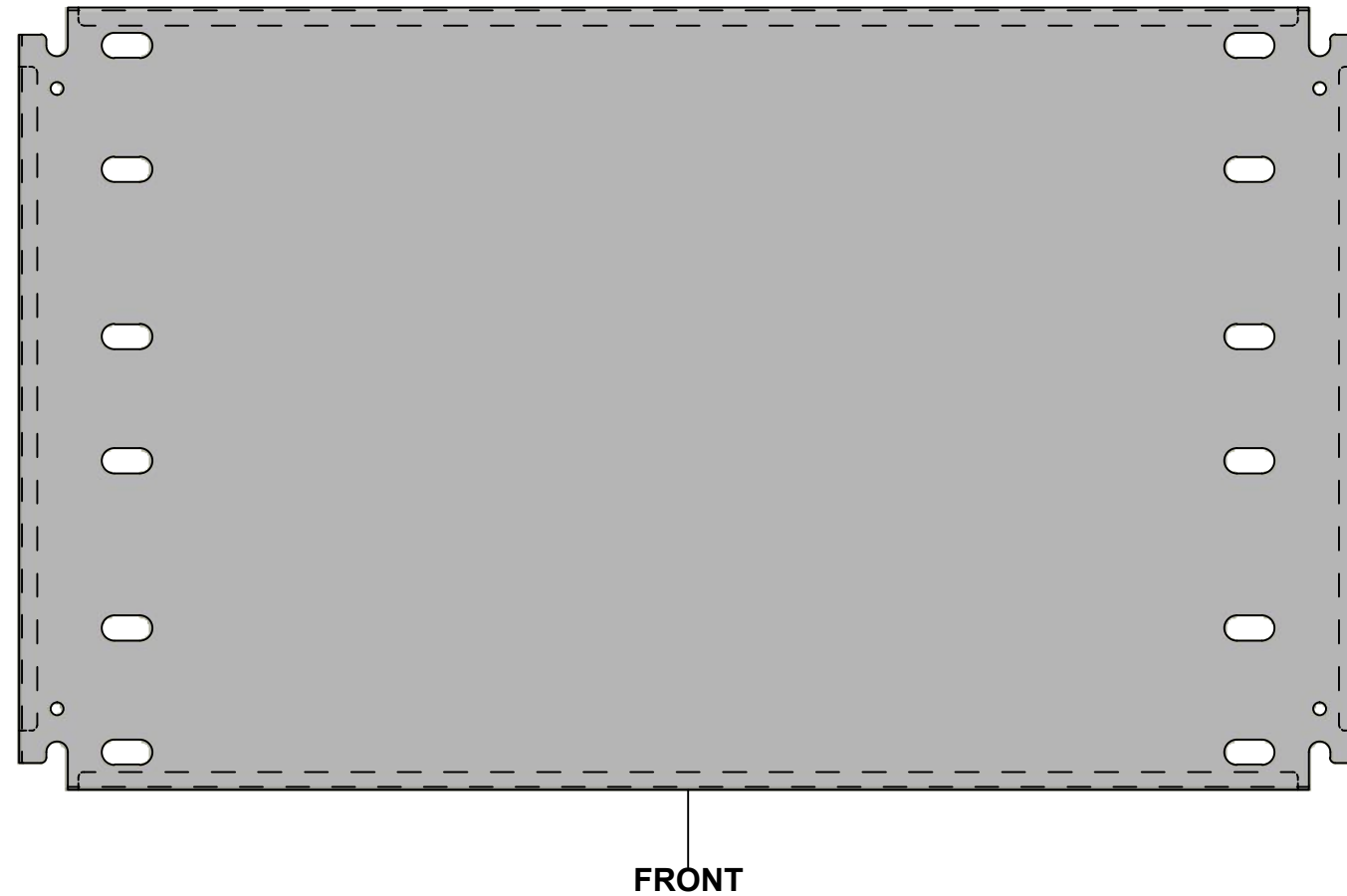
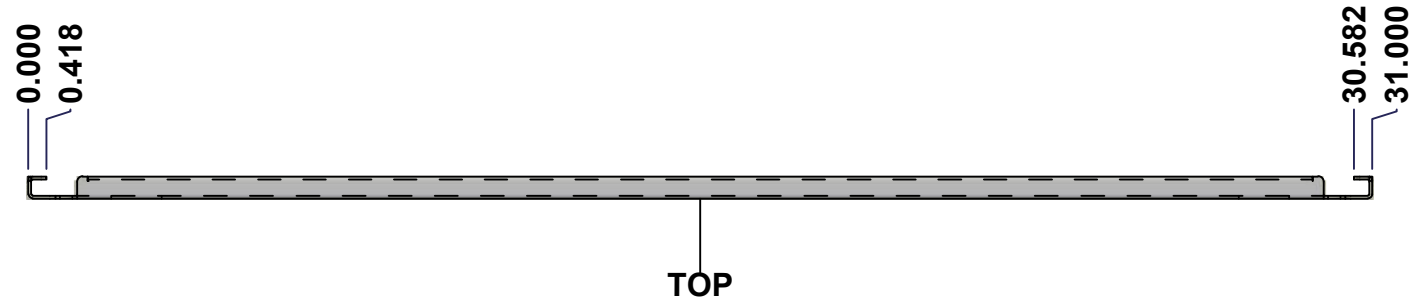

No.	Revisions	Date	By/Par

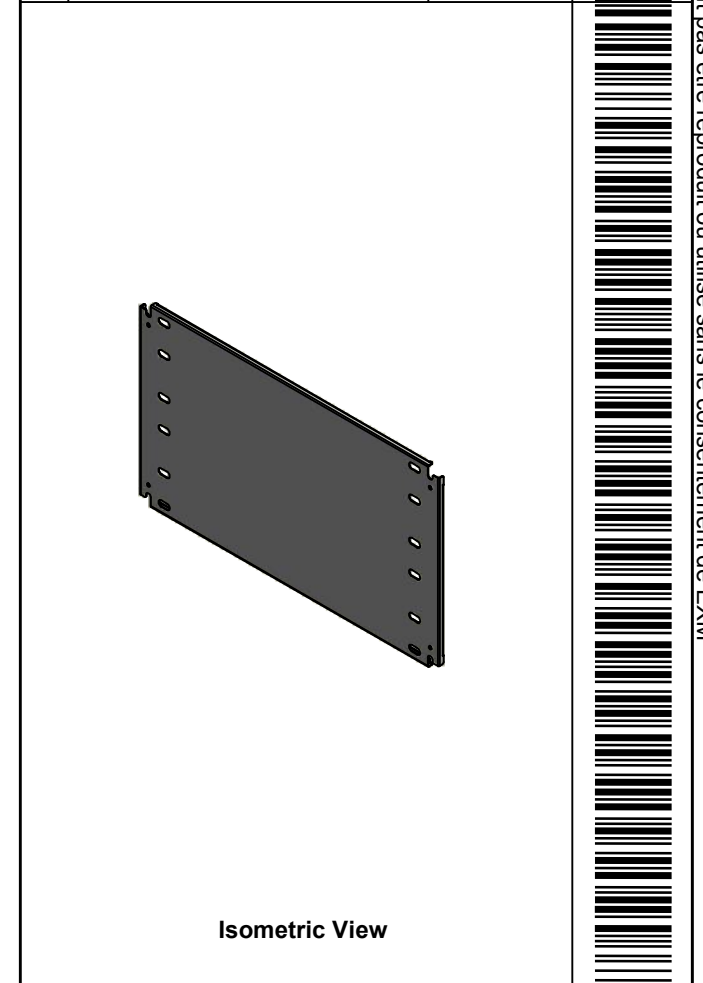

<p>Tél: (450) 979-4373 Fax: (450) 979-4626 <a href="http://www.exmweb.com">www.exmweb.com</a></p>	<p>Flatness Aplatissement</p> <p>Max 3.0mm</p> <p>Projection</p>
	<p>Customer Client</p> <p>Date</p>
<p>Drawn By Dessiné Par</p> <p>BoxCad: BoxCad</p>	<p>Date</p> <p>21-Oct-22</p>
<p>Material Matière</p> <p>14 Ga Cold Rolled A1008 CS Type B (1.7mm)</p>	
<p>Color Couleur</p> <p>White RAL9003</p>	<p>Finish Fini</p> <p>Smooth</p>
<p>Description</p> <p>1412BTCU 18.125" x 31" Right Inner Panel</p>	
<p>Detail Rev.</p>	
<p>Part Number Numéro Pièce</p> <p><b>1412BTCU101003DTIP2</b></p>	<p>Rev.</p> <p><b>0</b></p>
<p>15</p>	<p>16</p>

SEE BILL OF MATERIAL ON LAST PAGE

This drawing is confidential and must not be reproduced or used without the consent of EXM

Ce dessin est confidentiel et ne doit pas être reproduit ou utilisé sans le consentement de EXM

No.	Revisions	Date	By/Par

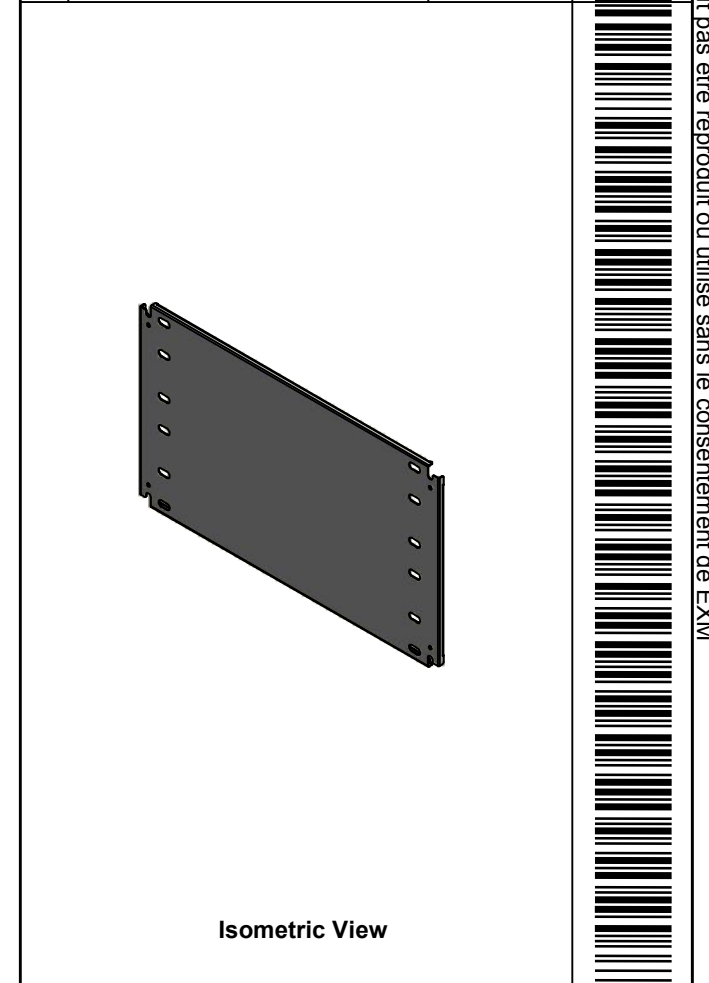

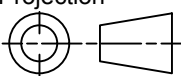
 Tél: (450) 979-4373 Fax: (450) 979-4626 <a href="http://www.exmweb.com">www.exmweb.com</a>		Flatness Aplatissement Max 3.0mm Projection 
Customer Client	Date	
Drawn By Dessiné Par	BoxCad: BoxCad	Date 21-Oct-22
Material Matière	14 Ga Cold Rolled A1008 CS Type B (1.7mm)	
Color Couleur	White RAL9003	Finish Fini Smooth
Description		Detail Rev.
1412BTCU 18.125" x 31" Right Inner Panel		
Part Number Numéro Pièce	Rev. 0	16 / 16
<b>1412BTCU101003DTIP2</b>		

Qty	Part Number	Rev	Description
1	STK-P-02401S	0	Powder Paint (White / Smooth)
1	1412BTCU101003DTIP2-P	0	1412BTCU 18.125" x 120" Right Inner Panel Part
Parts List			