

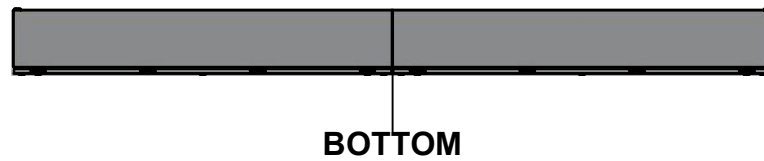

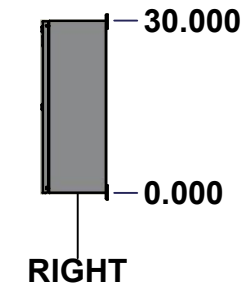

This drawing is confidential and must not be reproduced or used without the consent of EXM

Ce dessin est confidentiel et ne doit pas être reproduit ou utilisé sans le consentement de EXM

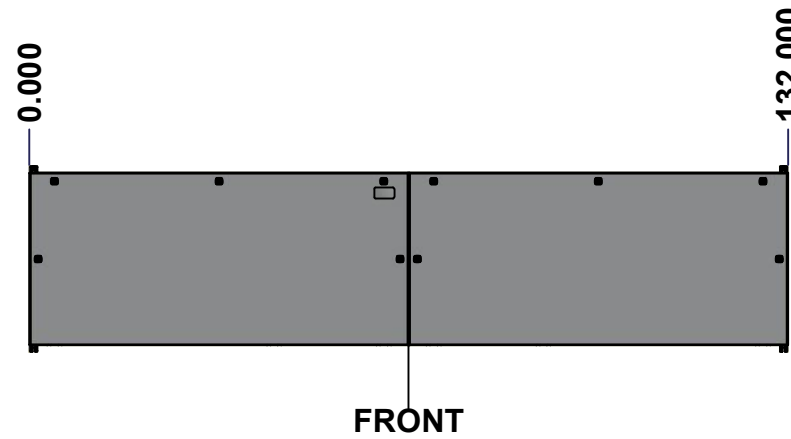
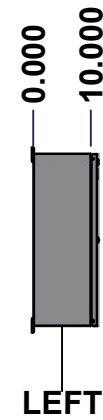
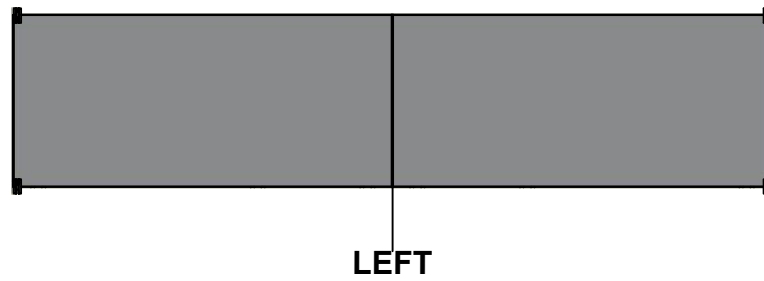
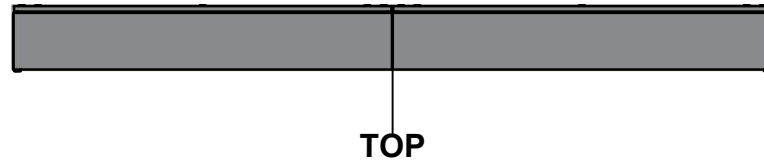
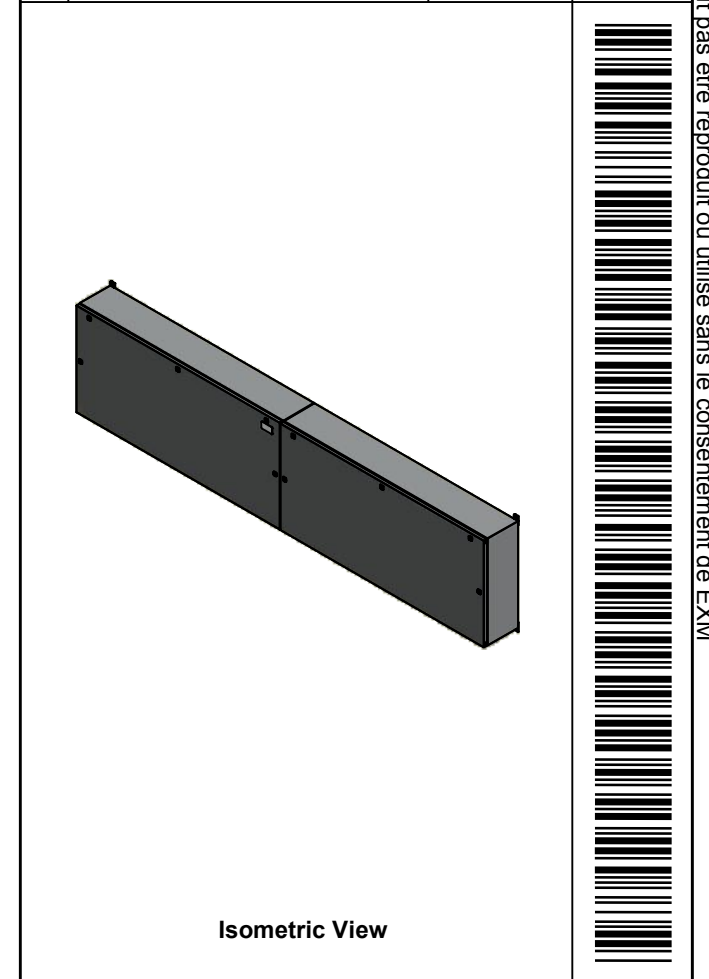

No.	Revisions	Date	By/Par

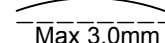

 Tél: (450) 979-4373 Fax: (450) 979-4626 www.exmweb.com		Flatness Aplatissement  Max 3.0mm
Customer Client		Projection 
Date		Date 21-Oct-22
Drawn By Dessiné Par BoxCad: BoxCad		Date 21-Oct-22
Material Matière 14 Ga Cold Rolled A1008 CS Type B (1.7mm)		
Color Couleur Asa-61 Grey	Finish Fini Smooth	
Description 1412BTCU 1200A - 4Wires x 132" Assembly		Detail Rev.
Part Number Numéro Pièce 1412BTCU111204DT		Rev. 0

SEE BILL OF MATERIAL ON LAST PAGE

This drawing is confidential and must not be reproduced or used without the consent of Eurobox

Ce dessin est confidentiel et ne doit pas être reproduit ou utilisé sans le consentement de Eurobox

STANDARD FEATURES ARE NOT LISTED IN THIS HOLE TABLE

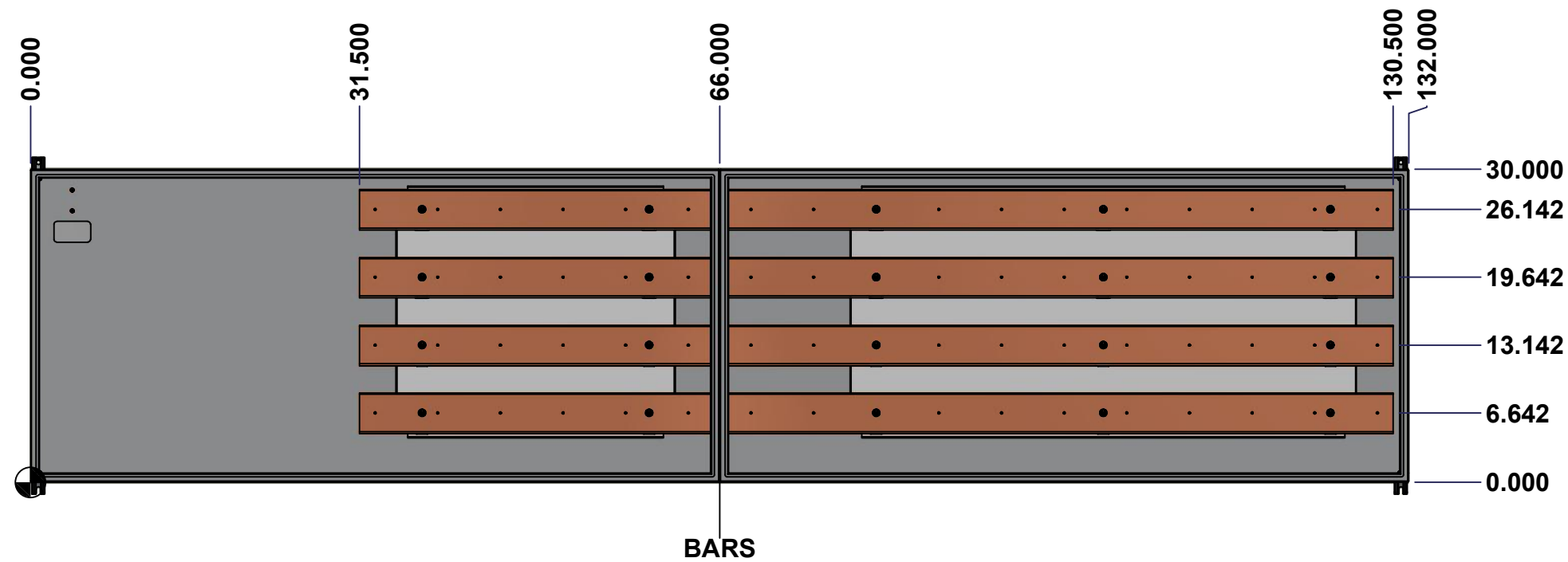

	Description 1412BTCU 1200A - 4Wires x 132" Assembly		Status (NULL)
	Part Number Numéro Pièce 1412BTCU111204DT		Rev. 2 0

This drawing is confidential and must not be reproduced or used without the consent of EXM

Ce dessin est confidentiel et ne doit pas être reproduit ou utilisé sans le consentement de EXM

NOTE	
ITEM	DESCRIPTION
1	NEMA 4/12 Enclosure
2	C/W Standard ground studs on box and cover
3	W/O Standard door stiffener
4	C/W Special inner panel (Sold separately)
5	C/W Standard inner panel mounting studs

No.	Revisions	Date	By/Par

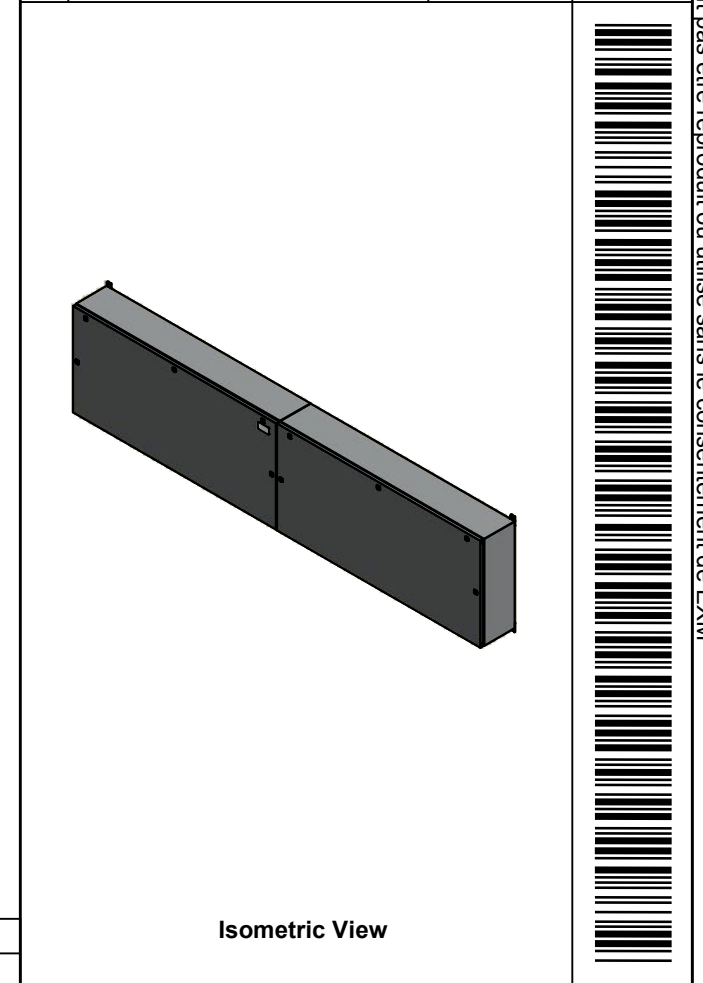

PACKING		
ITEM	QTY	DESCRIPTION
Cardboard sleeve	2	Top and Bottom
Cardboard strip	2	Between back of enclosure and inner panel
Plastic bag	1	To protect cover surface and inside gasket
Cardboard corner	4	To reinforced for the plastic strap tightening
Plastic strap - Black	2	To Squeeze 2 cardboard sleeve together
Packaging label	3	White label with PN
Plastic strap- Green	2	To secure the enclosure to the wood pallet
Wood Pallet	1	2" deeper and 3" larger than enclosure size

1	885 ESMF1	0	885 ESMF1 Mounting Feet Kit
1	1412BTCU111204DTIP2	0	1412BTCU 24.125" x 48.5" Right Inner Panel
1	1412BTCU111204DTBAR 1-P	0	Rounded Edge Copper Bar 5/16" x 4"
1	1412BTCU111204DTBAR 2-P	0	Rounded Edge Copper Bar 5/16" x 4"
1	1412BTCU111204DTBAR 3-P	0	Rounded Edge Copper Bar 5/16" x 4"
1	1412BTCU111204DTBAR 4-P	0	Rounded Edge Copper Bar 5/16" x 4"
1	1412BTCU111204DTIP1	0	1412BTCU 24.125" x 26.75" Left Inner Panel
20	STK-A-67400	0	Buss Bar Insulator Kit
1	STK-K-01800	5	5412 ES Accessory Kit
8	STK-Q-04050-07	7	M6 x 7mm Hexagon Socket Head Machine Screw with Nyseal
30	STK-Q-07310	2	Flange Lock Nut M8
10	STK-Q-07610	8	M8 Plastic Spacer 22.2mm
1	1412BTCU111204DTB	0	1412BTCU 30" x 132" x 10" Body
1	1412BTCU111204DTC	0	1412BTCU 30" x 132" Cover
Qty	Part Number	Rev	Description
Parts List			

Tél: (450) 979-4373
Fax: (450) 979-4626
www.exmweb.com

Flatness
Aplatissement
Max 3.0mm

Projection

Customer Client	Date
Drawn By Dessiné Par BoxCad: BoxCad	Date 21-Oct-22
Material Matière 14 Ga Cold Rolled A1008 CS Type B (1.7mm)	
Color Couleur Asa-61 Grey	Finish Fini Smooth
Description 1412BTCU 1200A - 4Wires x 132" Assembly	Detail Rev.
Part Number Numéro Pièce 1412BTCU111204DT	Rev. 0

This drawing is confidential and must not be reproduced or used without the consent of EXM

Ce dessin est confidentiel et ne doit pas être reproduit ou utilisé sans le consentement de EXM



TOP



BACK

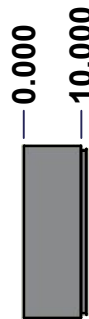

LEFT

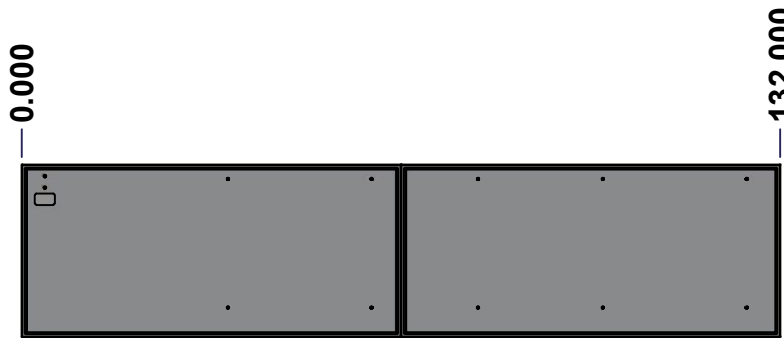

FRONT

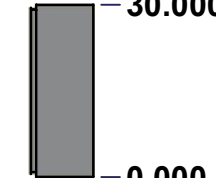

RIGHT



BOTTOM

No.	Revisions	Date	By/Par

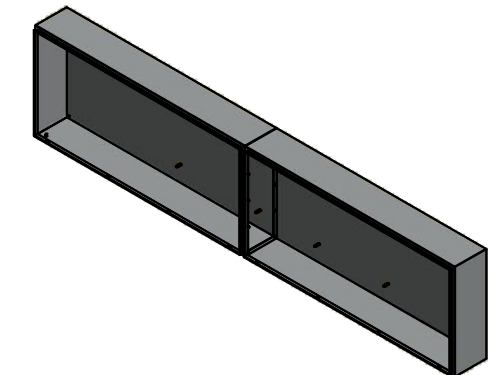

Isometric View



Tél: (450) 979-4373
 Fax: (450) 979-4626
www.exmweb.com

Flatness
Aplatissement

Max 3.0mm

Projection

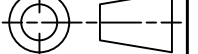

Customer Client	Date
Drawn By Dessiné Par BoxCad: BoxCad	Date 21-Oct-22
Material Matière 14 Ga Cold Rolled A1008 CS Type B (1.7mm)	
Color Couleur Asa-61 Grey	Finish Fini Smooth
Description 1412BTCU 30" x 132" x 10" Body	Detail Rev.
Part Number Numéro Pièce 1412BTCU111204DTB	Rev. 0

SEE BILL OF MATERIAL ON LAST PAGE

This drawing is confidential and must not be reproduced or used without the consent of Eurobox

Ce dessin est confidentiel et ne doit pas être reproduit ou utilisé sans le consentement de Eurobox

STANDARD FEATURES ARE NOT LISTED IN THIS HOLE TABLE

HOLE TABLE - BACK VIEW (CUSTOM FEATURE ONLY)

CUT-OUT	XDIM	YDIM	DESCRIPTION
1	128.000	28.000	GND STUD M8 x 35mm (Inside)
2	128.000	26.000	GND STUD M8 x 35mm (Inside)
3	5.875	27.500	IP STUD M8 x 35mm (Inside)
4	52.625	27.500	IP STUD M8 x 35mm (Inside)
5	5.875	5.125	IP STUD M8 x 35mm (Inside)
6	52.625	5.125	IP STUD M8 x 35mm (Inside)
7	71.125	27.500	IP STUD M8 x 35mm (Inside)
8	96.125	27.500	IP STUD M8 x 35mm (Inside)
9	71.125	5.125	IP STUD M8 x 35mm (Inside)
10	96.125	5.125	IP STUD M8 x 35mm (Inside)
11	30.875	27.500	IP STUD M8 x 35mm (Inside)
12	30.875	5.125	IP STUD M8 x 35mm (Inside)

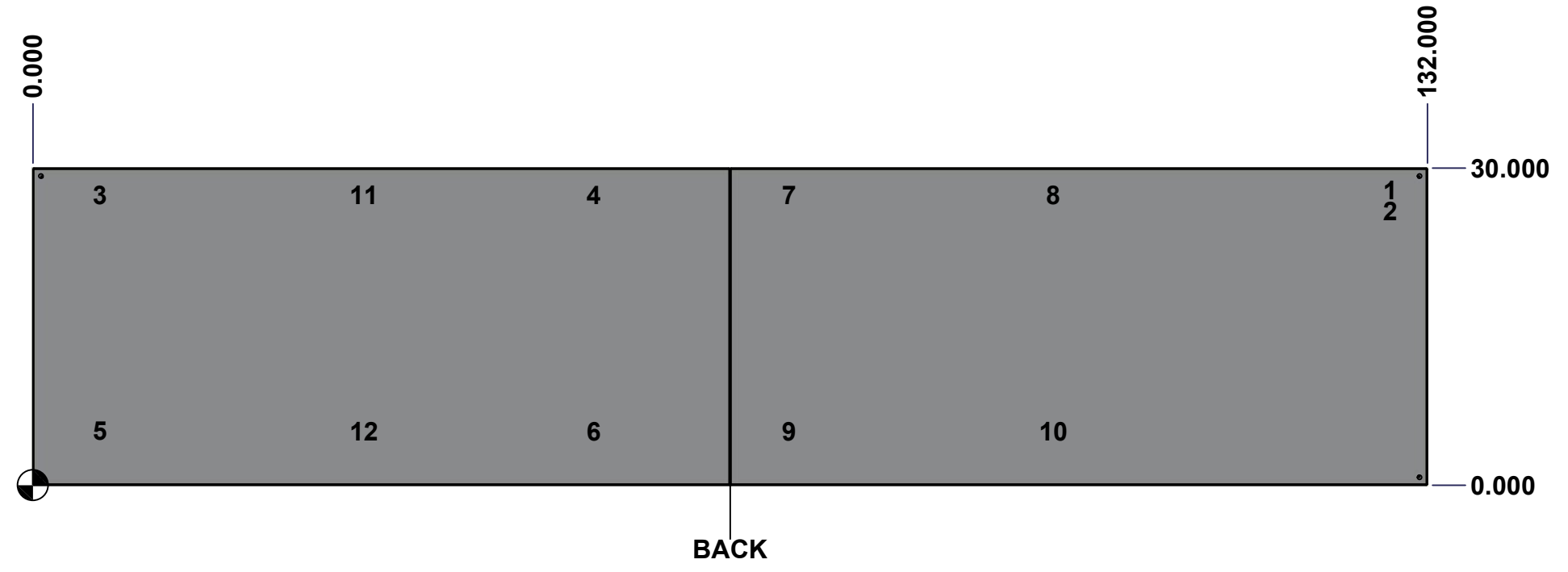

	Description	Status
	1412BTCU 30" x 132" x 10" Body	(NULL)
	Part Number Numéro Pièce	Rev.
	1412BTCU111204DTB	0 / 5
		17

This drawing is confidential and must not be reproduced or used without the consent of EXM

Ce dessin est confidentiel et ne doit pas être reproduit ou utilisé sans le consentement de EXM

No.	Revisions	Date	By/Par

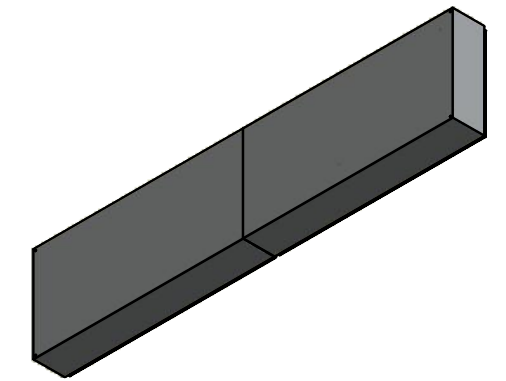

Isometric View

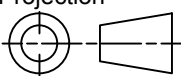

 Tél: (450) 979-4373 Fax: (450) 979-4626 www.exmweb.com	Flatness Aplatissement	Max 3.0mm
	Projection	
Customer Client	Date	
Drawn By Dessiné Par	BoxCad: BoxCad	Date 21-Oct-22
Material Matière	14 Ga Cold Rolled A1008 CS Type B (1.7mm)	
Color Couleur	Asa-61 Grey	Finish Fini Smooth
Description	Detail Rev.	
1412BTCU 30" x 132" x 10" Body		
Part Number Numéro Pièce	Rev. 0	6
1412BTCU111204DTB		17

Qty	Part Number	Rev	Description
1	STK-P-02400S	0	Powder Paint (Asa-61 Grey / Smooth)
1	1412BTCU111204DTB-P	0	1412BTCU 30" x 132" x 10" Left Body Part
1	1412BTCU111204DTE-P	0	1412BTCU 30" x 132" x 10" Right Body Part
1	STK-G-00701	0	1" x 1/4" Self-Adhesive Neoprene Gasket
10	STK-Q-00260	1	M6 x 13mm Carriage Bolt
10	STK-Q-07220	1	M6 Nylon Insert Lock Nut
12	STK-Q-16005	1	Stud M8 x 35 (No Paint Cap Required)
2	STK-Q-16080	0	Ground Stud M6 x 16mm
1	STK-S-00100	0	3.5" x 2" Silver Milar Flexcon Sticker
Parts List			

This drawing is confidential and must not be reproduced or used without the consent of Eurobex

Ce dessin est confidentiel et ne doit pas être reproduit ou utilisé sans le consentement de Eurobex

STANDARD FEATURES ARE NOT LISTED IN THIS HOLE TABLE			
HOLE TABLE - FRONT VIEW (CUSTOM FEATURE ONLY)			
CUT-OUT	XDIM	YDIM	DESCRIPTION
1	97.500	2.000	RND Ø0.201 THREAD 1/4-20 UNC
2	91.500	2.000	RND Ø0.201 THREAD 1/4-20 UNC
3	85.500	2.000	RND Ø0.201 THREAD 1/4-20 UNC
4	79.500	2.000	RND Ø0.201 THREAD 1/4-20 UNC
5	73.500	2.000	RND Ø0.201 THREAD 1/4-20 UNC
6	67.500	2.000	RND Ø0.201 THREAD 1/4-20 UNC
7	61.500	2.000	RND Ø0.201 THREAD 1/4-20 UNC
8	55.500	2.000	RND Ø0.201 THREAD 1/4-20 UNC
9	43.500	2.000	RND Ø0.201 THREAD 1/4-20 UNC
10	37.500	2.000	RND Ø0.201 THREAD 1/4-20 UNC
11	31.500	2.000	RND Ø0.201 THREAD 1/4-20 UNC
12	25.500	2.000	RND Ø0.201 THREAD 1/4-20 UNC
13	19.500	2.000	RND Ø0.201 THREAD 1/4-20 UNC
14	13.500	2.000	RND Ø0.201 THREAD 1/4-20 UNC
15	7.500	2.000	RND Ø0.201 THREAD 1/4-20 UNC
16	1.500	2.000	RND Ø0.201 THREAD 1/4-20 UNC

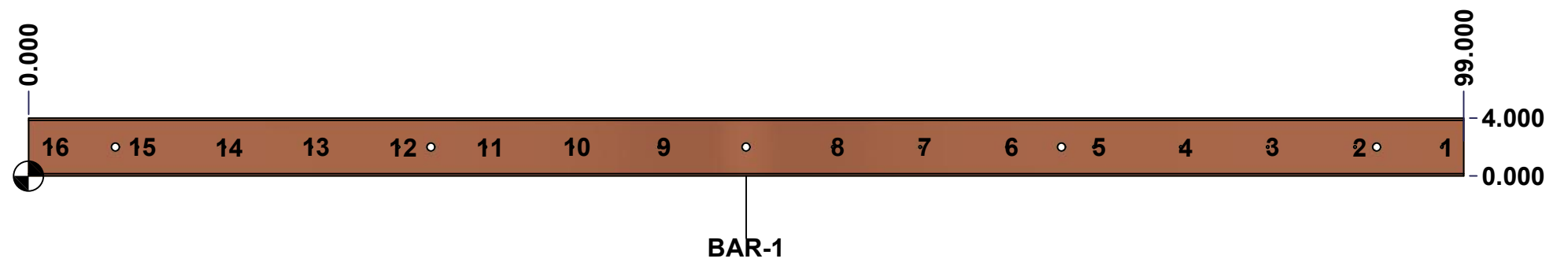

	Description	Status	
	Rounded Edge Copper Bar 5/16" x 4"	(NULL)	
	Part Number Numéro Pièce	Rev.	7
	1412BTCU111204DTBAR1-P	0	17

This drawing is confidential and must not be reproduced or used without the consent of Eurobex

Ce dessin est confidentiel et ne doit pas être reproduit ou utilisé sans le consentement de Eurobex

STANDARD FEATURES ARE NOT LISTED IN THIS HOLE TABLE			
HOLE TABLE - FRONT VIEW (CUSTOM FEATURE ONLY)			
CUT-OUT	XDIM	YDIM	DESCRIPTION
1	97.500	2.000	RND Ø0.201 THREAD 1/4-20 UNC
2	91.500	2.000	RND Ø0.201 THREAD 1/4-20 UNC
3	85.500	2.000	RND Ø0.201 THREAD 1/4-20 UNC
4	79.500	2.000	RND Ø0.201 THREAD 1/4-20 UNC
5	73.500	2.000	RND Ø0.201 THREAD 1/4-20 UNC
6	67.500	2.000	RND Ø0.201 THREAD 1/4-20 UNC
7	61.500	2.000	RND Ø0.201 THREAD 1/4-20 UNC
8	55.500	2.000	RND Ø0.201 THREAD 1/4-20 UNC
9	43.500	2.000	RND Ø0.201 THREAD 1/4-20 UNC
10	37.500	2.000	RND Ø0.201 THREAD 1/4-20 UNC
11	31.500	2.000	RND Ø0.201 THREAD 1/4-20 UNC
12	25.500	2.000	RND Ø0.201 THREAD 1/4-20 UNC
13	19.500	2.000	RND Ø0.201 THREAD 1/4-20 UNC
14	13.500	2.000	RND Ø0.201 THREAD 1/4-20 UNC
15	7.500	2.000	RND Ø0.201 THREAD 1/4-20 UNC
16	1.500	2.000	RND Ø0.201 THREAD 1/4-20 UNC

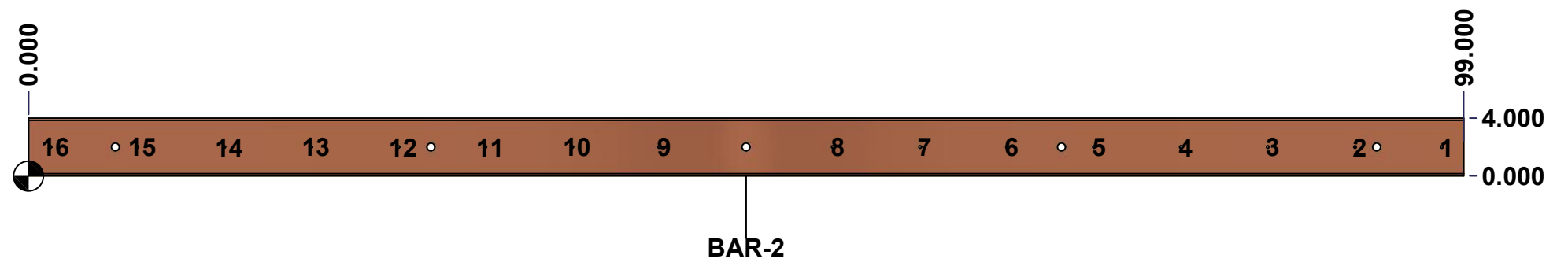

	Description	Status
	Rounded Edge Copper Bar 5/16" x 4"	(NULL)
	Part Number Numéro Pièce	Rev.
	1412BTCU111204DTBAR2-P	0
		8
		17

This drawing is confidential and must not be reproduced or used without the consent of Eurobex

Ce dessin est confidentiel et ne doit pas être reproduit ou utilisé sans le consentement de Eurobex

STANDARD FEATURES ARE NOT LISTED IN THIS HOLE TABLE			
HOLE TABLE - FRONT VIEW (CUSTOM FEATURE ONLY)			
CUT-OUT	XDIM	YDIM	DESCRIPTION
1	97.500	2.000	RND Ø0.201 THREAD 1/4-20 UNC
2	91.500	2.000	RND Ø0.201 THREAD 1/4-20 UNC
3	85.500	2.000	RND Ø0.201 THREAD 1/4-20 UNC
4	79.500	2.000	RND Ø0.201 THREAD 1/4-20 UNC
5	73.500	2.000	RND Ø0.201 THREAD 1/4-20 UNC
6	67.500	2.000	RND Ø0.201 THREAD 1/4-20 UNC
7	61.500	2.000	RND Ø0.201 THREAD 1/4-20 UNC
8	55.500	2.000	RND Ø0.201 THREAD 1/4-20 UNC
9	43.500	2.000	RND Ø0.201 THREAD 1/4-20 UNC
10	37.500	2.000	RND Ø0.201 THREAD 1/4-20 UNC
11	31.500	2.000	RND Ø0.201 THREAD 1/4-20 UNC
12	25.500	2.000	RND Ø0.201 THREAD 1/4-20 UNC
13	19.500	2.000	RND Ø0.201 THREAD 1/4-20 UNC
14	13.500	2.000	RND Ø0.201 THREAD 1/4-20 UNC
15	7.500	2.000	RND Ø0.201 THREAD 1/4-20 UNC
16	1.500	2.000	RND Ø0.201 THREAD 1/4-20 UNC

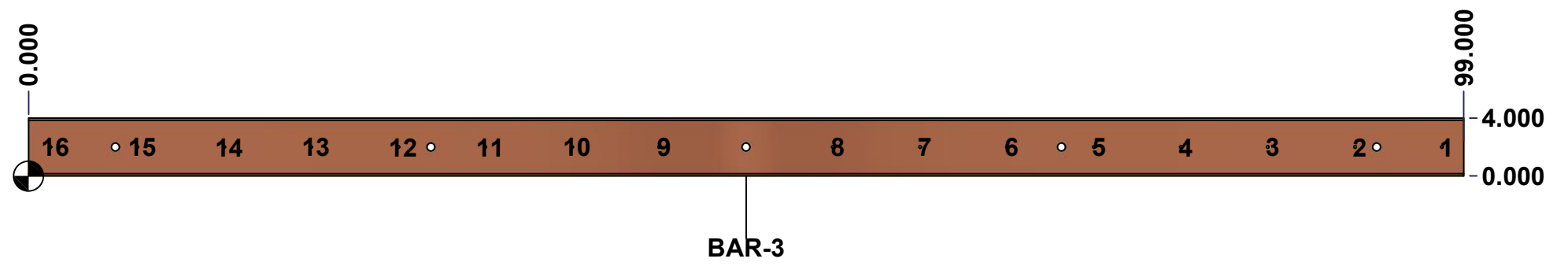

	Description	Status
	Rounded Edge Copper Bar 5/16" x 4"	(NULL)
	Part Number	Rev.
	1412BTCU111204DTBAR3-P	9
		17

This drawing is confidential and must not be reproduced or used without the consent of Eurobex

Ce dessin est confidentiel et ne doit pas être reproduit ou utilisé sans le consentement de Eurobex

STANDARD FEATURES ARE NOT LISTED IN THIS HOLE TABLE			
HOLE TABLE - FRONT VIEW (CUSTOM FEATURE ONLY)			
CUT-OUT	XDIM	YDIM	DESCRIPTION
1	97.500	2.000	RND Ø0.201 THREAD 1/4-20 UNC
2	91.500	2.000	RND Ø0.201 THREAD 1/4-20 UNC
3	85.500	2.000	RND Ø0.201 THREAD 1/4-20 UNC
4	79.500	2.000	RND Ø0.201 THREAD 1/4-20 UNC
5	73.500	2.000	RND Ø0.201 THREAD 1/4-20 UNC
6	67.500	2.000	RND Ø0.201 THREAD 1/4-20 UNC
7	61.500	2.000	RND Ø0.201 THREAD 1/4-20 UNC
8	55.500	2.000	RND Ø0.201 THREAD 1/4-20 UNC
9	43.500	2.000	RND Ø0.201 THREAD 1/4-20 UNC
10	37.500	2.000	RND Ø0.201 THREAD 1/4-20 UNC
11	31.500	2.000	RND Ø0.201 THREAD 1/4-20 UNC
12	25.500	2.000	RND Ø0.201 THREAD 1/4-20 UNC
13	19.500	2.000	RND Ø0.201 THREAD 1/4-20 UNC
14	13.500	2.000	RND Ø0.201 THREAD 1/4-20 UNC
15	7.500	2.000	RND Ø0.201 THREAD 1/4-20 UNC
16	1.500	2.000	RND Ø0.201 THREAD 1/4-20 UNC

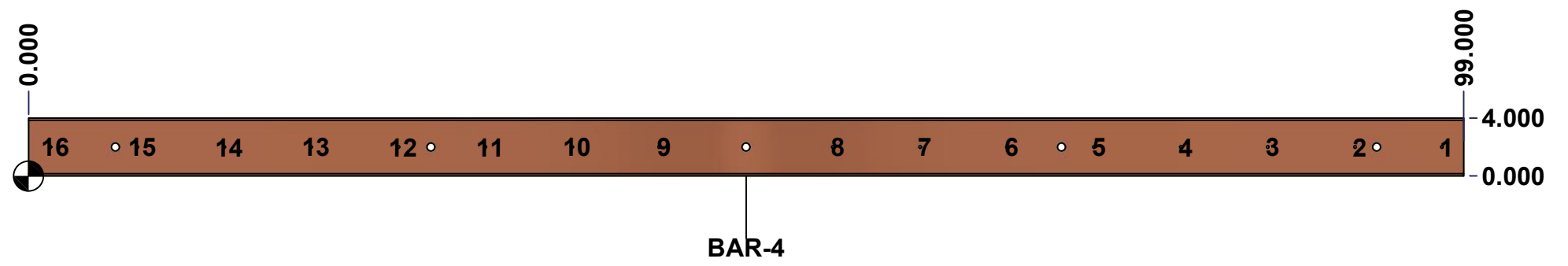

	Description	Status	
	Rounded Edge Copper Bar 5/16" x 4"	(NULL)	
	Part Number Numéro Pièce	Rev.	10
	1412BTCU111204DTBAR4-P	0	17

This drawing is confidential and must not be reproduced or used without the consent of EXM

Ce dessin est confidentiel et ne doit pas être reproduit ou utilisé sans le consentement de EXM

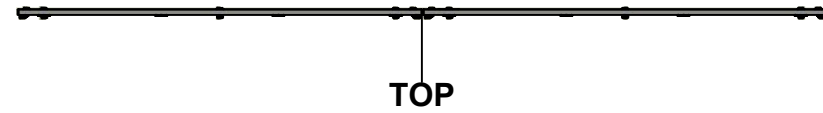

TOP

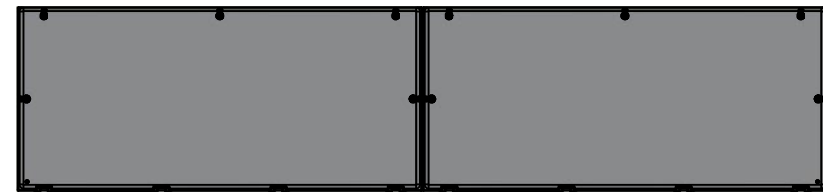

BACK



LEFT

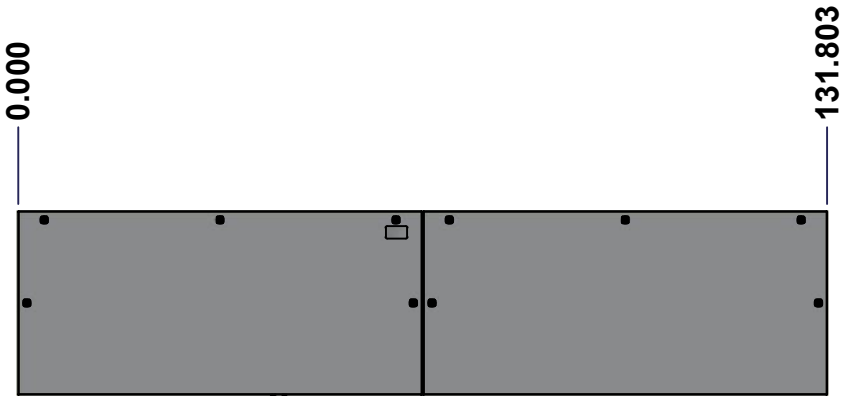

FRONT

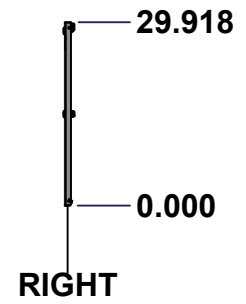

RIGHT



BOTTOM

No.	Revisions	Date	By/Par

Isometric View

Tél: (450) 979-4373 Fax: (450) 979-4626 www.exmweb.com		Flatness Aplatissement
		Max 3.0mm
Customer Client		Date
Drawn By Dessiné Par BoxCad: BoxCad		Date 21-Oct-22
Material Matière 14 Ga Cold Rolled A1008 CS Type B (1.7mm)		
Color Couleur	Asa-61 Grey	Finish Fini Smooth
Description 1412BTCU 30" x 132" Cover		Detail Rev.
Part Number Numéro Pièce 1412BTCU111204DTC		Rev. 11 0

SEE BILL OF MATERIAL ON LAST PAGE

This drawing is confidential and must not be reproduced or used without the consent of Eurobox

Ce dessin est confidentiel et ne doit pas être reproduit ou utilisé sans le consentement de Eurobox

STANDARD FEATURES ARE NOT LISTED IN THIS HOLE TABLE

HOLE TABLE - FRONT VIEW (CUSTOM FEATURE ONLY)

CUT-OUT	XDIM	YDIM	DESCRIPTION
1	1.500	1.486	GND STUD M6 x 16mm (Inside)
2	130.303	1.486	GND STUD M6 x 16mm (Inside)
3	130.379	14.959	LOCK 880 SCQ4-SL @ 0.0°
4	67.424	14.959	LOCK 880 SCQ4-SL @ 180.0°
5	64.379	14.959	LOCK 880 SCQ4-SL @ 0.0°
6	1.424	14.959	LOCK 880 SCQ4-SL @ 180.0°
7	127.553	28.494	LOCK 880 SCQ4-SL @ 90.0°
8	98.902	28.494	LOCK 880 SCQ4-SL @ 90.0°
9	70.250	28.494	LOCK 880 SCQ4-SL @ 90.0°
10	61.553	28.494	LOCK 880 SCQ4-SL @ 90.0°
11	32.902	28.494	LOCK 880 SCQ4-SL @ 90.0°
12	4.250	28.494	LOCK 880 SCQ4-SL @ 90.0°

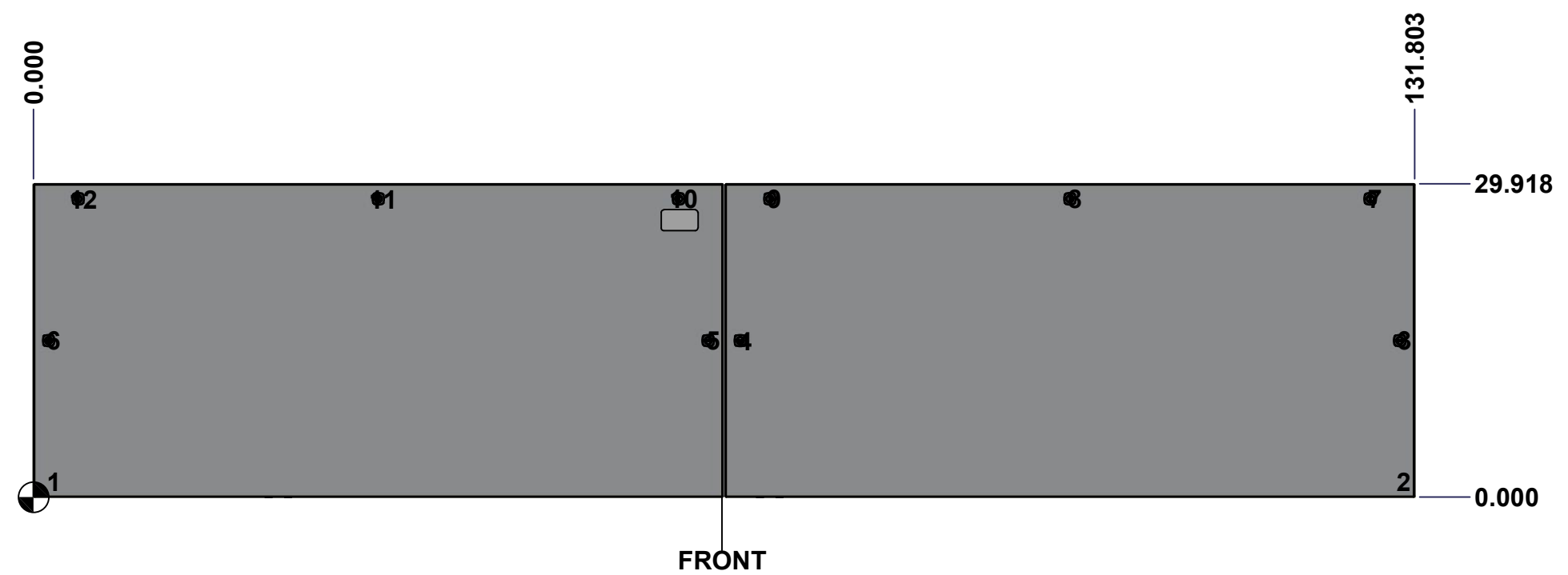

	Description	Status
	1412BTCU 30" x 132" Cover	(NULL)
	Part Number Numéro Pièce	Rev.
	1412BTCU111204DTC	0 / 12
		17

This drawing is confidential and must not be reproduced or used without the consent of EXM

Ce dessin est confidentiel et ne doit pas être reproduit ou utilisé sans le consentement de EXM

No.	Revisions	Date	By/Par

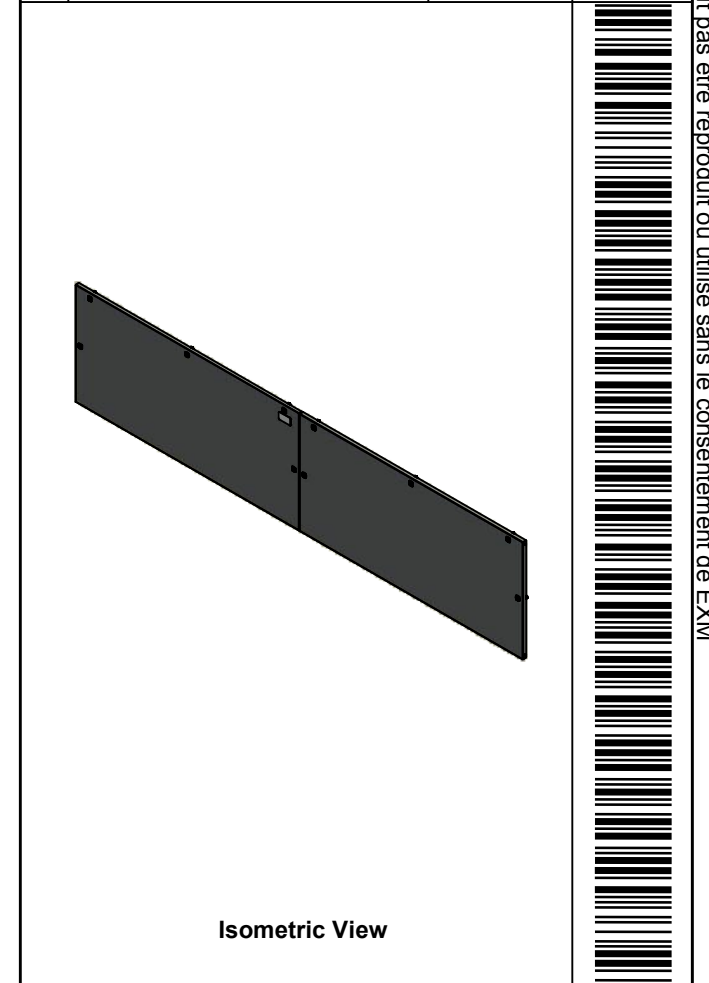

Isometric View

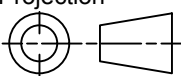
 Tél: (450) 979-4373 Fax: (450) 979-4626 www.exmweb.com		Flatness Aplatissement Max 3.0mm
Customer Client		Projection 
Drawn By / Dessiné Par: BoxCad: BoxCad		Date: 21-Oct-22
Material / Matière: 14 Ga Cold Rolled A1008 CS Type B (1.7mm)		
Color / Couleur: Asa-61 Grey	Finish / Fini: Smooth	
Description: 1412BTCU 30" x 132" Cover		Detail Rev.
Part Number / Numéro Pièce: 1412BTCU111204DTC		Rev. 13 / 17 0

Qty	Part Name	Rev	Description
2	1412BTCU111204DTG	0	1412BTCU 30" x 132" Cover Gasket
1	STK-P-02400S	0	Powder Paint (Asa-61 Grey / Smooth)
8	STK-K-09800	10	5412 ES Hinge with 2 Captive Hinge Pins
2	STK-Q-16080	0	Ground Stud M6 x 16mm
1	STK-S-00100	0	3.5" x 2" Silver Milar Flexcon Sticker
1	1412BTCU111204DTC-P	0	1412BTCU 30" x 66" Left Cover Part
1	1412BTCU111204DTF-P	0	1412BTCU 30" x 132" Right Cover Part
10	880 SCQ4-SL	6	5412 ES 1/4 Turn Lock
Parts List			

This drawing is confidential and must not be reproduced or used without the consent of EXM

Ce dessin est confidentiel et ne doit pas être reproduit ou utilisé sans le consentement de EXM

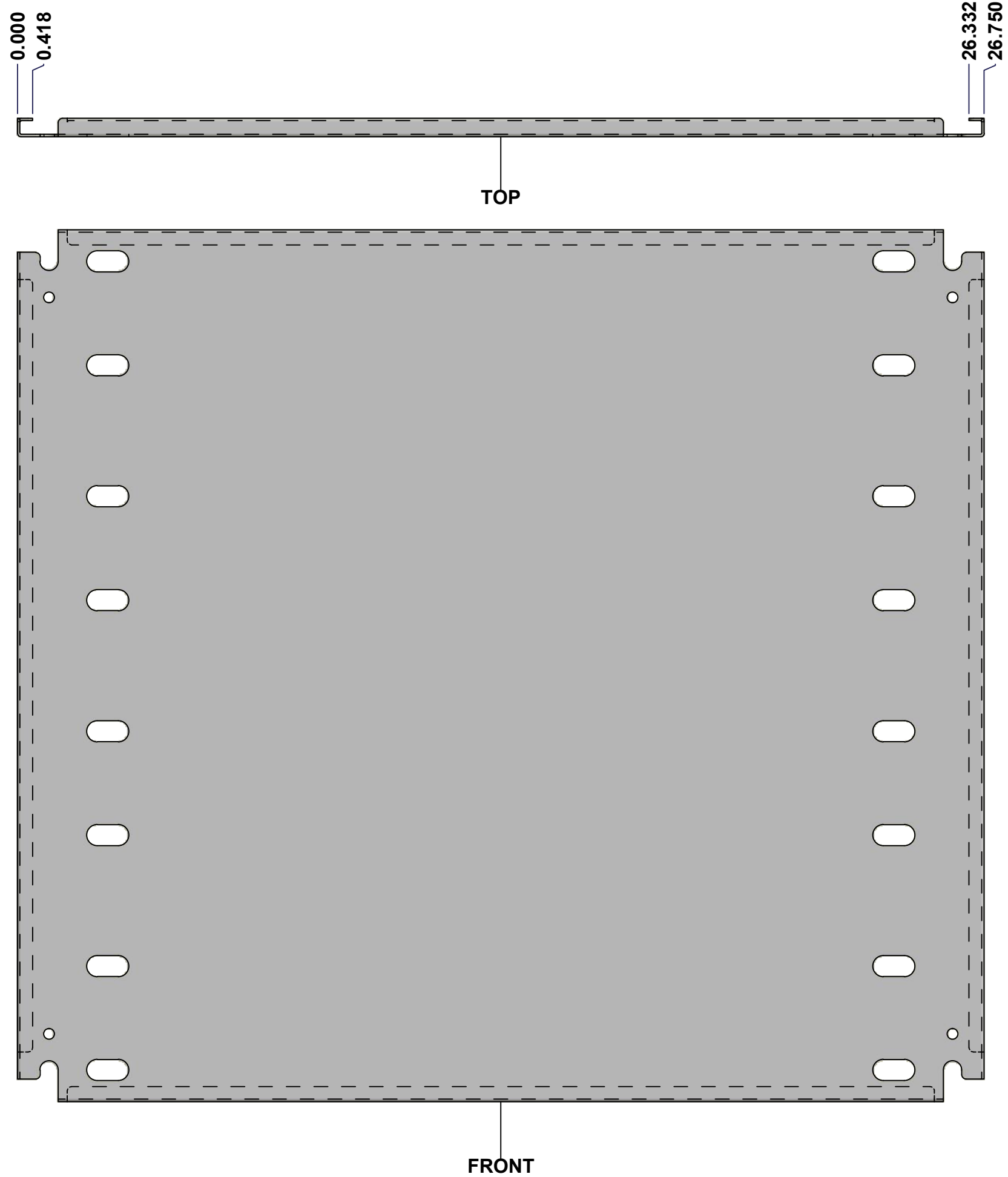

SEE BILL OF MATERIAL ON LAST PAGE

No.	Revisions	Date	By/Par

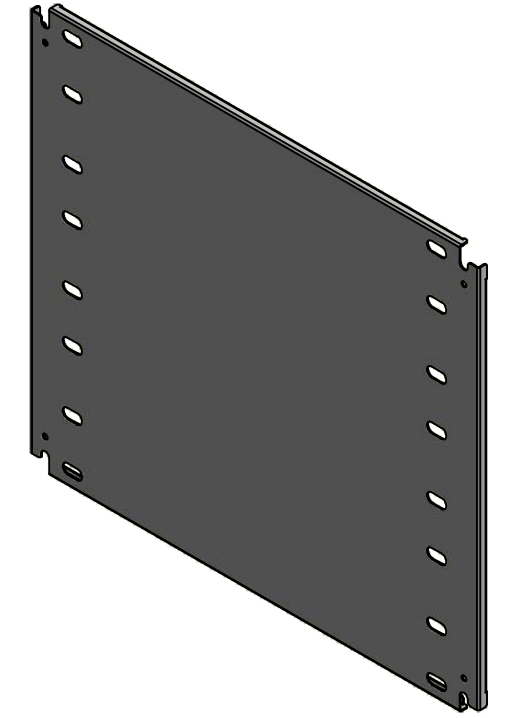

Isometric View





<p>Tél: (450) 979-4373 Fax: (450) 979-4626 www.exmweb.com</p>	<p>Flatness Aplatissement</p> <p>Max 3.0mm</p>
	<p>Projection</p>
Customer Client	Date
Drawn By Dessiné Par BoxCad: BoxCad	Date 21-Oct-22
Material Matière 14 Ga Cold Rolled A1008 CS Type B (1.7mm)	
Color Couleur White RAL9003	Finish Fini Smooth
Description 1412BTCU 24.125" x 26.75" Left Inner Panel	
Part Number Numéro Pièce 1412BTCU111204DTIP1	Detail Rev. Rev. 14 0

This drawing is confidential and must not be reproduced or used without the consent of EXM

Ce dessin est confidentiel et ne doit pas être reproduit ou utilisé sans le consentement de EXM

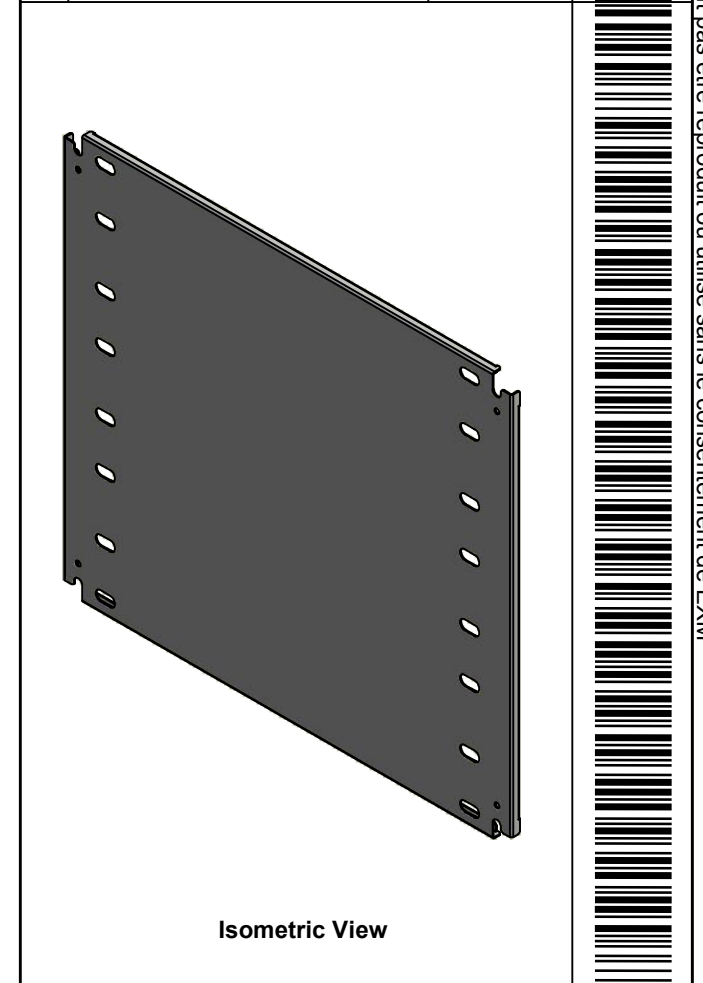
No.	Revisions	Date	By/Par

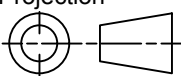

 Tél: (450) 979-4373 Fax: (450) 979-4626 www.exmweb.com		Flatness Aplatissement Max 3.0mm Projection 
Customer Client	Date	
Drawn By Dessiné Par	BoxCad: BoxCad	Date 21-Oct-22
Material Matière	14 Ga Cold Rolled A1008 CS Type B (1.7mm)	
Color Couleur	White RAL9003	Finish Fini Smooth
Description		Detail Rev.
1412BTCU 24.125" x 26.75" Left Inner Panel		
Part Number Numéro Pièce	Rev. 0	15 / 17
1412BTCU111204DTIP1		

Qty	Part Number	Rev	Description
1	STK-P-02401S	0	Powder Paint (White / Smooth)
1	1412BTCU111204DTIP1-P	0	1412BTCU 24.125" x 132" Left Inner Panel Part
Parts List			

This drawing is confidential and must not be reproduced or used without the consent of EXM

Ce dessin est confidentiel et ne doit pas être reproduit ou utilisé sans le consentement de EXM

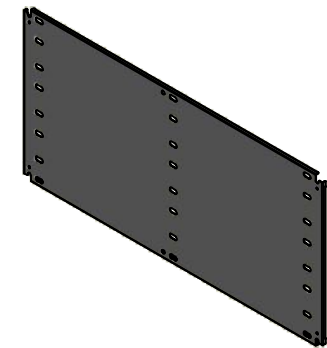
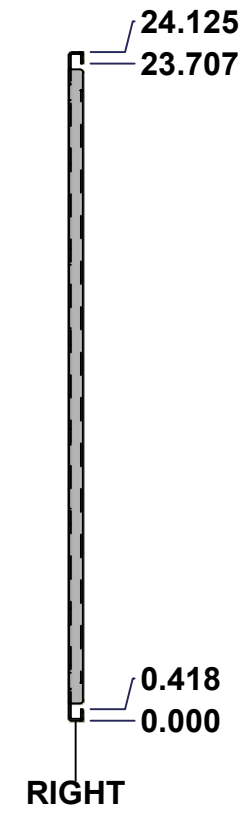
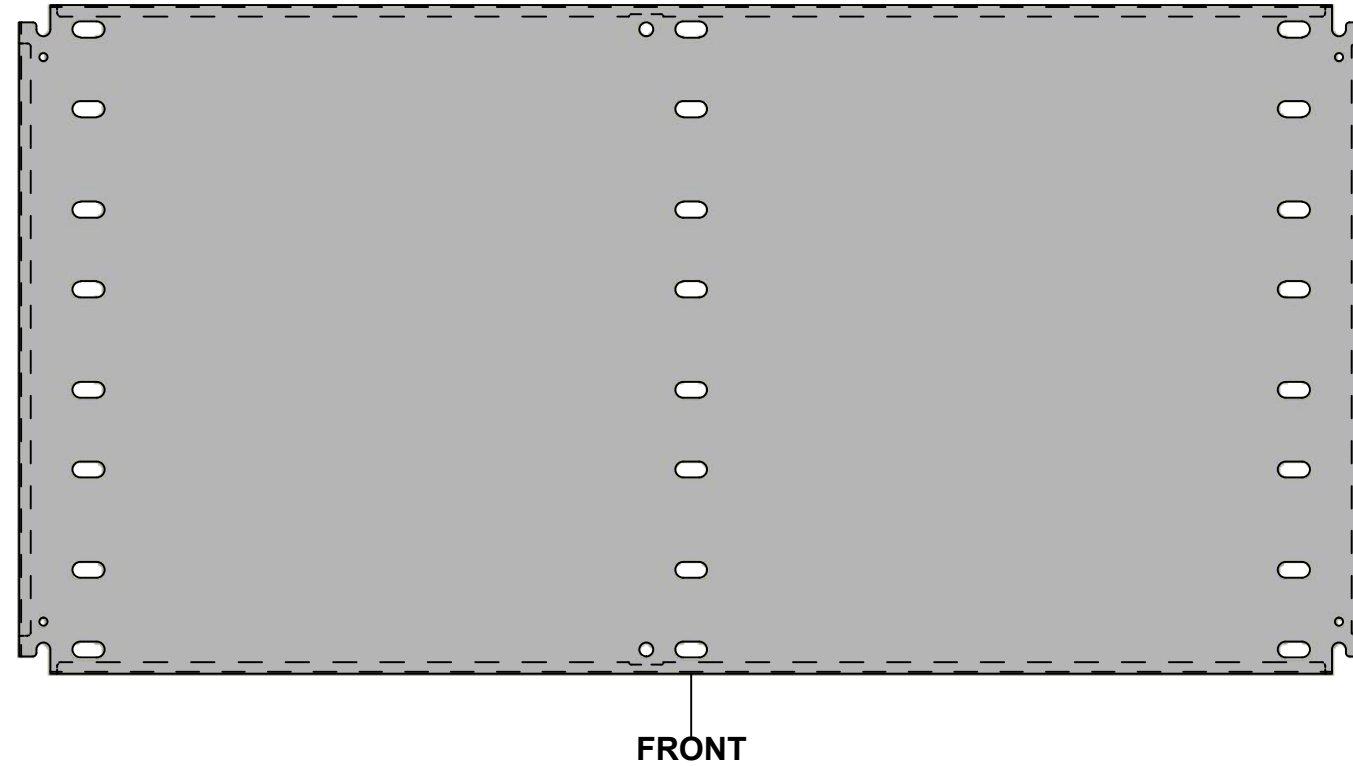
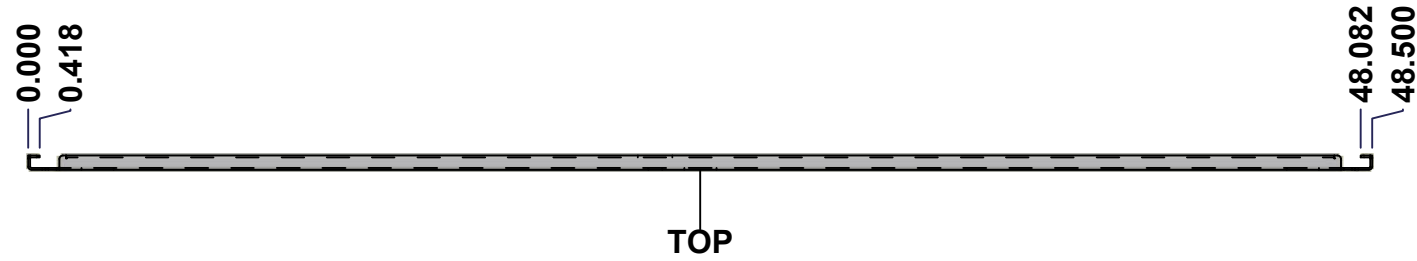

Isometric View

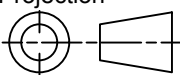

No.	Revisions	Date	By/Par

 Tél: (450) 979-4373 Fax: (450) 979-4626 www.exmweb.com		Flatness Aplatissement Max 3.0mm Projection 
Customer Client	Date	
Drawn By Dessiné Par	BoxCad: BoxCad	Date 21-Oct-22
Material Matière	14 Ga Cold Rolled A1008 CS Type B (1.7mm)	
Color Couleur	White RAL9003	Finish Fini Smooth
Description 1412BTCU 24.125" x 48.5" Right Inner Panel		Detail Rev.
Part Number Numéro Pièce	1412BTCU111204DTIP2	Rev. 16 0 17

SEE BILL OF MATERIAL ON LAST PAGE

This drawing is confidential and must not be reproduced or used without the consent of EXM

Ce dessin est confidentiel et ne doit pas être reproduit ou utilisé sans le consentement de EXM

No.	Revisions	Date	By/Par

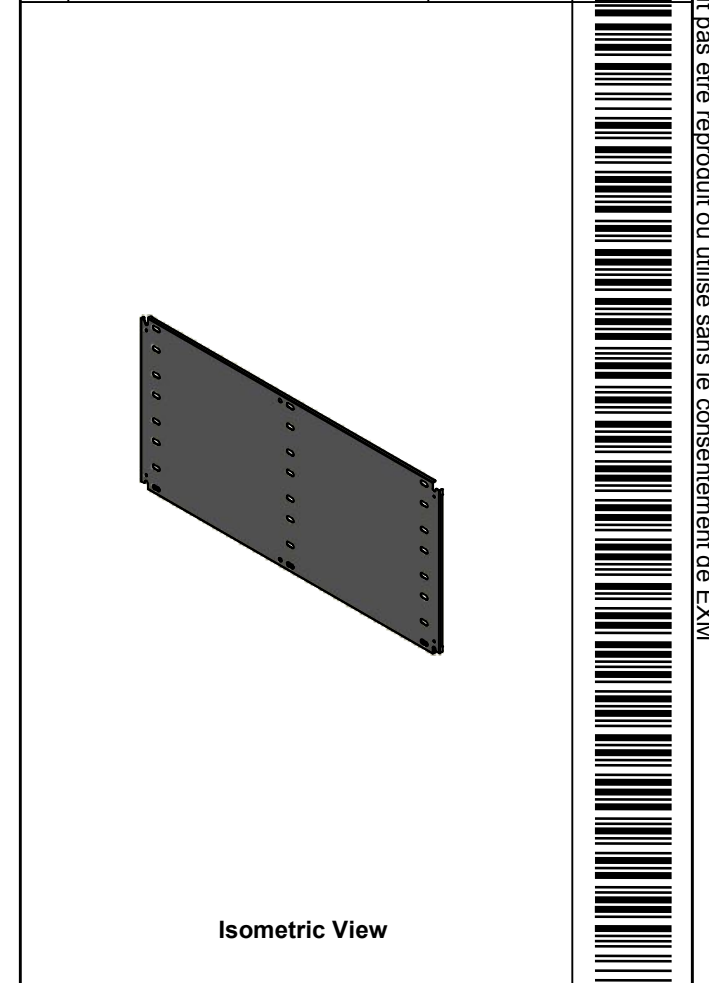

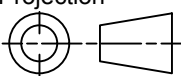
 Tél: (450) 979-4373 Fax: (450) 979-4626 www.exmweb.com		Flatness Aplatissement Max 3.0mm Projection 
Customer Client	Date	
Drawn By Dessiné Par	BoxCad: BoxCad	Date 21-Oct-22
Material Matière	14 Ga Cold Rolled A1008 CS Type B (1.7mm)	
Color Couleur	White RAL9003	Finish Fini Smooth
Description 1412BTCU 24.125" x 48.5" Right Inner Panel		Detail Rev.
Part Number Numéro Pièce	1412BTCU111204DTIP2	Rev. 17
Parts List		0 17

Qty	Part Number	Rev	Description
1	STK-P-02401S	0	Powder Paint (White / Smooth)
1	1412BTCU111204DTIP2-P	0	1412BTCU 24.125" x 132" Right Inner Panel Part