

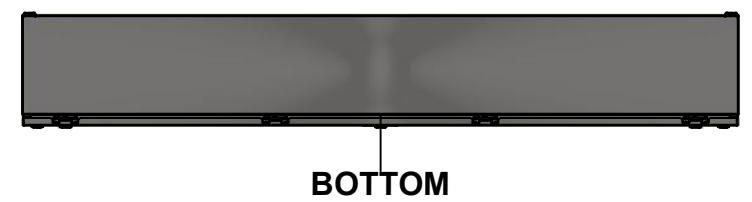

This drawing is confidential and must not be reproduced or used without the consent of EXM

Ce dessin est confidentiel et ne doit pas être reproduit ou utilisé sans le consentement de EXM

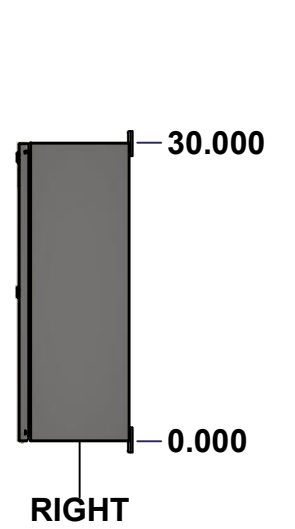
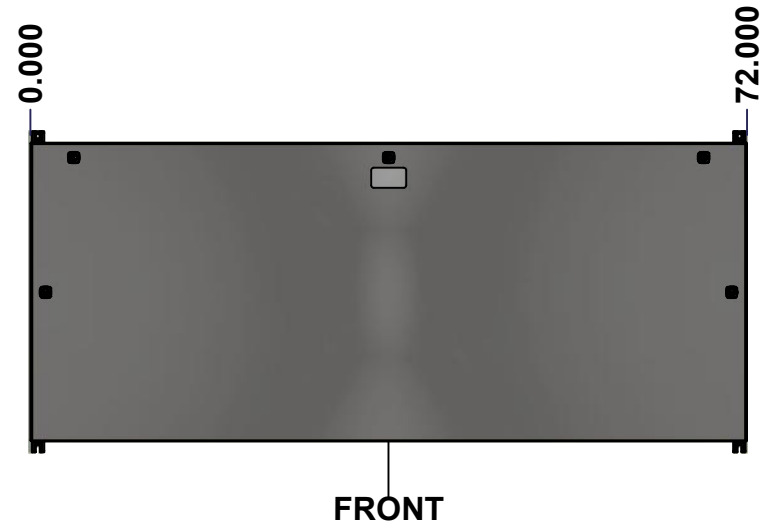
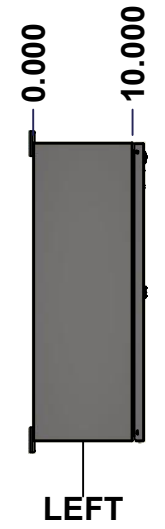
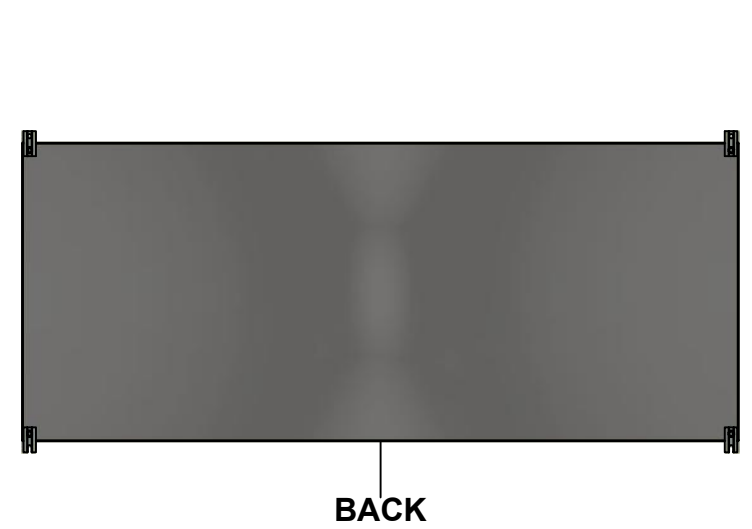
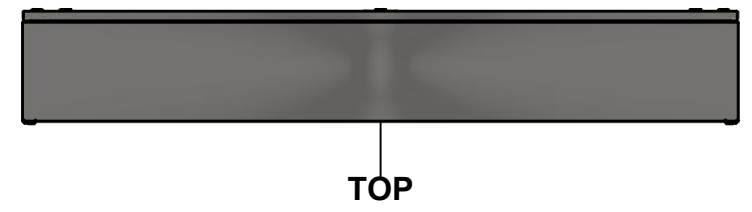
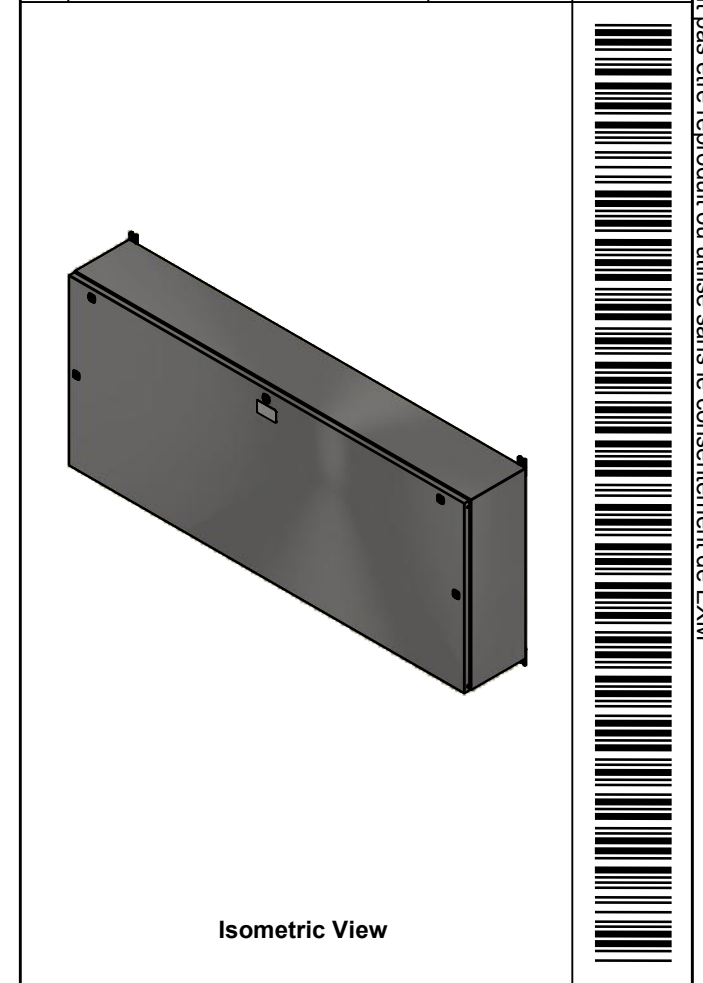

No.	Revisions	Date	By/Par

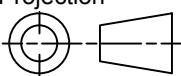

 Tél: (450) 979-4373 Fax: (450) 979-4626 <a href="http://www.exmweb.com">www.exmweb.com</a>		Flatness Aplatissement
		Max 3.0mm
Projection 		
Customer Client	Date	
Drawn By Dessiné Par	BoxCad: BoxCad	Date 01-Nov-22
Material Matière	14 Ga Stainless Steel 304 (1.7mm)	
Color Couleur	Unpainted	Finish Fini Brushed
Description	Detail Rev.	
1412BTSS 1200A - 4Wires x 72" Assembly		
Part Number Numéro Pièce	Rev.	1
<b>1412BTSS061204DT</b>	<b>0</b>	15

**SEE BILL OF MATERIAL ON LAST PAGE**

This drawing is confidential and must not be reproduced or used without the consent of Eurobox

**STANDARD FEATURES ARE NOT LISTED IN THIS HOLE TABLE**

Ce dessin est confidentiel et ne doit pas être reproduit ou utilisé sans le consentement de Eurobox

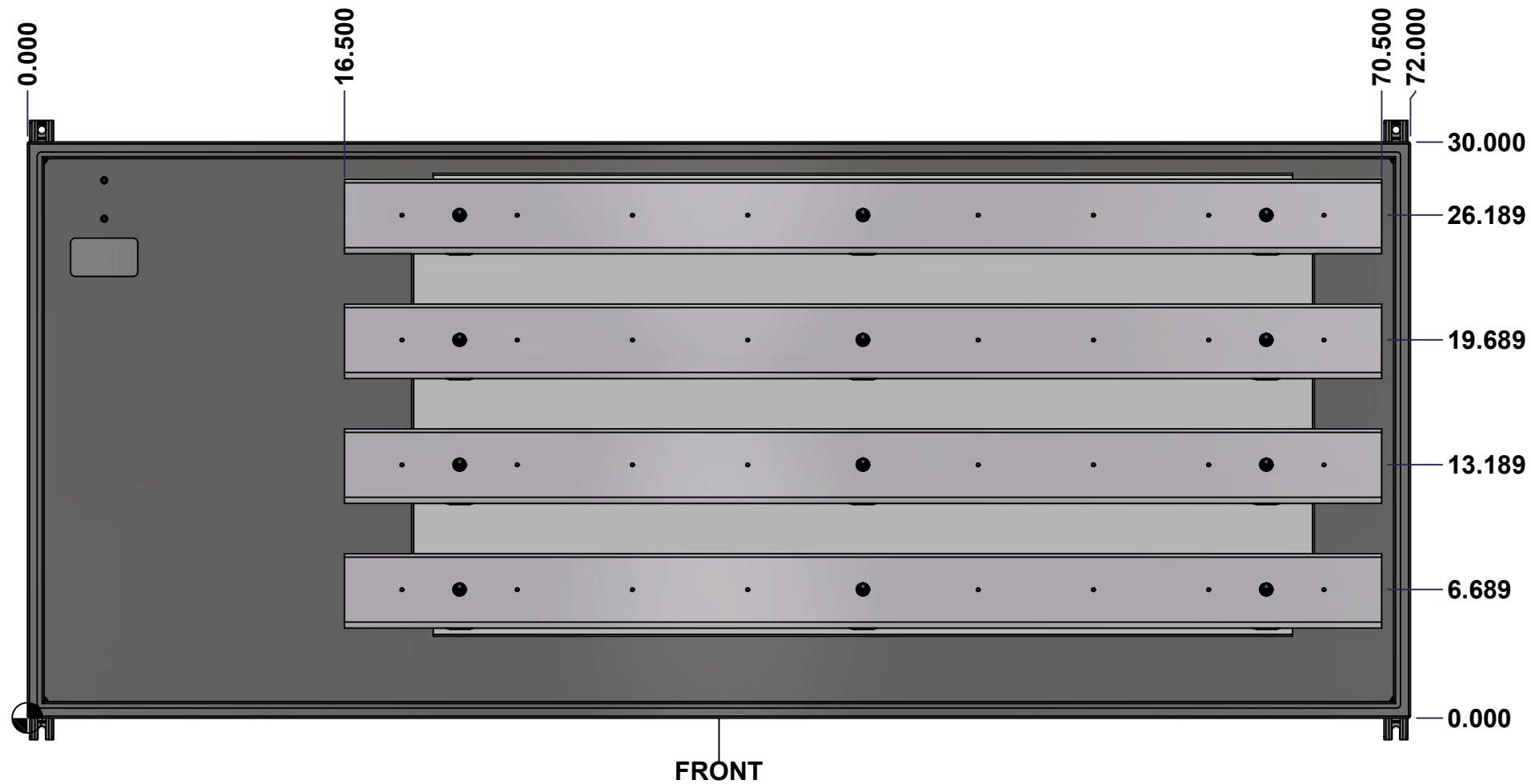

	Description		Status
	1412BTSS 1200A - 4Wires x 72" Assembly		(NULL)
Part Number		Rev.	2
Numéro Pièce		<b>0</b>	15
<b>1412BTSS061204DT</b>			

This drawing is confidential and must not be reproduced or used without the consent of EXM

Ce dessin est confidentiel et ne doit pas être reproduit ou utilisé sans le consentement de EXM

NOTE	
ITEM	DESCRIPTION
1	NEMA 4X Enclosure
2	C/W Standard ground studs on box and cover
3	W/O Standard door stiffener
4	C/W Special inner panel (Sold separately)
5	C/W Standard inner panel mounting studs

No.	Revisions	Date	By/Par

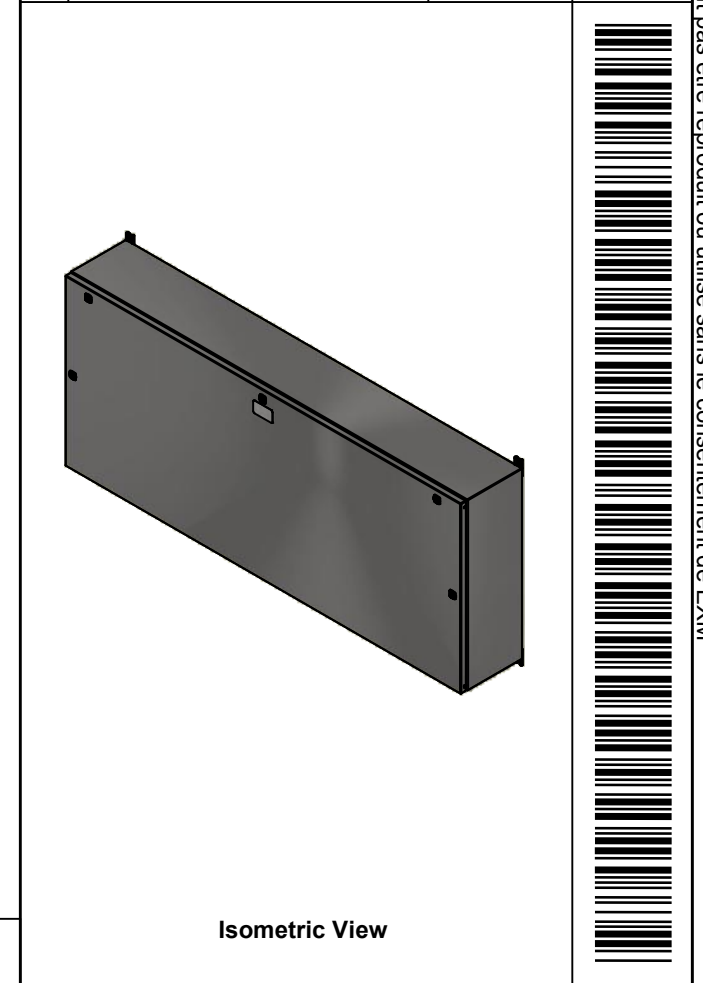

4	STK-Q-04051-07	8	M6 x 7mm Stainless Steel Hexagon Socket Head Machine Screw with Nyseal
1	885 ESMF2	0	885 ESMF2 Stainless Steel Mounting Feet Kit
1	1412BTSS061204DTBAR 4-P	0	Rounded Edge Aluminum Bar 1/2" x 4"
1	1412BTSS061204DTBAR 1-P	0	Rounded Edge Aluminum Bar 1/2" x 4"
1	1412BTSS061204DTBAR 2-P	0	Rounded Edge Aluminum Bar 1/2" x 4"
1	1412BTSS061204DTBAR 3-P	0	Rounded Edge Aluminum Bar 1/2" x 4"
1	1412BTSS061204DTIP1	0	1412BTSS 24.125" x 47" Inner Panel
12	STK-A-67400	0	Buss Bar Insulator Kit
1	STK-K-01800	5	5412 ES Accessory Kit
18	STK-Q-07310	2	Flange Lock Nut M8
6	STK-Q-07610	8	M8 Plastic Spacer 22.2mm
1	1412BTSS061204DTB	0	1412BTSS 30" x 72" x 10" Body
1	1412BTSS061204DTC	0	1412BTSS 30" x 72" Cover

PACKING		
ITEM	QTY	DESCRIPTION
Cardboard sleeve	2	Top and Bottom
Cardboard strip	2	Between back of enclosure and inner panel
Plastic bag	1	To protect cover surface and inside gasket
Cardboard corner	4	To reinforced for the plastic strap tightening
Plastic strap - Black	2	To Squeeze 2 cardboard sleeve together
Packaging label	3	White label with PN
Plastic strap- Green	2	To secure the enclosure to the wood pallet
Wood Pallet	1	2" deeper and 3" larger than enclosure size

Tél: (450) 979-4373  
Fax: (450) 979-4626  
[www.exmweb.com](http://www.exmweb.com)

Flatness  
Aplatissement  
Max 3.0mm

Projection

Customer Client	Date
Drawn By Dessiné Par BoxCad: BoxCad	Date 01-Nov-22
Material Matière 14 Ga Stainless Steel 304 (1.7mm)	
Color Couleur Unpainted	Finish Fini Brushed
Description 1412BTSS 1200A - 4Wires x 72" Assembly	Detail Rev.
Part Number Numéro Pièce <b>1412BTSS061204DT</b>	Rev. 0

Qty	Part Number	Rev	Description
Parts List			

This drawing is confidential and must not be reproduced or used without the consent of EXM

Ce dessin est confidentiel et ne doit pas être reproduit ou utilisé sans le consentement de EXM



TOP

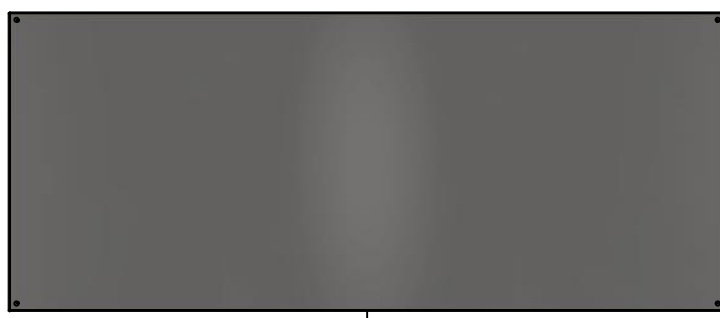

BACK

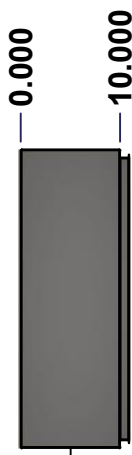

LEFT

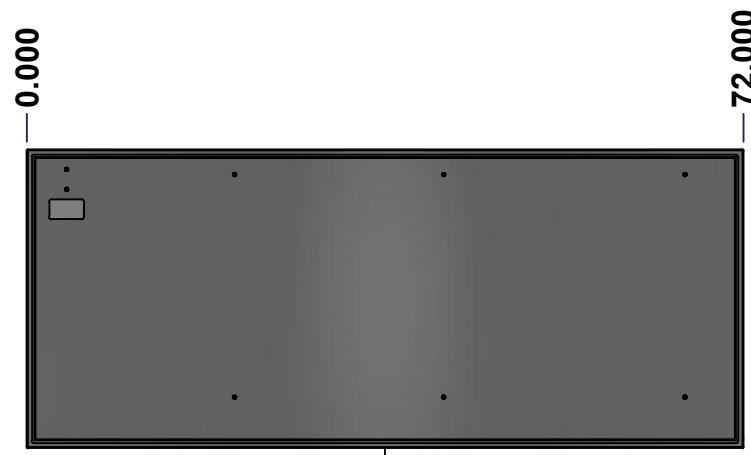

FRONT

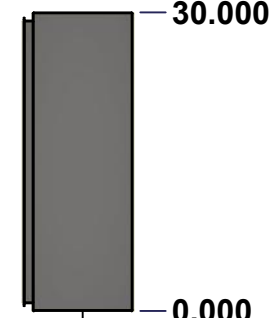

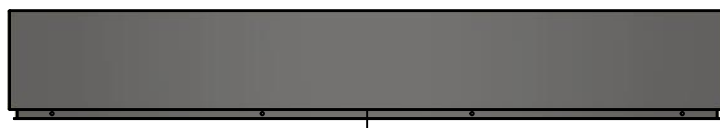

RIGHT

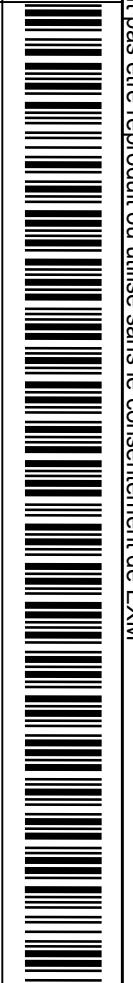
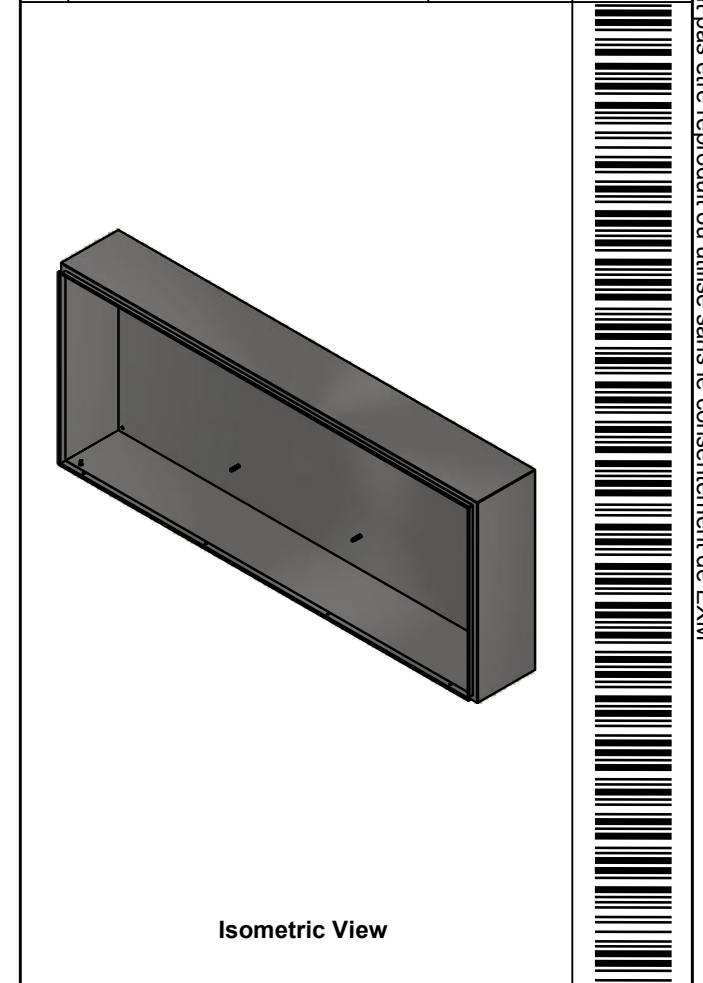

BOTTOM

No.	Revisions	Date	By/Par



 Tél: (450) 979-4373 Fax: (450) 979-4626 <a href="http://www.exmweb.com">www.exmweb.com</a>		Flatness Aplatissement	
		Max 3.0mm	
Customer Client		Date	
Drawn By Dessiné Par BoxCad: BoxCad		Date 01-Nov-22	
Material Matière 14 Ga Stainless Steel 304 (1.7mm)			
Color Couleur Unpainted		Finish Fini Brushed	
Description 1412BTSS 30" x 72" x 10" Body			Detail Rev.
Part Number Numéro Pièce <b>1412BTSS061204DTB</b>		Rev. <b>0</b>	4 15

SEE BILL OF MATERIAL ON LAST PAGE

This drawing is confidential and must not be reproduced or used without the consent of Eurobox

Ce dessin est confidentiel et ne doit pas être reproduit ou utilisé sans le consentement de Eurobox

**STANDARD FEATURES ARE NOT LISTED IN THIS HOLE TABLE**

**HOLE TABLE - BACK VIEW (CUSTOM FEATURE ONLY)**

CUT-OUT	XDIM	YDIM	DESCRIPTION
1	68.000	28.000	GND STUD M8 x 35mm (Inside)
2	68.000	26.000	GND STUD M8 x 35mm (Inside)
3	5.875	27.500	IP STUD M8 x 35mm (Inside)
4	51.125	27.500	IP STUD M8 x 35mm (Inside)
5	5.875	5.125	IP STUD M8 x 35mm (Inside)
6	51.125	5.125	IP STUD M8 x 35mm (Inside)
7	30.125	27.500	IP STUD M8 x 35mm (Inside)
8	30.125	5.125	IP STUD M8 x 35mm (Inside)

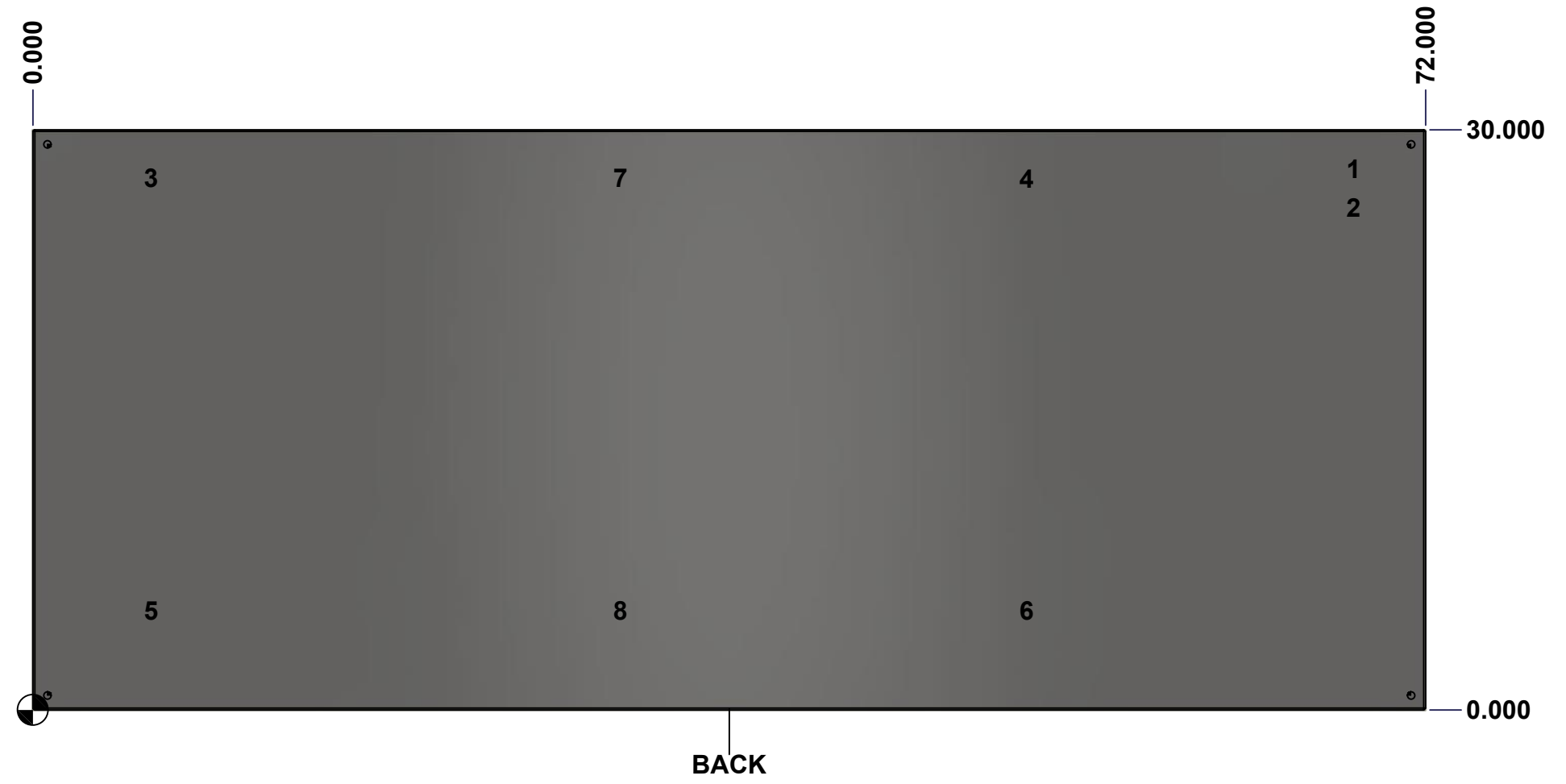



	Description	Status
	1412BTSS 30" x 72" x 10" Body	(NULL)
	Part Number Numéro Pièce	Rev.
	<b>1412BTSS061204DTB</b>	<b>0</b> / 5
		15

This drawing is confidential and must not be reproduced or used without the consent of EXM

Ce dessin est confidentiel et ne doit pas être reproduit ou utilisé sans le consentement de EXM

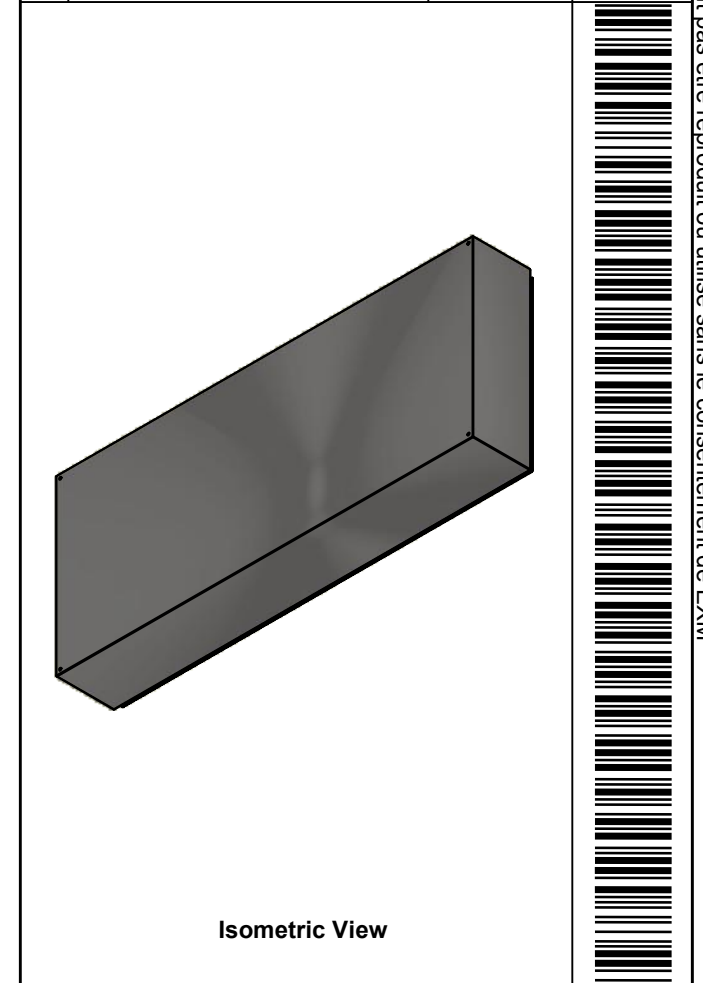
No.	Revisions	Date	By/Par

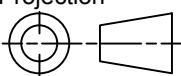

 Tél: (450) 979-4373 Fax: (450) 979-4626 <a href="http://www.exmweb.com">www.exmweb.com</a>		Flatness Aplatissement Max 3.0mm
Customer Client		Projection 
Drawn By / Dessiné Par: BoxCad: BoxCad		Date: 01-Nov-22
Material / Matière: 14 Ga Stainless Steel 304 (1.7mm)		
Color / Couleur: Unpainted	Finish / Fini: Brushed	
Description: 1412BTSS 30" x 72" x 10" Body		Detail Rev.
Part Number / Numéro Pièce: <b>1412BTSS061204DTB</b>		Rev. 6 <b>0</b>

Qty	Part Number	Rev	Description
8	STK-Q-16020	1	Stud M8 x 35mm Stainless Steel
1	STK-Q-16095	0	M6 x 16mm Stainless Steel Ground Stud
1	STK-S-00100	0	3.5" x 2" Silver Milar Flexcon Sticker
1	1412BTSS061204DTB-P	0	1412BTSS 30" x 72" x 10" Body Part
Parts List			

This drawing is confidential and must not be reproduced or used without the consent of Eurobex

Ce dessin est confidentiel et ne doit pas être reproduit ou utilisé sans le consentement de Eurobex

**STANDARD FEATURES ARE NOT LISTED IN THIS HOLE TABLE**

**HOLE TABLE - FRONT VIEW (CUSTOM FEATURE ONLY)**

CUT-OUT	XDIM	YDIM	DESCRIPTION
1	51.000	2.000	RND Ø0.201 THREAD 1/4-20 UNC
2	45.000	2.000	RND Ø0.201 THREAD 1/4-20 UNC
3	39.000	2.000	RND Ø0.201 THREAD 1/4-20 UNC
4	33.000	2.000	RND Ø0.201 THREAD 1/4-20 UNC
5	21.000	2.000	RND Ø0.201 THREAD 1/4-20 UNC
6	15.000	2.000	RND Ø0.201 THREAD 1/4-20 UNC
7	9.000	2.000	RND Ø0.201 THREAD 1/4-20 UNC
8	3.000	2.000	RND Ø0.201 THREAD 1/4-20 UNC

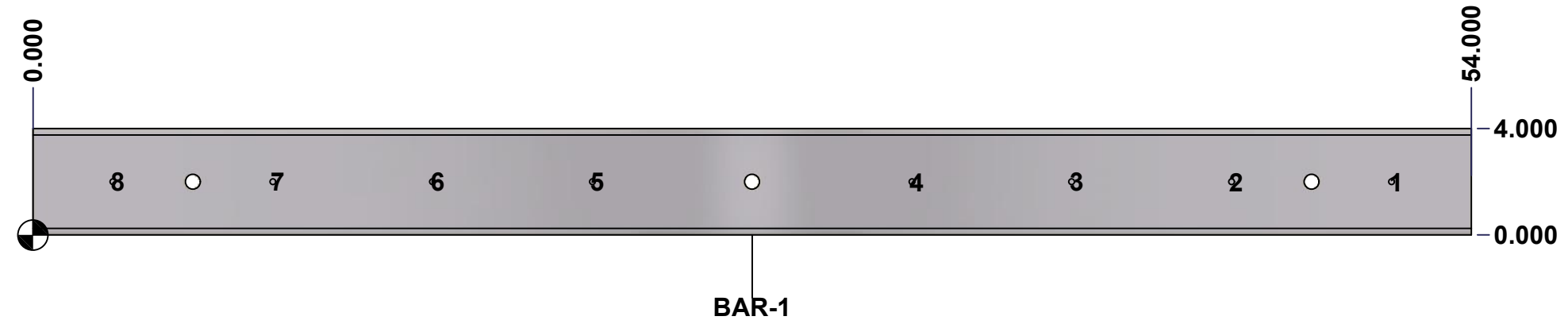

	Description	Status
	Rounded Edge Aluminum Bar 1/2" x 4"	(NULL)
	Part Number Numéro Pièce	Rev.
	<b>1412BTSS061204DTBAR1-P</b>	7
	<b>0</b>	15

This drawing is confidential and must not be reproduced or used without the consent of Eurobex

Ce dessin est confidentiel et ne doit pas être reproduit ou utilisé sans le consentement de Eurobex

STANDARD FEATURES ARE NOT LISTED IN THIS HOLE TABLE			
HOLE TABLE - FRONT VIEW (CUSTOM FEATURE ONLY)			
CUT-OUT	XDIM	YDIM	DESCRIPTION
1	51.000	2.000	RND Ø0.201 THREAD 1/4-20 UNC
2	45.000	2.000	RND Ø0.201 THREAD 1/4-20 UNC
3	39.000	2.000	RND Ø0.201 THREAD 1/4-20 UNC
4	33.000	2.000	RND Ø0.201 THREAD 1/4-20 UNC
5	21.000	2.000	RND Ø0.201 THREAD 1/4-20 UNC
6	15.000	2.000	RND Ø0.201 THREAD 1/4-20 UNC
7	9.000	2.000	RND Ø0.201 THREAD 1/4-20 UNC
8	3.000	2.000	RND Ø0.201 THREAD 1/4-20 UNC

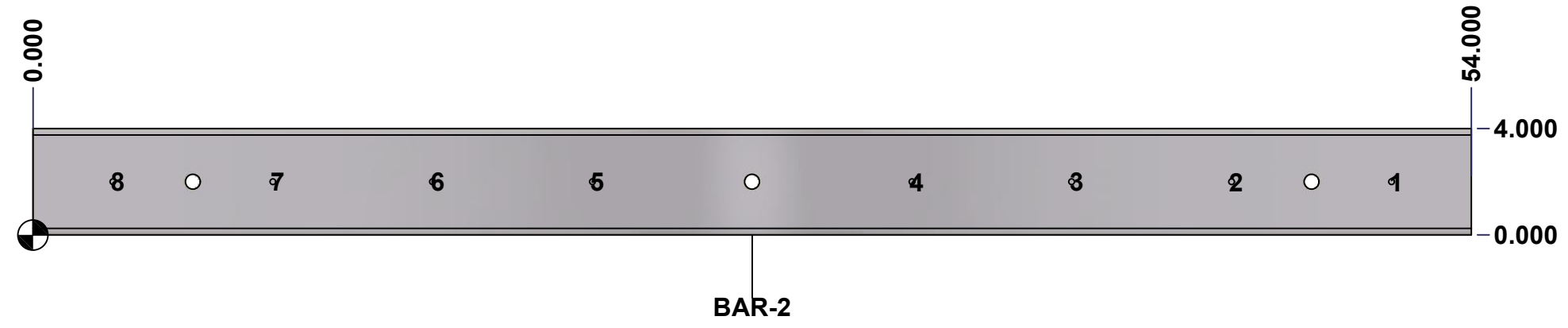

	Description	Status
	Rounded Edge Aluminum Bar 1/2" x 4"	(NULL)
	Part Number Numéro Pièce	Rev.
	<b>1412BTSS061204DTBAR2-P</b>	8
		<b>0</b>
		15



This drawing is confidential and must not be reproduced or used without the consent of Eurobex

Ce dessin est confidentiel et ne doit pas être reproduit ou utilisé sans le consentement de Eurobex

**STANDARD FEATURES ARE NOT LISTED IN THIS HOLE TABLE**

**HOLE TABLE - FRONT VIEW (CUSTOM FEATURE ONLY)**

CUT-OUT	XDIM	YDIM	DESCRIPTION
1	51.000	2.000	RND Ø0.201 THREAD 1/4-20 UNC
2	45.000	2.000	RND Ø0.201 THREAD 1/4-20 UNC
3	39.000	2.000	RND Ø0.201 THREAD 1/4-20 UNC
4	33.000	2.000	RND Ø0.201 THREAD 1/4-20 UNC
5	21.000	2.000	RND Ø0.201 THREAD 1/4-20 UNC
6	15.000	2.000	RND Ø0.201 THREAD 1/4-20 UNC
7	9.000	2.000	RND Ø0.201 THREAD 1/4-20 UNC
8	3.000	2.000	RND Ø0.201 THREAD 1/4-20 UNC

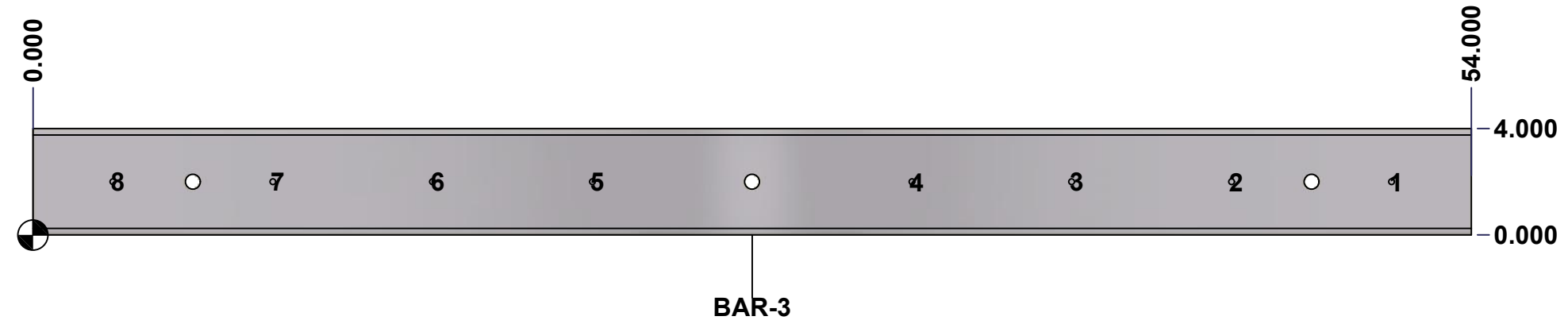

	Description	Status
	Rounded Edge Aluminum Bar 1/2" x 4"	(NULL)
	Part Number Numéro Pièce	Rev.
	<b>1412BTSS061204DTBAR3-P</b>	9
	<b>0</b>	15

This drawing is confidential and must not be reproduced or used without the consent of Eurobox

Ce dessin est confidentiel et ne doit pas être reproduit ou utilisé sans le consentement de Eurobox

**STANDARD FEATURES ARE NOT LISTED IN THIS HOLE TABLE**

**HOLE TABLE - FRONT VIEW (CUSTOM FEATURE ONLY)**

CUT-OUT	XDIM	YDIM	DESCRIPTION
1	51.000	2.000	RND Ø0.201 THREAD 1/4-20 UNC
2	45.000	2.000	RND Ø0.201 THREAD 1/4-20 UNC
3	39.000	2.000	RND Ø0.201 THREAD 1/4-20 UNC
4	33.000	2.000	RND Ø0.201 THREAD 1/4-20 UNC
5	21.000	2.000	RND Ø0.201 THREAD 1/4-20 UNC
6	15.000	2.000	RND Ø0.201 THREAD 1/4-20 UNC
7	9.000	2.000	RND Ø0.201 THREAD 1/4-20 UNC
8	3.000	2.000	RND Ø0.201 THREAD 1/4-20 UNC

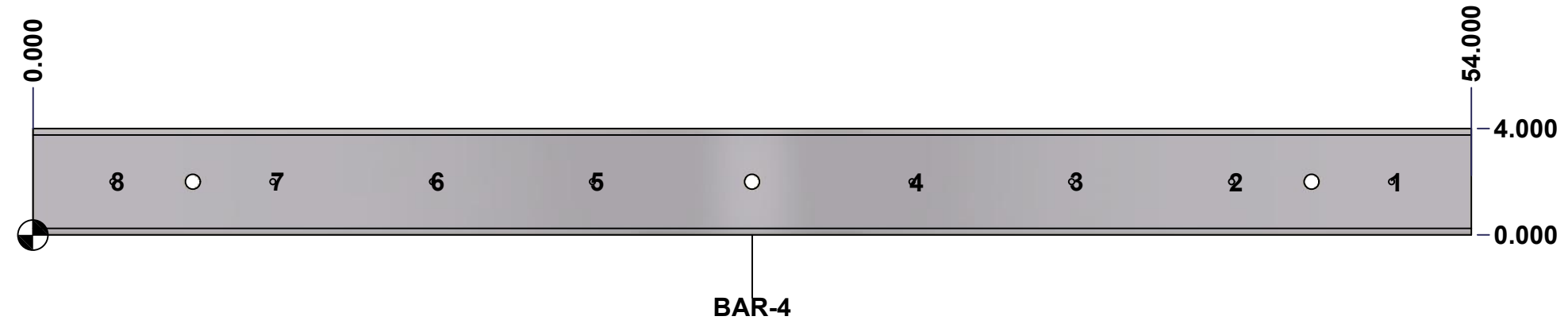

	Description	Status
	Rounded Edge Aluminum Bar 1/2" x 4"	(NULL)
	Part Number Numéro Pièce	Rev.
	<b>1412BTSS061204DTBAR4-P</b>	<b>0</b>
		10
		15

This drawing is confidential and must not be reproduced or used without the consent of EXM

Ce dessin est confidentiel et ne doit pas être reproduit ou utilisé sans le consentement de EXM



TOP

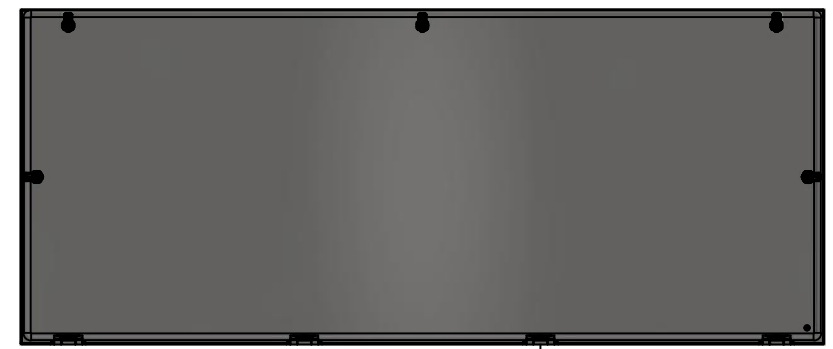

BACK

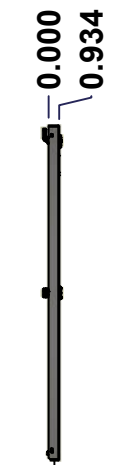

LEFT

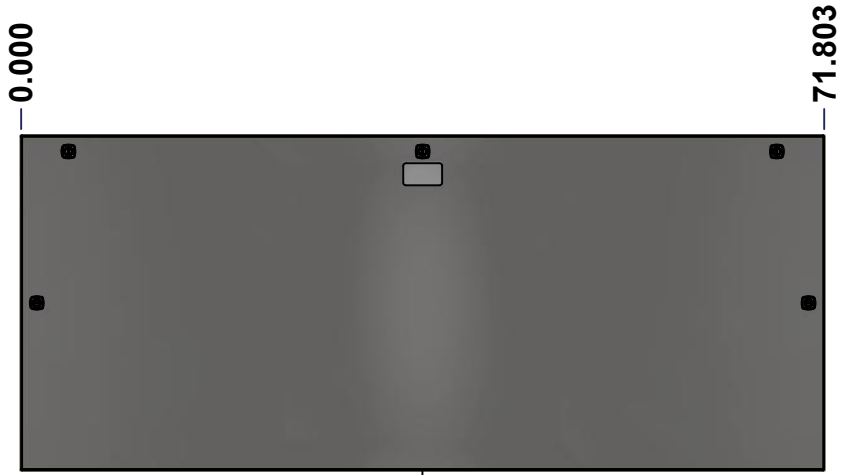

FRONT

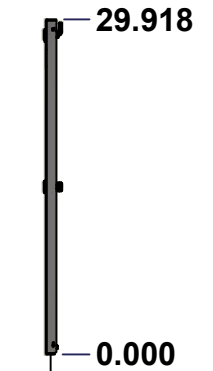

RIGHT



BOTTOM

No.	Revisions	Date	By/Par



Isometric View

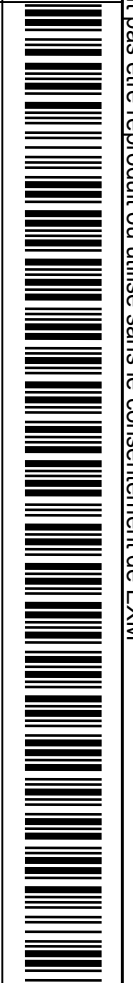

Tél: (450) 979-4373  
 Fax: (450) 979-4626  
[www.exmweb.com](http://www.exmweb.com)

Flatness  
Aplatissement  
Max 3.0mm  
Projection

Customer Client	Date
Drawn By / Dessiné Par: BoxCad: BoxCad	Date: 01-Nov-22
Material / Matière: 14 Ga Stainless Steel 304 (1.7mm)	

Color / Couleur: Unpainted	Finish / Fini: Brushed
----------------------------	------------------------

Description: 1412BTSS 30" x 72" Cover	Detail Rev.
---------------------------------------	-------------

Part Number / Numéro Pièce: 1412BTSS061204DTC	Rev. 0	11
-----------------------------------------------	--------	----

SEE BILL OF MATERIAL ON LAST PAGE

This drawing is confidential and must not be reproduced or used without the consent of Eurobox

Ce dessin est confidentiel et ne doit pas être reproduit ou utilisé sans le consentement de Eurobox

**STANDARD FEATURES ARE NOT LISTED IN THIS HOLE TABLE**

**HOLE TABLE - FRONT VIEW (CUSTOM FEATURE ONLY)**

CUT-OUT	XDIM	YDIM	DESCRIPTION
1	1.500	1.486	GND STUD M6 x 16mm (Inside)
2	70.379	14.959	LOCK 880 SCQ4-SLSS6 @ 0.0°
3	1.424	14.959	LOCK 880 SCQ4-SLSS6 @ 180.0°
4	67.553	28.494	LOCK 880 SCQ4-SLSS6 @ 90.0°
5	35.902	28.494	LOCK 880 SCQ4-SLSS6 @ 90.0°
6	4.250	28.494	LOCK 880 SCQ4-SLSS6 @ 90.0°

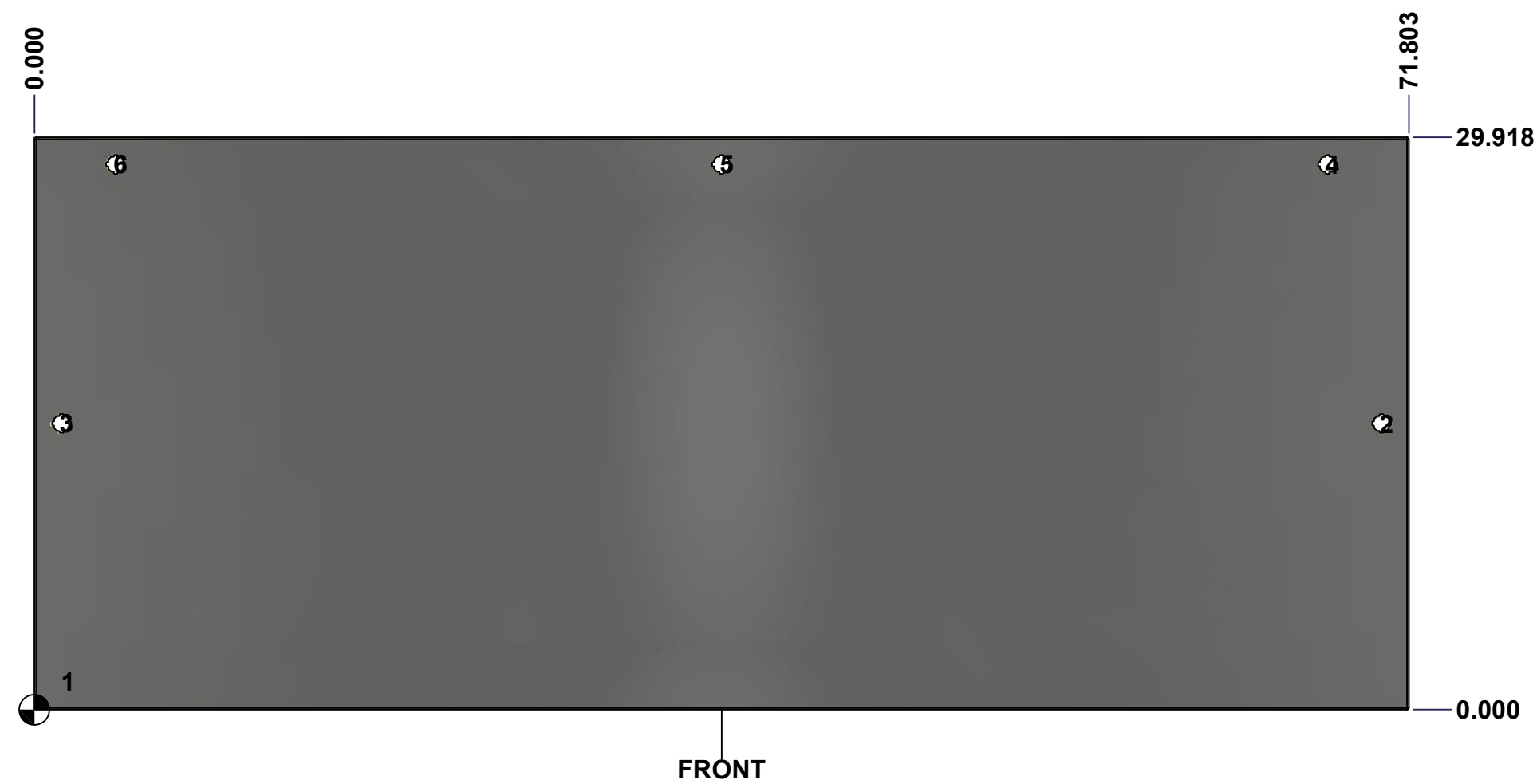

	Description	Status	
	1412BTSS 30" x 72" Cover	(NULL)	
	Part Number Numéro Pièce	Rev.	12
	<b>1412BTSS061204DTC</b>	<b>0</b>	15

This drawing is confidential and must not be reproduced or used without the consent of EXM

Ce dessin est confidentiel et ne doit pas être reproduit ou utilisé sans le consentement de EXM

No.	Revisions	Date	By/Par



Isometric View

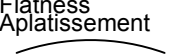
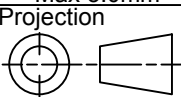

 Tél: (450) 979-4373 Fax: (450) 979-4626 <a href="http://www.exmweb.com">www.exmweb.com</a>		Flatness Aplatissement  Max 3.0mm
Customer Client		Projection 
Drawn By / Dessiné Par: BoxCad: BoxCad		Date: 01-Nov-22
Material / Matière: 14 Ga Stainless Steel 304 (1.7mm)		
Color / Couleur: Unpainted	Finish / Fini: Brushed	
Description: 1412BTSS 30" x 72" Cover		Detail Rev.
Part Number / Numéro Pièce: <b>1412BTSS061204DTC</b>		Rev. 13 / 15

Qty	Part Name	Rev	Description
1	1412BTSS061204DTG	0	1412BTSS 30" x 72" Cover Gasket
4	STK-K-09850	6	5412 ESS Hinge with 2 Captive Hinge Pins
1	STK-Q-16095	0	M6 x 16mm Stainless Steel Ground Stud
1	STK-S-00100	0	3.5" x 2" Silver Milar Flexcon Sticker
1	1412BTSS061204DTC-P	0	1412BTSS 30" x 72" Cover Part
5	880 SCQ4-SLSS6	7	5412 ESS 1/4 Turn Lock
Parts List			

This drawing is confidential and must not be reproduced or used without the consent of EXM

Ce dessin est confidentiel et ne doit pas être reproduit ou utilisé sans le consentement de EXM



TOP

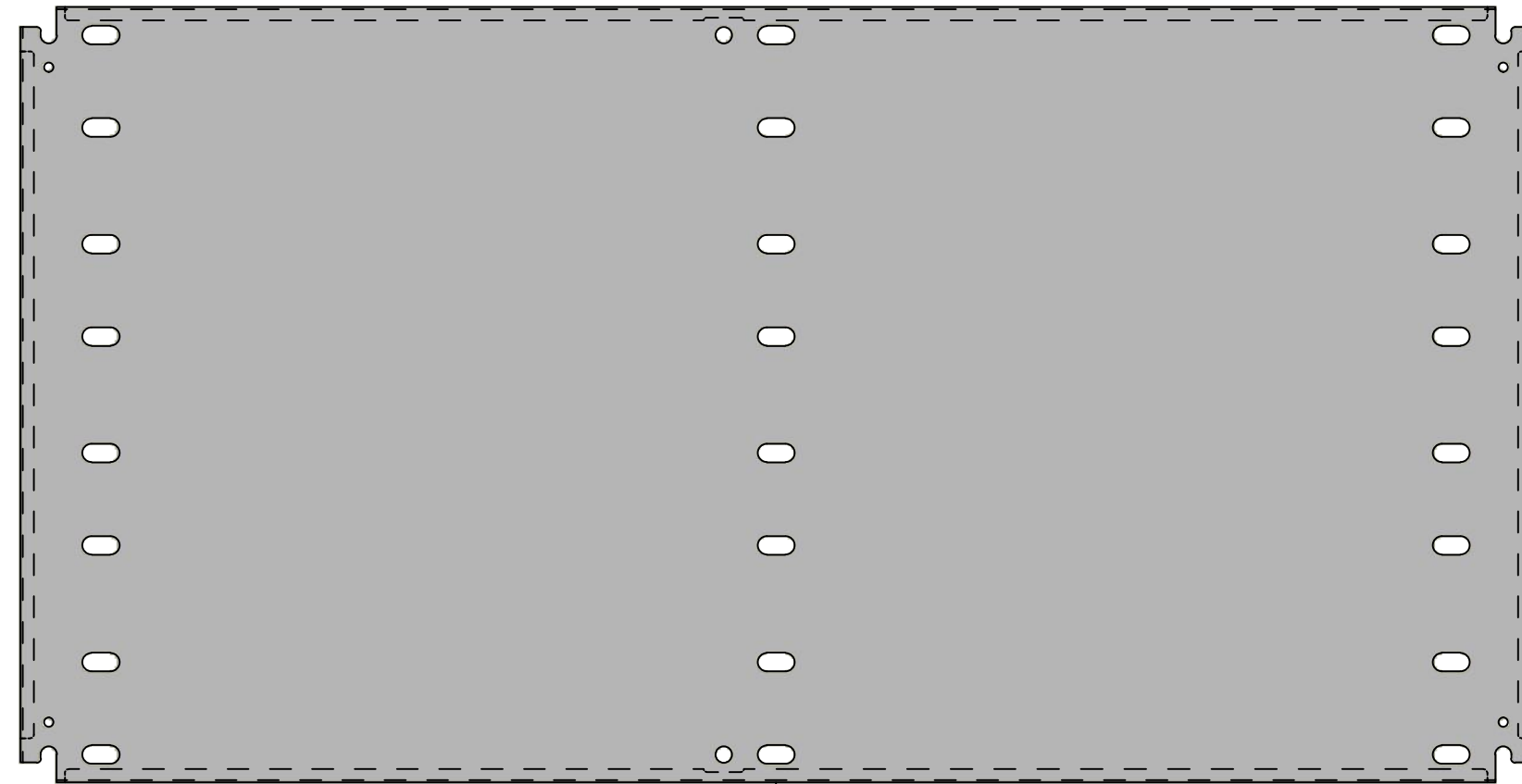

FRONT

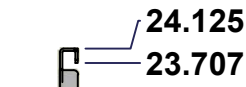

RIGHT

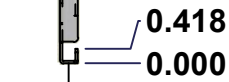

No.	Revisions	Date	By/Par

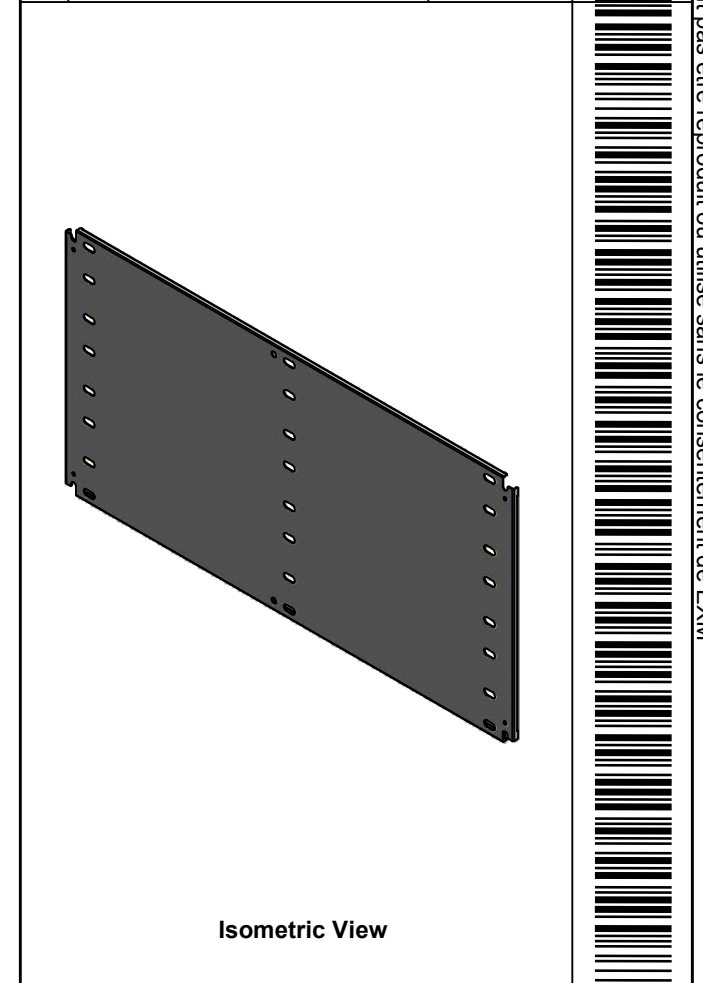

Isometric View

<p>Tél: (450) 979-4373 Fax: (450) 979-4626 <a href="http://www.exmweb.com">www.exmweb.com</a></p>	Flatness Aplatissement Max 3.0mm
	Projection 
Customer Client	Date
Drawn By Dessiné Par BoxCad: BoxCad	Date 01-Nov-22
Material Matière 14 Ga Cold Rolled A1008 CS Type B (1.7mm)	
Color Couleur White RAL9003	Finish Fini Smooth
Description 1412BTSS 24.125" x 47" Inner Panel	
Detail Rev.	
Part Number Numéro Pièce <b>1412BTSS061204DTIP1</b>	Rev. <b>0</b>
	14 / 15

SEE BILL OF MATERIAL ON LAST PAGE

This drawing is confidential and must not be reproduced or used without the consent of EXM

Ce dessin est confidentiel et ne doit pas être reproduit ou utilisé sans le consentement de EXM

No.	Revisions	Date	By/Par

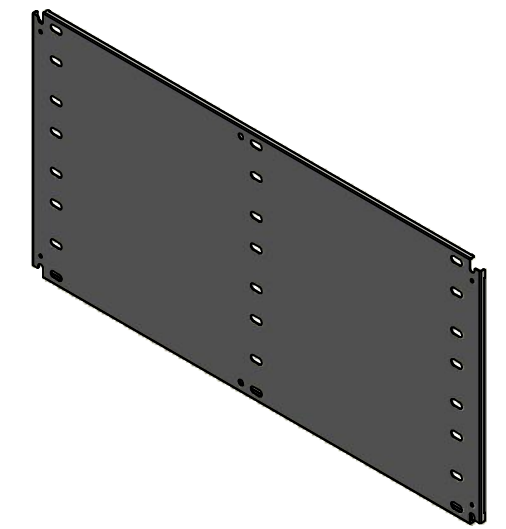

Isometric View

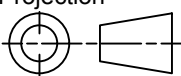

 Tél: (450) 979-4373 Fax: (450) 979-4626 <a href="http://www.exmweb.com">www.exmweb.com</a>		Flatness Aplatissement Max 3.0mm Projection 
Customer Client	Date	
Drawn By Dessiné Par	BoxCad: BoxCad	Date 01-Nov-22
Material Matière	14 Ga Cold Rolled A1008 CS Type B (1.7mm)	
Color Couleur	White RAL9003	Finish Fini Smooth
Description		Detail Rev.
1412BTSS 24.125" x 47" Inner Panel		
Part Number Numéro Pièce	Rev.	15
<b>1412BTSS061204DTIP1</b>	<b>0</b>	15

Qty	Part Number	Rev	Description
1	STK-P-02401S	0	Powder Paint (White / Smooth)
1	1412BTSS061204DTIP1-P	0	1412BTSS 24.125" x 72" Inner Panel Part
Parts List			