

This drawing is confidential and must not be reproduced or used without the consent of EXM

Ce dessin est confidentiel et ne doit pas être reproduit ou utilisé sans le consentement de EXM

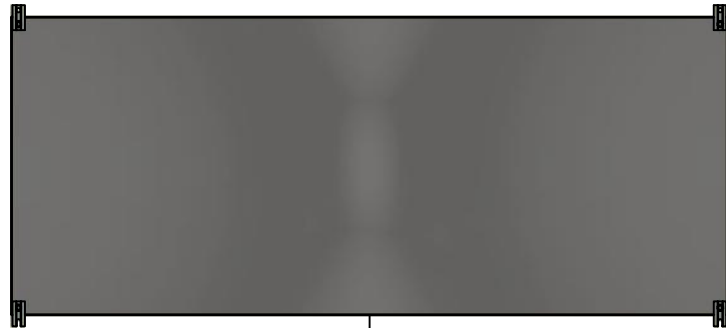

TOP



BACK

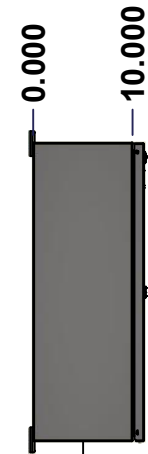

LEFT

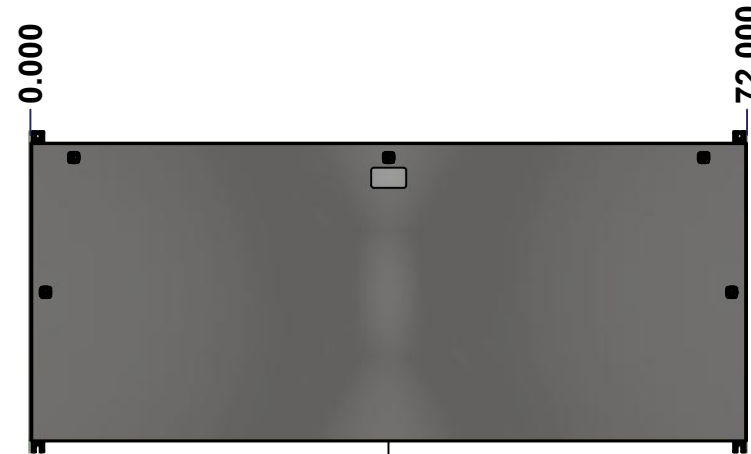

FRONT

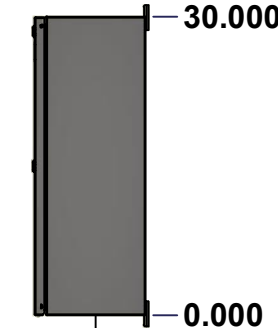

RIGHT



BOTTOM

No.	Revisions	Date	By/Par

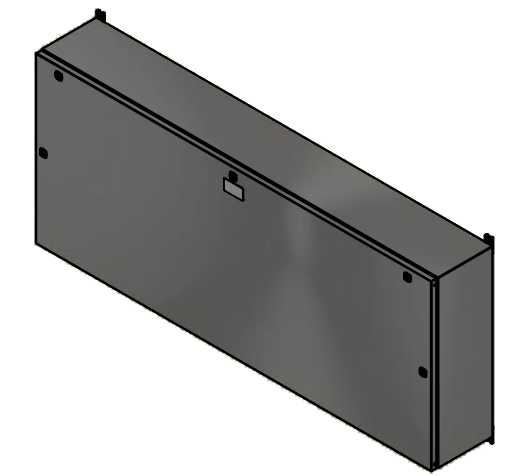

Isometric View



Tél: (450) 979-4373
 Fax: (450) 979-4626
www.exmweb.com

Flatness
Aplatissement
Max 3.0mm
Projection

Customer Client	Date
Drawn By Dessiné Par BoxCad: BoxCad	Date 02-Nov-22
Material Matière 14 Ga Stainless Steel 304 (1.7mm)	
Color Couleur Unpainted	Finish Fini Brushed
Description 1412BTSS 2500A - 3Wires x 72" Assembly	Detail Rev.
Part Number Numéro Pièce 1412BTSS062503DT	Rev. 0

SEE BILL OF MATERIAL ON LAST PAGE

This drawing is confidential and must not be reproduced or used without the consent of Eurobox

STANDARD FEATURES ARE NOT LISTED IN THIS HOLE TABLE

Ce dessin est confidentiel et ne doit pas être reproduit ou utilisé sans le consentement de Eurobox

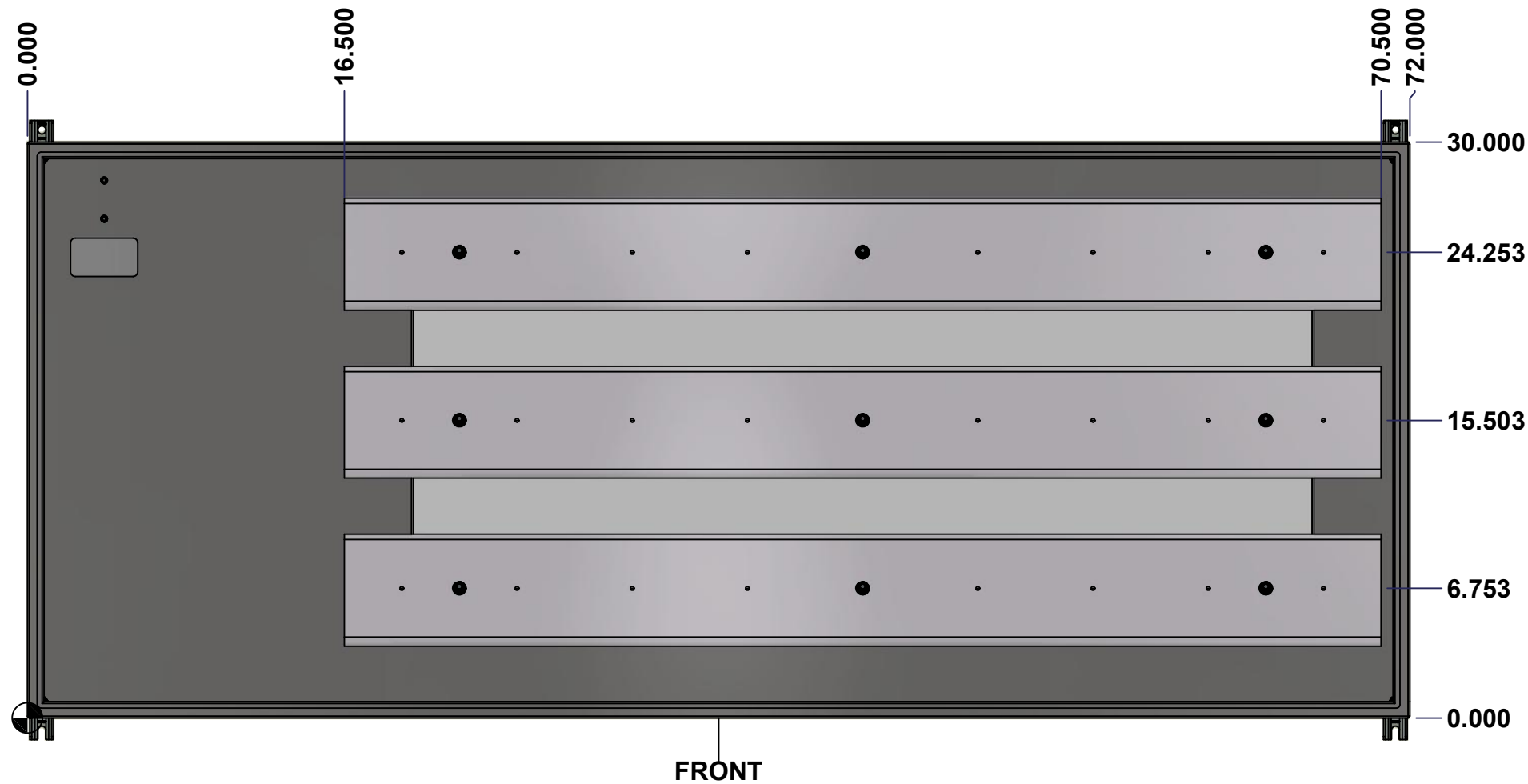

	Description 1412BTSS 2500A - 3Wires x 72" Assembly	Status (NULL)
	Part Number Numéro Pièce 1412BTSS062503DT	Rev. 2 0

This drawing is confidential and must not be reproduced or used without the consent of EXM

Ce dessin est confidentiel et ne doit pas être reproduit ou utilisé sans le consentement de EXM

NOTE	
ITEM	DESCRIPTION
1	NEMA 4X Enclosure
2	C/W Standard ground studs on box and cover
3	W/O Standard door stiffener
4	C/W Special inner panel (Sold separately)
5	C/W Standard inner panel mounting studs

No.	Revisions	Date	By/Par

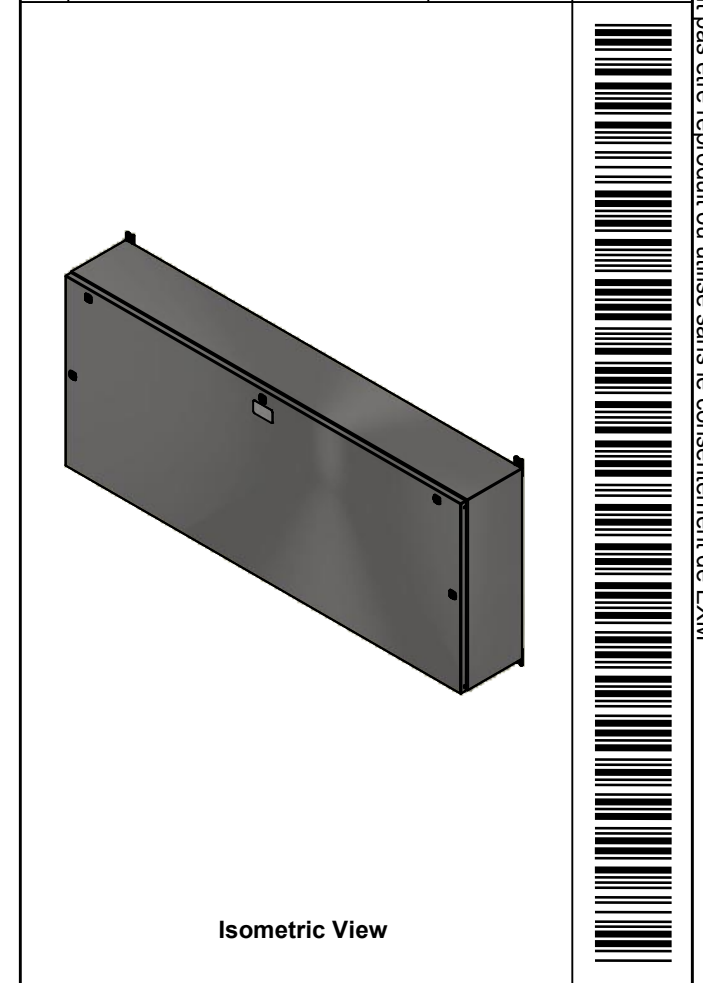

PACKING		
ITEM	QTY	DESCRIPTION
Cardboard sleeve	2	Top and Bottom
Cardboard strip	2	Between back of enclosure and inner panel
Plastic bag	1	To protect cover surface and inside gasket
Cardboard corner	4	To reinforced for the plastic strap tightening
Plastic strap - Black	2	To Squeeze 2 cardboard sleeve together
Packaging label	3	White label with PN
Plastic strap- Green	2	To secure the enclosure to the wood pallet
Wood Pallet	1	2" deeper and 3" larger than enclosure size

4	STK-Q-04051-07	8	M6 x 7mm Stainless Steel Hexagon Socket Head Machine Screw with Nyseal
1	885 ESMF2	0	885 ESMF2 Stainless Steel Mounting Feet Kit
1	1412BTSS062503DTBAR 1-P	0	Rounded Edge Aluminum Bar 3/4" x 6"
1	1412BTSS062503DTBAR 2-P	0	Rounded Edge Aluminum Bar 3/4" x 6"
1	1412BTSS062503DTBAR 3-P	0	Rounded Edge Aluminum Bar 3/4" x 6"
1	1412BTSS062503DTIP1	0	1412BTSS 22.125" x 47" Inner Panel
9	STK-A-67400	0	Buss Bar Insulator Kit
1	STK-K-01800	5	5412 ES Accessory Kit
15	STK-Q-07310	2	Flange Lock Nut M8
6	STK-Q-07610	8	M8 Plastic Spacer 22.2mm
1	1412BTSS062503DTB	0	1412BTSS 30" x 72" x 10" Body
1	1412BTSS062503DTC	0	1412BTSS 30" x 72" Cover
Qty	Part Number	Rev	Description
Parts List			

Tél: (450) 979-4373
Fax: (450) 979-4626
www.exmweb.com

Flatness
Aplatissement
Max 3.0mm

Projection

Customer Client	Date
Drawn By Dessiné Par	Date 02-Nov-22
Material Matière	14 Ga Stainless Steel 304 (1.7mm)
Color Couleur	Unpainted Finish Finis
Description	Detail Rev.
1412BTSS 2500A - 3Wires x 72" Assembly	
Part Number Numéro Pièce	Rev. 3
1412BTSS062503DT	0

This drawing is confidential and must not be reproduced or used without the consent of EXM

Ce dessin est confidentiel et ne doit pas être reproduit ou utilisé sans le consentement de EXM



TOP

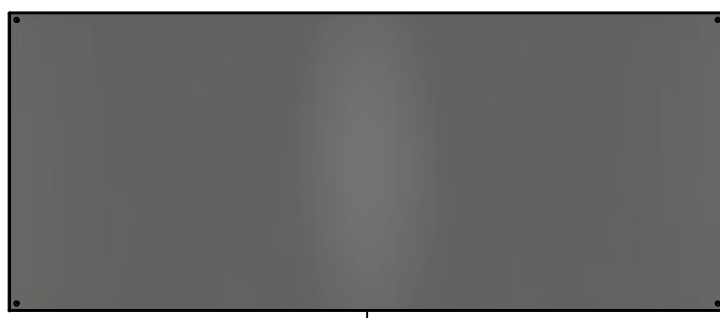

BACK

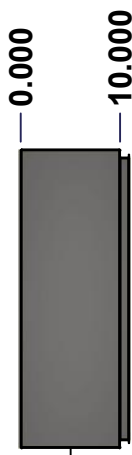

LEFT

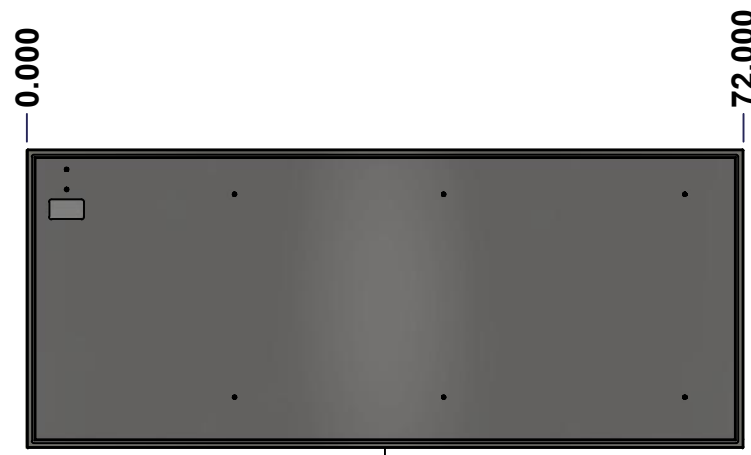

FRONT

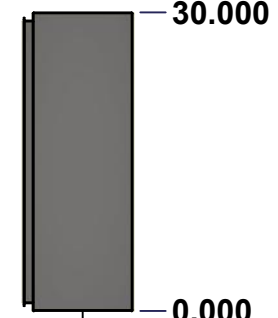

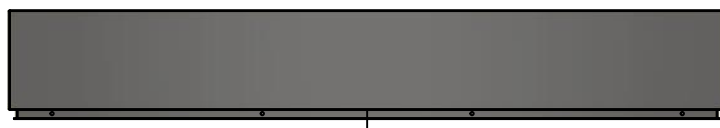

RIGHT

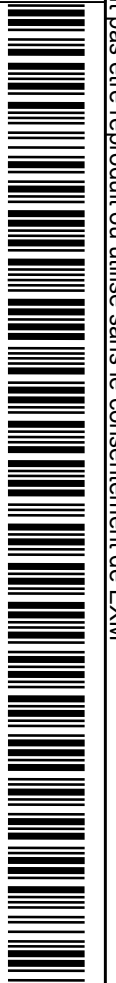
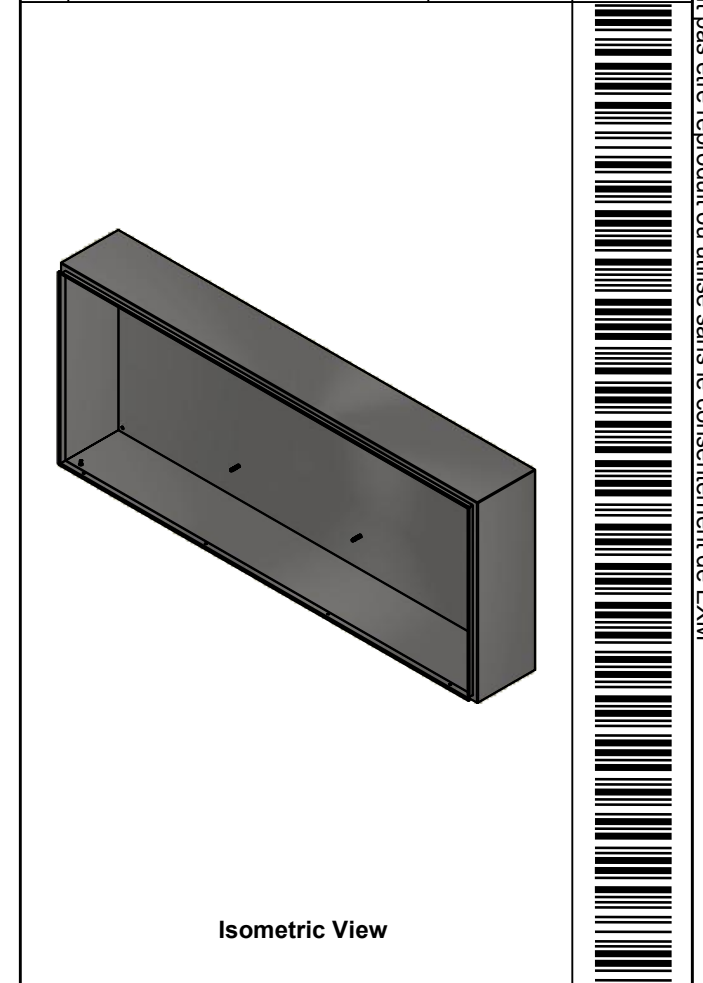

BOTTOM

No.	Revisions	Date	By/Par

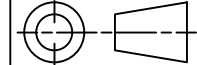

 Tél: (450) 979-4373 Fax: (450) 979-4626 www.exmweb.com		Flatness Aplatissement Max 3.0mm Projection 
Customer Client	Date	
Drawn By Dessiné Par	BoxCad: BoxCad	Date 02-Nov-22
Material Matière	14 Ga Stainless Steel 304 (1.7mm)	
Color Couleur	Unpainted	Finish Fini Brushed
Description	Detail Rev.	
1412BTSS 30" x 72" x 10" Body		
Part Number Numéro Pièce	Rev.	4
1412BTSS062503DTB	0	14

SEE BILL OF MATERIAL ON LAST PAGE

This drawing is confidential and must not be reproduced or used without the consent of Eurobox

Ce dessin est confidentiel et ne doit pas être reproduit ou utilisé sans le consentement de Eurobox

STANDARD FEATURES ARE NOT LISTED IN THIS HOLE TABLE

HOLE TABLE - BACK VIEW (CUSTOM FEATURE ONLY)

CUT-OUT	XDIM	YDIM	DESCRIPTION
1	68.000	28.000	GND STUD M8 x 35mm (Inside)
2	68.000	26.000	GND STUD M8 x 35mm (Inside)
3	5.875	25.500	IP STUD M8 x 35mm (Inside)
4	51.125	25.500	IP STUD M8 x 35mm (Inside)
5	5.875	5.125	IP STUD M8 x 35mm (Inside)
6	51.125	5.125	IP STUD M8 x 35mm (Inside)
7	30.125	25.500	IP STUD M8 x 35mm (Inside)
8	30.125	5.125	IP STUD M8 x 35mm (Inside)

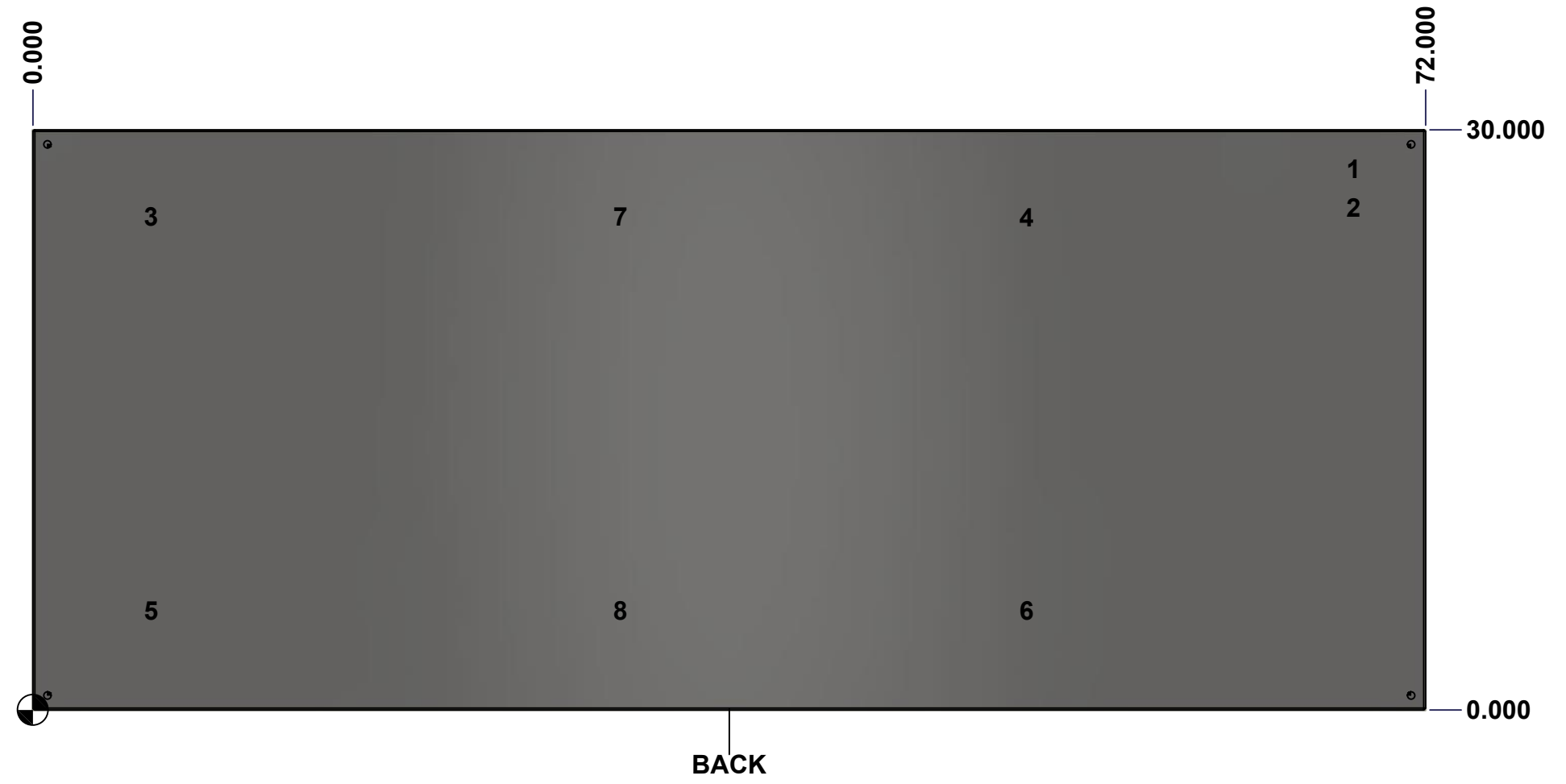



	Description	Status
	1412BTSS 30" x 72" x 10" Body	(NULL)
	Part Number Numéro Pièce	Rev.
	1412BTSS062503DTB	0 / 5
		14

This drawing is confidential and must not be reproduced or used without the consent of EXM

Ce dessin est confidentiel et ne doit pas être reproduit ou utilisé sans le consentement de EXM

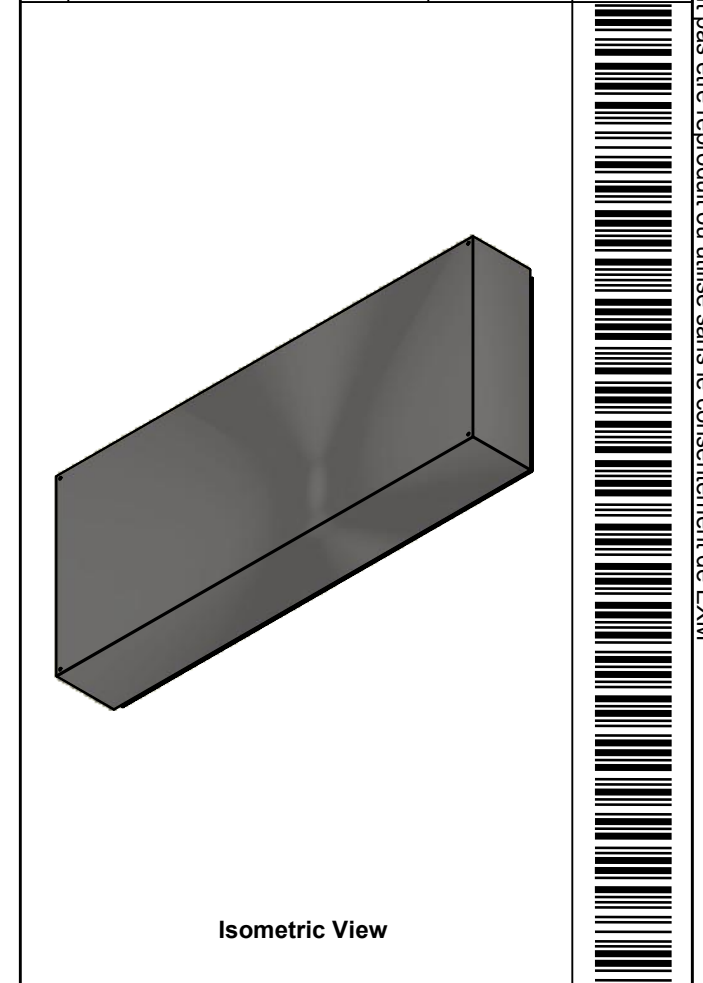
No.	Revisions	Date	By/Par

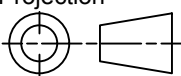

 Tél: (450) 979-4373 Fax: (450) 979-4626 www.exmweb.com		Flatness Aplatissement Max 3.0mm Projection 
Customer Client	Date	
Drawn By Dessiné Par	BoxCad: BoxCad	Date 02-Nov-22
Material Matière	14 Ga Stainless Steel 304 (1.7mm)	
Color Couleur	Unpainted	Finish Fini Brushed
Description		Detail Rev.
1412BTSS 30" x 72" x 10" Body		
Part Number Numéro Pièce	Rev.	6
1412BTSS062503DTB	0	14

Qty	Part Number	Rev	Description
8	STK-Q-16020	1	Stud M8 x 35mm Stainless Steel
1	STK-Q-16095	0	M6 x 16mm Stainless Steel Ground Stud
1	STK-S-00100	0	3.5" x 2" Silver Milar Flexcon Sticker
1	1412BTSS062503DTB-P	0	1412BTSS 30" x 72" x 10" Body Part
Parts List			

This drawing is confidential and must not be reproduced or used without the consent of Eurobox

Ce dessin est confidentiel et ne doit pas être reproduit ou utilisé sans le consentement de Eurobox

STANDARD FEATURES ARE NOT LISTED IN THIS HOLE TABLE

HOLE TABLE - FRONT VIEW (CUSTOM FEATURE ONLY)

CUT-OUT	XDIM	YDIM	DESCRIPTION
1	51.000	3.000	RND Ø0.201 THREAD 1/4-20 UNC
2	45.000	3.000	RND Ø0.201 THREAD 1/4-20 UNC
3	39.000	3.000	RND Ø0.201 THREAD 1/4-20 UNC
4	33.000	3.000	RND Ø0.201 THREAD 1/4-20 UNC
5	21.000	3.000	RND Ø0.201 THREAD 1/4-20 UNC
6	15.000	3.000	RND Ø0.201 THREAD 1/4-20 UNC
7	9.000	3.000	RND Ø0.201 THREAD 1/4-20 UNC
8	3.000	3.000	RND Ø0.201 THREAD 1/4-20 UNC

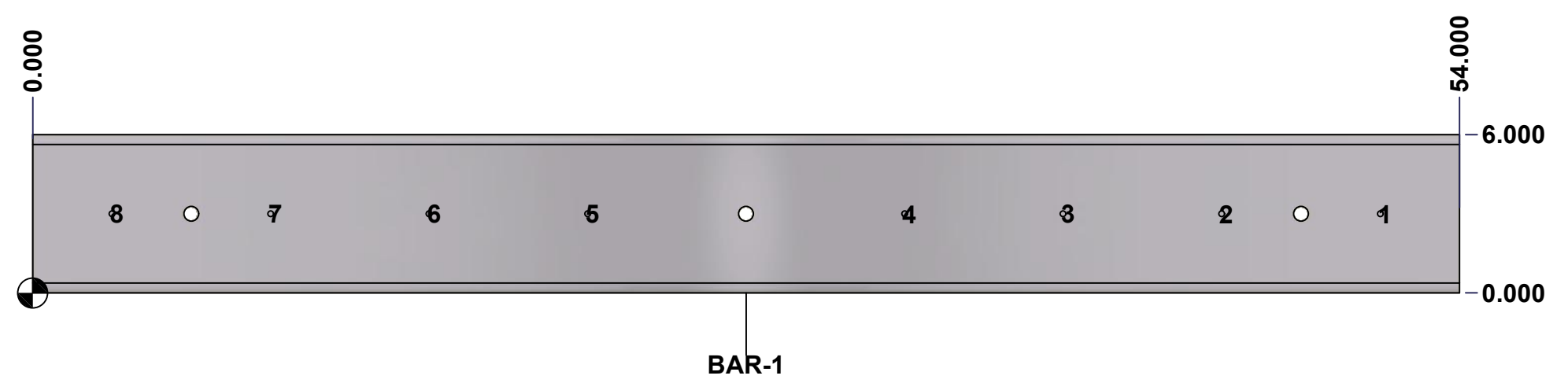

	Description	Status
	Rounded Edge Aluminum Bar 3/4" x 6"	(NULL)
	Part Number Numéro Pièce	Rev.
1412BTSS062503DTBAR1-P	0	7
		14

This drawing is confidential and must not be reproduced or used without the consent of Eurobox

Ce dessin est confidentiel et ne doit pas être reproduit ou utilisé sans le consentement de Eurobox

STANDARD FEATURES ARE NOT LISTED IN THIS HOLE TABLE			
HOLE TABLE - FRONT VIEW (CUSTOM FEATURE ONLY)			
CUT-OUT	XDIM	YDIM	DESCRIPTION
1	51.000	3.000	RND Ø0.201 THREAD 1/4-20 UNC
2	45.000	3.000	RND Ø0.201 THREAD 1/4-20 UNC
3	39.000	3.000	RND Ø0.201 THREAD 1/4-20 UNC
4	33.000	3.000	RND Ø0.201 THREAD 1/4-20 UNC
5	21.000	3.000	RND Ø0.201 THREAD 1/4-20 UNC
6	15.000	3.000	RND Ø0.201 THREAD 1/4-20 UNC
7	9.000	3.000	RND Ø0.201 THREAD 1/4-20 UNC
8	3.000	3.000	RND Ø0.201 THREAD 1/4-20 UNC

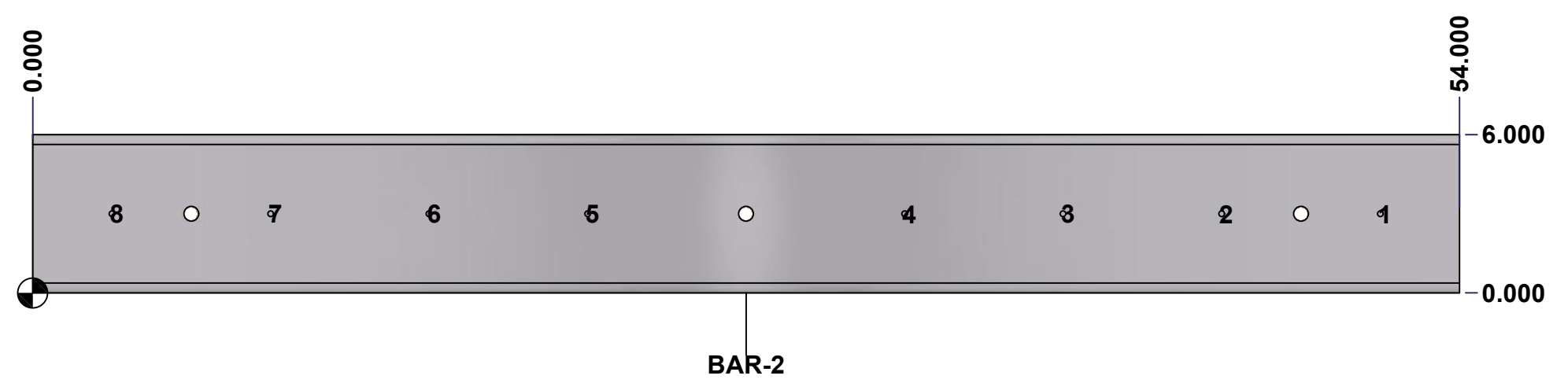

	Description	Status
	Rounded Edge Aluminum Bar 3/4" x 6"	(NULL)
	Part Number Numéro Pièce	Rev.
	1412BTSS062503DTBAR2-P	8
		0
		14

This drawing is confidential and must not be reproduced or used without the consent of Eurobox

Ce dessin est confidentiel et ne doit pas être reproduit ou utilisé sans le consentement de Eurobox

STANDARD FEATURES ARE NOT LISTED IN THIS HOLE TABLE

HOLE TABLE - FRONT VIEW (CUSTOM FEATURE ONLY)

CUT-OUT	XDIM	YDIM	DESCRIPTION
1	51.000	3.000	RND Ø0.201 THREAD 1/4-20 UNC
2	45.000	3.000	RND Ø0.201 THREAD 1/4-20 UNC
3	39.000	3.000	RND Ø0.201 THREAD 1/4-20 UNC
4	33.000	3.000	RND Ø0.201 THREAD 1/4-20 UNC
5	21.000	3.000	RND Ø0.201 THREAD 1/4-20 UNC
6	15.000	3.000	RND Ø0.201 THREAD 1/4-20 UNC
7	9.000	3.000	RND Ø0.201 THREAD 1/4-20 UNC
8	3.000	3.000	RND Ø0.201 THREAD 1/4-20 UNC

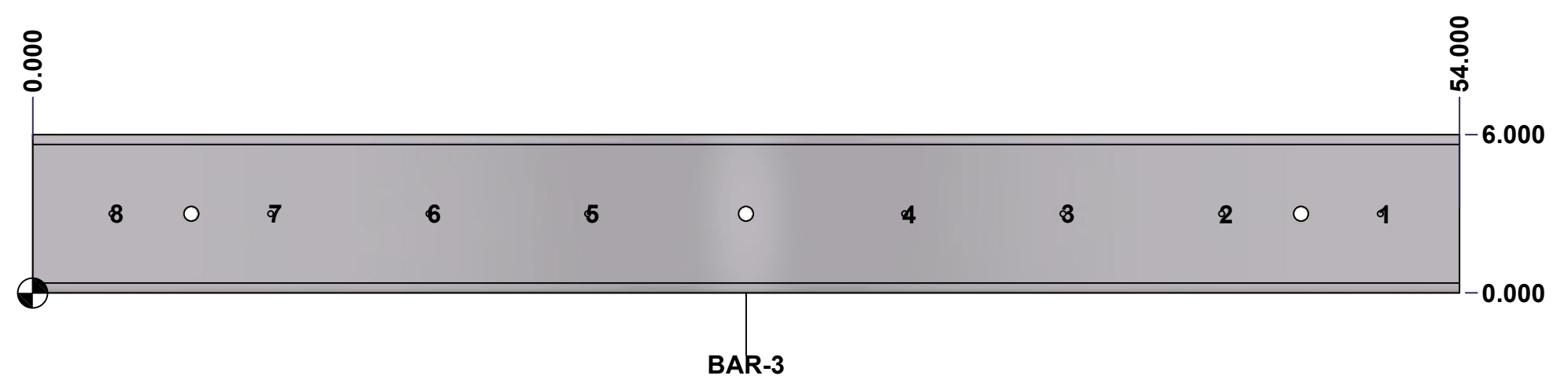

BAR-3

	Description	Status
	Rounded Edge Aluminum Bar 3/4" x 6"	(NULL)
Part Number Numéro Pièce	1412BTSS062503DTBAR3-P	Rev. 9
	0	14

This drawing is confidential and must not be reproduced or used without the consent of EXM

Ce dessin est confidentiel et ne doit pas être reproduit ou utilisé sans le consentement de EXM



TOP

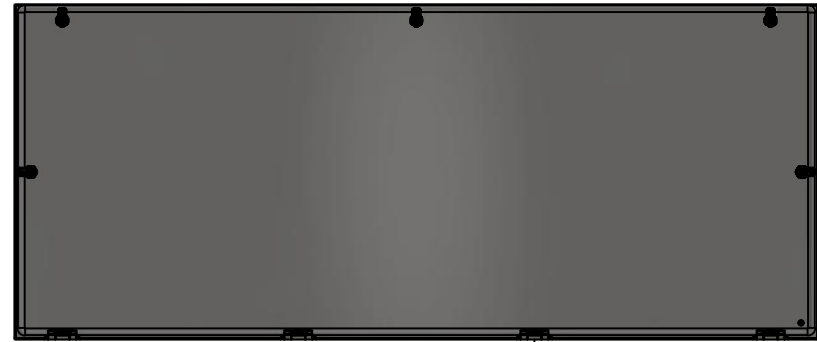

BACK

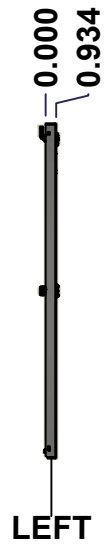

LEFT

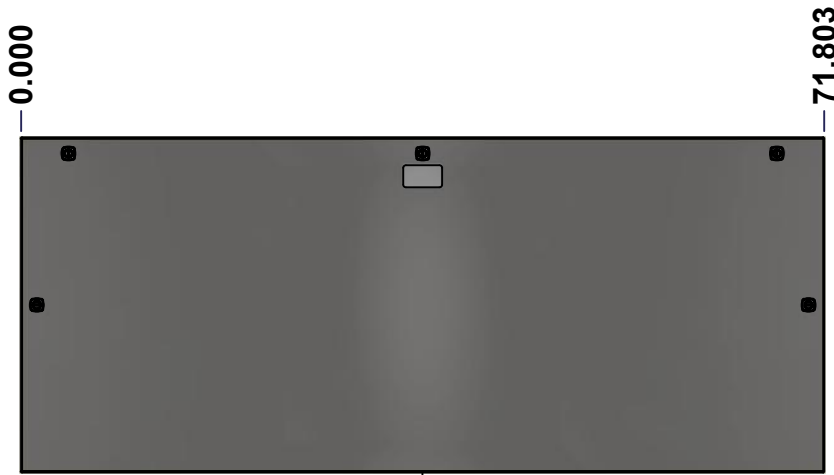

FRONT

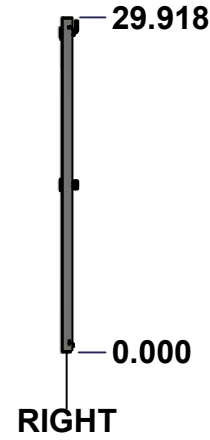

RIGHT



BOTTOM

No.	Revisions	Date	By/Par



Isometric View



Tél: (450) 979-4373
 Fax: (450) 979-4626
www.exmweb.com

Flatness
Aplatissement

Max 3.0mm

Projection

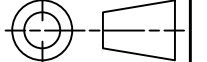

Customer Client	Date
Drawn By / Dessiné Par: BoxCad: BoxCad	Date: 02-Nov-22
Material / Matière: 14 Ga Stainless Steel 304 (1.7mm)	

Color / Couleur: Unpainted	Finish / Fini: Brushed
----------------------------	------------------------

Description: 1412BTSS 30" x 72" Cover	Detail Rev.
---------------------------------------	-------------

Part Number / Numéro Pièce: 1412BTSS062503DTC	Rev. 0	10	14
---	--------	----	----

SEE BILL OF MATERIAL ON LAST PAGE

This drawing is confidential and must not be reproduced or used without the consent of Eurobox

Ce dessin est confidentiel et ne doit pas être reproduit ou utilisé sans le consentement de Eurobox

STANDARD FEATURES ARE NOT LISTED IN THIS HOLE TABLE

HOLE TABLE - FRONT VIEW (CUSTOM FEATURE ONLY)

CUT-OUT	XDIM	YDIM	DESCRIPTION
1	1.500	1.486	GND STUD M6 x 16mm (Inside)
2	70.379	14.959	LOCK 880 SCQ4-SLSS6 @ 0.0°
3	1.424	14.959	LOCK 880 SCQ4-SLSS6 @ 180.0°
4	67.553	28.494	LOCK 880 SCQ4-SLSS6 @ 90.0°
5	35.902	28.494	LOCK 880 SCQ4-SLSS6 @ 90.0°
6	4.250	28.494	LOCK 880 SCQ4-SLSS6 @ 90.0°

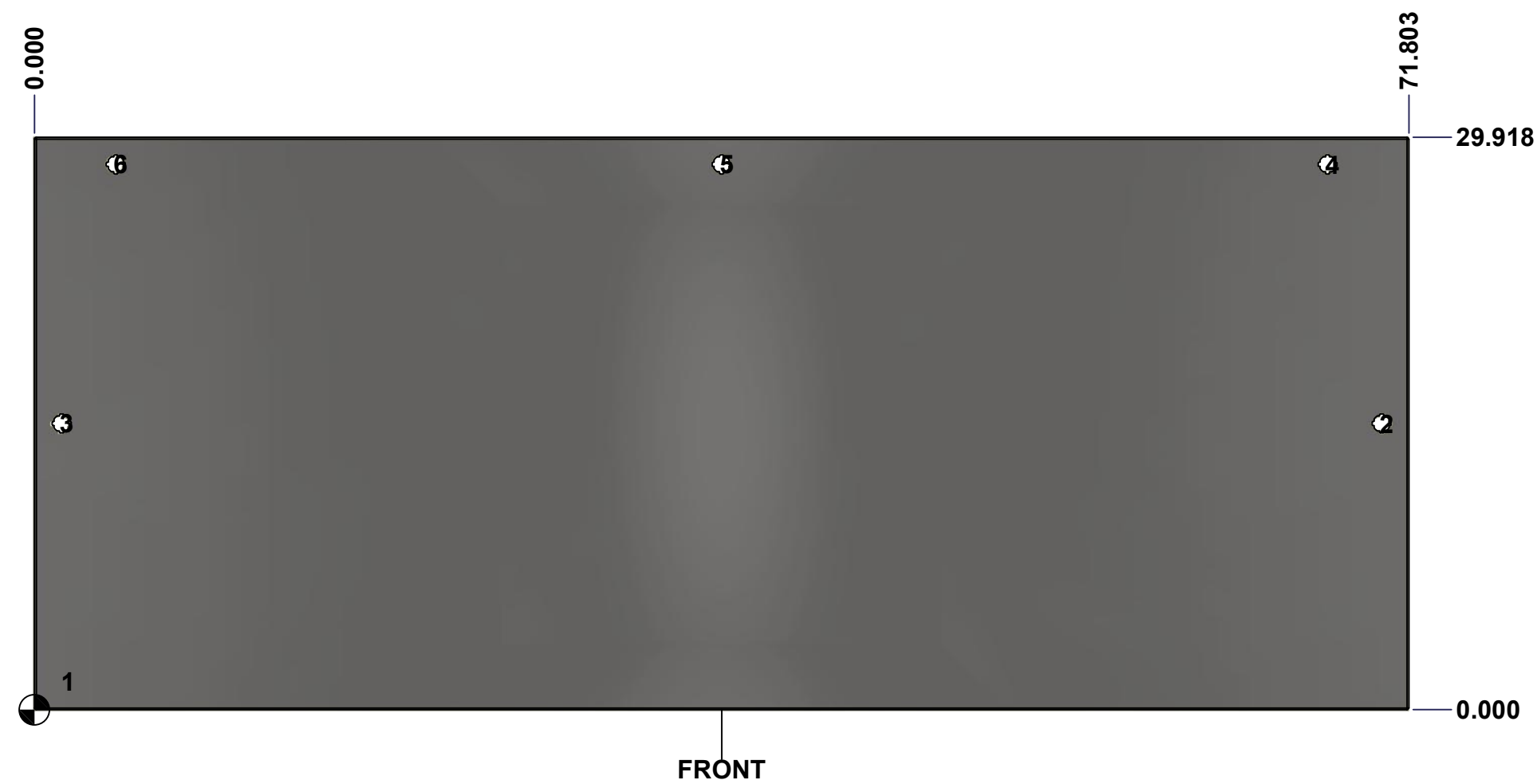

	Description	Status
	1412BTSS 30" x 72" Cover	(NULL)
	Part Number Numéro Pièce	Rev.
	1412BTSS062503DTC	0 / 11
		14

This drawing is confidential and must not be reproduced or used without the consent of EXM

Ce dessin est confidentiel et ne doit pas être reproduit ou utilisé sans le consentement de EXM

No.	Revisions	Date	By/Par



Isometric View



Tél: (450) 979-4373
 Fax: (450) 979-4626
www.exmweb.com

Flatness
Aplatissement
Max 3.0mm
Projection

Customer Client	Date
Drawn By / Dessiné Par: BoxCad: BoxCad	Date: 02-Nov-22
Material / Matière: 14 Ga Stainless Steel 304 (1.7mm)	

Color / Couleur: Unpainted	Finish / Fini: Brushed
Description: 1412BTSS 30" x 72" Cover	
Detail Rev.	

Part Number / Numéro Pièce: 1412BTSS062503DTC	Rev. 0	12 / 14
--	--------	---------

Qty	Part Name	Rev	Description
1	1412BTSS062503DTG	0	1412BTSS 30" x 72" Cover Gasket
4	STK-K-09850	6	5412 ESS Hinge with 2 Captive Hinge Pins
1	STK-Q-16095	0	M6 x 16mm Stainless Steel Ground Stud
1	STK-S-00100	0	3.5" x 2" Silver Milar Flexcon Sticker
1	1412BTSS062503DTC-P	0	1412BTSS 30" x 72" Cover Part
5	880 SCQ4-SLSS6	7	5412 ESS 1/4 Turn Lock
Parts List			

This drawing is confidential and must not be reproduced or used without the consent of EXM

Ce dessin est confidentiel et ne doit pas être reproduit ou utilisé sans le consentement de EXM



TOP

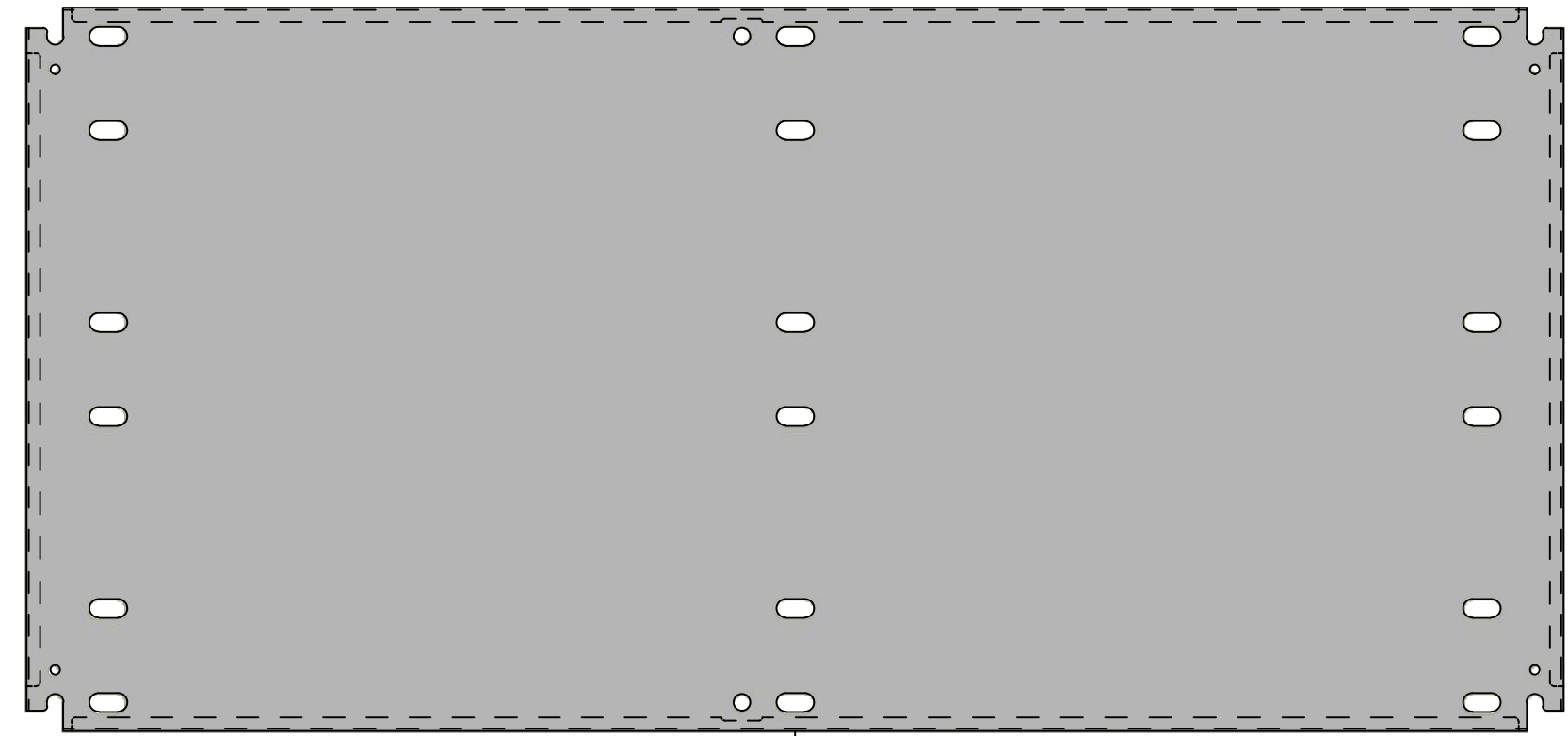

FRONT

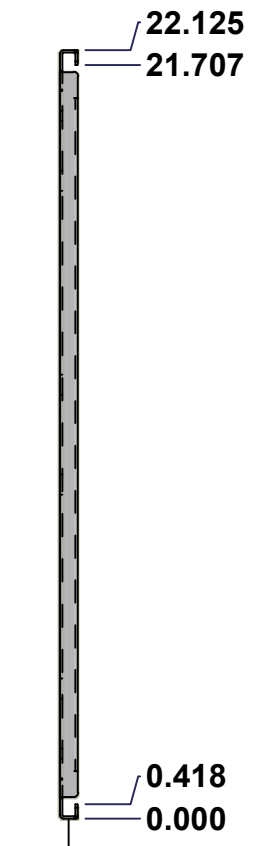

RIGHT

No.	Revisions	Date	By/Par



Isometric View

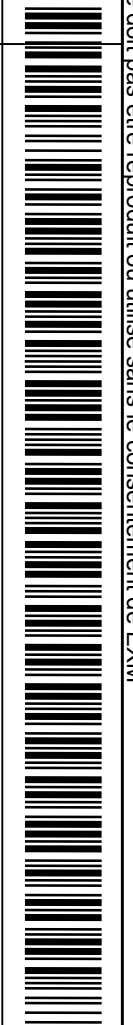

Tél: (450) 979-4373
 Fax: (450) 979-4626
www.exmweb.com

Flatness
Aplatissement
Max 3.0mm
Projection

Customer Client	Date
Drawn By Dessiné Par BoxCad: BoxCad	Date 02-Nov-22
Material Matière 14 Ga Cold Rolled A1008 CS Type B (1.7mm)	
Color Couleur White RAL9003	Finish Fini Smooth
Description 1412BTSS 22.125" x 47" Inner Panel	
Detail Rev.	
Part Number Numéro Pièce 1412BTSS062503DTIP1	Rev. 13 0 14

SEE BILL OF MATERIAL ON LAST PAGE

This drawing is confidential and must not be reproduced or used without the consent of EXM

Ce dessin est confidentiel et ne doit pas être reproduit ou utilisé sans le consentement de EXM

No.	Revisions	Date	By/Par

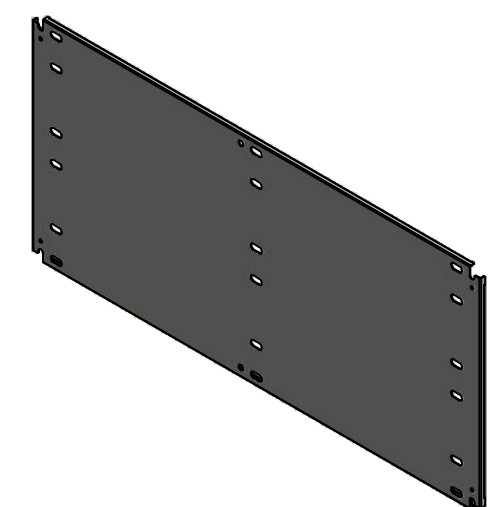

Isometric View

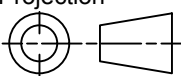

 Tél: (450) 979-4373 Fax: (450) 979-4626 www.exmweb.com		Flatness Aplatissement Max 3.0mm Projection 
Customer Client	Date	
Drawn By Dessiné Par	BoxCad: BoxCad	Date 02-Nov-22
Material Matière	14 Ga Cold Rolled A1008 CS Type B (1.7mm)	
Color Couleur	White RAL9003	Finish Fini Smooth
Description		Detail Rev.
1412BTSS 22.125" x 47" Inner Panel		
Part Number Numéro Pièce	Rev.	14
1412BTSS062503DTIP1	0	14

Qty	Part Number	Rev	Description
1	STK-P-02401S	0	Powder Paint (White / Smooth)
1	1412BTSS062503DTIP1-P	0	1412BTSS 22.125" x 72" Inner Panel Part
Parts List			