

This drawing is confidential and must not be reproduced or used without the consent of EXM

Ce dessin est confidentiel et ne doit pas être reproduit ou utilisé sans le consentement de EXM

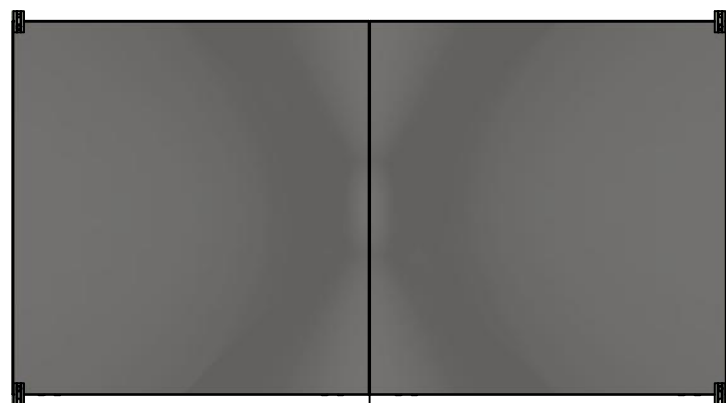

TOP



LEFT

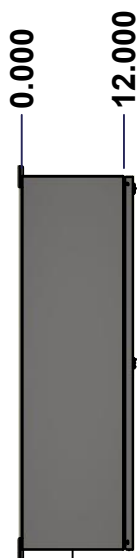

LEFT

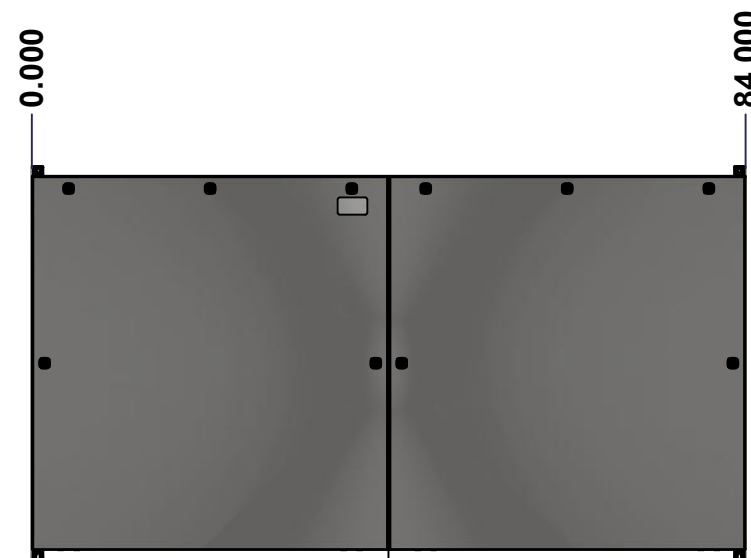

FRONT

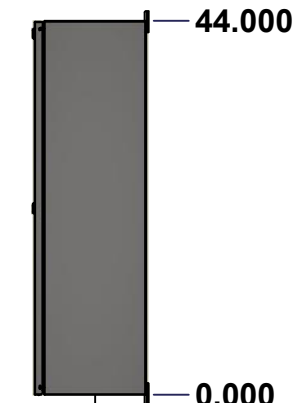

RIGHT



BOTTOM

No.	Revisions	Date	By/Par

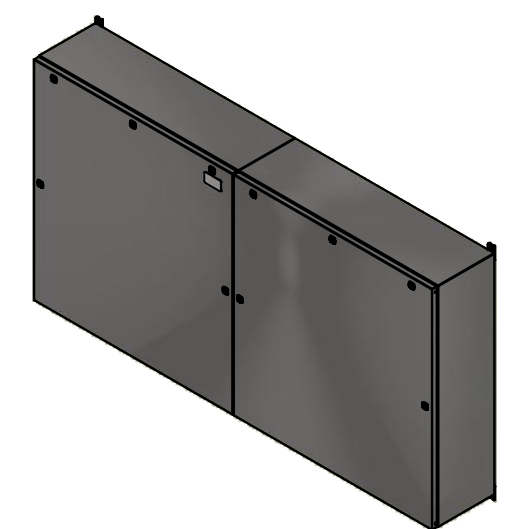

Isometric View



Tél: (450) 979-4373
 Fax: (450) 979-4626
www.exmweb.com

Flatness
Aplatissement
Max 3.0mm
Projection

Customer Client	Date
Drawn By Dessiné Par BoxCad: BoxCad	Date 2022-09-27
Material Matière 14 Ga Stainless Steel 304 (1.7mm)	
Color Couleur Unpainted	Finish Fini Brushed
Description 1412BTSS 2500A - 5Wires x 84" Assembly	Detail Rev.
Part Number Numéro Pièce 1412BTSS072505	Rev. 0

SEE BILL OF MATERIAL ON LAST PAGE

This drawing is confidential and must not be reproduced or used without the consent of Eurobox

STANDARD FEATURES ARE NOT LISTED IN THIS HOLE TABLE

Ce dessin est confidentiel et ne doit pas être reproduit ou utilisé sans le consentement de Eurobox

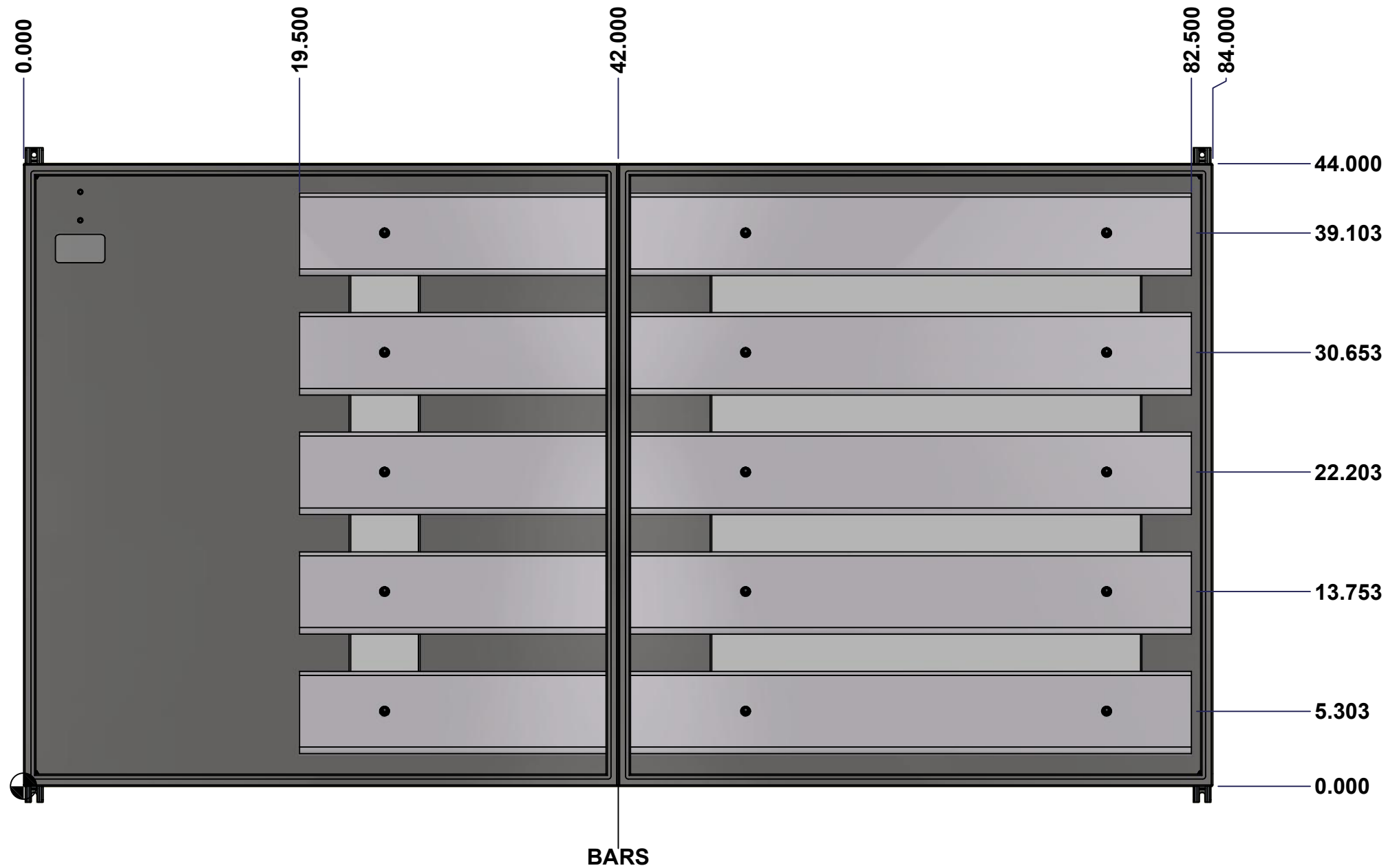

	Description		Status
	1412BTSS 2500A - 5Wires x 84" Assembly		(NULL)
Part Number		Rev.	2
Numéro Pièce		0	13
1412BTSS072505			

This drawing is confidential and must not be reproduced or used without the consent of EXM

Ce dessin est confidentiel et ne doit pas être reproduit ou utilisé sans le consentement de EXM

NOTE	
ITEM	DESCRIPTION
1	NEMA 4X Enclosure
2	C/W Standard ground studs on box and cover
3	W/O Standard door stiffener
4	C/W Special inner panel (Sold separately)
5	C/W Standard inner panel mounting studs

No.	Revisions	Date	By/Par

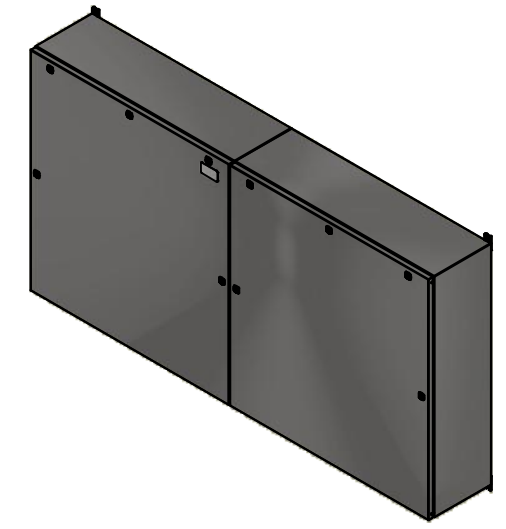

Isometric View



PACKING		
ITEM	QTY	DESCRIPTION
Cardboard sleeve	2	Top and Bottom
Cardboard strip	2	Between back of enclosure and inner panel
Plastic bag	1	To protect cover surface and inside gasket
Cardboard corner	4	To reinforced for the plastic strap tightening
Plastic strap - Black	2	To Squeeze 2 cardboard sleeve together
Packaging label	3	White label with PN
Plastic strap- Green	2	To secure the enclosure to the wood pallet
Wood Pallet	1	2" deeper and 3" larger than enclosure size

6	STK-Q-04051-07	8	M6 x 7mm Stainless Steel Hexagon Socket Head Machine Screw with Nyseal
1	885 ESMF2	0	885 ESMF2 Stainless Steel Mounting Feet Kit
1	1412BTSS072505IP2	0	1412BTSS 38.425" x 28" Right Inner Panel
1	1412BTSS072505BAR1-P	0	Rounded Edge Aluminum Bar 3/4" x 6"
1	1412BTSS072505BAR2-P	0	Rounded Edge Aluminum Bar 3/4" x 6"
1	1412BTSS072505BAR3-P	0	Rounded Edge Aluminum Bar 3/4" x 6"
1	1412BTSS072505BAR4-P	0	Rounded Edge Aluminum Bar 3/4" x 6"
1	1412BTSS072505BAR5-P	0	Rounded Edge Aluminum Bar 3/4" x 6"
1	1412BTSS072505IP1	0	1412BTSS 38.425" x 56" Inner Panel
15	STK-A-67400	0	Buss Bar Insulator Kit
1	STK-K-01800	5	5412 ES Accessory Kit
27	STK-Q-07310	2	Flange Lock Nut M8
12	STK-Q-07610	8	M8 Plastic Spacer 22.2mm
1	1412BTSS072505B	0	1412BTSS 44" x 84" x 12" Body
1	1412BTSS072505C	0	1412BTSS 44" x 84" Cover
Qty	Part Number	Rev	Description
Parts List			



Tél: (450) 979-4373
Fax: (450) 979-4626
www.exmweb.com

Flatness
Aplatissement
Max 3.0mm

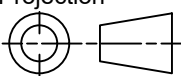
Projection

Customer Client
Date

Drawn By
Dessiné Par BoxCad: BoxCad
Date 2022-09-27

Material
Matière 14 Ga Stainless Steel 304 (1.7mm)

Color
Couleur Unpainted
Finish
Fini Brushed

Description
1412BTSS 2500A - 5Wires x 84" Assembly
Detail Rev.

Part Number
Numéro Pièce
1412BTSS072505

Rev. 0

This drawing is confidential and must not be reproduced or used without the consent of EXM

Ce dessin est confidentiel et ne doit pas être reproduit ou utilisé sans le consentement de EXM

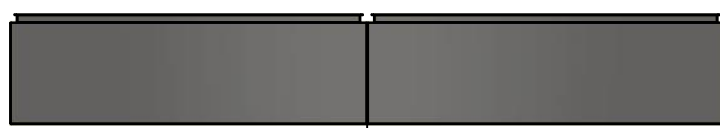

TOP

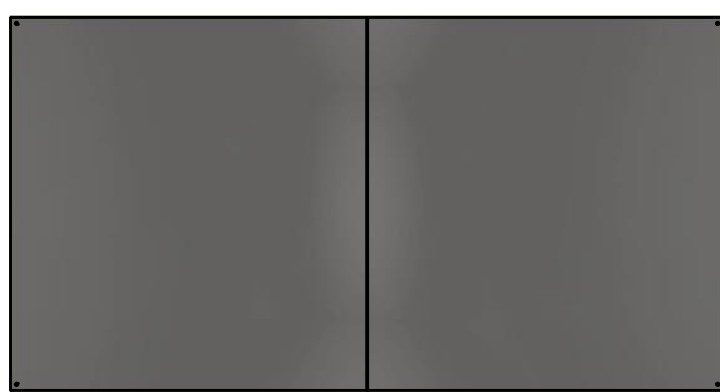

BACK

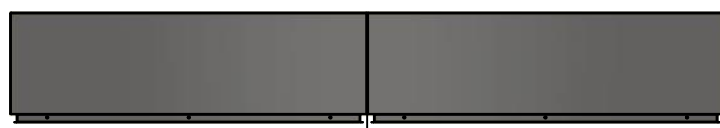

BOTTOM

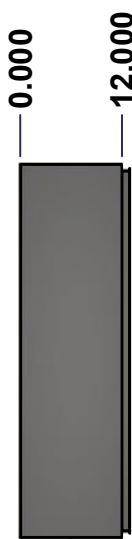

LEFT

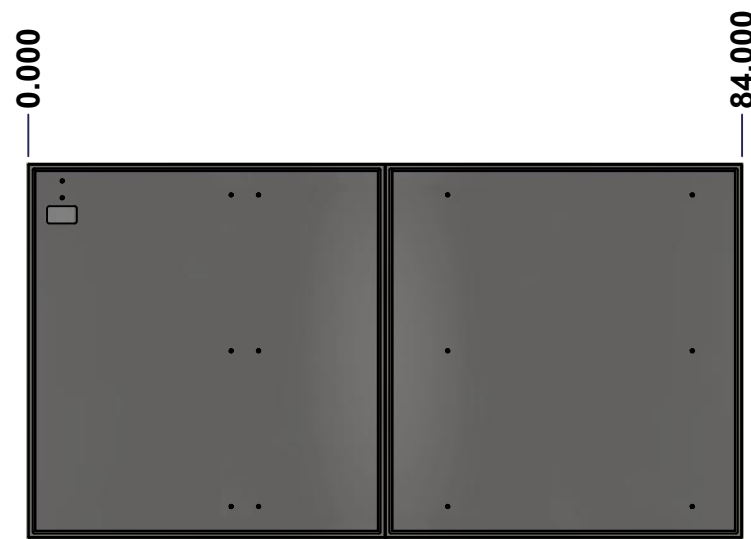

FRONT

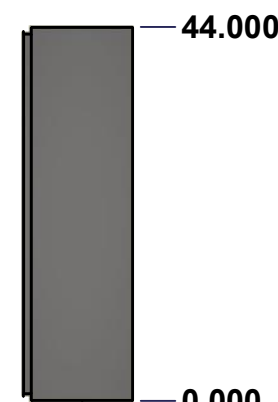

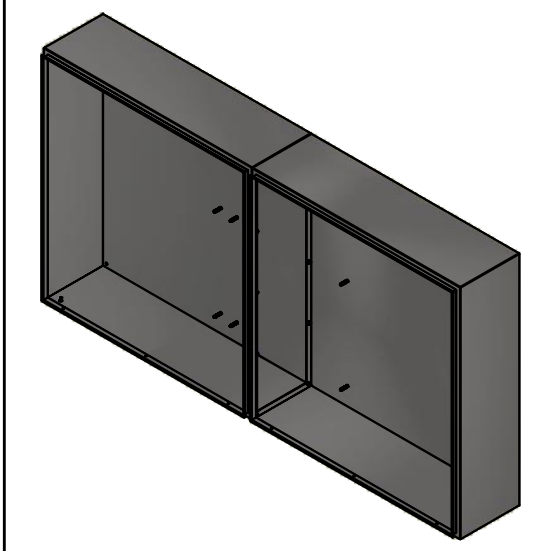

RIGHT

No.	Revisions	Date	By/Par

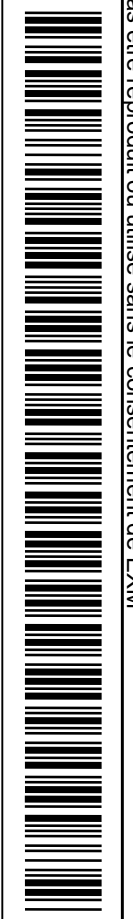

Isometric View

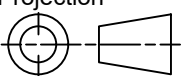

 Tél: (450) 979-4373 Fax: (450) 979-4626 www.exmweb.com	Flatness Aplatissement	Max 3.0mm
	Projection	
Customer Client	Date	
Drawn By Dessiné Par	BoxCad: BoxCad	Date 2022-09-27
Material Matière	14 Ga Stainless Steel 304 (1.7mm)	
Color Couleur	Unpainted	Finish Fini Brushed
Description	Detail Rev.	
1412BTSS 44" x 84" x 12" Body		
Part Number Numéro Pièce	Rev.	4
1412BTSS072505B	0	13

SEE BILL OF MATERIAL ON LAST PAGE

This drawing is confidential and must not be reproduced or used without the consent of Eurobox

Ce dessin est confidentiel et ne doit pas être reproduit ou utilisé sans le consentement de Eurobox

STANDARD FEATURES ARE NOT LISTED IN THIS HOLE TABLE

HOLE TABLE - BACK VIEW (CUSTOM FEATURE ONLY)

CUT-OUT	XDIM	YDIM	DESCRIPTION
1	80.000	42.000	GND STUD M8 x 35mm (Inside)
2	80.000	40.000	GND STUD M8 x 35mm (Inside)
3	5.875	40.350	IP STUD M8 x 35mm (Inside)
4	34.625	40.350	IP STUD M8 x 35mm (Inside)
5	5.875	3.675	IP STUD M8 x 35mm (Inside)
6	34.625	3.675	IP STUD M8 x 35mm (Inside)
7	5.875	22.013	IP STUD M8 x 35mm (Inside)
8	34.625	22.013	IP STUD M8 x 35mm (Inside)
9	56.875	40.350	IP STUD M8 x 35mm (Inside)
10	60.125	40.350	IP STUD M8 x 35mm (Inside)
11	56.875	3.675	IP STUD M8 x 35mm (Inside)
12	60.125	3.675	IP STUD M8 x 35mm (Inside)
13	56.875	22.013	IP STUD M8 x 35mm (Inside)
14	60.125	22.013	IP STUD M8 x 35mm (Inside)

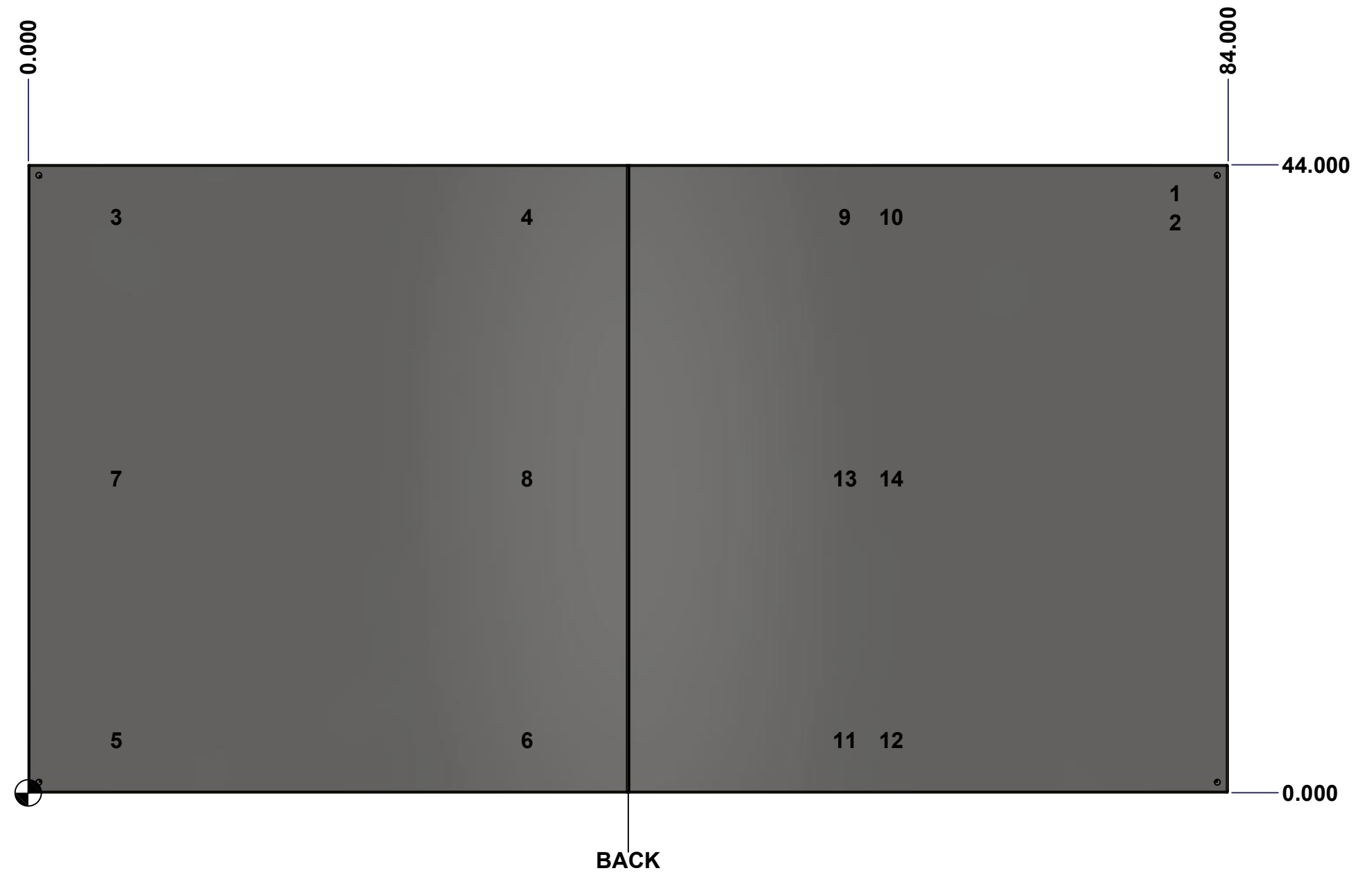

	Description	Status
	1412BTSS 44" x 84" x 12" Body	(NULL)
Part Number Numéro Pièce 1412BTSS072505B	Rev.	5
	0	13

This drawing is confidential and must not be reproduced or used without the consent of EXM

Ce dessin est confidentiel et ne doit pas être reproduit ou utilisé sans le consentement de EXM

No.	Revisions	Date	By/Par

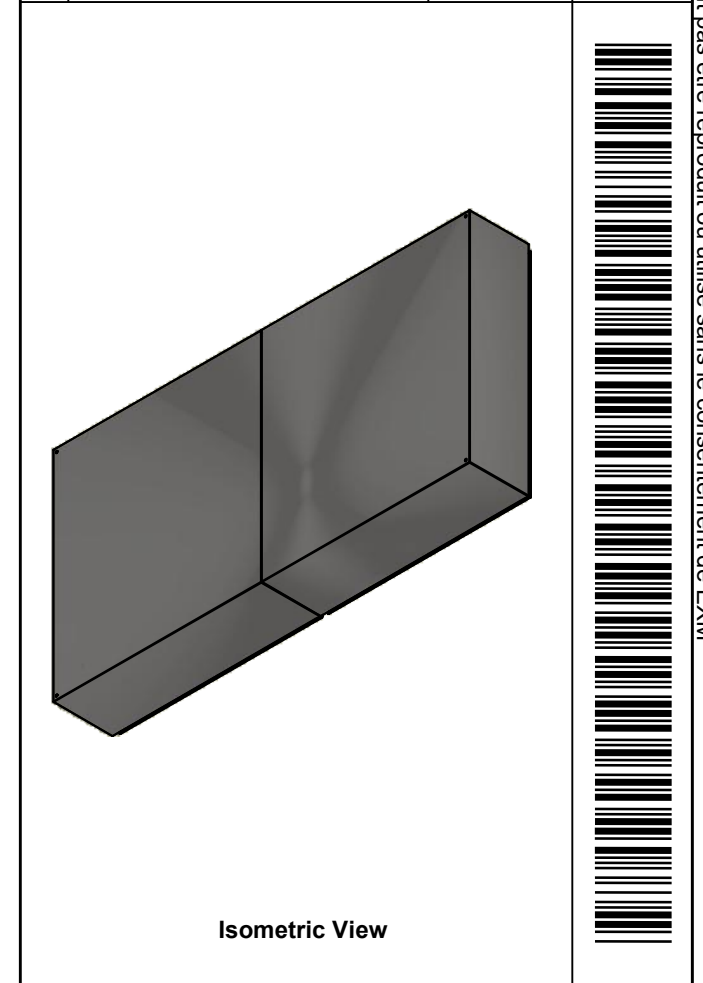

 Tél: (450) 979-4373
 Fax: (450) 979-4626
www.exmweb.com

Flatness
 Aplatissement
 Max 3.0mm
Projection

Customer Client	Date
Drawn By / Dessiné Par: BoxCad: BoxCad	Date: 2022-09-27

Material / Matière: 14 Ga Stainless Steel 304 (1.7mm)

Color / Couleur: Unpainted	Finish / Fini: Brushed
----------------------------	------------------------

Description: 1412BTSS 44" x 84" x 12" Body

Detail Rev.

Part Number / Numéro Pièce: 1412BTSS072505B	Rev. 0	6
		13

Qty	Part Number	Rev	Description
1	1412BTSS072505B-P	0	1412BTSS 44" x 84" x 12" Body Part
1	1412BTSS072505E-P	0	1412BTSS 44" x 84" x 12" Right Body Part
1	STK-G-00701	0	1" x 1/4" Self-Adhesive Neoprene Gasket
10	STK-Q-00260	1	M6 x 13mm Carriage Bolt
10	STK-Q-07220	1	M6 Nylon Insert Lock Nut
14	STK-Q-16020	1	Stud M8 x 35mm Stainless Steel
2	STK-Q-16095	0	M6 x 16mm Stainless Steel Ground Stud
1	STK-S-00100	0	3.5" x 2" Silver Milar Flexcon Sticker
Parts List			

This drawing is confidential and must not be reproduced or used without the consent of EXM

Ce dessin est confidentiel et ne doit pas être reproduit ou utilisé sans le consentement de EXM

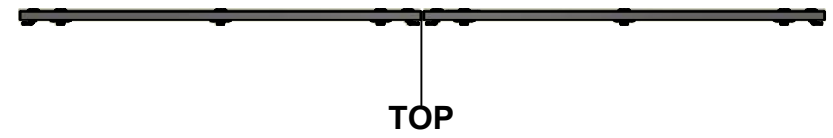

TOP

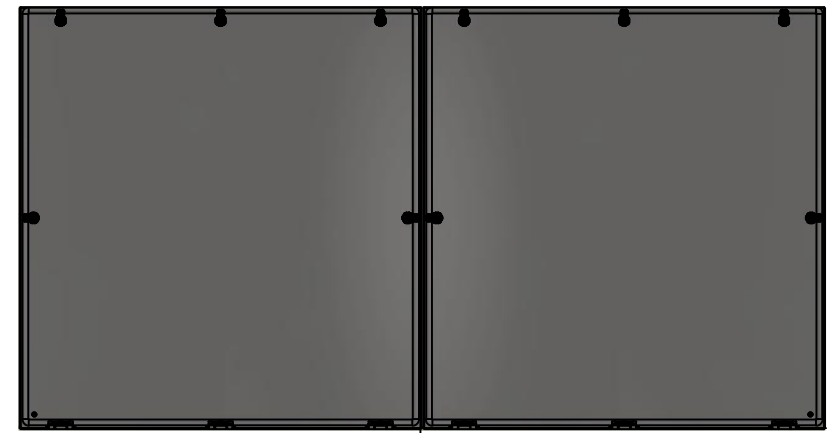

BACK

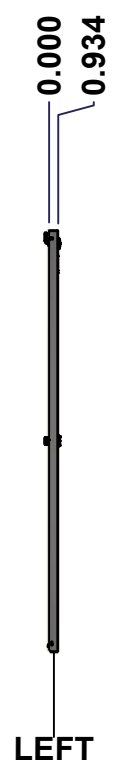

LEFT

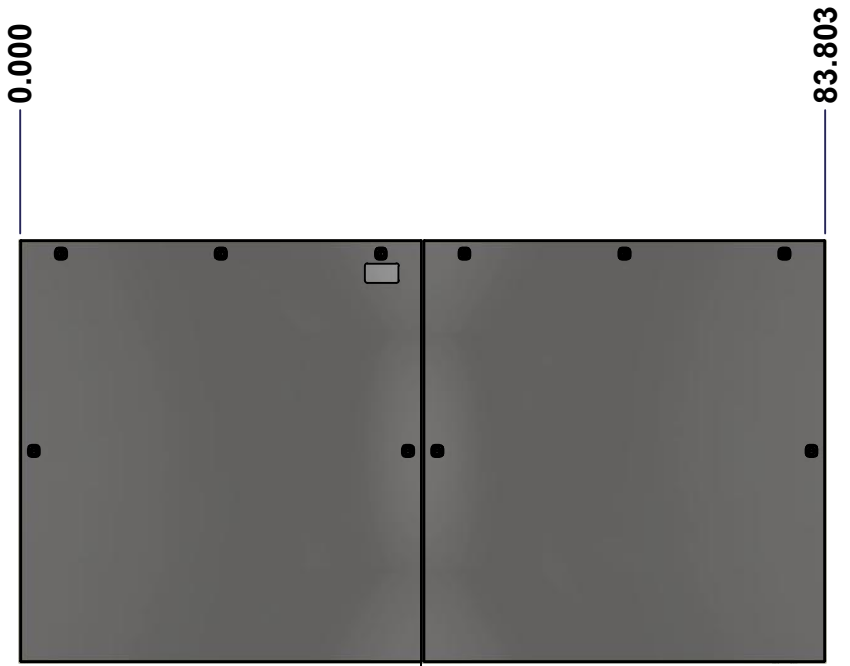

FRONT

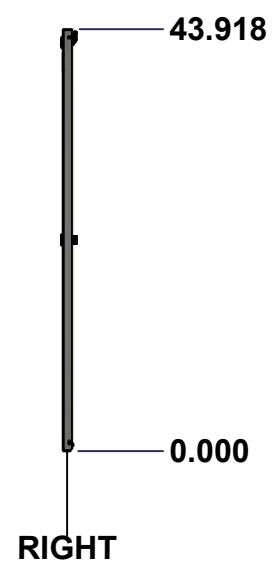

RIGHT



BOTTOM

No.	Revisions	Date	By/Par



Isometric View

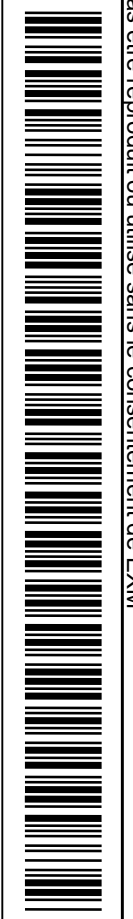

Tél: (450) 979-4373
 Fax: (450) 979-4626
www.exmweb.com

Flatness
Aplatissement
Max 3.0mm
Projection

Customer Client	Date
Drawn By Dessiné Par BoxCad: BoxCad	Date 2022-09-27
Material Matière 14 Ga Stainless Steel 304 (1.7mm)	
Color Couleur Unpainted	Finish Fini Brushed

Description 1412BTSS 44" x 84" Cover	Detail Rev.
Part Number Numéro Pièce 1412BTSS072505C	Rev. 7

SEE BILL OF MATERIAL ON LAST PAGE

Rev. 0	7	13
--------	---	----

This drawing is confidential and must not be reproduced or used without the consent of Eurobox

Ce dessin est confidentiel et ne doit pas être reproduit ou utilisé sans le consentement de Eurobox

STANDARD FEATURES ARE NOT LISTED IN THIS HOLE TABLE

HOLE TABLE - FRONT VIEW (CUSTOM FEATURE ONLY)

CUT-OUT	XDIM	YDIM	DESCRIPTION
1	1.500	1.486	GND STUD M6 x 16mm (Inside)
2	82.303	1.486	GND STUD M6 x 16mm (Inside)
3	4.250	42.494	LOCK 880 SCQ4-SLSS6 @ 90.0°
4	82.379	21.959	LOCK 880 SCQ4-SLSS6 @ 0.0°
5	43.424	21.959	LOCK 880 SCQ4-SLSS6 @ 180.0°
6	37.553	42.494	LOCK 880 SCQ4-SLSS6 @ 90.0°
7	20.902	42.494	LOCK 880 SCQ4-SLSS6 @ 90.0°
8	40.379	21.959	LOCK 880 SCQ4-SLSS6 @ 0.0°
9	1.424	21.959	LOCK 880 SCQ4-SLSS6 @ 180.0°
10	79.553	42.494	LOCK 880 SCQ4-SLSS6 @ 90.0°
11	62.902	42.494	LOCK 880 SCQ4-SLSS6 @ 90.0°
12	46.250	42.494	LOCK 880 SCQ4-SLSS6 @ 90.0°

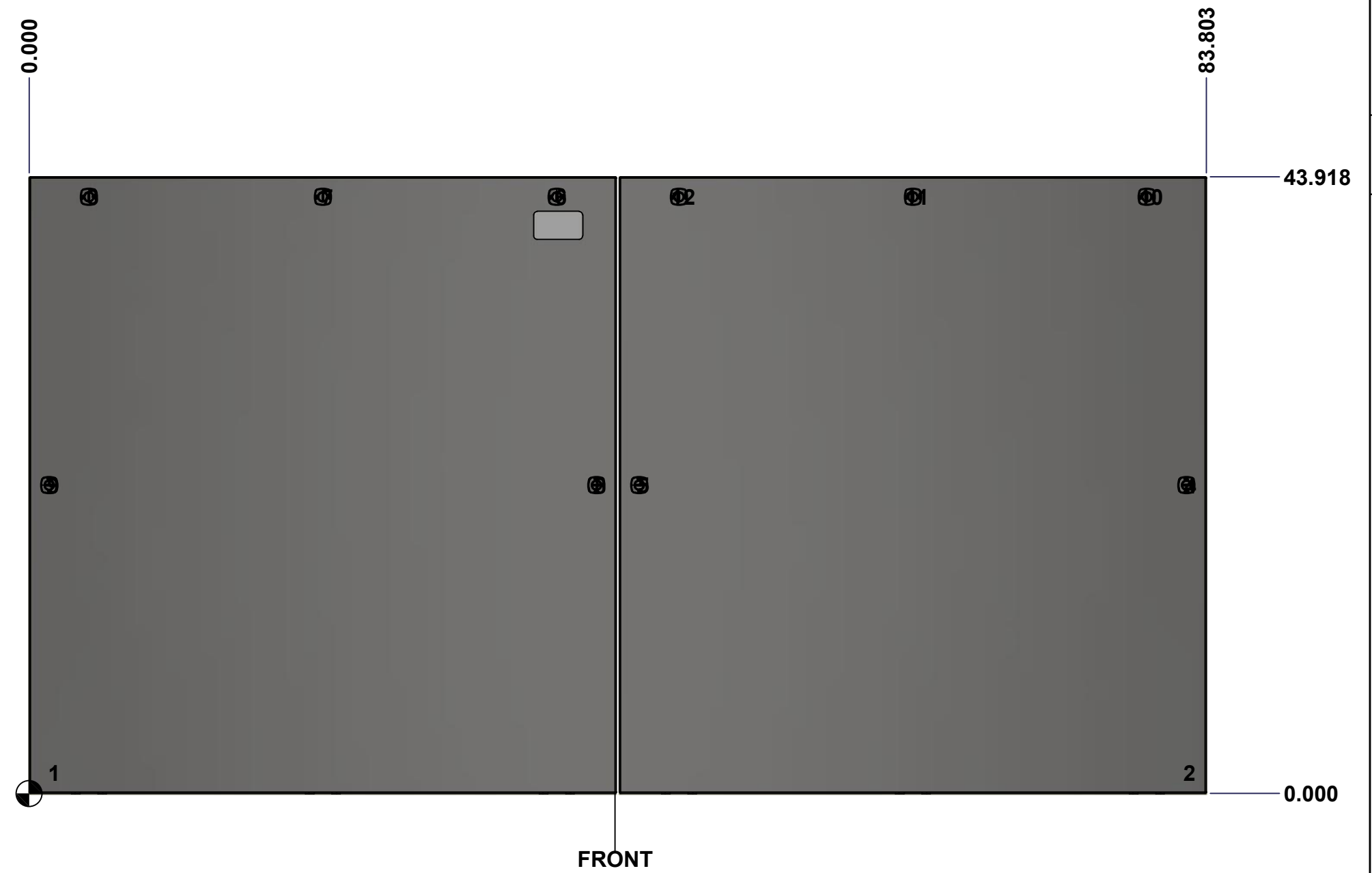

	Description	Status
	1412BTSS 44" x 84" Cover	(NULL)
	Part Number Numéro Pièce	Rev.
	1412BTSS072505C	0 / 8
		13

This drawing is confidential and must not be reproduced or used without the consent of EXM

Ce dessin est confidentiel et ne doit pas être reproduit ou utilisé sans le consentement de EXM

No.	Revisions	Date	By/Par



Isometric View



Tél: (450) 979-4373
 Fax: (450) 979-4626
www.exmweb.com

Flatness
Aplatissement
Max 3.0mm
Projection

Customer Client	Date
Drawn By / Dessiné Par: BoxCad: BoxCad	Date: 2022-09-27

Material / Matière: 14 Ga Stainless Steel 304 (1.7mm)

Color / Couleur: Unpainted	Finish / Fini: Brushed
----------------------------	------------------------

Description: 1412BTSS 44" x 84" Cover	Detail Rev.
---------------------------------------	-------------

Part Number / Numéro Pièce: 1412BTSS072505C	Rev. 0	9
--	--------	---

Qty	Part Name	Rev	Description
2	1412BTSS072505G	0	1412BTSS 44" x 84" Cover Gasket
6	STK-K-09850	6	5412 ESS Hinge with 2 Captive Hinge Pins
2	STK-Q-16095	0	M6 x 16mm Stainless Steel Ground Stud
1	STK-S-00100	0	3.5" x 2" Silver Milar Flexcon Sticker
1	1412BTSS072505C-P	0	1412BTSS 44" x 84" Cover Part
1	1412BTSS072505F-P	0	1412BTSS 44" x 84" Right Cover Part
10	880 SCQ4-SLSS6	7	5412 ESS 1/4 Turn Lock
Parts List			

This drawing is confidential and must not be reproduced or used without the consent of EXM

Ce dessin est confidentiel et ne doit pas être reproduit ou utilisé sans le consentement de EXM

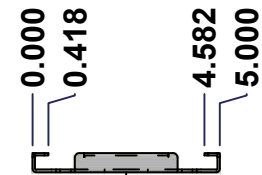

TOP

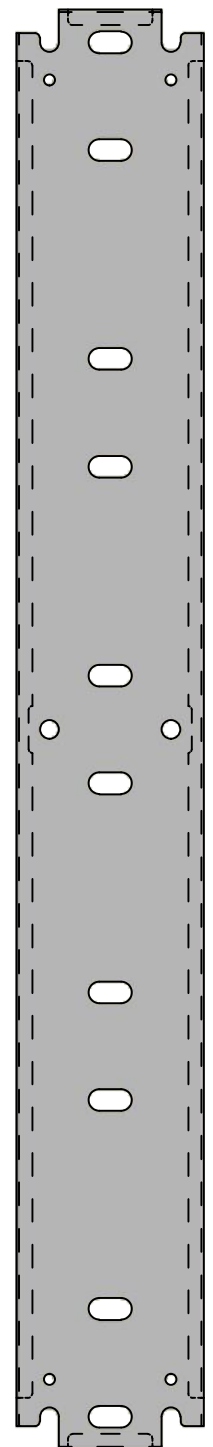

FRONT

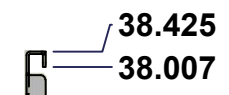

RIGHT

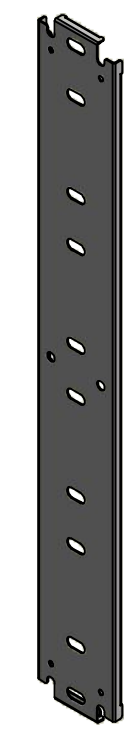
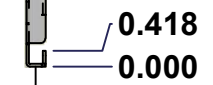

Isometric View

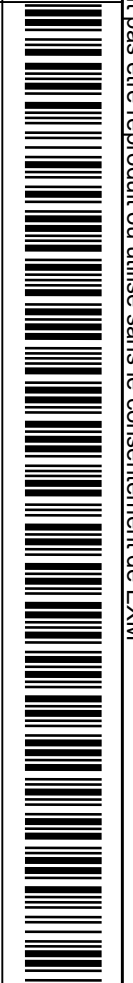

No.	Revisions	Date	By/Par

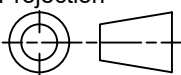
 Tél: (450) 979-4373 Fax: (450) 979-4626 www.exmweb.com		Flatness Aplatissement Max 3.0mm Projection 
Customer Client	Date	
Drawn By Dessiné Par	BoxCad: BoxCad	Date 2022-09-27
Material Matière	14 Ga Cold Rolled A1008 CS Type B (1.7mm)	
Color Couleur	White RAL9003	Finish Fini Smooth
Description 1412BTSS 38.425" x 56" Inner Panel		Detail Rev.
Part Number Numéro Pièce	Rev. 0	10 13

SEE BILL OF MATERIAL ON LAST PAGE

1412BTSS072505IP1

This drawing is confidential and must not be reproduced or used without the consent of EXM

Ce dessin est confidentiel et ne doit pas être reproduit ou utilisé sans le consentement de EXM

No.	Revisions	Date	By/Par

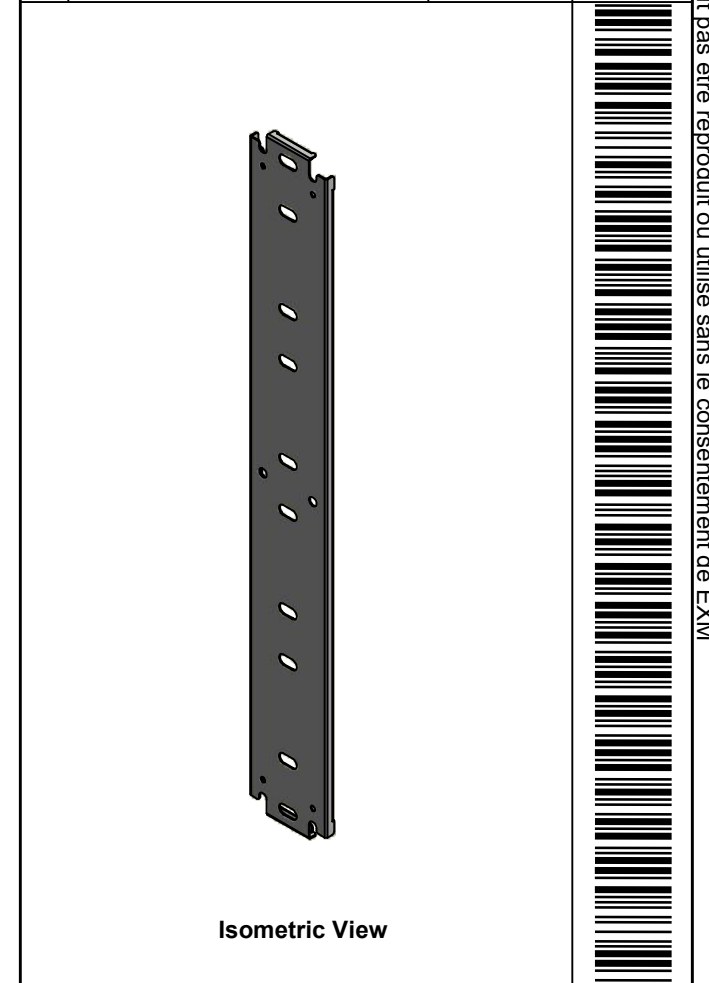

Tél: (450) 979-4373 Fax: (450) 979-4626 www.exmweb.com		Flatness Aplatissement	
		Max 3.0mm	
Customer Client		Date	
Drawn By Dessiné Par BoxCad: BoxCad		Date 2022-09-27	
Material Matière 14 Ga Cold Rolled A1008 CS Type B (1.7mm)			
Color Couleur White RAL9003		Finish Fini Smooth	
Description 1412BTSS 38.425" x 56" Inner Panel			Detail Rev.
Part Number Numéro Pièce 1412BTSS072505IP1		Rev. 0	11 13

Qty	Part Number	Rev	Description
1	STK-P-02401S	0	Powder Paint (White / Smooth)
1	1412BTSS072505IP1-P	0	1412BTSS 38.425" x 84" Inner Panel Part
Parts List			

This drawing is confidential and must not be reproduced or used without the consent of EXM

Ce dessin est confidentiel et ne doit pas être reproduit ou utilisé sans le consentement de EXM

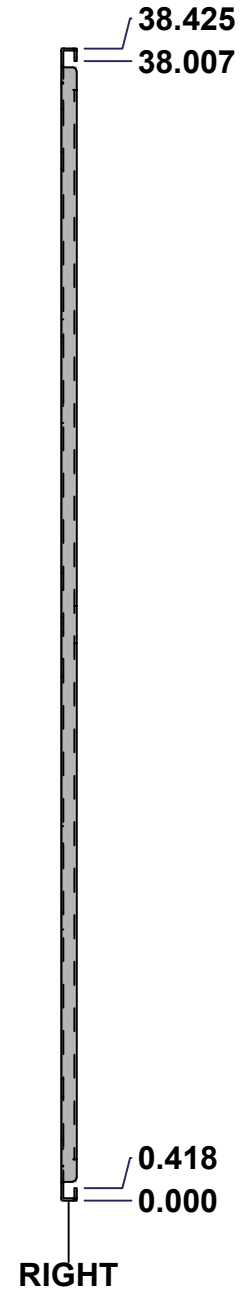
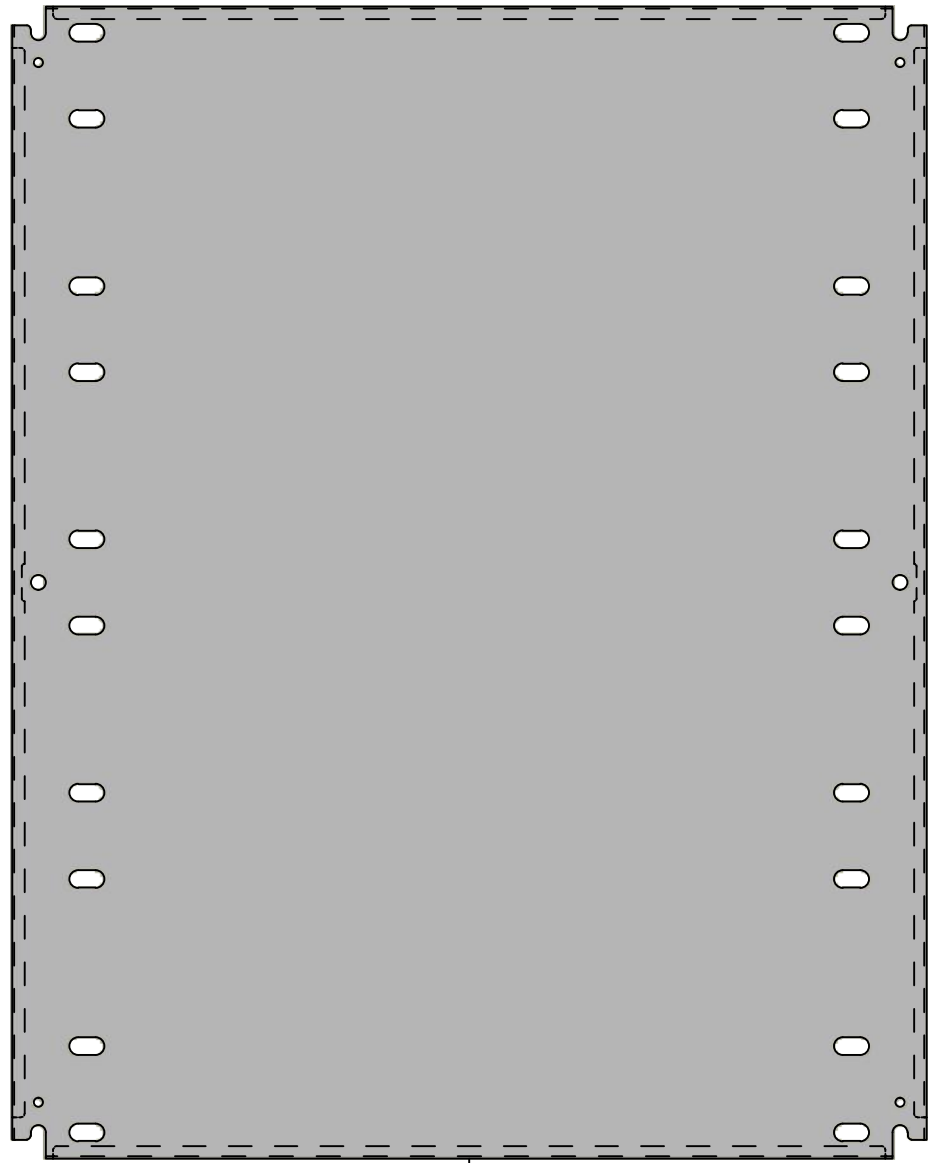
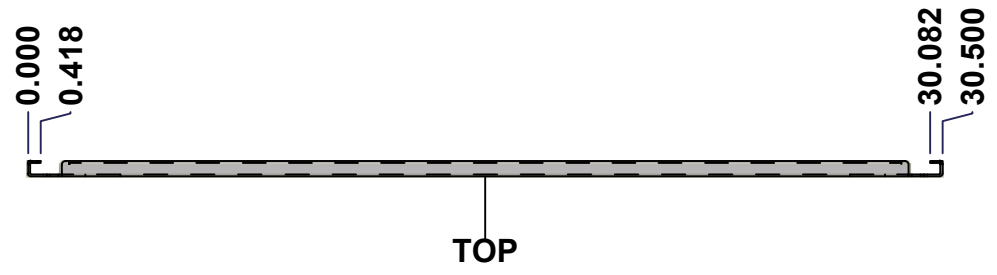

No.	Revisions	Date	By/Par

Isometric View

Tél: (450) 979-4373 Fax: (450) 979-4626 www.exmweb.com	Flatness Aplatissement	Max 3.0mm
	Projection	
Customer Client	Date	
Drawn By Dessiné Par	BoxCad: BoxCad	Date 2022-09-27
Material Matière	14 Ga Cold Rolled A1008 CS Type B (1.7mm)	
Color Couleur	White RAL9003	Finish Fini Smooth
Description	Detail Rev.	
1412BTSS 38.425" x 28" Right Inner Panel		
Part Number Numéro Pièce	Rev.	12
1412BTSS072505IP2	0	13

SEE BILL OF MATERIAL ON LAST PAGE

This drawing is confidential and must not be reproduced or used without the consent of EXM

Ce dessin est confidentiel et ne doit pas être reproduit ou utilisé sans le consentement de EXM

No.	Revisions	Date	By/Par

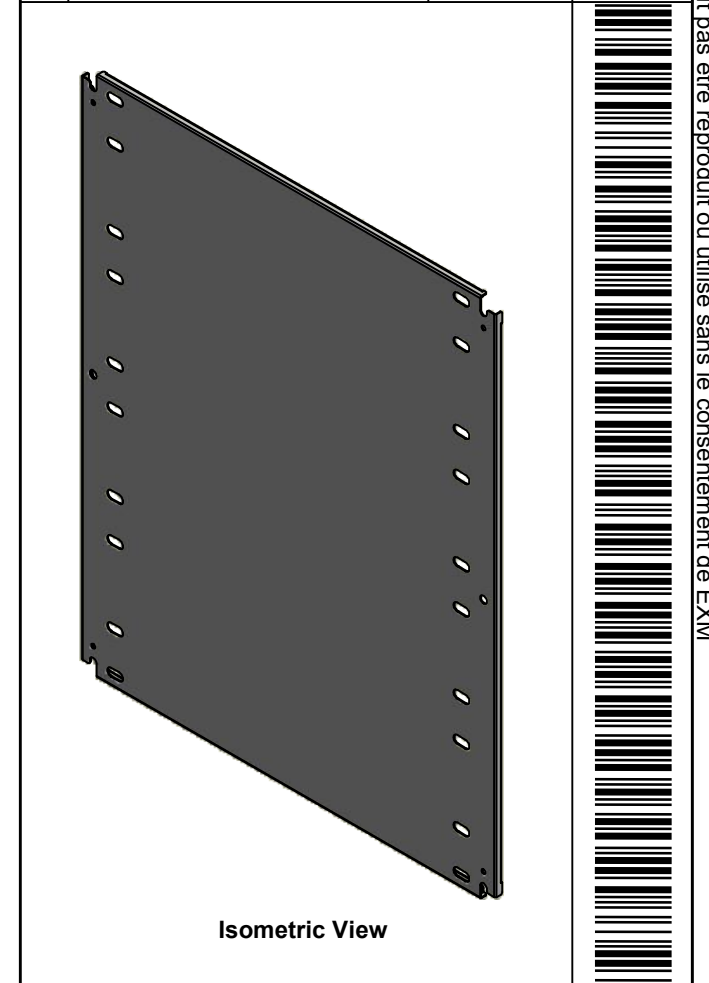

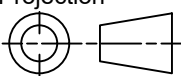
 Tél: (450) 979-4373 Fax: (450) 979-4626 www.exmweb.com		Flatness Aplatissement Max 3.0mm
Customer Client		Projection 
Drawn By / Dessiné Par: BoxCad: BoxCad		Date: 2022-09-27
Material / Matière: 14 Ga Cold Rolled A1008 CS Type B (1.7mm)		
Color / Couleur: White RAL9003	Finish / Fini: Smooth	
Description: 1412BTSS 38.425" x 28" Right Inner Panel		Detail Rev.
Part Number / Numéro Pièce: 1412BTSS072505IP2		Rev. 0 / 13

Qty	Part Number	Rev	Description
1	STK-P-02401S	0	Powder Paint (White / Smooth)
1	1412BTSS072505IP2-P	0	1412BTSS 38.425" x 84" Right Inner Panel Part
Parts List			