

This drawing is confidential and must not be reproduced or used without the consent of EXM

Ce dessin est confidentiel et ne doit pas être reproduit ou utilisé sans le consentement de EXM

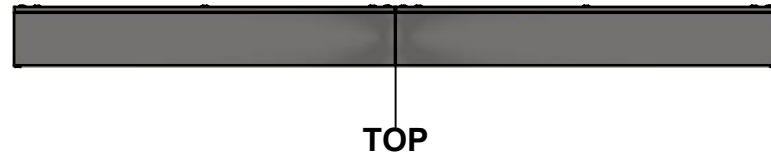

TOP

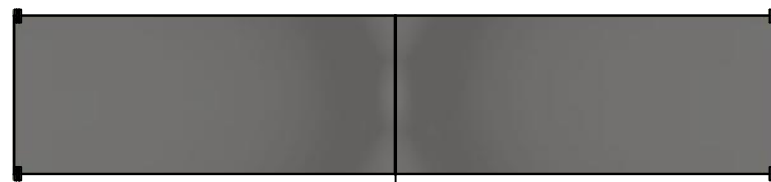

LEFT

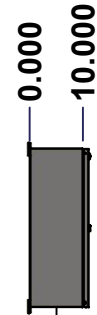

LEFT

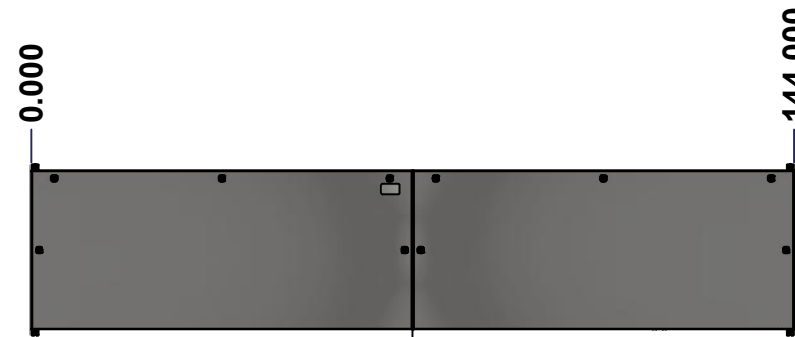

FRONT

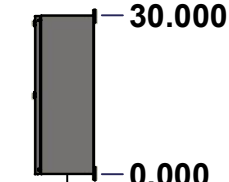

RIGHT



BOTTOM

No.	Revisions	Date	By/Par

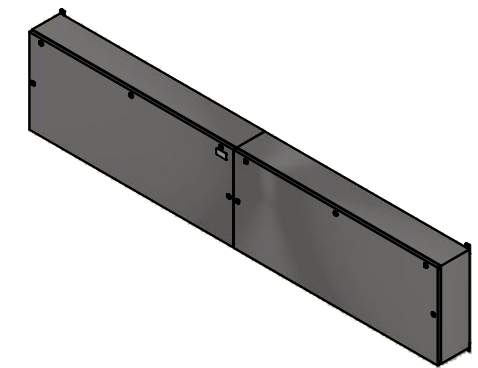

Isometric View



Tél: (450) 979-4373  
 Fax: (450) 979-4626  
[www.exmweb.com](http://www.exmweb.com)

Flatness  
Aplatissement

Max 3.0mm

Projection

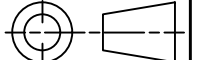

Customer Client	Date
Drawn By Dessiné Par BoxCad: BoxCad	Date 2022-09-26
Material Matière 14 Ga Stainless Steel 304 (1.7mm)	
Color Couleur Unpainted	Finish Fini Brushed
Description 1412BTSS 1000A - 4Wires x 144" Assembly	Detail Rev.
Part Number Numéro Pièce 1412BTSS121004	Rev. 0

SEE BILL OF MATERIAL ON LAST PAGE

This drawing is confidential and must not be reproduced or used without the consent of Eurobox

Ce dessin est confidentiel et ne doit pas être reproduit ou utilisé sans le consentement de Eurobox

**STANDARD FEATURES ARE NOT LISTED IN THIS HOLE TABLE**

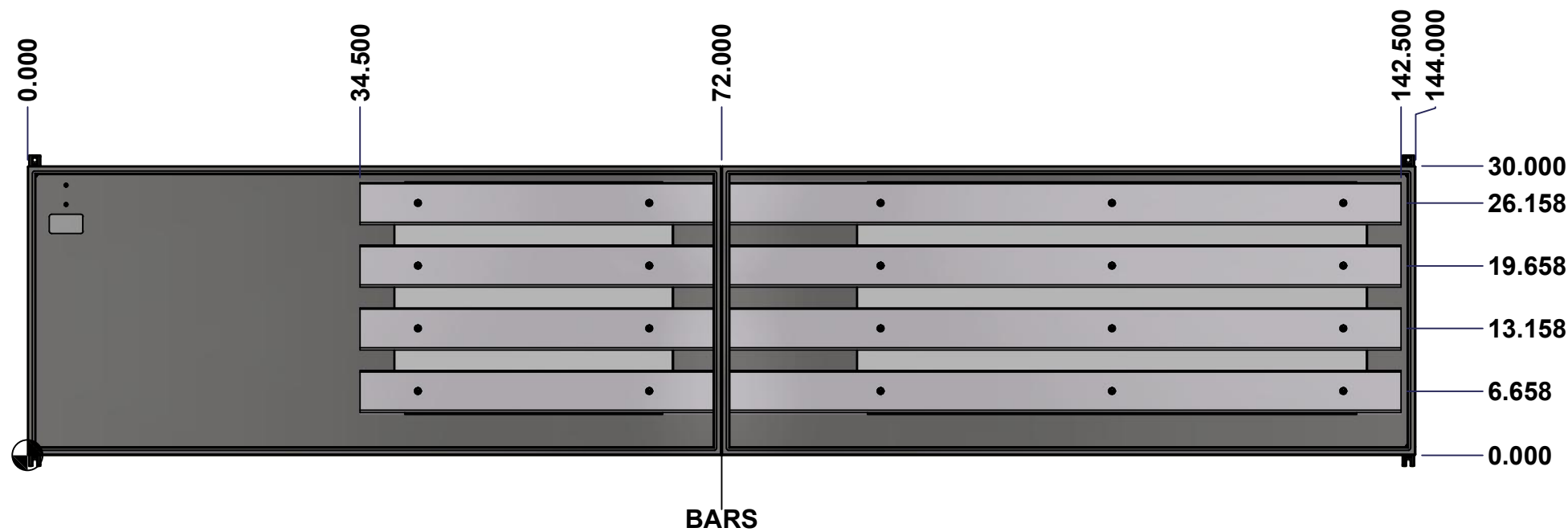

	Description 1412BTSS 1000A - 4Wires x 144" Assembly		Status (NULL)
	Part Number Numéro Pièce <b>1412BTSS121004</b>		Rev. 2 <b>0</b>

This drawing is confidential and must not be reproduced or used without the consent of EXM

Ce dessin est confidentiel et ne doit pas être reproduit ou utilisé sans le consentement de EXM

NOTE	
ITEM	DESCRIPTION
1	NEMA 4X Enclosure
2	C/W Standard ground studs on box and cover
3	W/O Standard door stiffener
4	C/W Special inner panel (Sold separately)
5	C/W Standard inner panel mounting studs

No.	Revisions	Date	By/Par

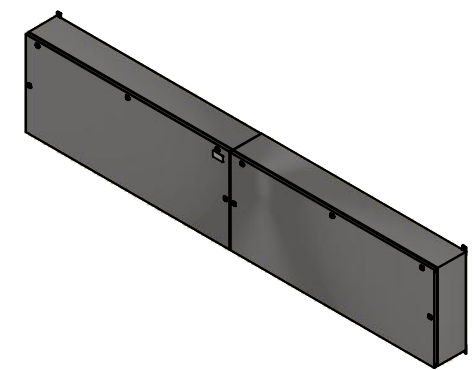

Isometric View



PACKING		
ITEM	QTY	DESCRIPTION
Cardboard sleeve	2	Top and Bottom
Cardboard strip	2	Between back of enclosure and inner panel
Plastic bag	1	To protect cover surface and inside gasket
Cardboard corner	4	To reinforced for the plastic strap tightening
Plastic strap - Black	2	To Squeeze 2 cardboard sleeve together
Packaging label	3	White label with PN
Plastic strap- Green	2	To secure the enclosure to the wood pallet
Wood Pallet	1	2" deeper and 3" larger than enclosure size

8	STK-Q-04051-07	8	M6 x 7mm Stainless Steel Hexagon Socket Head Machine Screw with Nyseal
1	885 ESMF2	0	885 ESMF2 Stainless Steel Mounting Feet Kit
1	1412BTSS121004IP2	0	1412BTSS 24.125" x 53" Right Inner Panel
1	1412BTSS121004BAR1-P	0	Rounded Edge Aluminum Bar 3/8" x 4 1/2"
1	1412BTSS121004BAR2-P	0	Rounded Edge Aluminum Bar 3/8" x 4 1/2"
1	1412BTSS121004BAR3-P	0	Rounded Edge Aluminum Bar 3/8" x 4 1/2"
1	1412BTSS121004BAR4-P	0	Rounded Edge Aluminum Bar 3/8" x 4 1/2"
1	1412BTSS121004IP1	0	1412BTSS 24.125" x 29" Left Inner Panel
20	STK-A-67400	0	Buss Bar Insulator Kit
1	STK-K-01800	5	5412 ES Accessory Kit
30	STK-Q-07310	2	Flange Lock Nut M8
10	STK-Q-07610	8	M8 Plastic Spacer 22.2mm
1	1412BTSS121004B	0	1412BTSS 30" x 144" x 10" Body
1	1412BTSS121004C	0	1412BTSS 30" x 144" Cover
Qty	Part Number	Rev	Description
Parts List			



Tél: (450) 979-4373  
Fax: (450) 979-4626  
[www.exmweb.com](http://www.exmweb.com)

Flatness  
Aplatissement  
Max 3.0mm

Projection

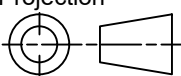

Customer Client	Date
Drawn By Dessiné Par	Date 2022-09-26
Material Matière	14 Ga Stainless Steel 304 (1.7mm)
Color Couleur	Unpainted Finish Finis
Description	Detail Rev.
1412BTSS 1000A - 4Wires x 144" Assembly	
Part Number Numéro Pièce	Rev. 3
<b>1412BTSS121004</b>	<b>0</b>

This drawing is confidential and must not be reproduced or used without the consent of EXM

Ce dessin est confidentiel et ne doit pas être reproduit ou utilisé sans le consentement de EXM

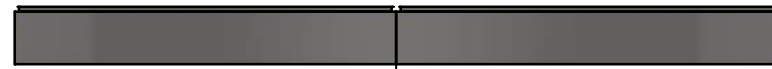

TOP

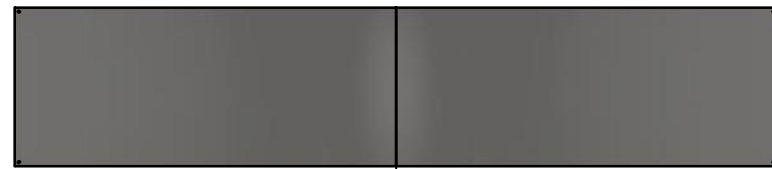

BACK

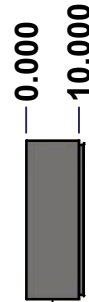

LEFT



FRONT

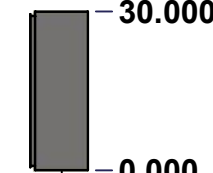

RIGHT



BOTTOM

No.	Revisions	Date	By/Par

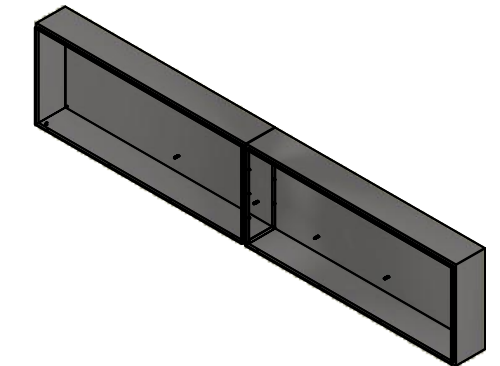

Isometric View



Tél: (450) 979-4373  
 Fax: (450) 979-4626  
[www.exmweb.com](http://www.exmweb.com)

Flatness  
Aplatissement

Max 3.0mm

Projection

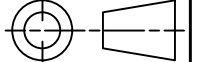

Customer Client	Date
Drawn By Dessiné Par BoxCad: BoxCad	Date 2022-09-26
Material Matière 14 Ga Stainless Steel 304 (1.7mm)	
Color Couleur Unpainted	Finish Fini Brushed
Description 1412BTSS 30" x 144" x 10" Body	Detail Rev.
Part Number Numéro Pièce <b>1412BTSS121004B</b>	Rev. <b>0</b>

SEE BILL OF MATERIAL ON LAST PAGE

This drawing is confidential and must not be reproduced or used without the consent of Eurobox

Ce dessin est confidentiel et ne doit pas être reproduit ou utilisé sans le consentement de Eurobox

**STANDARD FEATURES ARE NOT LISTED IN THIS HOLE TABLE**

**HOLE TABLE - BACK VIEW (CUSTOM FEATURE ONLY)**

CUT-OUT	XDIM	YDIM	DESCRIPTION
1	140.000	28.000	GND STUD M8 x 35mm (Inside)
2	140.000	26.000	GND STUD M8 x 35mm (Inside)
3	5.875	27.500	IP STUD M8 x 35mm (Inside)
4	57.125	27.500	IP STUD M8 x 35mm (Inside)
5	5.875	5.125	IP STUD M8 x 35mm (Inside)
6	57.125	5.125	IP STUD M8 x 35mm (Inside)
7	77.875	27.500	IP STUD M8 x 35mm (Inside)
8	105.125	27.500	IP STUD M8 x 35mm (Inside)
9	77.875	5.125	IP STUD M8 x 35mm (Inside)
10	105.125	5.125	IP STUD M8 x 35mm (Inside)
11	33.125	27.500	IP STUD M8 x 35mm (Inside)
12	33.125	5.125	IP STUD M8 x 35mm (Inside)

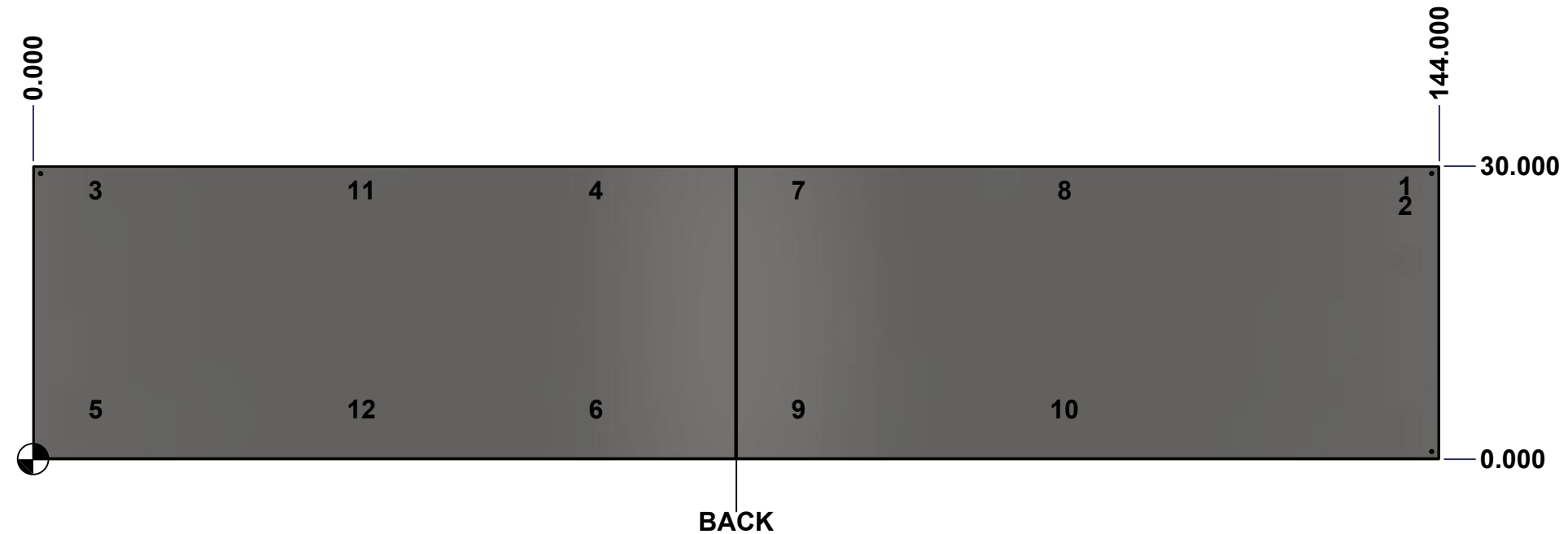

	Description	Status
	1412BTSS 30" x 144" x 10" Body	(NULL)
	Part Number Numéro Pièce	Rev.
	<b>1412BTSS121004B</b>	<b>0</b> / 5
		13

This drawing is confidential and must not be reproduced or used without the consent of EXM

Ce dessin est confidentiel et ne doit pas être reproduit ou utilisé sans le consentement de EXM

No.	Revisions	Date	By/Par

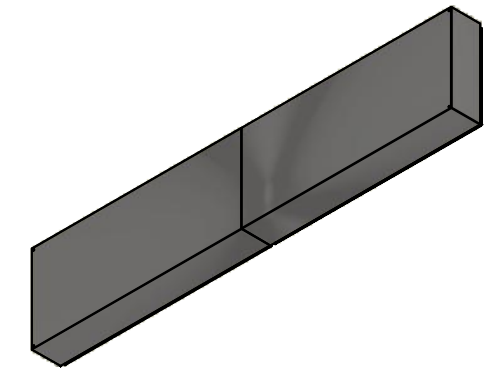

Isometric View



Tél: (450) 979-4373  
 Fax: (450) 979-4626  
[www.exmweb.com](http://www.exmweb.com)

Flatness  
Aplatissement

Max 3.0mm

Projection



Customer Client	Date
Drawn By / Dessiné Par: BoxCad: BoxCad	Date: 2022-09-26

Material / Matière: 14 Ga Stainless Steel 304 (1.7mm)

Color / Couleur: Unpainted	Finish / Fini: Brushed
----------------------------	------------------------

Description: 1412BTSS 30" x 144" x 10" Body

Part Number / Numéro Pièce: <b>1412BTSS121004B</b>	Rev. 0	6
--	--------	---

Qty	Part Number	Rev	Description
1	1412BTSS121004B-P	0	1412BTSS 30" x 144" x 10" Left Body Part
1	1412BTSS121004E-P	0	1412BTSS 30" x 144" x 10" Right Body Part
1	STK-G-00701	0	1" x 1/4" Self-Adhesive Neoprene Gasket
10	STK-Q-00260	1	M6 x 13mm Carriage Bolt
10	STK-Q-07220	1	M6 Nylon Insert Lock Nut
12	STK-Q-16020	1	Stud M8 x 35mm Stainless Steel
2	STK-Q-16095	0	M6 x 16mm Stainless Steel Ground Stud
1	STK-S-00100	0	3.5" x 2" Silver Milar Flexcon Sticker
Parts List			

This drawing is confidential and must not be reproduced or used without the consent of EXM

Ce dessin est confidentiel et ne doit pas être reproduit ou utilisé sans le consentement de EXM

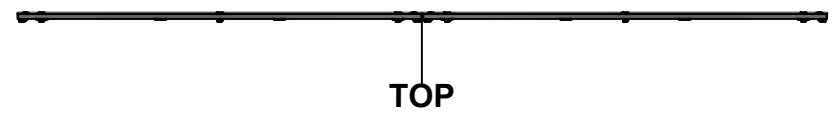

TOP

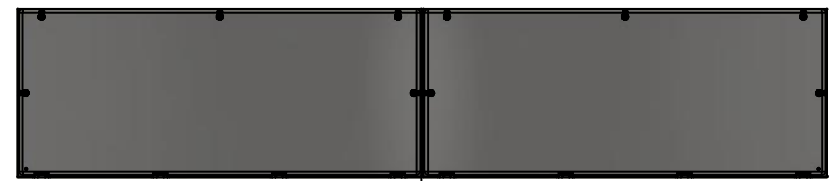

BACK



LEFT

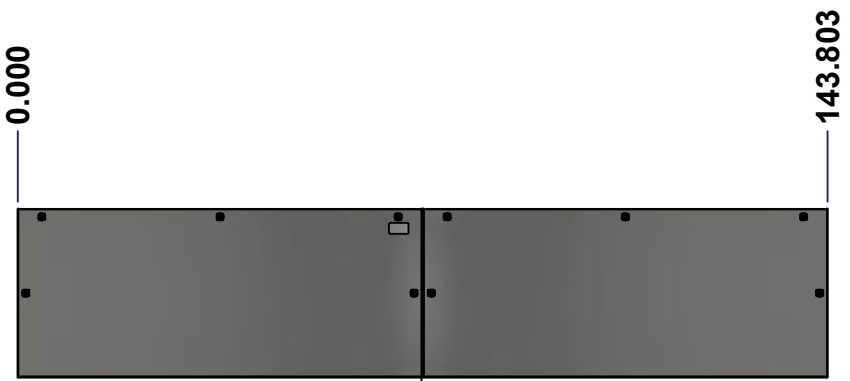

FRONT

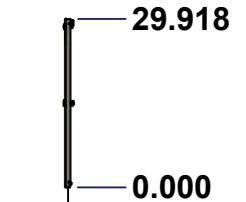

RIGHT



BOTTOM

No.	Revisions	Date	By/Par

Isometric View

Tél: (450) 979-4373 Fax: (450) 979-4626 <a href="http://www.exmweb.com">www.exmweb.com</a>		Flatness Aplatissement
		Max 3.0mm
Customer Client		Date
Drawn By Dessiné Par BoxCad: BoxCad		Date 2022-09-26
Material Matière 14 Ga Stainless Steel 304 (1.7mm)		
Color Couleur Unpainted	Finish Fini Brushed	
Description 1412BTSS 30" x 144" Cover		Detail Rev.
Part Number Numéro Pièce <b>1412BTSS121004C</b>		Rev. <b>0</b>

SEE BILL OF MATERIAL ON LAST PAGE

This drawing is confidential and must not be reproduced or used without the consent of Eurobox

Ce dessin est confidentiel et ne doit pas être reproduit ou utilisé sans le consentement de Eurobox

**STANDARD FEATURES ARE NOT LISTED IN THIS HOLE TABLE**

**HOLE TABLE - FRONT VIEW (CUSTOM FEATURE ONLY)**

CUT-OUT	XDIM	YDIM	DESCRIPTION
1	1.500	1.486	GND STUD M6 x 16mm (Inside)
2	142.303	1.486	GND STUD M6 x 16mm (Inside)
3	139.553	28.494	LOCK 880 SCQ4-SLSS6 @ 90.0°
4	142.379	14.959	LOCK 880 SCQ4-SLSS6 @ 0.0°
5	73.424	14.959	LOCK 880 SCQ4-SLSS6 @ 180.0°
6	70.379	14.959	LOCK 880 SCQ4-SLSS6 @ 0.0°
7	1.424	14.959	LOCK 880 SCQ4-SLSS6 @ 180.0°
8	107.902	28.494	LOCK 880 SCQ4-SLSS6 @ 90.0°
9	76.250	28.494	LOCK 880 SCQ4-SLSS6 @ 90.0°
10	67.553	28.494	LOCK 880 SCQ4-SLSS6 @ 90.0°
11	35.902	28.494	LOCK 880 SCQ4-SLSS6 @ 90.0°
12	4.250	28.494	LOCK 880 SCQ4-SLSS6 @ 90.0°

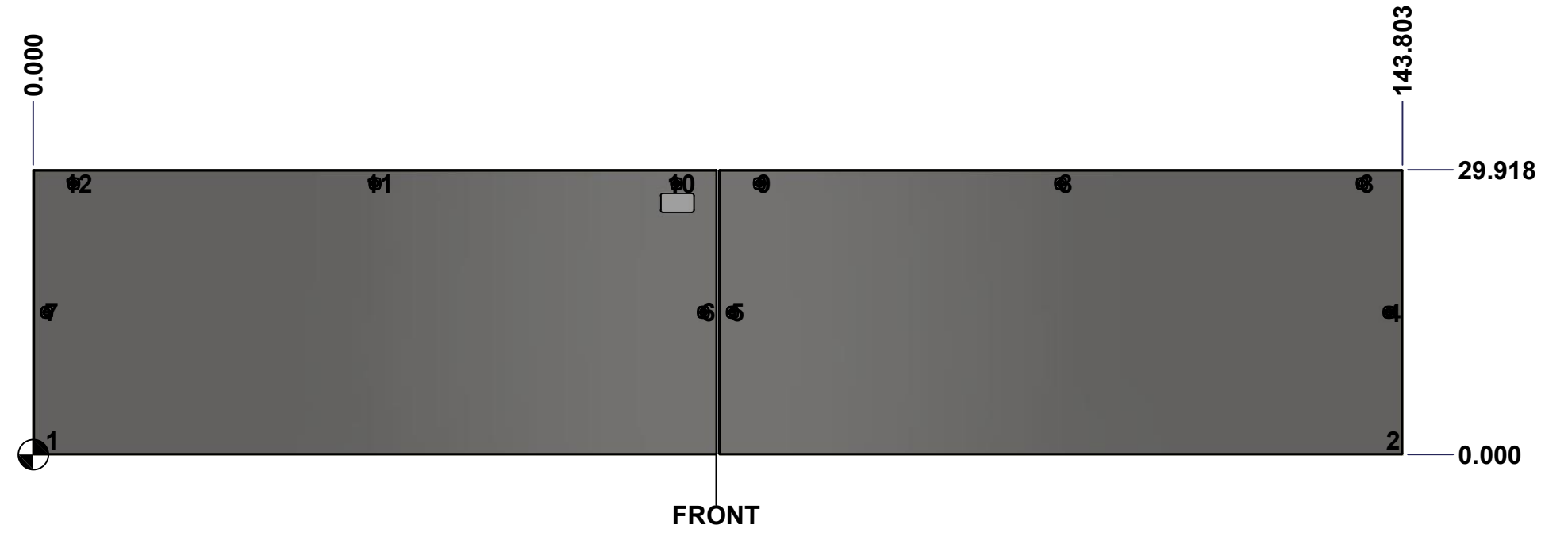

	Description	Status	
	1412BTSS 30" x 144" Cover	(NULL)	
	Part Number Numéro Pièce	Rev.	8
	<b>1412BTSS121004C</b>	<b>0</b>	13



This drawing is confidential and must not be reproduced or used without the consent of EXM

Ce dessin est confidentiel et ne doit pas être reproduit ou utilisé sans le consentement de EXM

No.	Revisions	Date	By/Par

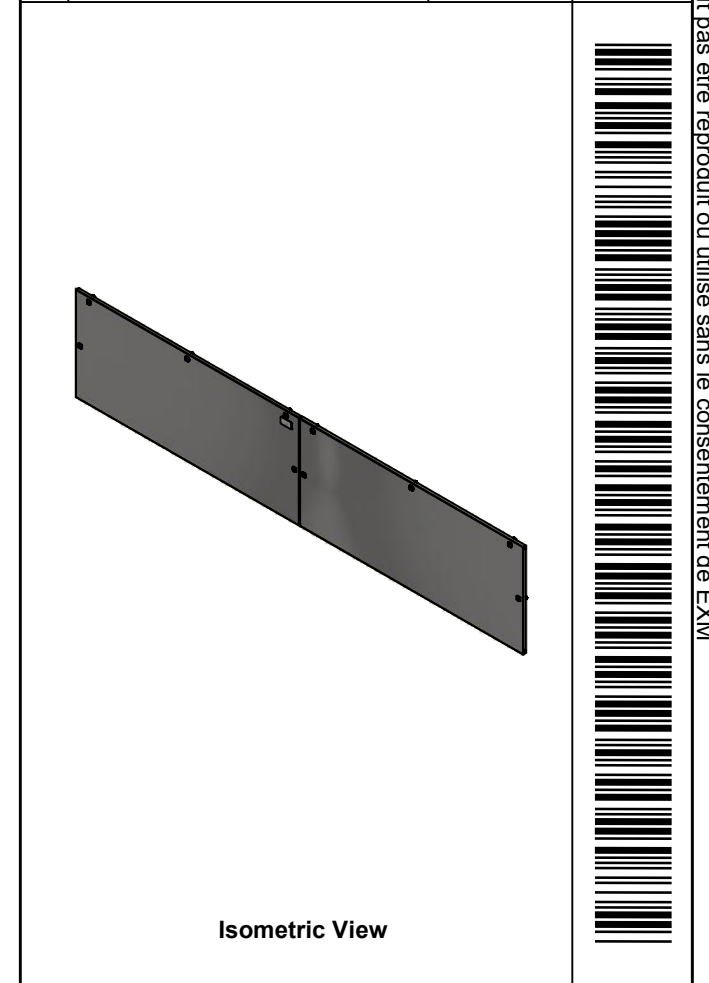

 Tél: (450) 979-4373 Fax: (450) 979-4626 <a href="http://www.exmweb.com">www.exmweb.com</a>	Flatness Aplatissement
	Max 3.0mm
Projection	

Customer Client	Date
Drawn By / Dessiné Par: BoxCad: BoxCad	Date: 2022-09-26

Material / Matière: 14 Ga Stainless Steel 304 (1.7mm)

Color / Couleur: Unpainted	Finish / Fini: Brushed
----------------------------	------------------------

Description: 1412BTSS 30" x 144" Cover	Detail Rev.
--	-------------

Part Number / Numéro Pièce: <b>1412BTSS121004C</b>	Rev. <b>0</b>	9
--	---------------	---

Qty	Part Name	Rev	Description
2	1412BTSS121004G	0	1412BTSS 30" x 144" Cover Gasket
8	STK-K-09850	6	5412 ESS Hinge with 2 Captive Hinge Pins
2	STK-Q-16095	0	M6 x 16mm Stainless Steel Ground Stud
1	STK-S-00100	0	3.5" x 2" Silver Milar Flexcon Sticker
1	1412BTSS121004C-P	0	1412BTSS 30" x 72" Left Cover Part
1	1412BTSS121004F-P	0	1412BTSS 30" x 144" Right Cover Part
10	880 SCQ4-SLSS6	7	5412 ESS 1/4 Turn Lock
Parts List			

This drawing is confidential and must not be reproduced or used without the consent of EXM

Ce dessin est confidentiel et ne doit pas être reproduit ou utilisé sans le consentement de EXM

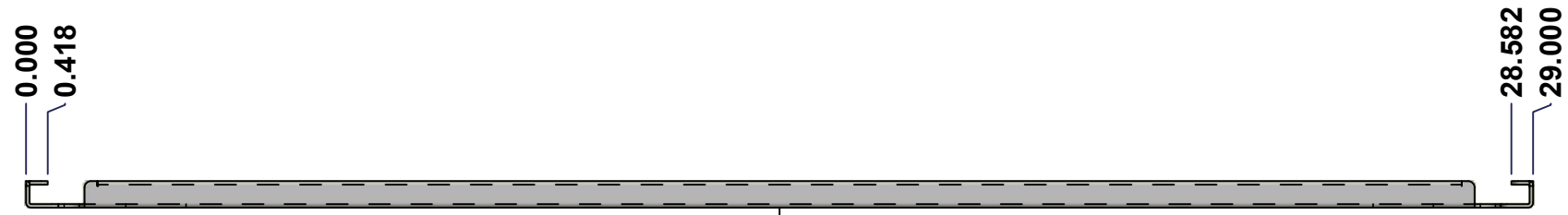

TOP

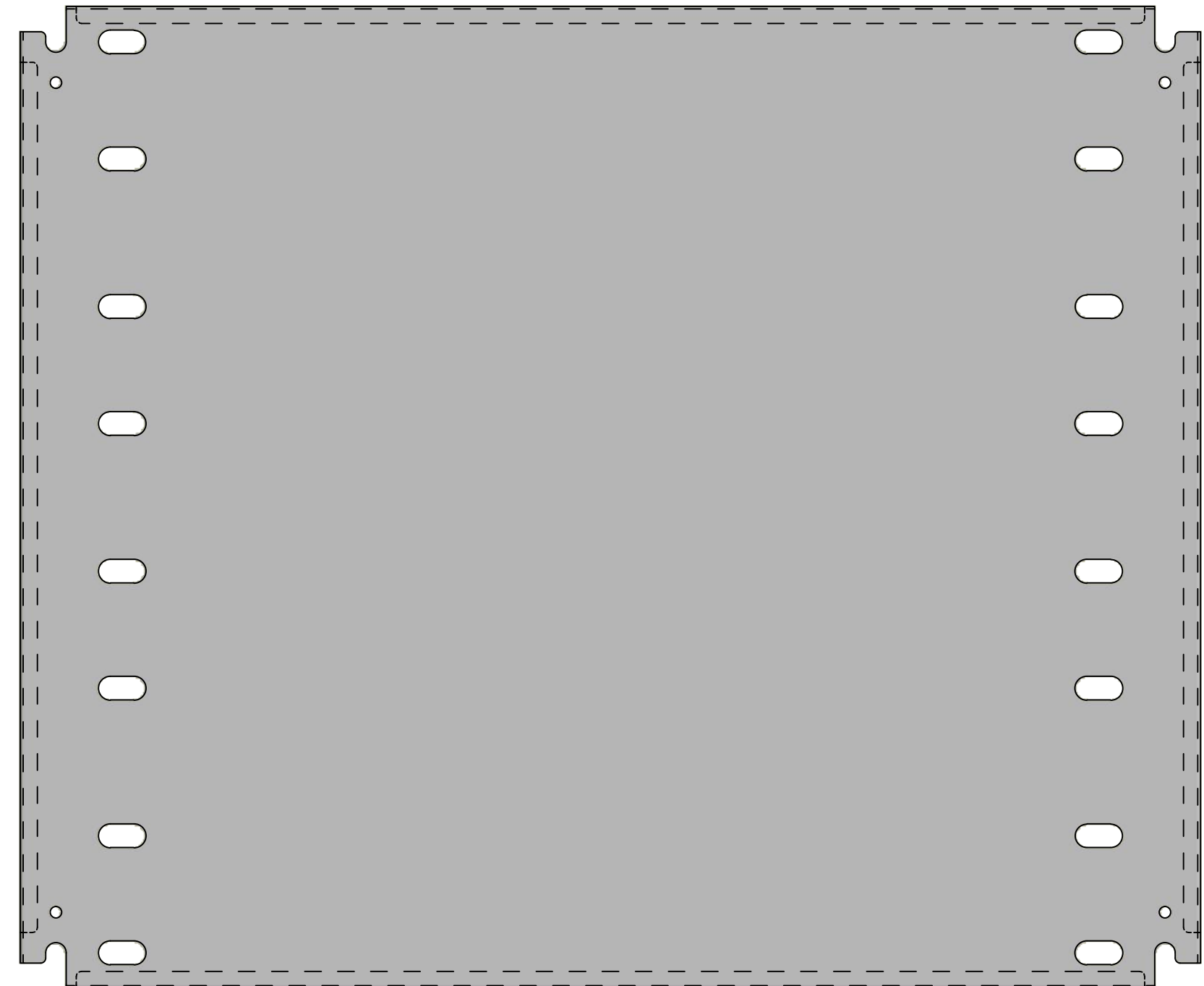

FRONT

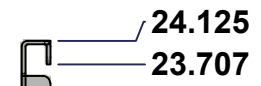

RIGHT

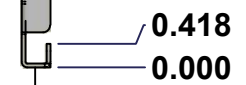

No.	Revisions	Date	By/Par

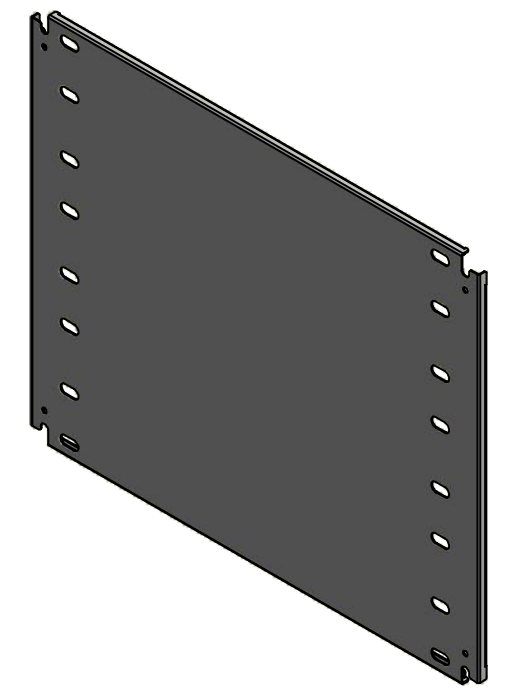

Isometric View



Tél: (450) 979-4373  
Fax: (450) 979-4626  
[www.exmweb.com](http://www.exmweb.com)

Flatness  
Aplatissement  
Max 3.0mm  
Projection

Customer Client	Date
Drawn By Dessiné Par BoxCad: BoxCad	Date 2022-09-26
Material Matière 14 Ga Cold Rolled A1008 CS Type B (1.7mm)	

Color Couleur White RAL9003	Finish Fini Smooth
--------------------------------	-----------------------

Description 1412BTSS 24.125" x 29" Left Inner Panel	Detail Rev.
--	-------------

Part Number Numéro Pièce <b>1412BTSS121004IP1</b>	Rev. <b>0</b>	10 13
---	------------------	----------

SEE BILL OF MATERIAL ON LAST PAGE

This drawing is confidential and must not be reproduced or used without the consent of EXM

Ce dessin est confidentiel et ne doit pas être reproduit ou utilisé sans le consentement de EXM

No.	Revisions	Date	By/Par

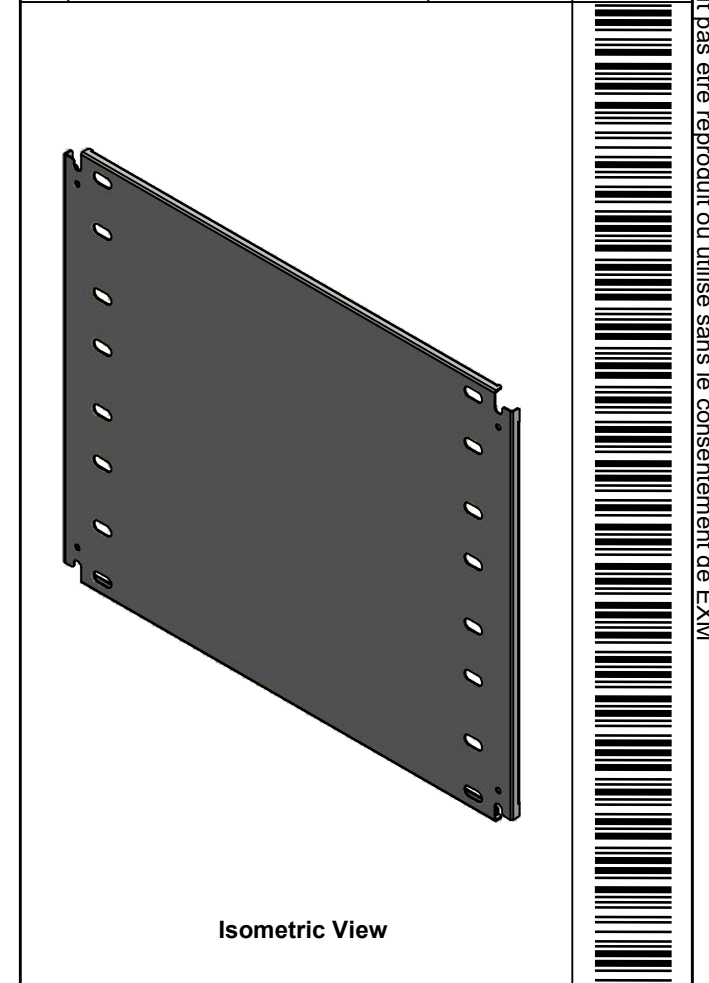

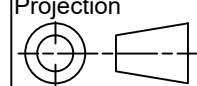
 Tél: (450) 979-4373 Fax: (450) 979-4626 <a href="http://www.exmweb.com">www.exmweb.com</a>		Flatness Aplatissement Max 3.0mm
Customer Client		Projection 
Drawn By / Dessiné Par: BoxCad: BoxCad		Date: 2022-09-26
Material / Matière: 14 Ga Cold Rolled A1008 CS Type B (1.7mm)		
Color / Couleur: White RAL9003	Finish / Fini: Smooth	
Description: 1412BTSS 24.125" x 29" Left Inner Panel		Detail Rev.
Part Number / Numéro Pièce: <b>1412BTSS121004IP1</b>		Rev. 11 <b>0</b>

Qty	Part Number	Rev	Description
1	STK-P-02401S	0	Powder Paint (White / Smooth)
1	1412BTSS121004IP1-P	0	1412BTSS 24.125" x 144" Left Inner Panel Part
Parts List			

This drawing is confidential and must not be reproduced or used without the consent of EXM

Ce dessin est confidentiel et ne doit pas être reproduit ou utilisé sans le consentement de EXM



TOP

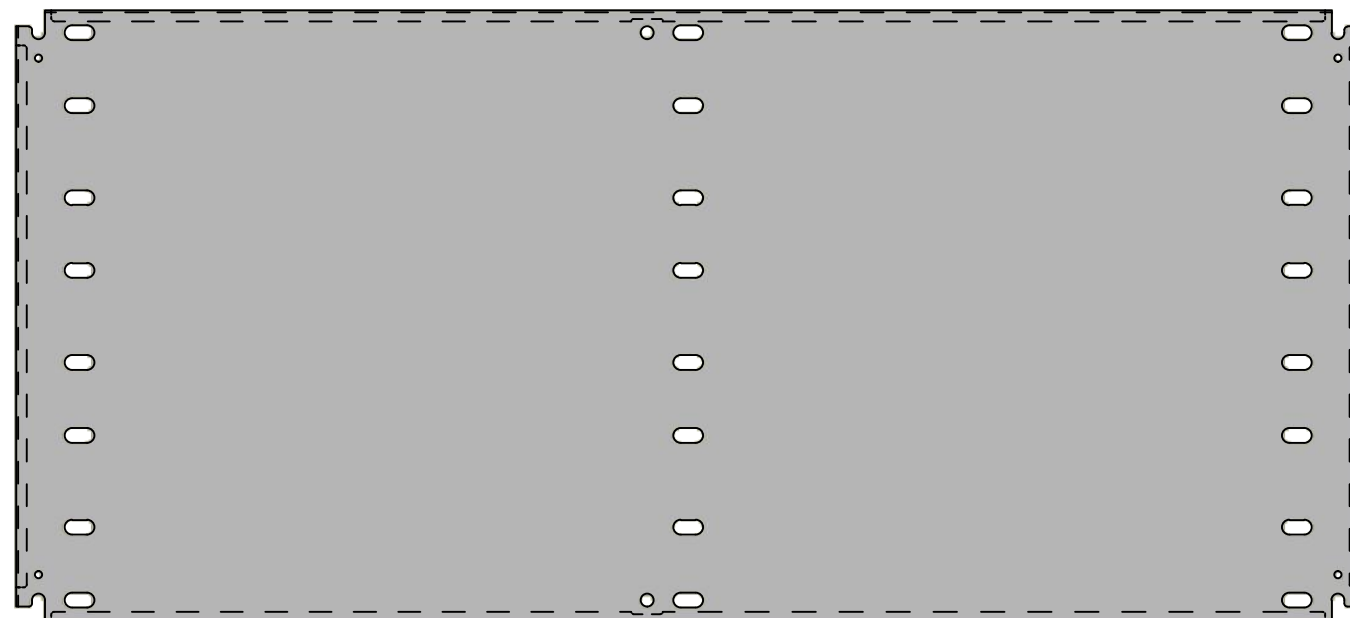

FRONT

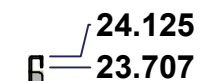

RIGHT

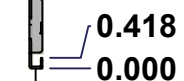

No.	Revisions	Date	By/Par

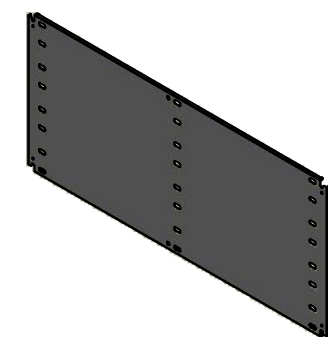

Isometric View

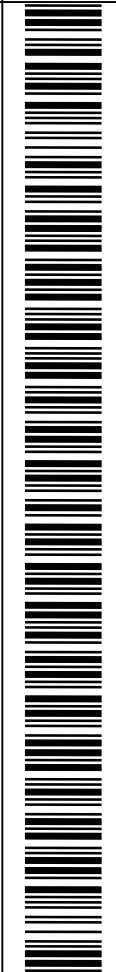

Tél: (450) 979-4373  
 Fax: (450) 979-4626  
[www.exmweb.com](http://www.exmweb.com)

Flatness  
Aplatissement  
Max 3.0mm  
Projection

Customer Client	Date
Drawn By / Dessiné Par: BoxCad: BoxCad	Date: 2022-09-26
Material / Matière: 14 Ga Cold Rolled A1008 CS Type B (1.7mm)	
Color / Couleur: White RAL9003	Finish / Fini: Smooth
Description: 1412BTSS 24.125" x 53" Right Inner Panel	Detail Rev.
Part Number / Numéro Pièce: 1412BTSS121004IP2	Rev. 0

SEE BILL OF MATERIAL ON LAST PAGE

This drawing is confidential and must not be reproduced or used without the consent of EXM

Ce dessin est confidentiel et ne doit pas être reproduit ou utilisé sans le consentement de EXM

No.	Revisions	Date	By/Par

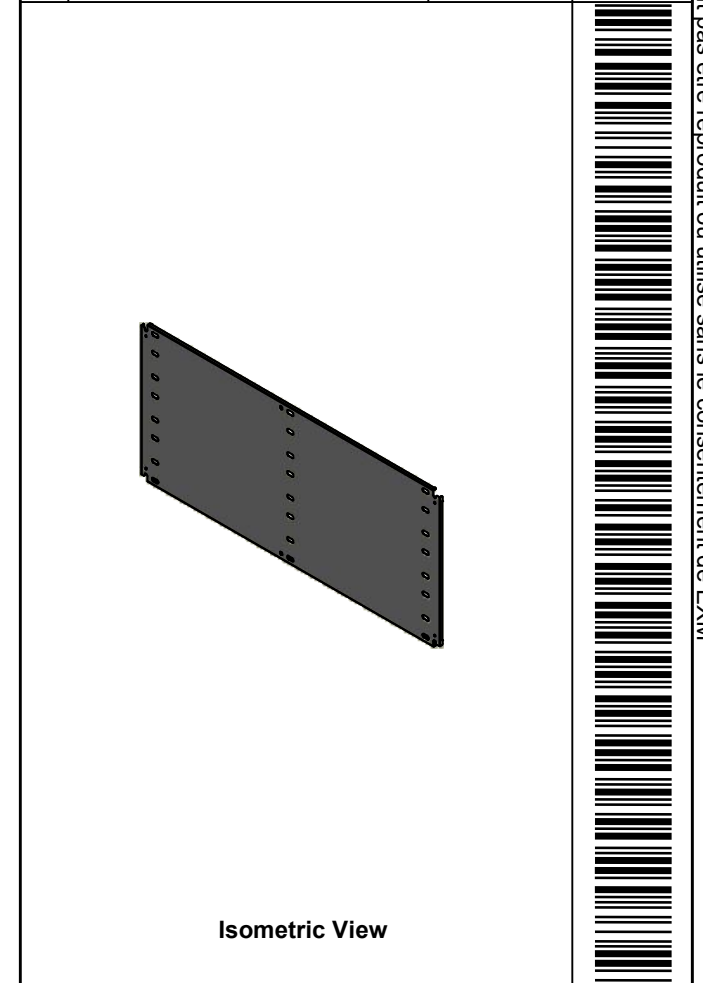

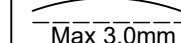
 Tél: (450) 979-4373 Fax: (450) 979-4626 <a href="http://www.exmweb.com">www.exmweb.com</a>		Flatness Aplatissement  Max 3.0mm
Customer Client		Date
Drawn By / Dessiné Par: BoxCad: BoxCad		Date: 2022-09-26
Material / Matière: 14 Ga Cold Rolled A1008 CS Type B (1.7mm)		
Color / Couleur: White RAL9003	Finish / Fini: Smooth	
Description: 1412BTSS 24.125" x 53" Right Inner Panel		Detail Rev.
Part Number / Numéro Pièce: <b>1412BTSS121004IP2</b>		Rev. 0 / 13

Qty	Part Number	Rev	Description
1	STK-P-02401S	0	Powder Paint (White / Smooth)
1	1412BTSS121004IP2-P	0	1412BTSS 24.125" x 144" Right Inner Panel Part
Parts List			