

This drawing is confidential and must not be reproduced or used without the consent of EXM

Ce dessin est confidentiel et ne doit pas être reproduit ou utilisé sans le consentement de EXM

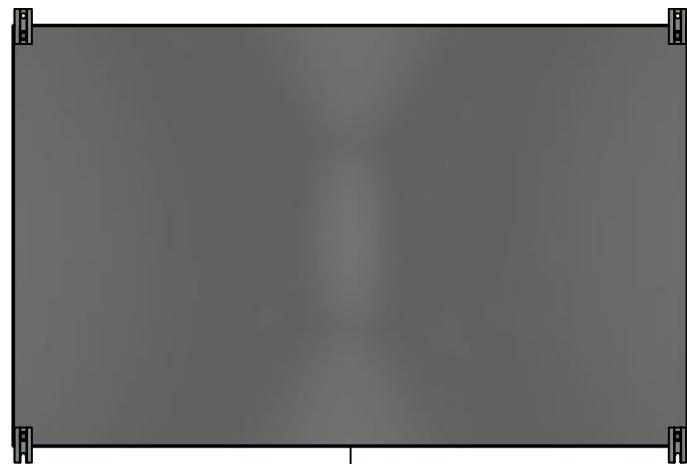

TOP



BACK



LEFT

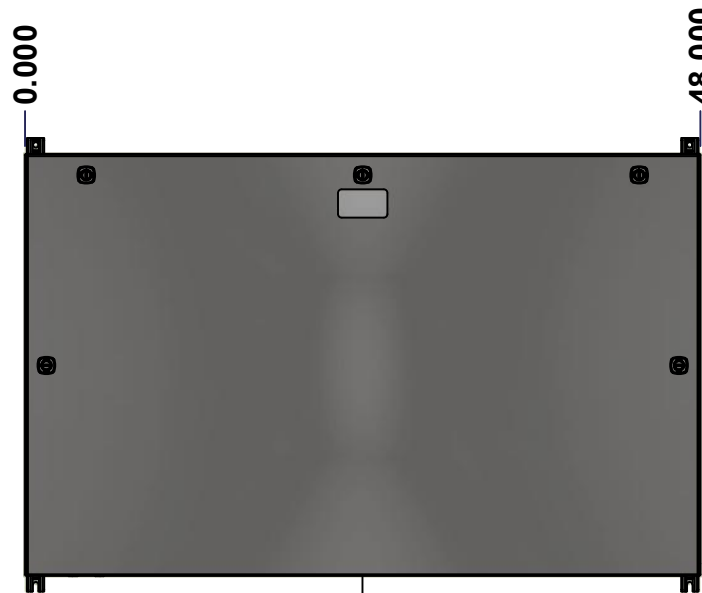

FRONT



RIGHT



BOTTOM

| No. | Revisions | Date | By/Par |
|-----|-----------|------|--------|
|     |           |      |        |
|     |           |      |        |
|     |           |      |        |
|     |           |      |        |
|     |           |      |        |

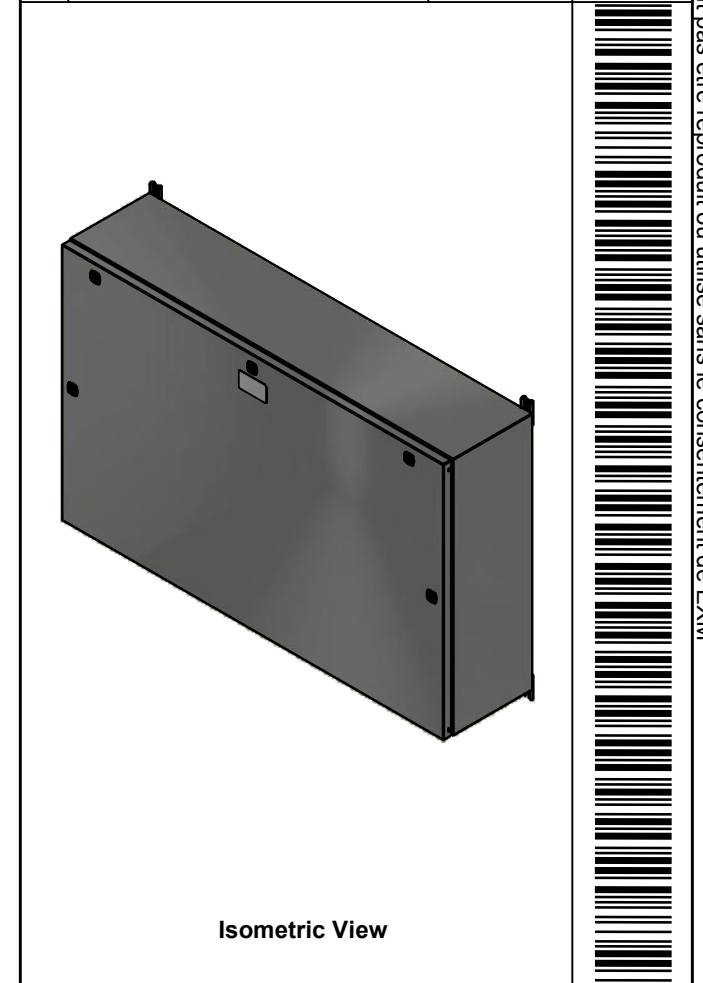

Isometric View

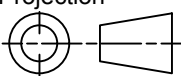
|                                                                                                                                                                                        |                                   |                                                                                       |
|----------------------------------------------------------------------------------------------------------------------------------------------------------------------------------------|-----------------------------------|---------------------------------------------------------------------------------------|
|  Tél: (450) 979-4373<br>Fax: (450) 979-4626<br><a href="http://www.exmweb.com">www.exmweb.com</a> | Flatness<br>Aplatissement         | Max 3.0mm                                                                             |
|                                                                                                                                                                                        | Projection                        |  |
| Customer<br>Client                                                                                                                                                                     | Date                              |                                                                                       |
| Drawn By<br>Dessiné Par                                                                                                                                                                | BoxCad: BoxCad                    | Date 03-Nov-22                                                                        |
| Material<br>Matière                                                                                                                                                                    | 14 Ga Stainless Steel 304 (1.7mm) |                                                                                       |
| Color<br>Couleur                                                                                                                                                                       | Unpainted                         | Finish<br>Fini Brushed                                                                |
| Description                                                                                                                                                                            | Detail Rev.                       |                                                                                       |
| 1412BTSSCU 800A - 4Wires x 48"<br>Assembly                                                                                                                                             |                                   |                                                                                       |
| Part Number<br>Numéro Pièce                                                                                                                                                            | Rev.                              | 1                                                                                     |
| 1412BTSSCU04804DT                                                                                                                                                                      | 0                                 | 15                                                                                    |

SEE BILL OF MATERIAL ON LAST PAGE

This drawing is confidential and must not be reproduced or used without the consent of Eurobox

Ce dessin est confidentiel et ne doit pas être reproduit ou utilisé sans le consentement de Eurobox

**STANDARD FEATURES ARE NOT LISTED IN THIS HOLE TABLE**

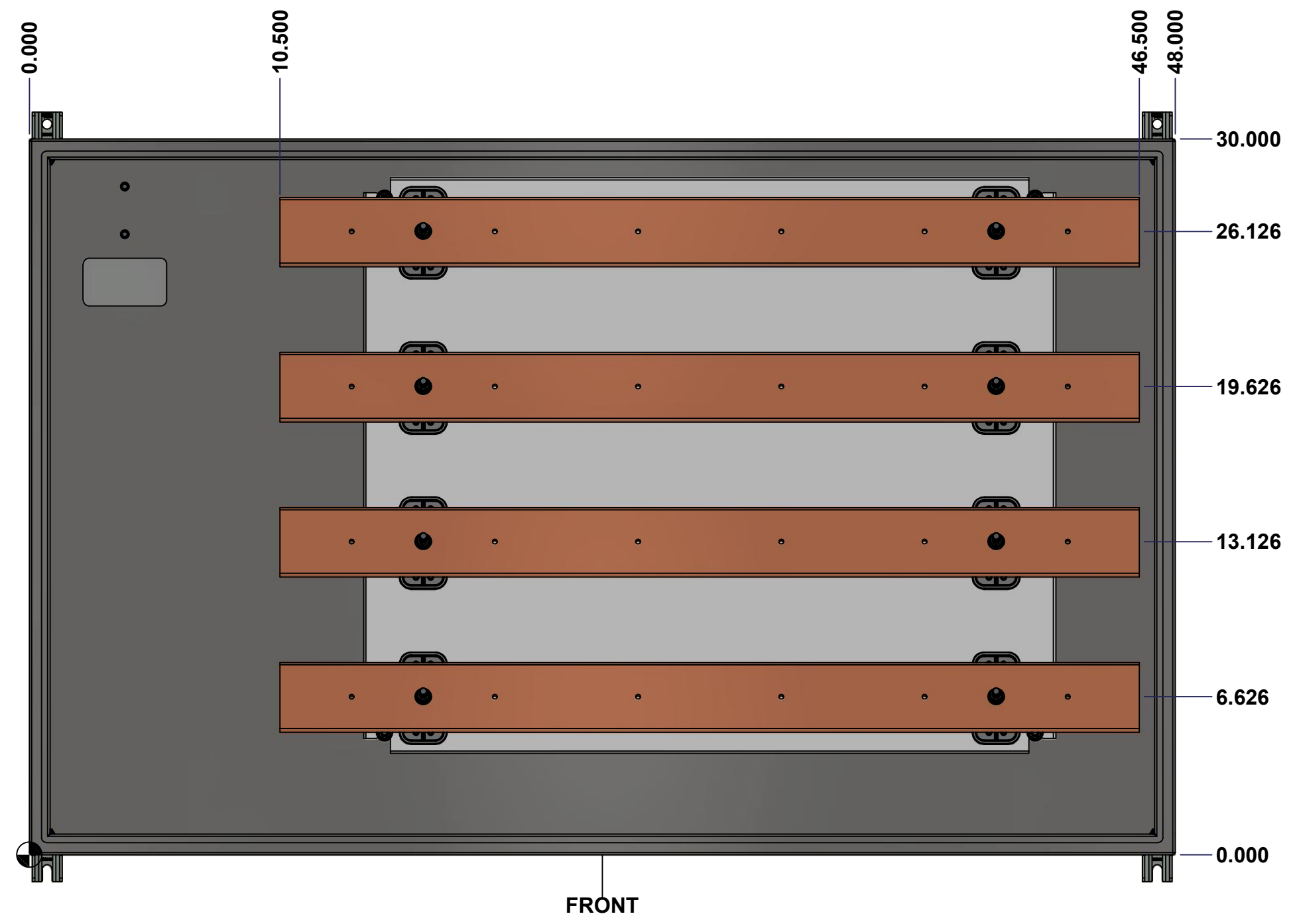

|  |                                                           |  |                  |         |
|--|-----------------------------------------------------------|--|------------------|---------|
|  | Description<br>1412BTSSCU 800A - 4Wires x 48"<br>Assembly |  | Status<br>(NULL) |         |
|  | Part Number<br>Numéro Pièce<br><b>1412BTSSCU04804DT</b>   |  | Rev.<br><b>0</b> | 2<br>15 |

This drawing is confidential and must not be reproduced or used without the consent of EXM

Ce dessin est confidentiel et ne doit pas être reproduit ou utilisé sans le consentement de EXM

| NOTE |                                            |
|------|--------------------------------------------|
| ITEM | DESCRIPTION                                |
| 1    | NEMA 4X Enclosure                          |
| 2    | C/W Standard ground studs on box and cover |
| 3    | W/O Standard door stiffener                |
| 4    | C/W Special inner panel (Sold separately)  |
| 5    | C/W Standard inner panel mounting studs    |

| No. | Revisions | Date | By/Par |
|-----|-----------|------|--------|
|     |           |      |        |
|     |           |      |        |
|     |           |      |        |
|     |           |      |        |
|     |           |      |        |
|     |           |      |        |

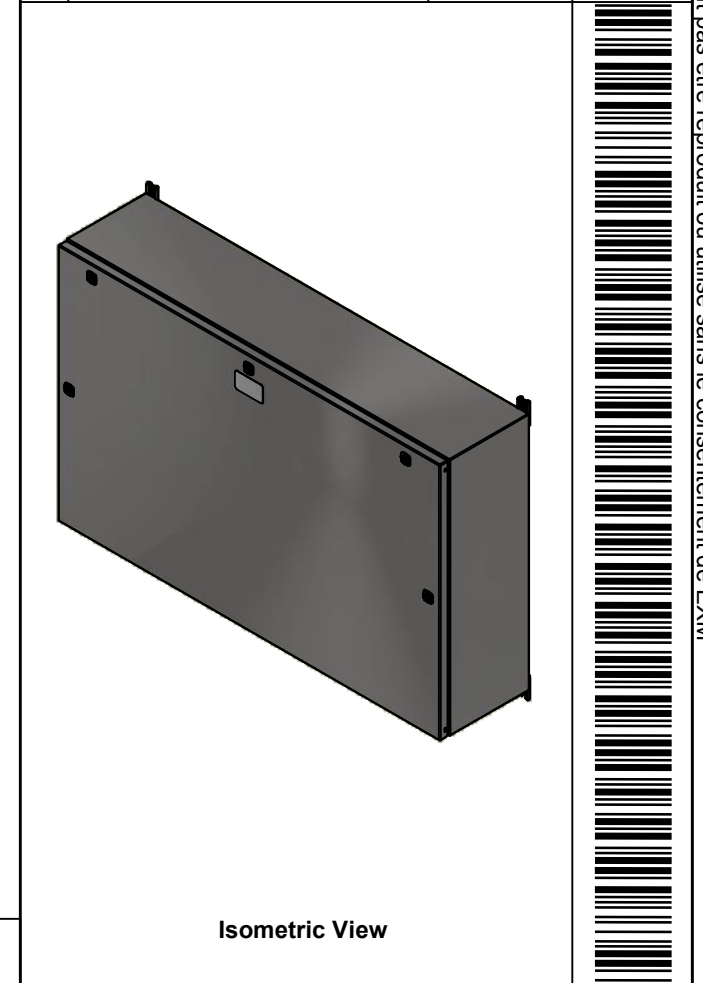

Isometric View

| PACKING               |     |                                                |
|-----------------------|-----|------------------------------------------------|
| ITEM                  | QTY | DESCRIPTION                                    |
| Cardboard sleeve      | 2   | Top and Bottom                                 |
| Cardboard strip       | 2   | Between back of enclosure and inner panel      |
| Plastic bag           | 1   | To protect cover surface and inside gasket     |
| Cardboard corner      | 4   | To reinforced for the plastic strap tightening |
| Plastic strap - Black | 2   | To Squeeze 2 cardboard sleeve together         |
| Packaging label       | 3   | White label with PN                            |
| Plastic strap- Green  | 2   | To secure the enclosure to the wood pallet     |
| Wood Pallet           | 1   | 2" deeper and 3" larger than enclosure size    |

|            |                          |     |                                                                        |
|------------|--------------------------|-----|------------------------------------------------------------------------|
| 4          | STK-Q-04051-07           | 8   | M6 x 7mm Stainless Steel Hexagon Socket Head Machine Screw with Nyseal |
| 1          | 885 ESMF2                | 0   | 885 ESMF2 Stainless Steel Mounting Feet Kit                            |
| 1          | 1412BTSSCU04804DTBA R4-P | 0   | Rounded Edge Copper Bar 1/4" x 3"                                      |
| 1          | 1412BTSSCU04804DTBA R1-P | 0   | Rounded Edge Copper Bar 1/4" x 3"                                      |
| 1          | 1412BTSSCU04804DTBA R2-P | 0   | Rounded Edge Copper Bar 1/4" x 3"                                      |
| 1          | 1412BTSSCU04804DTBA R3-P | 0   | Rounded Edge Copper Bar 1/4" x 3"                                      |
| 1          | 1412BTSSCU04804DTIP1     | 0   | 1412BTSSCU 24.125" x 29" Inner Panel                                   |
| 8          | STK-A-67400              | 0   | Buss Bar Insulator Kit                                                 |
| 1          | STK-K-01800              | 5   | 5412 ES Accessory Kit                                                  |
| 12         | STK-Q-07310              | 2   | Flange Lock Nut M8                                                     |
| 4          | STK-Q-07610              | 8   | M8 Plastic Spacer 22.2mm                                               |
| 1          | 1412BTSSCU04804DTB       | 0   | 1412BTSSCU 30" x 48" x 10" Body                                        |
| 1          | 1412BTSSCU04804DTC       | 0   | 1412BTSSCU 30" x 48" Cover                                             |
| Qty        | Part Number              | Rev | Description                                                            |
| Parts List |                          |     |                                                                        |

|                                                         |                                                                                                  |                                        |
|---------------------------------------------------------|--------------------------------------------------------------------------------------------------|----------------------------------------|
|                                                         | Tél: (450) 979-4373<br>Fax: (450) 979-4626<br><a href="http://www.exmweb.com">www.exmweb.com</a> | Flatness<br>Aplatissement<br>Max 3.0mm |
|                                                         | Projection<br>                                                                                   | Customer Client<br>Date                |
| Drawn By<br>Dessiné Par<br>Material<br>Matière          | BoxCad: BoxCad<br>14 Ga Stainless Steel 304 (1.7mm)                                              | Date 03-Nov-22                         |
| Color<br>Couleur                                        | Unpainted<br>Finish<br>Fini                                                                      | Brushed                                |
| Description<br>1412BTSSCU 800A - 4Wires x 48" Assembly  |                                                                                                  | Detail Rev.                            |
| Part Number<br>Numéro Pièce<br><b>1412BTSSCU04804DT</b> |                                                                                                  | Rev. 0<br>3<br>15                      |

This drawing is confidential and must not be reproduced or used without the consent of EXM

Ce dessin est confidentiel et ne doit pas être reproduit ou utilisé sans le consentement de EXM



TOP

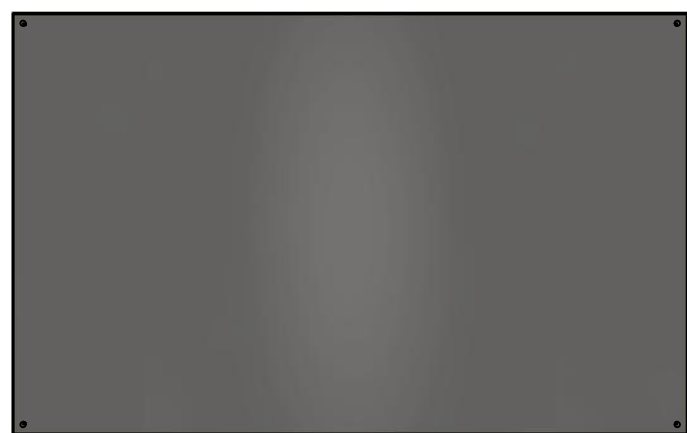

BACK

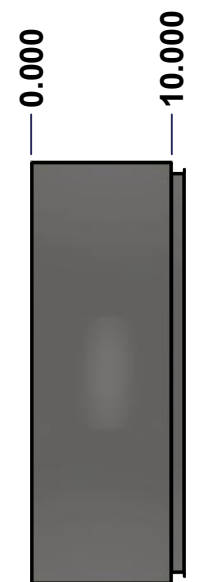

LEFT

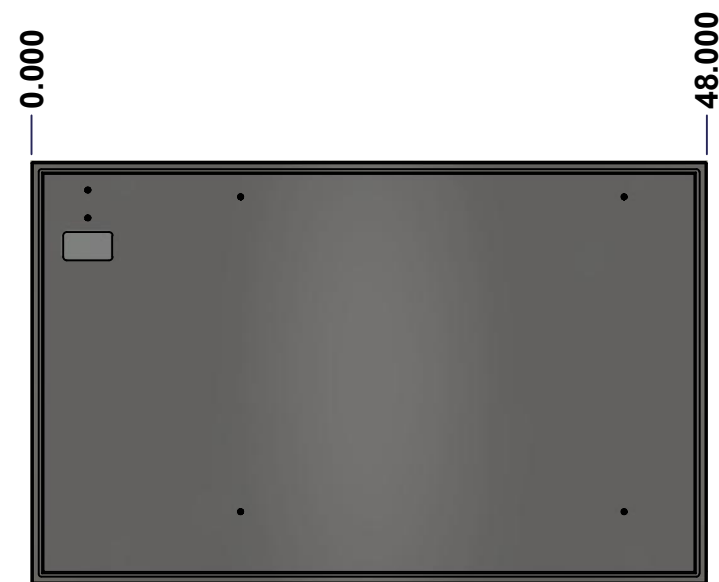

FRONT

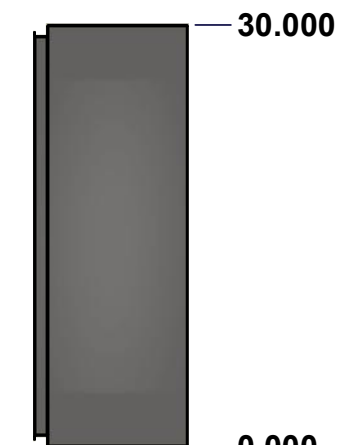

RIGHT



BOTTOM

| No. | Revisions | Date | By/Par |
|-----|-----------|------|--------|
|     |           |      |        |
|     |           |      |        |
|     |           |      |        |
|     |           |      |        |
|     |           |      |        |

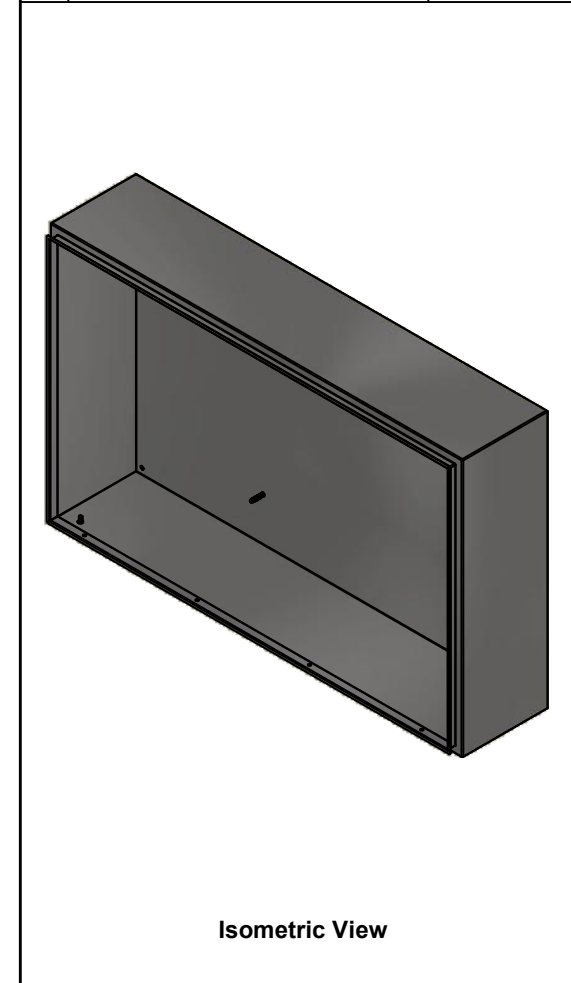

Isometric View



|                                                       |                                        |
|-------------------------------------------------------|----------------------------------------|
|                                                       | Flatness<br>Aplatissement<br>Max 3.0mm |
|                                                       | Projection<br>                         |
| Customer Client                                       | Date                                   |
| Drawn By<br>Dessiné Par BoxCad: BoxCad                | Date 03-Nov-22                         |
| Material<br>Matière 14 Ga Stainless Steel 304 (1.7mm) |                                        |
| Color<br>Couleur Unpainted                            | Finish<br>Fini Brushed                 |
| Description<br>1412BTSSCU 30" x 48" x 10" Body        |                                        |
| Part Number<br>Numéro Pièce <b>1412BTSSCU04804DTB</b> |                                        |
| Rev. 0                                                | 4<br>15                                |

SEE BILL OF MATERIAL ON LAST PAGE

This drawing is confidential and must not be reproduced or used without the consent of Eurobox

Ce dessin est confidentiel et ne doit pas être reproduit ou utilisé sans le consentement de Eurobox

**STANDARD FEATURES ARE NOT LISTED IN THIS HOLE TABLE**

**HOLE TABLE - BACK VIEW (CUSTOM FEATURE ONLY)**

| CUT-OUT | XDIM   | YDIM   | DESCRIPTION                 |
|---------|--------|--------|-----------------------------|
| 1       | 44.000 | 28.000 | GND STUD M8 x 35mm (Inside) |
| 2       | 44.000 | 26.000 | GND STUD M8 x 35mm (Inside) |
| 3       | 5.875  | 27.500 | IP STUD M8 x 35mm (Inside)  |
| 4       | 33.125 | 27.500 | IP STUD M8 x 35mm (Inside)  |
| 5       | 5.875  | 5.125  | IP STUD M8 x 35mm (Inside)  |
| 6       | 33.125 | 5.125  | IP STUD M8 x 35mm (Inside)  |

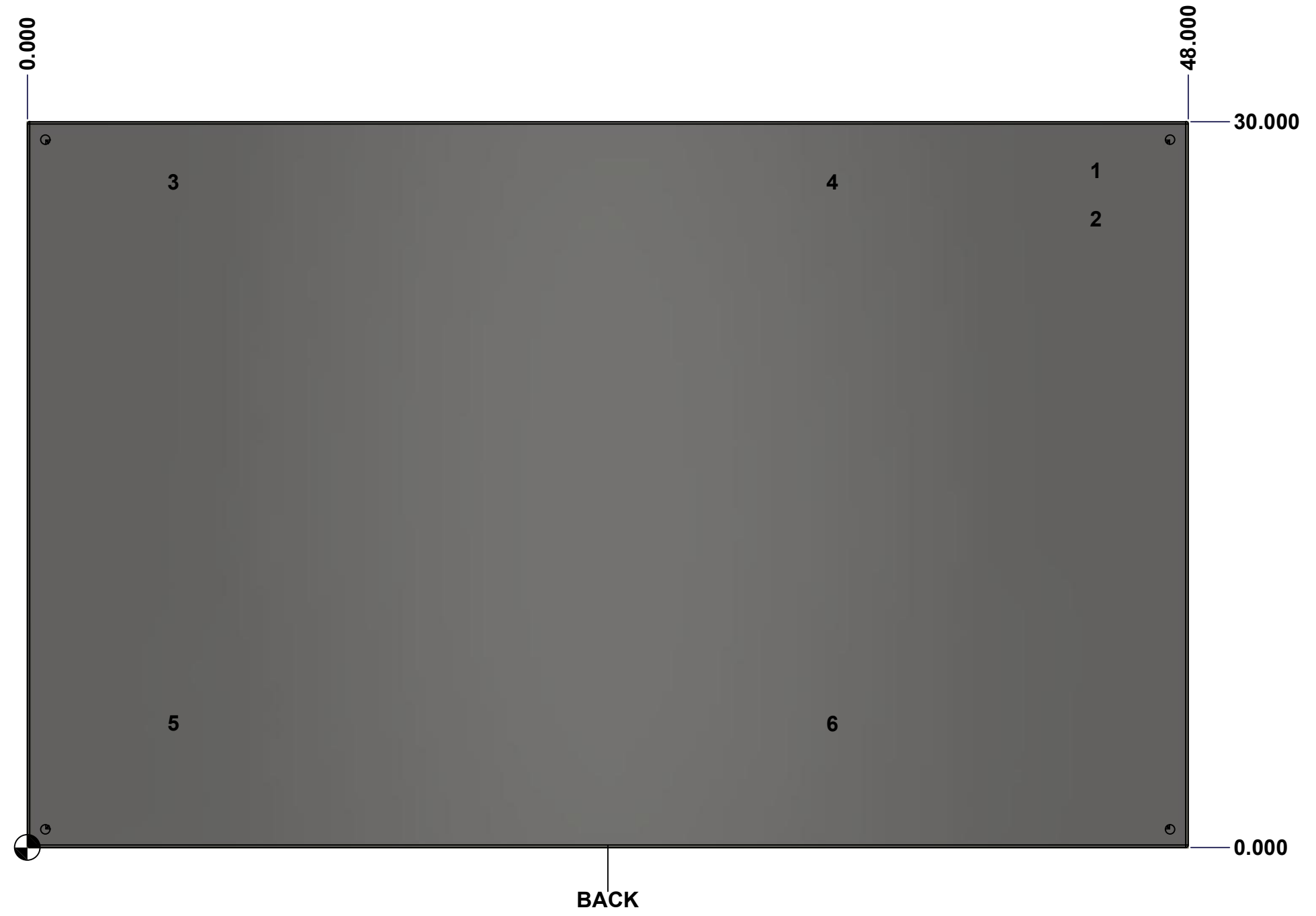



|  |                                 |              |
|--|---------------------------------|--------------|
|  | Description                     | Status       |
|  | 1412BTSSCU 30" x 48" x 10" Body | (NULL)       |
|  | Part Number<br>Numéro Pièce     | Rev.         |
|  | <b>1412BTSSCU04804DTB</b>       | <b>0</b> / 5 |
|  |                                 | 15           |

This drawing is confidential and must not be reproduced or used without the consent of EXM

Ce dessin est confidentiel et ne doit pas être reproduit ou utilisé sans le consentement de EXM

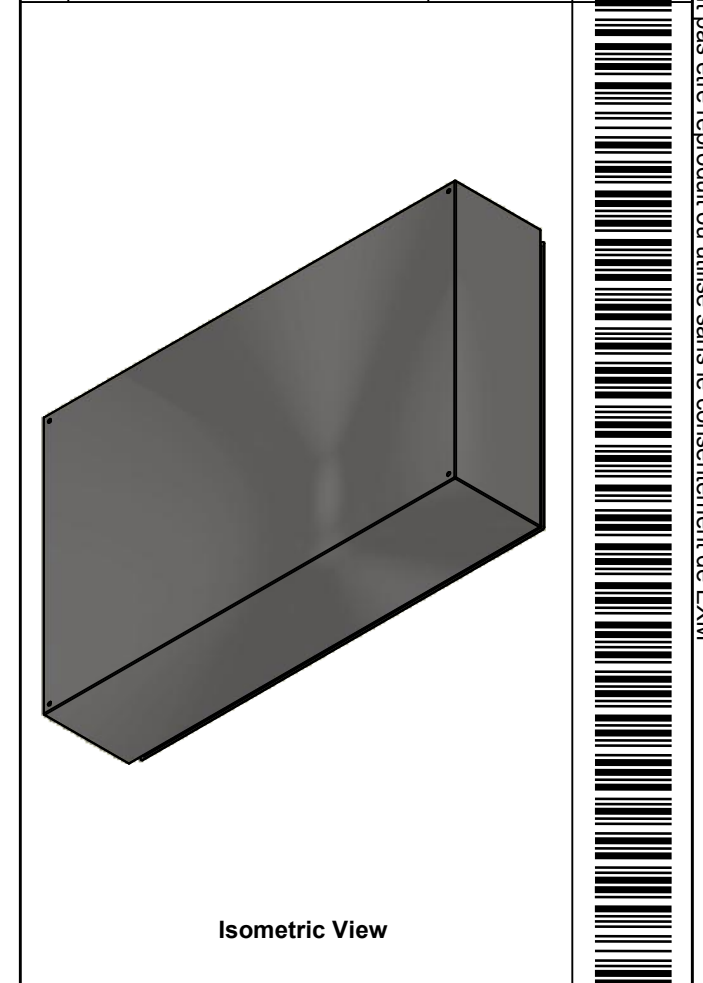
| No. | Revisions | Date | By/Par |
|-----|-----------|------|--------|
|     |           |      |        |
|     |           |      |        |
|     |           |      |        |
|     |           |      |        |
|     |           |      |        |

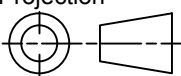

|                                                                                                                                                                                        |                        |                                                                                                     |
|----------------------------------------------------------------------------------------------------------------------------------------------------------------------------------------|------------------------|-----------------------------------------------------------------------------------------------------|
|  Tél: (450) 979-4373<br>Fax: (450) 979-4626<br><a href="http://www.exmweb.com">www.exmweb.com</a> |                        | Flatness<br>Aplatissement<br>Max 3.0mm                                                              |
| Customer Client                                                                                                                                                                        |                        | Projection<br> |
| Drawn By / Dessiné Par: BoxCad: BoxCad                                                                                                                                                 |                        | Date: 03-Nov-22                                                                                     |
| Material / Matière: 14 Ga Stainless Steel 304 (1.7mm)                                                                                                                                  |                        |                                                                                                     |
| Color / Couleur: Unpainted                                                                                                                                                             | Finish / Fini: Brushed |                                                                                                     |
| Description: 1412BTSSCU 30" x 48" x 10" Body                                                                                                                                           |                        | Detail Rev.                                                                                         |
| Part Number / Numéro Pièce: <b>1412BTSSCU04804DTB</b>                                                                                                                                  |                        | Rev. 6<br><b>0</b>                                                                                  |

| Qty        | Part Number          | Rev | Description                            |
|------------|----------------------|-----|----------------------------------------|
| 6          | STK-Q-16020          | 1   | Stud M8 x 35mm Stainless Steel         |
| 1          | STK-Q-16095          | 0   | M6 x 16mm Stainless Steel Ground Stud  |
| 1          | STK-S-00100          | 0   | 3.5" x 2" Silver Milar Flexcon Sticker |
| 1          | 1412BTSSCU04804DTB-P | 0   | 1412BTSSCU 30" x 48" x 10" Body Part   |
| Parts List |                      |     |                                        |

This drawing is confidential and must not be reproduced or used without the consent of Eurobex

Ce dessin est confidentiel et ne doit pas être reproduit ou utilisé sans le consentement de Eurobex

**STANDARD FEATURES ARE NOT LISTED IN THIS HOLE TABLE**

**HOLE TABLE - FRONT VIEW (CUSTOM FEATURE ONLY)**

| CUT-OUT | XDIM   | YDIM  | DESCRIPTION                  |
|---------|--------|-------|------------------------------|
| 1       | 33.000 | 1.500 | RND Ø0.201 THREAD 1/4-20 UNC |
| 2       | 27.000 | 1.500 | RND Ø0.201 THREAD 1/4-20 UNC |
| 3       | 21.000 | 1.500 | RND Ø0.201 THREAD 1/4-20 UNC |
| 4       | 15.000 | 1.500 | RND Ø0.201 THREAD 1/4-20 UNC |
| 5       | 9.000  | 1.500 | RND Ø0.201 THREAD 1/4-20 UNC |
| 6       | 3.000  | 1.500 | RND Ø0.201 THREAD 1/4-20 UNC |

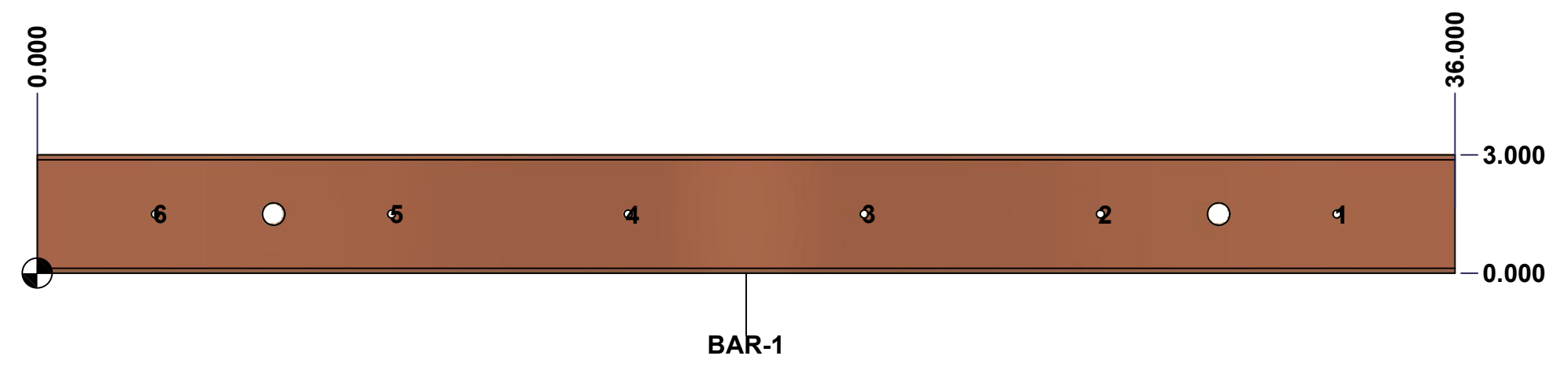

|                                  |                                   |      |        |    |
|----------------------------------|-----------------------------------|------|--------|----|
|                                  | Description                       |      | Status |    |
|                                  | Rounded Edge Copper Bar 1/4" x 3" |      | (NULL) |    |
| Part Number<br>Numéro Pièce      |                                   | Rev. | 7      |    |
| <b>1412BTSSCU04804DTBAR1-P 0</b> |                                   |      |        | 15 |

This drawing is confidential and must not be reproduced or used without the consent of Eurobex

Ce dessin est confidentiel et ne doit pas être reproduit ou utilisé sans le consentement de Eurobex

**STANDARD FEATURES ARE NOT LISTED IN THIS HOLE TABLE**

**HOLE TABLE - FRONT VIEW (CUSTOM FEATURE ONLY)**

| CUT-OUT | XDIM   | YDIM  | DESCRIPTION                  |
|---------|--------|-------|------------------------------|
| 1       | 33.000 | 1.500 | RND Ø0.201 THREAD 1/4-20 UNC |
| 2       | 27.000 | 1.500 | RND Ø0.201 THREAD 1/4-20 UNC |
| 3       | 21.000 | 1.500 | RND Ø0.201 THREAD 1/4-20 UNC |
| 4       | 15.000 | 1.500 | RND Ø0.201 THREAD 1/4-20 UNC |
| 5       | 9.000  | 1.500 | RND Ø0.201 THREAD 1/4-20 UNC |
| 6       | 3.000  | 1.500 | RND Ø0.201 THREAD 1/4-20 UNC |

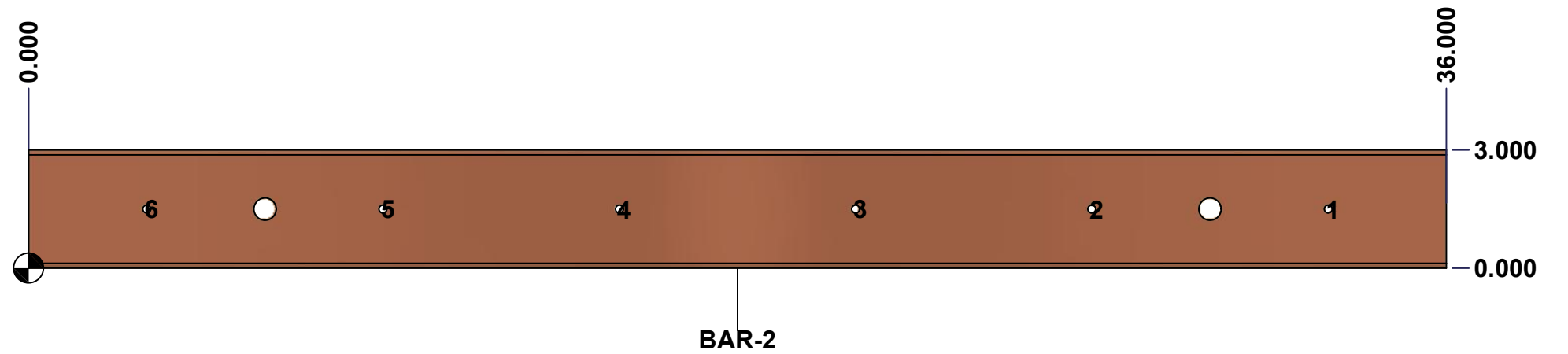

|                                  |                                   |      |        |
|----------------------------------|-----------------------------------|------|--------|
|                                  | Description                       |      | Status |
|                                  | Rounded Edge Copper Bar 1/4" x 3" |      | (NULL) |
| Part Number<br>Numéro Pièce      |                                   | Rev. | 8      |
| <b>1412BTSSCU04804DTBAR2-P 0</b> |                                   | 15   |        |



This drawing is confidential and must not be reproduced or used without the consent of Eurobex

Ce dessin est confidentiel et ne doit pas être reproduit ou utilisé sans le consentement de Eurobex

**STANDARD FEATURES ARE NOT LISTED IN THIS HOLE TABLE**

**HOLE TABLE - FRONT VIEW (CUSTOM FEATURE ONLY)**

| CUT-OUT | XDIM   | YDIM  | DESCRIPTION                  |
|---------|--------|-------|------------------------------|
| 1       | 33.000 | 1.500 | RND Ø0.201 THREAD 1/4-20 UNC |
| 2       | 27.000 | 1.500 | RND Ø0.201 THREAD 1/4-20 UNC |
| 3       | 21.000 | 1.500 | RND Ø0.201 THREAD 1/4-20 UNC |
| 4       | 15.000 | 1.500 | RND Ø0.201 THREAD 1/4-20 UNC |
| 5       | 9.000  | 1.500 | RND Ø0.201 THREAD 1/4-20 UNC |
| 6       | 3.000  | 1.500 | RND Ø0.201 THREAD 1/4-20 UNC |

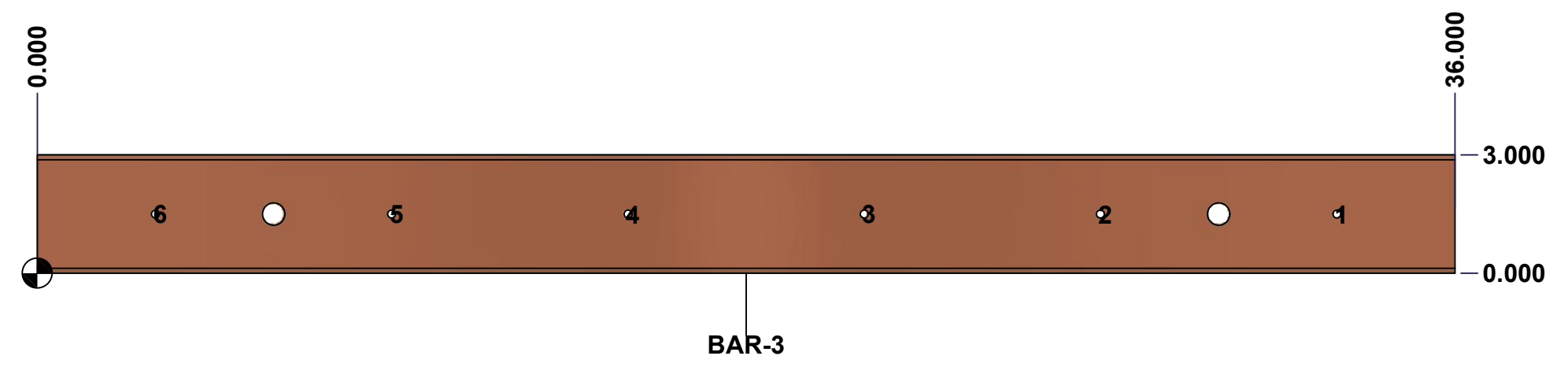

|                                  |                                   |      |        |
|----------------------------------|-----------------------------------|------|--------|
|                                  | Description                       |      | Status |
|                                  | Rounded Edge Copper Bar 1/4" x 3" |      | (NULL) |
| Part Number<br>Numéro Pièce      |                                   | Rev. | 9      |
| <b>1412BTSSCU04804DTBAR3-P 0</b> |                                   | 15   |        |

This drawing is confidential and must not be reproduced or used without the consent of Eurobex

Ce dessin est confidentiel et ne doit pas être reproduit ou utilisé sans le consentement de Eurobex

| STANDARD FEATURES ARE NOT LISTED IN THIS HOLE TABLE |        |       |                              |
|-----------------------------------------------------|--------|-------|------------------------------|
| HOLE TABLE - FRONT VIEW (CUSTOM FEATURE ONLY)       |        |       |                              |
| CUT-OUT                                             | XDIM   | YDIM  | DESCRIPTION                  |
| 1                                                   | 33.000 | 1.500 | RND Ø0.201 THREAD 1/4-20 UNC |
| 2                                                   | 27.000 | 1.500 | RND Ø0.201 THREAD 1/4-20 UNC |
| 3                                                   | 21.000 | 1.500 | RND Ø0.201 THREAD 1/4-20 UNC |
| 4                                                   | 15.000 | 1.500 | RND Ø0.201 THREAD 1/4-20 UNC |
| 5                                                   | 9.000  | 1.500 | RND Ø0.201 THREAD 1/4-20 UNC |
| 6                                                   | 3.000  | 1.500 | RND Ø0.201 THREAD 1/4-20 UNC |

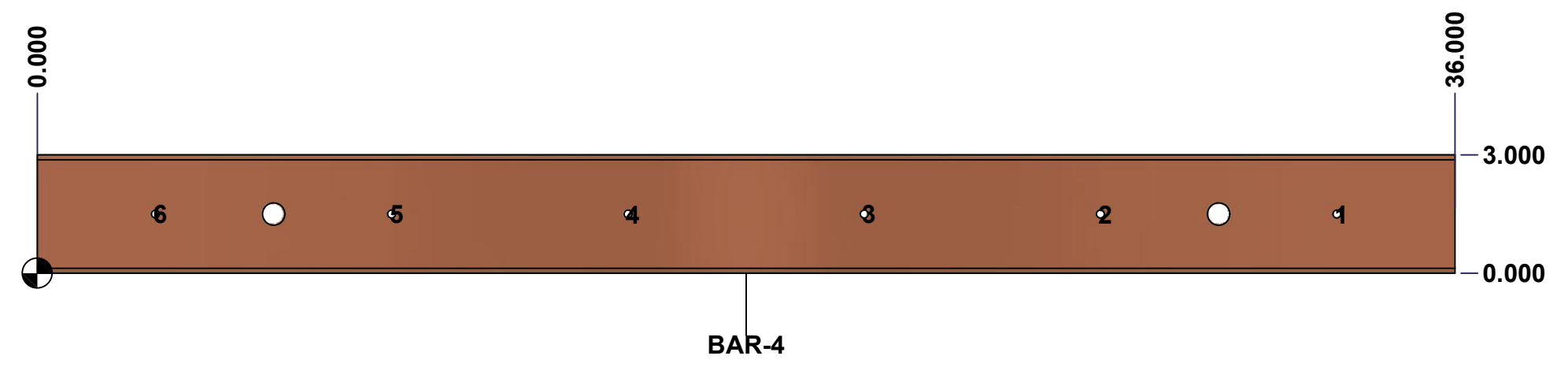

|                                  |                                   |      |        |    |
|----------------------------------|-----------------------------------|------|--------|----|
|                                  | Description                       |      | Status |    |
|                                  | Rounded Edge Copper Bar 1/4" x 3" |      | (NULL) |    |
| Part Number<br>Numéro Pièce      |                                   | Rev. | 10     | 15 |
| <b>1412BTSSCU04804DTBAR4-P 0</b> |                                   |      |        |    |

This drawing is confidential and must not be reproduced or used without the consent of EXM

Ce dessin est confidentiel et ne doit pas être reproduit ou utilisé sans le consentement de EXM



TOP

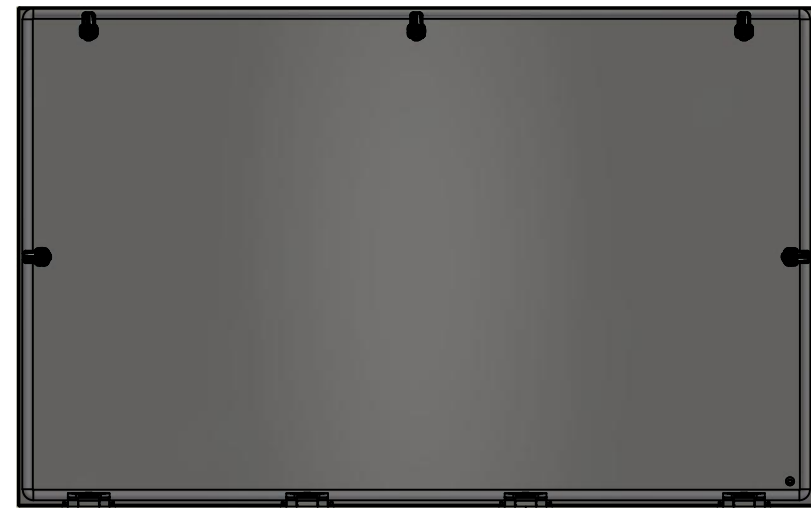

BACK

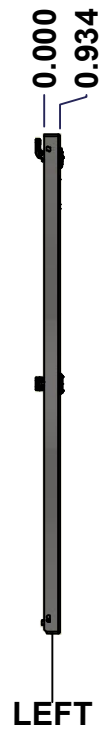

LEFT

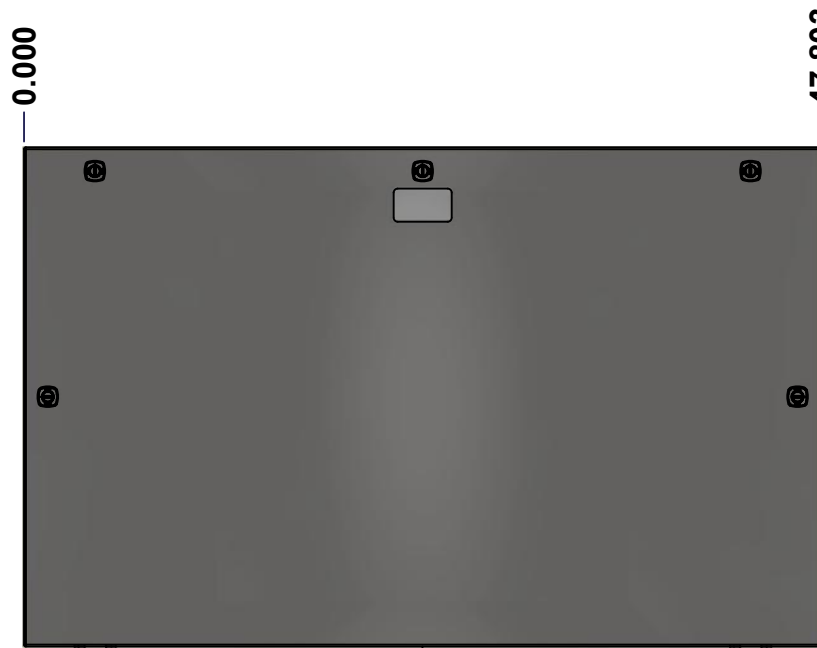

FRONT

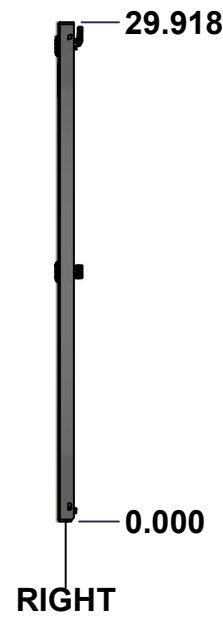

RIGHT



BOTTOM

| No. | Revisions | Date | By/Par |
|-----|-----------|------|--------|
|     |           |      |        |
|     |           |      |        |
|     |           |      |        |
|     |           |      |        |

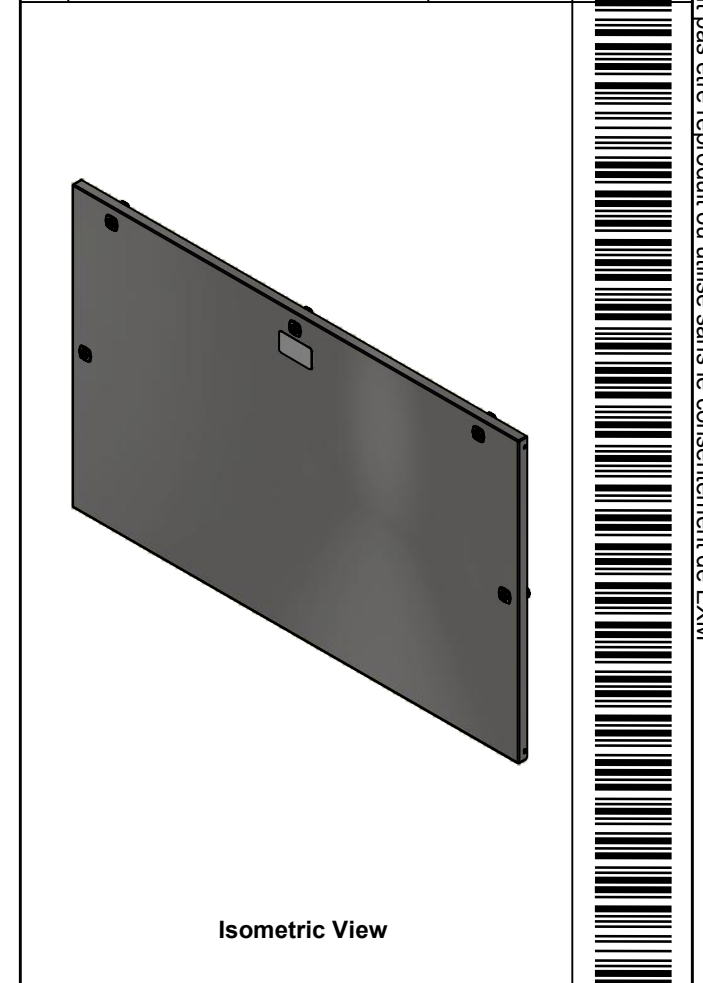

Isometric View

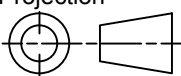
|                                                                                                                                                                                        |                                   |                                                                                                                                               |
|----------------------------------------------------------------------------------------------------------------------------------------------------------------------------------------|-----------------------------------|-----------------------------------------------------------------------------------------------------------------------------------------------|
|  Tél: (450) 979-4373<br>Fax: (450) 979-4626<br><a href="http://www.exmweb.com">www.exmweb.com</a> |                                   | Flatness<br>Aplatissement<br>Max 3.0mm<br>Projection<br> |
| Customer Client                                                                                                                                                                        | Date                              |                                                                                                                                               |
| Drawn By<br>Dessiné Par                                                                                                                                                                | BoxCad: BoxCad                    | Date 03-Nov-22                                                                                                                                |
| Material<br>Matière                                                                                                                                                                    | 14 Ga Stainless Steel 304 (1.7mm) |                                                                                                                                               |
| Color<br>Couleur                                                                                                                                                                       | Unpainted                         | Finish<br>Fini Brushed                                                                                                                        |
| Description                                                                                                                                                                            | Detail Rev.                       |                                                                                                                                               |
| 1412BTSSCU 30" x 48" Cover                                                                                                                                                             |                                   |                                                                                                                                               |
| Part Number<br>Numéro Pièce                                                                                                                                                            | Rev. 0                            | 11 / 15                                                                                                                                       |

SEE BILL OF MATERIAL ON LAST PAGE

**1412BTSSCU04804DTC**

This drawing is confidential and must not be reproduced or used without the consent of Eurobox

Ce dessin est confidentiel et ne doit pas être reproduit ou utilisé sans le consentement de Eurobox

**STANDARD FEATURES ARE NOT LISTED IN THIS HOLE TABLE**

**HOLE TABLE - FRONT VIEW (CUSTOM FEATURE ONLY)**

| CUT-OUT | XDIM   | YDIM   | DESCRIPTION                  |
|---------|--------|--------|------------------------------|
| 1       | 1.500  | 1.486  | GND STUD M6 x 16mm (Inside)  |
| 2       | 46.379 | 14.959 | LOCK 880 SCQ4-SLSS6 @ 0.0°   |
| 3       | 1.424  | 14.959 | LOCK 880 SCQ4-SLSS6 @ 180.0° |
| 4       | 43.553 | 28.494 | LOCK 880 SCQ4-SLSS6 @ 90.0°  |
| 5       | 23.902 | 28.494 | LOCK 880 SCQ4-SLSS6 @ 90.0°  |
| 6       | 4.250  | 28.494 | LOCK 880 SCQ4-SLSS6 @ 90.0°  |

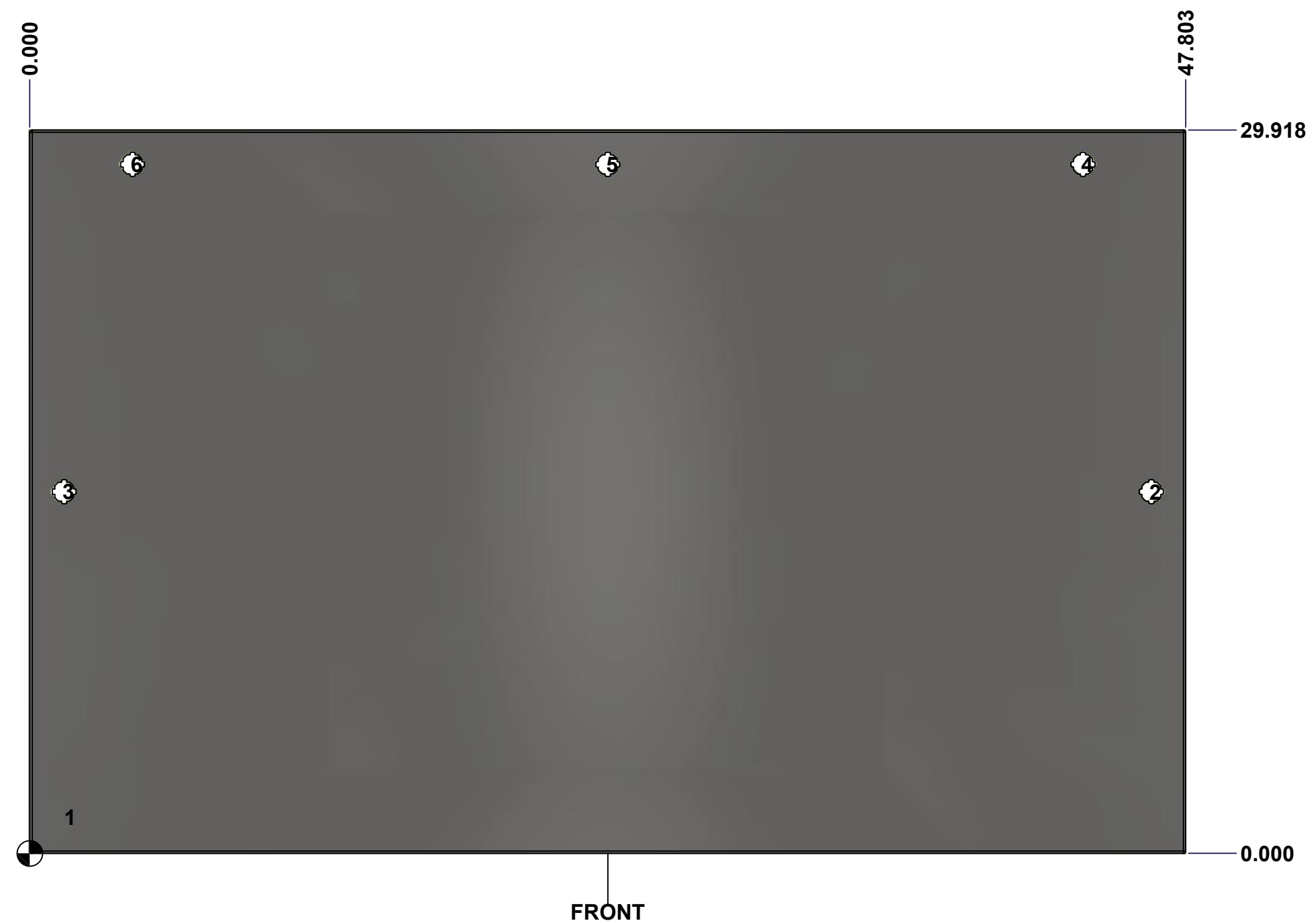

|  |                             |          |    |
|--|-----------------------------|----------|----|
|  | Description                 | Status   |    |
|  | 1412BTSSCU 30" x 48" Cover  | (NULL)   |    |
|  | Part Number<br>Numéro Pièce | Rev.     | 12 |
|  | <b>1412BTSSCU04804DTC</b>   | <b>0</b> | 15 |

This drawing is confidential and must not be reproduced or used without the consent of EXM

Ce dessin est confidentiel et ne doit pas être reproduit ou utilisé sans le consentement de EXM

| No. | Revisions | Date | By/Par |
|-----|-----------|------|--------|
|     |           |      |        |
|     |           |      |        |
|     |           |      |        |
|     |           |      |        |
|     |           |      |        |

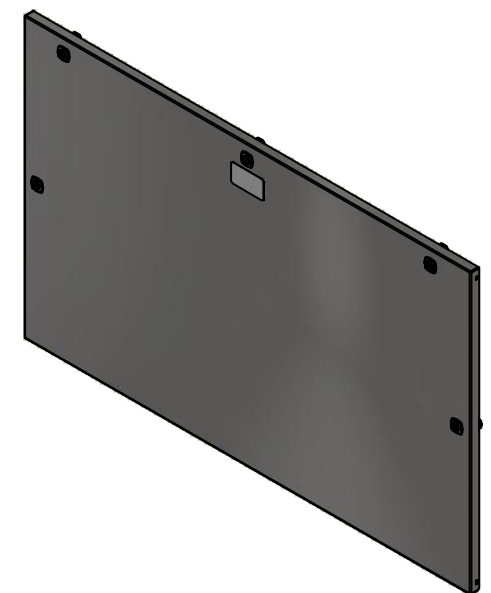

Isometric View



Tél: (450) 979-4373  
 Fax: (450) 979-4626  
[www.exmweb.com](http://www.exmweb.com)

Flatness  
Aplatissement  
Max 3.0mm  
Projection

|                                        |                 |
|----------------------------------------|-----------------|
| Customer Client                        | Date            |
| Drawn By / Dessiné Par: BoxCad: BoxCad | Date: 03-Nov-22 |

Material / Matière: 14 Ga Stainless Steel 304 (1.7mm)

|                            |                        |
|----------------------------|------------------------|
| Color / Couleur: Unpainted | Finish / Fini: Brushed |
|----------------------------|------------------------|

|                                         |             |
|-----------------------------------------|-------------|
| Description: 1412BTSSCU 30" x 48" Cover | Detail Rev. |
|-----------------------------------------|-------------|

|                                                       |               |    |
|-------------------------------------------------------|---------------|----|
| Part Number / Numéro Pièce: <b>1412BTSSCU04804DTC</b> | Rev. <b>0</b> | 13 |
|                                                       |               | 15 |

| Qty        | Part Name            | Rev | Description                              |
|------------|----------------------|-----|------------------------------------------|
| 1          | 1412BTSSCU04804DTG   | 0   | 1412BTSSCU 30" x 48" Cover Gasket        |
| 4          | STK-K-09850          | 6   | 5412 ESS Hinge with 2 Captive Hinge Pins |
| 1          | STK-Q-16095          | 0   | M6 x 16mm Stainless Steel Ground Stud    |
| 1          | STK-S-00100          | 0   | 3.5" x 2" Silver Milar Flexcon Sticker   |
| 1          | 1412BTSSCU04804DTC-P | 0   | 1412BTSSCU 30" x 48" Cover Part          |
| 5          | 880 SCQ4-SLSS6       | 7   | 5412 ESS 1/4 Turn Lock                   |
| Parts List |                      |     |                                          |

This drawing is confidential and must not be reproduced or used without the consent of EXM

Ce dessin est confidentiel et ne doit pas être reproduit ou utilisé sans le consentement de EXM

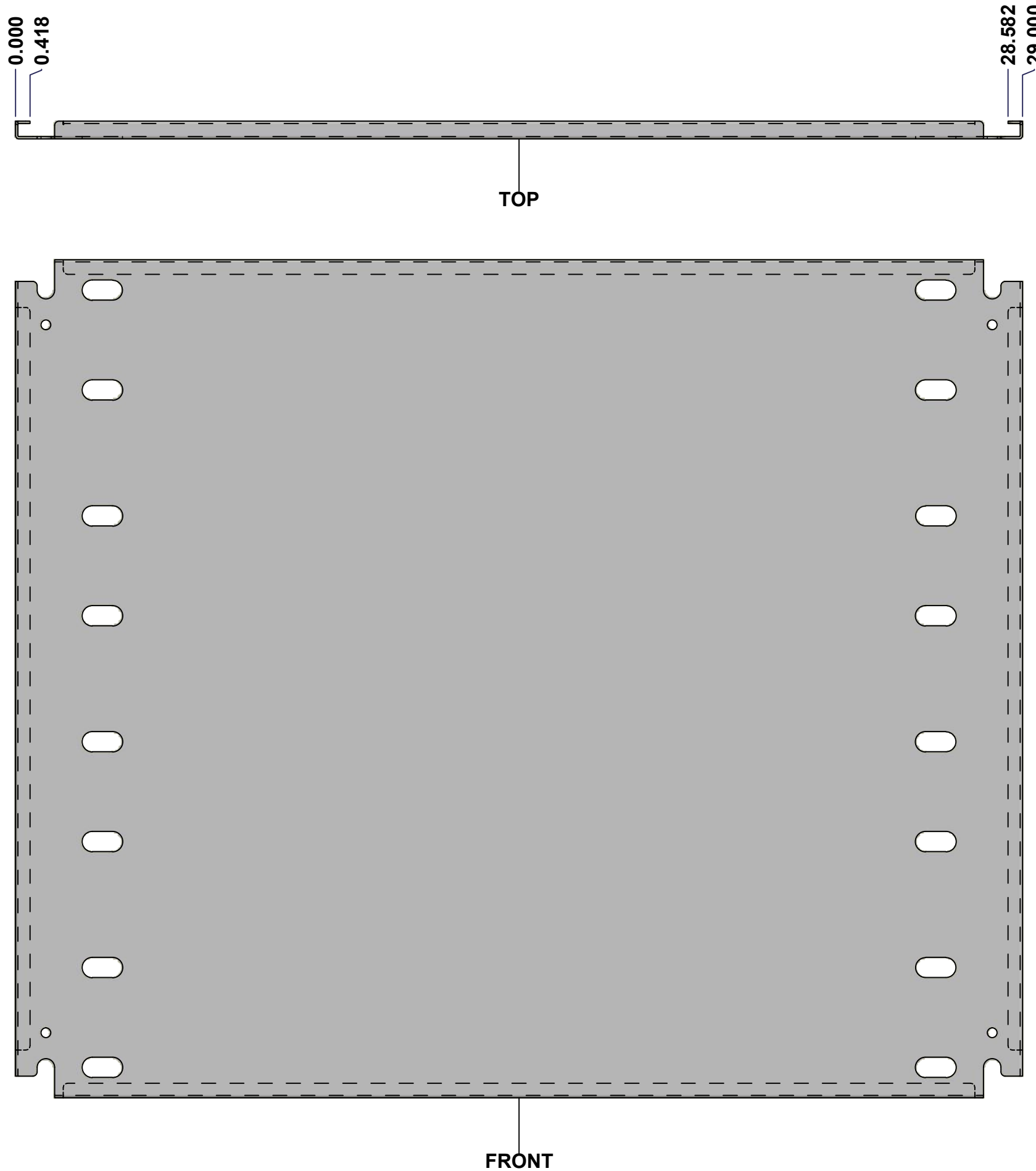

| No. | Revisions | Date | By/Par |
|-----|-----------|------|--------|
|     |           |      |        |
|     |           |      |        |
|     |           |      |        |
|     |           |      |        |
|     |           |      |        |

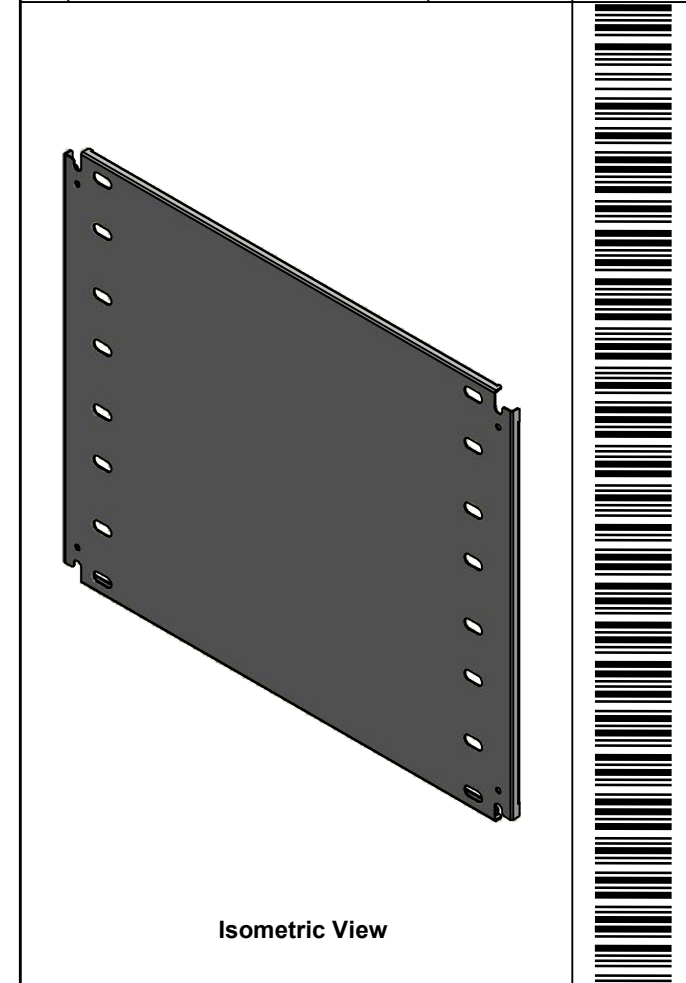

|                                                                                                           |                                                    |
|-----------------------------------------------------------------------------------------------------------|----------------------------------------------------|
| <p>Tél: (450) 979-4373<br/>Fax: (450) 979-4626<br/><a href="http://www.exmweb.com">www.exmweb.com</a></p> | <p>Flatness<br/>Aplatissement</p> <p>Max 3.0mm</p> |
|                                                                                                           | <p>Projection</p>                                  |
| Customer Client                                                                                           | Date                                               |
| Drawn By<br>Dessiné Par BoxCad: BoxCad                                                                    | Date 03-Nov-22                                     |
| Material<br>Matière 14 Ga Cold Rolled A1008 CS Type B (1.7mm)                                             |                                                    |
| Color<br>Couleur White RAL9003                                                                            | Finish<br>Fini Smooth                              |
| Description<br>1412BTSSCU 24.125" x 29" Inner Panel                                                       |                                                    |
| Part Number<br>Numéro Pièce <b>1412BTSSCU04804DTIP1</b>                                                   | Detail Rev.<br>Rev. 14<br><b>0</b>                 |

SEE BILL OF MATERIAL ON LAST PAGE

This drawing is confidential and must not be reproduced or used without the consent of EXM

Ce dessin est confidentiel et ne doit pas être reproduit ou utilisé sans le consentement de EXM

| No. | Revisions | Date | By/Par |
|-----|-----------|------|--------|
|     |           |      |        |
|     |           |      |        |
|     |           |      |        |
|     |           |      |        |
|     |           |      |        |

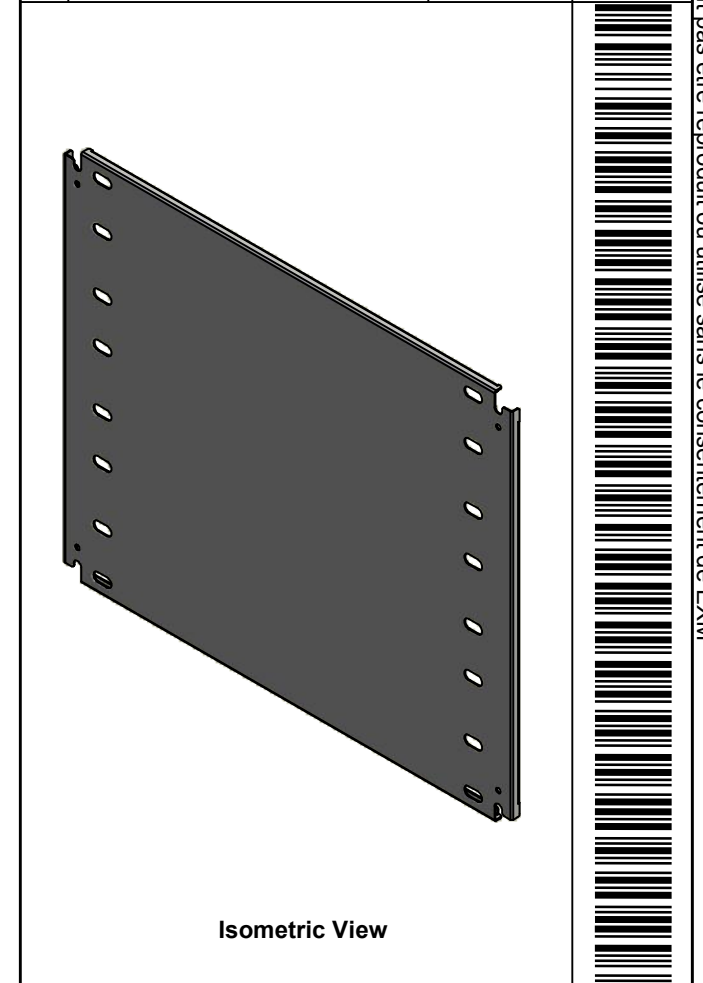

Isometric View

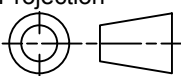

|                                                                                                                                                                                        |                                                                                                     |
|----------------------------------------------------------------------------------------------------------------------------------------------------------------------------------------|-----------------------------------------------------------------------------------------------------|
|  Tél: (450) 979-4373<br>Fax: (450) 979-4626<br><a href="http://www.exmweb.com">www.exmweb.com</a> | Flatness<br>Aplatissement<br>Max 3.0mm                                                              |
|                                                                                                                                                                                        | Projection<br> |
| Customer Client                                                                                                                                                                        | Date                                                                                                |
| Drawn By<br>Dessiné Par BoxCad: BoxCad                                                                                                                                                 | Date 03-Nov-22                                                                                      |
| Material<br>Matière 14 Ga Cold Rolled A1008 CS Type B (1.7mm)                                                                                                                          |                                                                                                     |
| Color<br>Couleur White RAL9003                                                                                                                                                         | Finish<br>Fini Smooth                                                                               |
| Description<br>1412BTSSCU 24.125" x 29" Inner Panel                                                                                                                                    |                                                                                                     |
| Part Number<br>Numéro Pièce<br><b>1412BTSSCU04804DTIP1</b>                                                                                                                             | Detail Rev.<br>Rev. 15<br><b>0</b>                                                                  |

| Qty        | Part Number            | Rev | Description                               |
|------------|------------------------|-----|-------------------------------------------|
| 1          | STK-P-02401S           | 0   | Powder Paint (White / Smooth)             |
| 1          | 1412BTSSCU04804DTIP1-P | 0   | 1412BTSSCU 24.125" x 48" Inner Panel Part |
| Parts List |                        |     |                                           |