

This drawing is confidential and must not be reproduced or used without the consent of EXM

Ce dessin est confidentiel et ne doit pas être reproduit ou utilisé sans le consentement de EXM

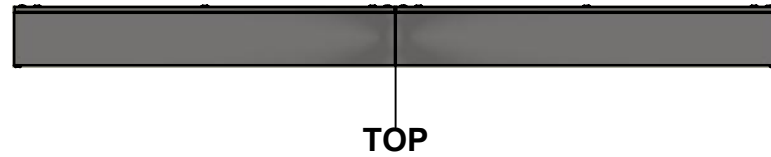

TOP

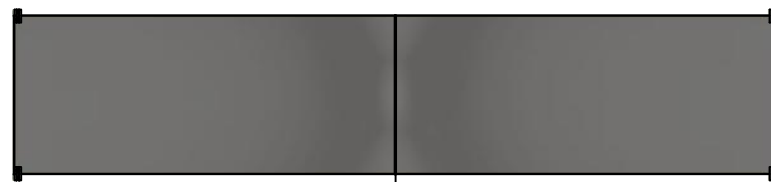

LEFT

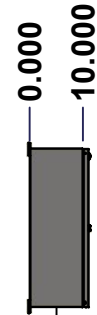

LEFT

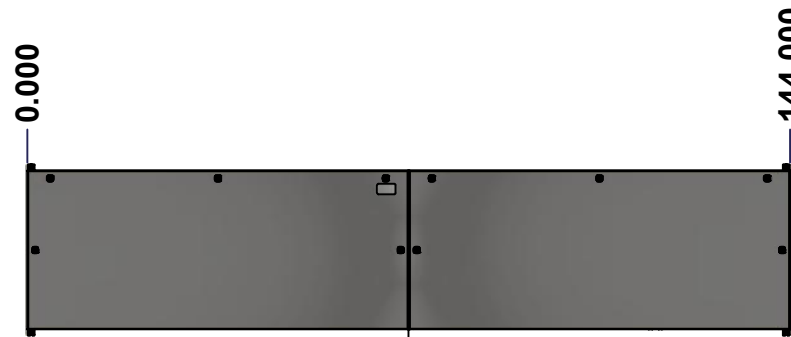

FRONT

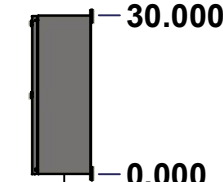

RIGHT



BOTTOM

No.	Revisions	Date	By/Par

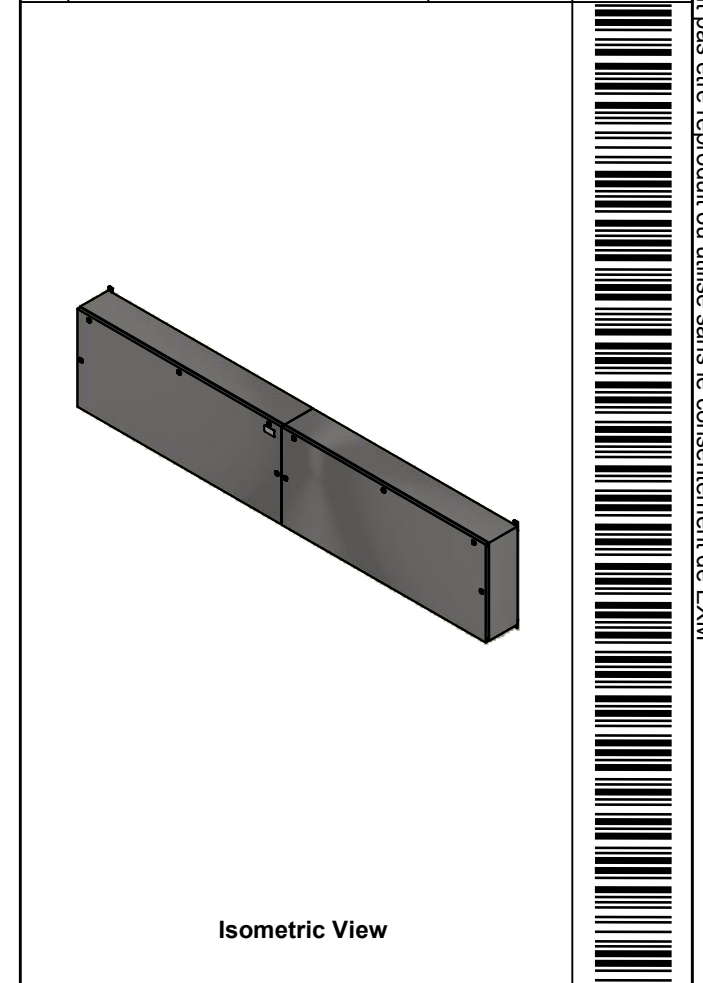

Isometric View

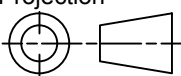

 Tél: (450) 979-4373 Fax: (450) 979-4626 www.exmweb.com		Flatness Aplatissement Max 3.0mm Projection 
Customer Client	Date	
Drawn By Dessiné Par	BoxCad: BoxCad	Date 03-Nov-22
Material Matière	14 Ga Stainless Steel 304 (1.7mm)	
Color Couleur	Unpainted	Finish Fini Brushed
Description	Detail Rev.	
1412BTSSCU 600A - 4Wires x 144" Assembly		
Part Number Numéro Pièce	Rev.	1
1412BTSSCU12604DT	0	17

SEE BILL OF MATERIAL ON LAST PAGE

This drawing is confidential and must not be reproduced or used without the consent of Eurobox

Ce dessin est confidentiel et ne doit pas être reproduit ou utilisé sans le consentement de Eurobox

STANDARD FEATURES ARE NOT LISTED IN THIS HOLE TABLE

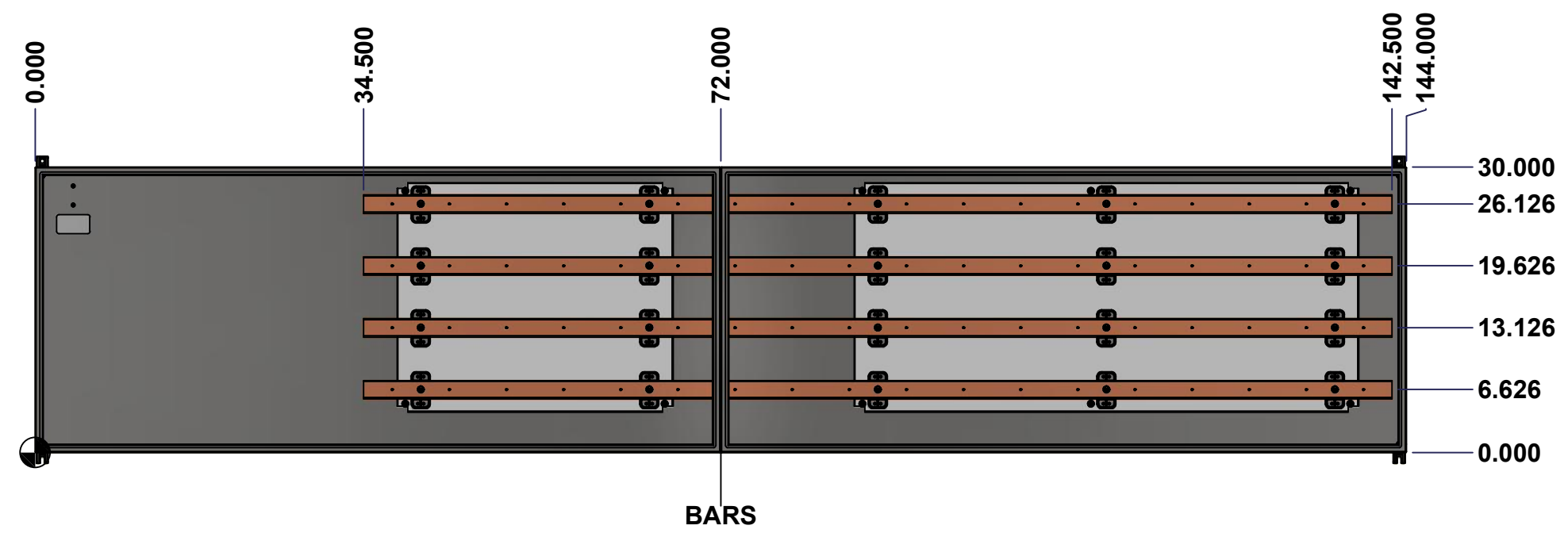

	Description 1412BTSSCU 600A - 4Wires x 144" Assembly		Status (NULL)	
	Part Number Numéro Pièce 1412BTSSCU12604DT		Rev. 0	2 17

This drawing is confidential and must not be reproduced or used without the consent of EXM

Ce dessin est confidentiel et ne doit pas être reproduit ou utilisé sans le consentement de EXM

NOTE	
ITEM	DESCRIPTION
1	NEMA 4X Enclosure
2	C/W Standard ground studs on box and cover
3	W/O Standard door stiffener
4	C/W Special inner panel (Sold separately)
5	C/W Standard inner panel mounting studs

No.	Revisions	Date	By/Par

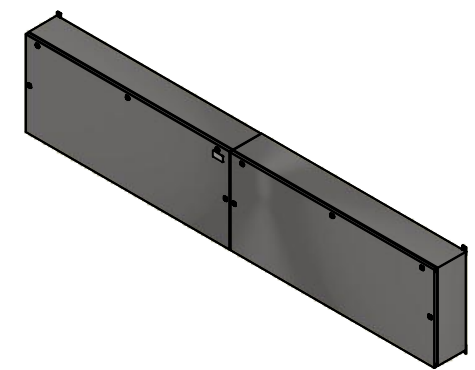

Isometric View



8	STK-Q-04051-07	8	M6 x 7mm Stainless Steel Hexagon Socket Head Machine Screw with Nyseal
1	885 ESMF2	0	885 ESMF2 Stainless Steel Mounting Feet Kit
1	1412BTSSCU12604DTIP2	0	1412BTSSCU 24.125" x 53" Right Inner Panel
1	1412BTSSCU12604DTBA R1-P	0	Rounded Edge Copper Bar 1/4" x 2"
1	1412BTSSCU12604DTBA R2-P	0	Rounded Edge Copper Bar 1/4" x 2"
1	1412BTSSCU12604DTBA R3-P	0	Rounded Edge Copper Bar 1/4" x 2"
1	1412BTSSCU12604DTBA R4-P	0	Rounded Edge Copper Bar 1/4" x 2"
1	1412BTSSCU12604DTIP1	0	1412BTSSCU 24.125" x 29" Left Inner Panel
20	STK-A-67400	0	Buss Bar Insulator Kit
1	STK-K-01800	5	5412 ES Accessory Kit
30	STK-Q-07310	2	Flange Lock Nut M8
10	STK-Q-07610	8	M8 Plastic Spacer 22.2mm
1	1412BTSSCU12604DTB	0	1412BTSSCU 30" x 144" x 10" Body
1	1412BTSSCU12604DTC	0	1412BTSSCU 30" x 144" Cover
Qty	Part Number	Rev	Description
Parts List			

PACKING		
ITEM	QTY	DESCRIPTION
Cardboard sleeve	2	Top and Bottom
Cardboard strip	2	Between back of enclosure and inner panel
Plastic bag	1	To protect cover surface and inside gasket
Cardboard corner	4	To reinforced for the plastic strap tightening
Plastic strap - Black	2	To Squeeze 2 cardboard sleeve together
Packaging label	3	White label with PN
Plastic strap- Green	2	To secure the enclosure to the wood pallet
Wood Pallet	1	2" deeper and 3" larger than enclosure size

Tél: (450) 979-4373
Fax: (450) 979-4626
www.exmweb.com

Flatness
Aplatissement
Max 3.0mm

Projection

Customer Client	Date
Drawn By Dessiné Par BoxCad: BoxCad	Date 03-Nov-22
Material Matière 14 Ga Stainless Steel 304 (1.7mm)	
Color Couleur Unpainted	Finish Fini Brushed
Description 1412BTSSCU 600A - 4Wires x 144" Assembly	Detail Rev.
Part Number Numéro Pièce 1412BTSSCU12604DT	Rev. 0

This drawing is confidential and must not be reproduced or used without the consent of EXM

Ce dessin est confidentiel et ne doit pas être reproduit ou utilisé sans le consentement de EXM

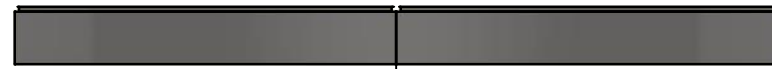

TOP

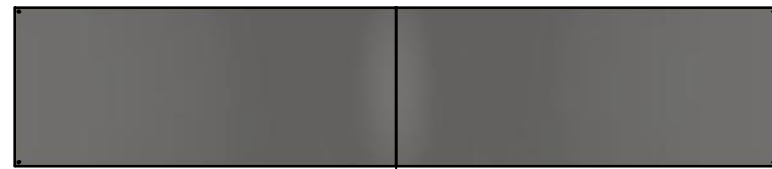

BACK

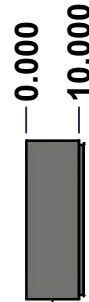

LEFT



FRONT

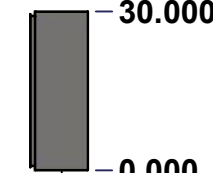

RIGHT



BOTTOM

No.	Revisions	Date	By/Par

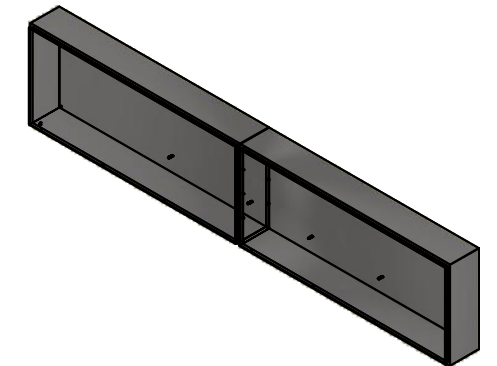

Isometric View



Tél: (450) 979-4373
 Fax: (450) 979-4626
www.exmweb.com

Flatness
Aplatissement

Max 3.0mm

Projection

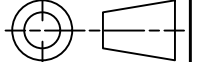

Customer Client	Date
Drawn By Dessiné Par BoxCad: BoxCad	Date 03-Nov-22
Material Matière 14 Ga Stainless Steel 304 (1.7mm)	
Color Couleur Unpainted	Finish Fini Brushed
Description 1412BTSSCU 30" x 144" x 10" Body	Detail Rev.
Part Number Numéro Pièce 1412BTSSCU12604DTB	Rev. 0

SEE BILL OF MATERIAL ON LAST PAGE

This drawing is confidential and must not be reproduced or used without the consent of Eurobox

Ce dessin est confidentiel et ne doit pas être reproduit ou utilisé sans le consentement de Eurobox

STANDARD FEATURES ARE NOT LISTED IN THIS HOLE TABLE

HOLE TABLE - BACK VIEW (CUSTOM FEATURE ONLY)

CUT-OUT	XDIM	YDIM	DESCRIPTION
1	140.000	28.000	GND STUD M8 x 35mm (Inside)
2	140.000	26.000	GND STUD M8 x 35mm (Inside)
3	5.875	27.500	IP STUD M8 x 35mm (Inside)
4	57.125	27.500	IP STUD M8 x 35mm (Inside)
5	5.875	5.125	IP STUD M8 x 35mm (Inside)
6	57.125	5.125	IP STUD M8 x 35mm (Inside)
7	77.875	27.500	IP STUD M8 x 35mm (Inside)
8	105.125	27.500	IP STUD M8 x 35mm (Inside)
9	77.875	5.125	IP STUD M8 x 35mm (Inside)
10	105.125	5.125	IP STUD M8 x 35mm (Inside)
11	33.125	27.500	IP STUD M8 x 35mm (Inside)
12	33.125	5.125	IP STUD M8 x 35mm (Inside)

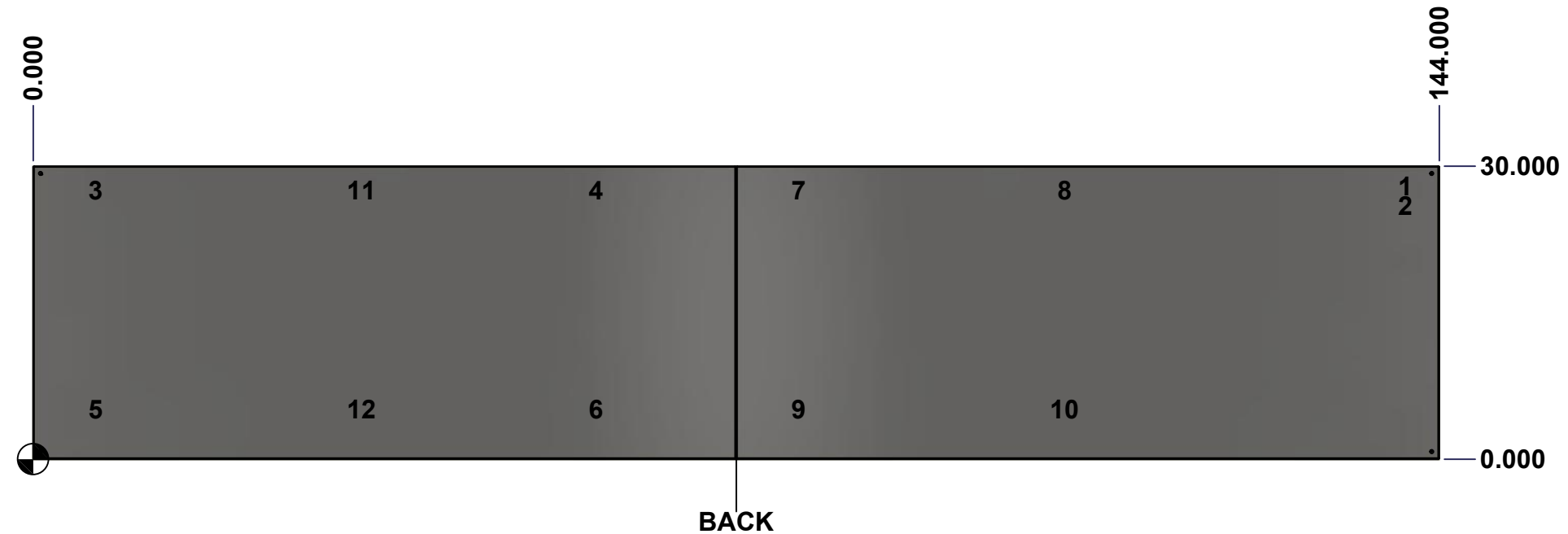

	Description	Status
	1412BTSSCU 30" x 144" x 10" Body	(NULL)
Part Number Numéro Pièce	1412BTSSCU12604DTB	Rev. 5
		0

This drawing is confidential and must not be reproduced or used without the consent of EXM

Ce dessin est confidentiel et ne doit pas être reproduit ou utilisé sans le consentement de EXM

No.	Revisions	Date	By/Par

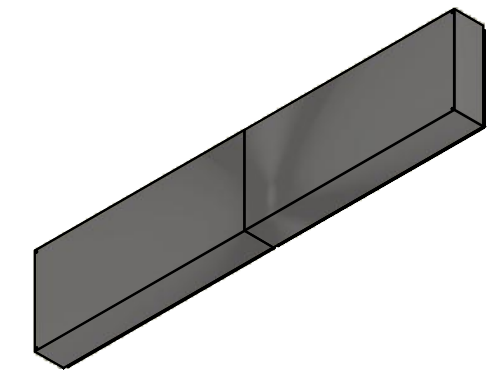

Isometric View



 Tél: (450) 979-4373
 Fax: (450) 979-4626
www.exmweb.com

Flatness / Aplatissement: Max 3.0mm
 Projection: 

Qty	Part Number	Rev	Description
1	1412BTSSCU12604DTB-P	0	1412BTSSCU 30" x 144" x 10" Left Body Part
1	1412BTSSCU12604DTE-P	0	1412BTSSCU 30" x 144" x 10" Right Body Part
1	STK-G-00701	0	1" x 1/4" Self-Adhesive Neoprene Gasket
10	STK-Q-00260	1	M6 x 13mm Carriage Bolt
10	STK-Q-07220	1	M6 Nylon Insert Lock Nut
12	STK-Q-16020	1	Stud M8 x 35mm Stainless Steel
2	STK-Q-16095	0	M6 x 16mm Stainless Steel Ground Stud
1	STK-S-00100	0	3.5" x 2" Silver Milar Flexcon Sticker
Parts List			

Customer Client:
 Drawn By / Dessiné Par: BoxCad: BoxCad
 Material / Matière: 14 Ga Stainless Steel 304 (1.7mm)
 Color / Couleur: Unpainted Finish / Fini: Brushed
 Description: 1412BTSSCU 30" x 144" x 10" Body
 Part Number / Numéro Pièce: **1412BTSSCU12604DTB**
 Rev. 0 6/17

This drawing is confidential and must not be reproduced or used without the consent of Eurobex

Ce dessin est confidentiel et ne doit pas être reproduit ou utilisé sans le consentement de Eurobex

STANDARD FEATURES ARE NOT LISTED IN THIS HOLE TABLE			
HOLE TABLE - FRONT VIEW (CUSTOM FEATURE ONLY)			
CUT-OUT	XDIM	YDIM	DESCRIPTION
1	105.000	1.000	RND Ø0.201 THREAD 1/4-20 UNC
2	99.000	1.000	RND Ø0.201 THREAD 1/4-20 UNC
3	93.000	1.000	RND Ø0.201 THREAD 1/4-20 UNC
4	87.000	1.000	RND Ø0.201 THREAD 1/4-20 UNC
5	81.000	1.000	RND Ø0.201 THREAD 1/4-20 UNC
6	75.000	1.000	RND Ø0.201 THREAD 1/4-20 UNC
7	69.000	1.000	RND Ø0.201 THREAD 1/4-20 UNC
8	63.000	1.000	RND Ø0.201 THREAD 1/4-20 UNC
9	57.000	1.000	RND Ø0.201 THREAD 1/4-20 UNC
10	51.000	1.000	RND Ø0.201 THREAD 1/4-20 UNC
11	45.000	1.000	RND Ø0.201 THREAD 1/4-20 UNC
12	39.000	1.000	RND Ø0.201 THREAD 1/4-20 UNC
13	33.000	1.000	RND Ø0.201 THREAD 1/4-20 UNC
14	27.000	1.000	RND Ø0.201 THREAD 1/4-20 UNC
15	21.000	1.000	RND Ø0.201 THREAD 1/4-20 UNC
16	15.000	1.000	RND Ø0.201 THREAD 1/4-20 UNC
17	9.000	1.000	RND Ø0.201 THREAD 1/4-20 UNC
18	3.000	1.000	RND Ø0.201 THREAD 1/4-20 UNC

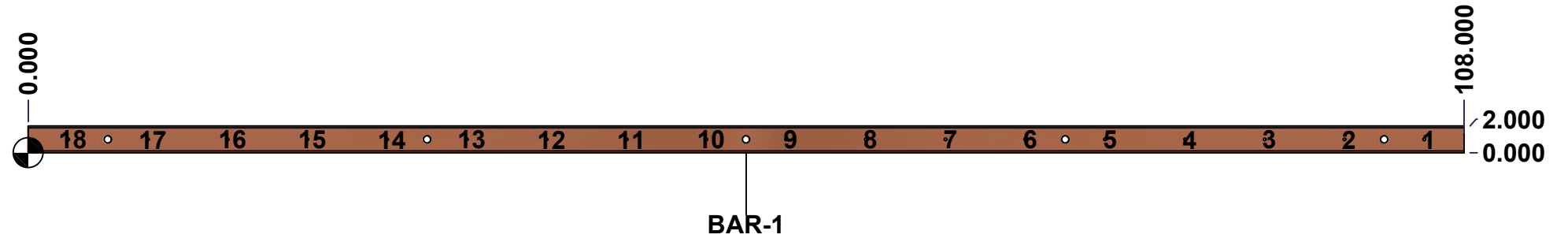

	Description	Status	
	Rounded Edge Copper Bar 1/4" x 2"	(NULL)	
	Part Number Numéro Pièce	Rev.	7
	1412BTSSCU12604DTBAR1-P 0		17

This drawing is confidential and must not be reproduced or used without the consent of Eurobex

Ce dessin est confidentiel et ne doit pas être reproduit ou utilisé sans le consentement de Eurobex

STANDARD FEATURES ARE NOT LISTED IN THIS HOLE TABLE			
HOLE TABLE - FRONT VIEW (CUSTOM FEATURE ONLY)			
CUT-OUT	XDIM	YDIM	DESCRIPTION
1	105.000	1.000	RND Ø0.201 THREAD 1/4-20 UNC
2	99.000	1.000	RND Ø0.201 THREAD 1/4-20 UNC
3	93.000	1.000	RND Ø0.201 THREAD 1/4-20 UNC
4	87.000	1.000	RND Ø0.201 THREAD 1/4-20 UNC
5	81.000	1.000	RND Ø0.201 THREAD 1/4-20 UNC
6	75.000	1.000	RND Ø0.201 THREAD 1/4-20 UNC
7	69.000	1.000	RND Ø0.201 THREAD 1/4-20 UNC
8	63.000	1.000	RND Ø0.201 THREAD 1/4-20 UNC
9	57.000	1.000	RND Ø0.201 THREAD 1/4-20 UNC
10	51.000	1.000	RND Ø0.201 THREAD 1/4-20 UNC
11	45.000	1.000	RND Ø0.201 THREAD 1/4-20 UNC
12	39.000	1.000	RND Ø0.201 THREAD 1/4-20 UNC
13	33.000	1.000	RND Ø0.201 THREAD 1/4-20 UNC
14	27.000	1.000	RND Ø0.201 THREAD 1/4-20 UNC
15	21.000	1.000	RND Ø0.201 THREAD 1/4-20 UNC
16	15.000	1.000	RND Ø0.201 THREAD 1/4-20 UNC
17	9.000	1.000	RND Ø0.201 THREAD 1/4-20 UNC
18	3.000	1.000	RND Ø0.201 THREAD 1/4-20 UNC

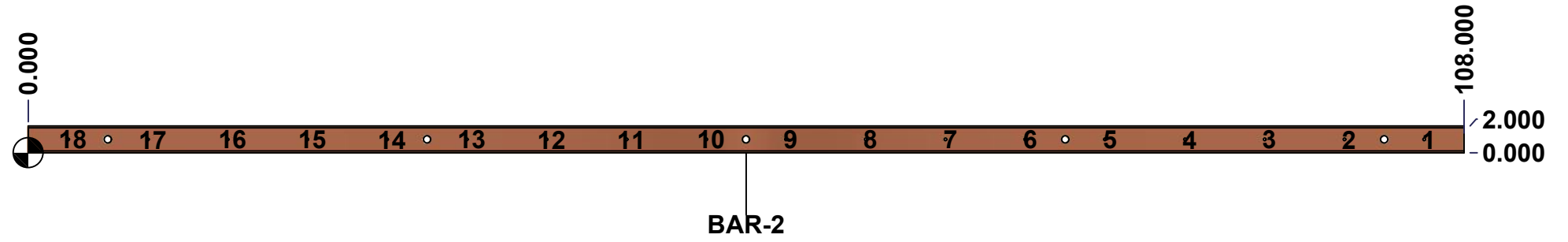

	Description	Status
	Rounded Edge Copper Bar 1/4" x 2"	(NULL)
	Part Number Numéro Pièce	Rev.
	1412BTSSCU12604DTBAR2-P 0	8
		17

This drawing is confidential and must not be reproduced or used without the consent of Eurobex

Ce dessin est confidentiel et ne doit pas être reproduit ou utilisé sans le consentement de Eurobex

STANDARD FEATURES ARE NOT LISTED IN THIS HOLE TABLE			
HOLE TABLE - FRONT VIEW (CUSTOM FEATURE ONLY)			
CUT-OUT	XDIM	YDIM	DESCRIPTION
1	105.000	1.000	RND Ø0.201 THREAD 1/4-20 UNC
2	99.000	1.000	RND Ø0.201 THREAD 1/4-20 UNC
3	93.000	1.000	RND Ø0.201 THREAD 1/4-20 UNC
4	87.000	1.000	RND Ø0.201 THREAD 1/4-20 UNC
5	81.000	1.000	RND Ø0.201 THREAD 1/4-20 UNC
6	75.000	1.000	RND Ø0.201 THREAD 1/4-20 UNC
7	69.000	1.000	RND Ø0.201 THREAD 1/4-20 UNC
8	63.000	1.000	RND Ø0.201 THREAD 1/4-20 UNC
9	57.000	1.000	RND Ø0.201 THREAD 1/4-20 UNC
10	51.000	1.000	RND Ø0.201 THREAD 1/4-20 UNC
11	45.000	1.000	RND Ø0.201 THREAD 1/4-20 UNC
12	39.000	1.000	RND Ø0.201 THREAD 1/4-20 UNC
13	33.000	1.000	RND Ø0.201 THREAD 1/4-20 UNC
14	27.000	1.000	RND Ø0.201 THREAD 1/4-20 UNC
15	21.000	1.000	RND Ø0.201 THREAD 1/4-20 UNC
16	15.000	1.000	RND Ø0.201 THREAD 1/4-20 UNC
17	9.000	1.000	RND Ø0.201 THREAD 1/4-20 UNC
18	3.000	1.000	RND Ø0.201 THREAD 1/4-20 UNC

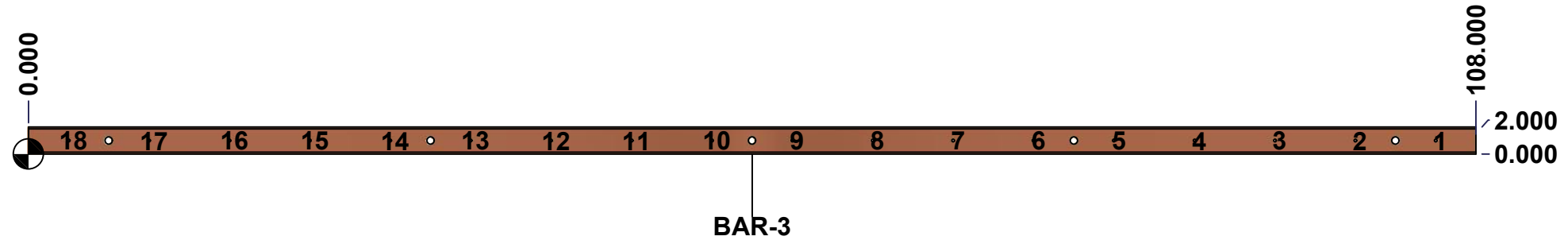

	Description	Status
	Rounded Edge Copper Bar 1/4" x 2"	(NULL)
	Part Number Numéro Pièce	Rev.
	1412BTSSCU12604DTBAR3-P 0	9
		17

This drawing is confidential and must not be reproduced or used without the consent of Eurobex

Ce dessin est confidentiel et ne doit pas être reproduit ou utilisé sans le consentement de Eurobex

STANDARD FEATURES ARE NOT LISTED IN THIS HOLE TABLE			
HOLE TABLE - FRONT VIEW (CUSTOM FEATURE ONLY)			
CUT-OUT	XDIM	YDIM	DESCRIPTION
1	105.000	1.000	RND Ø0.201 THREAD 1/4-20 UNC
2	99.000	1.000	RND Ø0.201 THREAD 1/4-20 UNC
3	93.000	1.000	RND Ø0.201 THREAD 1/4-20 UNC
4	87.000	1.000	RND Ø0.201 THREAD 1/4-20 UNC
5	81.000	1.000	RND Ø0.201 THREAD 1/4-20 UNC
6	75.000	1.000	RND Ø0.201 THREAD 1/4-20 UNC
7	69.000	1.000	RND Ø0.201 THREAD 1/4-20 UNC
8	63.000	1.000	RND Ø0.201 THREAD 1/4-20 UNC
9	57.000	1.000	RND Ø0.201 THREAD 1/4-20 UNC
10	51.000	1.000	RND Ø0.201 THREAD 1/4-20 UNC
11	45.000	1.000	RND Ø0.201 THREAD 1/4-20 UNC
12	39.000	1.000	RND Ø0.201 THREAD 1/4-20 UNC
13	33.000	1.000	RND Ø0.201 THREAD 1/4-20 UNC
14	27.000	1.000	RND Ø0.201 THREAD 1/4-20 UNC
15	21.000	1.000	RND Ø0.201 THREAD 1/4-20 UNC
16	15.000	1.000	RND Ø0.201 THREAD 1/4-20 UNC
17	9.000	1.000	RND Ø0.201 THREAD 1/4-20 UNC
18	3.000	1.000	RND Ø0.201 THREAD 1/4-20 UNC

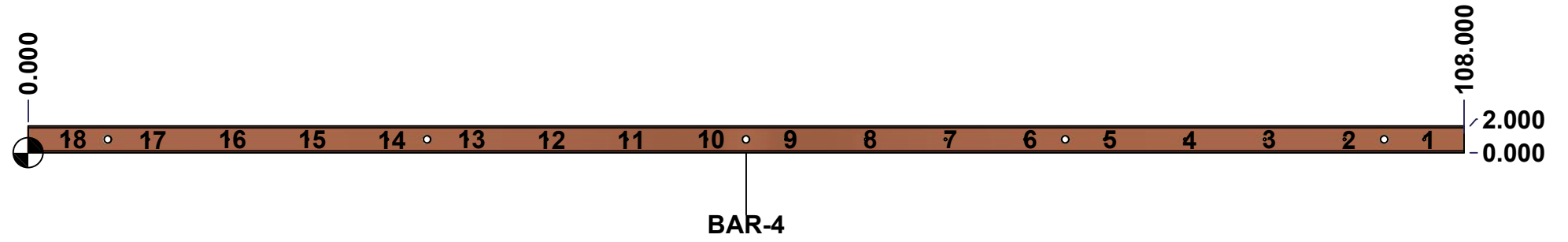

	Description	Status	
	Rounded Edge Copper Bar 1/4" x 2"	(NULL)	
	Part Number	Rev.	10
	Numéro Pièce		
	1412BTSSCU12604DTBAR4-P 0		17

This drawing is confidential and must not be reproduced or used without the consent of EXM

Ce dessin est confidentiel et ne doit pas être reproduit ou utilisé sans le consentement de EXM

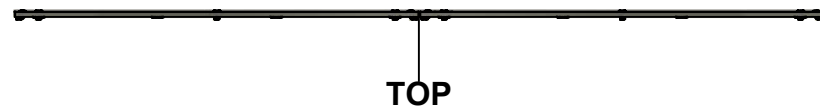

TOP

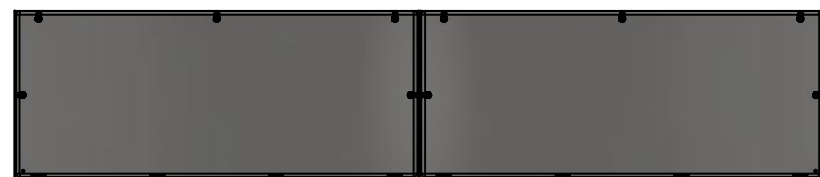

BACK



LEFT

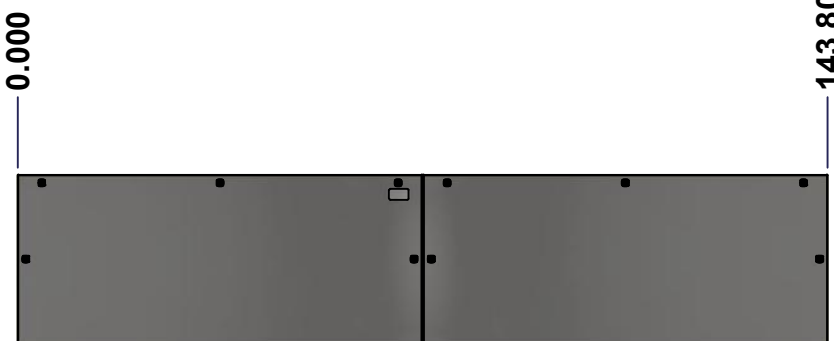

FRONT

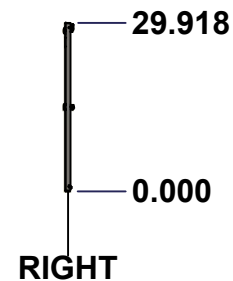

RIGHT



BOTTOM

No.	Revisions	Date	By/Par

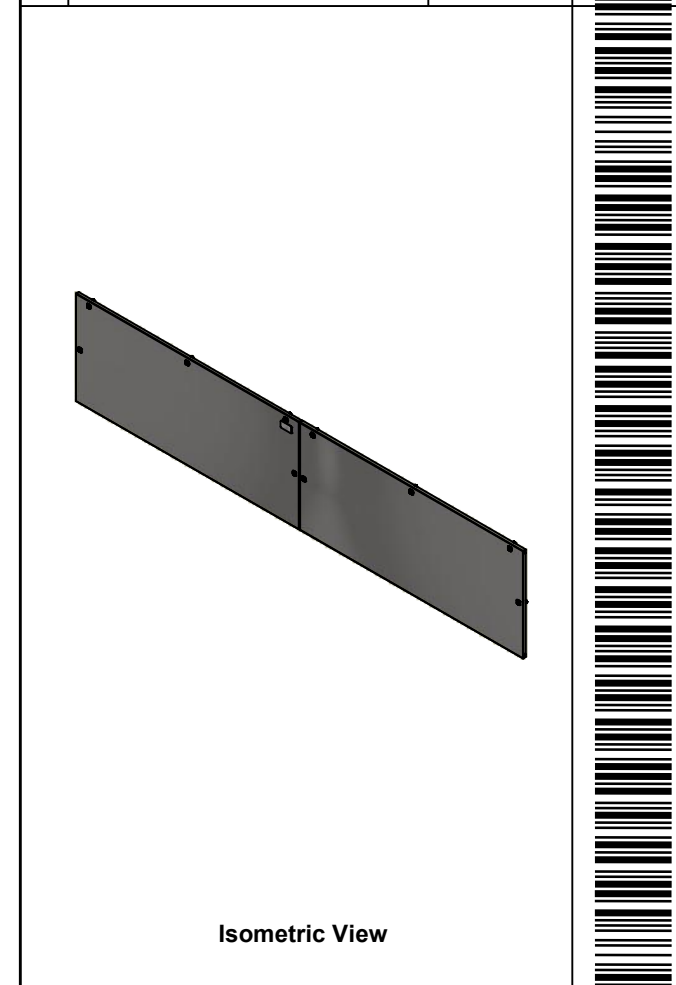

 Tél: (450) 979-4373 Fax: (450) 979-4626 www.exmweb.com		Flatness Aplatissement Max 3.0mm Projection 
Customer Client	Date	
Drawn By Dessiné Par	BoxCad: BoxCad	Date 03-Nov-22
Material Matière	14 Ga Stainless Steel 304 (1.7mm)	
Color Couleur	Unpainted	Finish Fini Brushed
Description 1412BTSSCU 30" x 144" Cover		Detail Rev.
Part Number Numéro Pièce	Rev. 0	11 / 17

SEE BILL OF MATERIAL ON LAST PAGE

1412BTSSCU12604DTC

This drawing is confidential and must not be reproduced or used without the consent of Eurobox

Ce dessin est confidentiel et ne doit pas être reproduit ou utilisé sans le consentement de Eurobox

STANDARD FEATURES ARE NOT LISTED IN THIS HOLE TABLE

HOLE TABLE - FRONT VIEW (CUSTOM FEATURE ONLY)

CUT-OUT	XDIM	YDIM	DESCRIPTION
1	1.500	1.486	GND STUD M6 x 16mm (Inside)
2	142.303	1.486	GND STUD M6 x 16mm (Inside)
3	142.379	14.959	LOCK 880 SCQ4-SLSS6 @ 0.0°
4	73.424	14.959	LOCK 880 SCQ4-SLSS6 @ 180.0°
5	70.379	14.959	LOCK 880 SCQ4-SLSS6 @ 0.0°
6	1.424	14.959	LOCK 880 SCQ4-SLSS6 @ 180.0°
7	139.553	28.494	LOCK 880 SCQ4-SLSS6 @ 90.0°
8	107.902	28.494	LOCK 880 SCQ4-SLSS6 @ 90.0°
9	76.250	28.494	LOCK 880 SCQ4-SLSS6 @ 90.0°
10	67.553	28.494	LOCK 880 SCQ4-SLSS6 @ 90.0°
11	35.902	28.494	LOCK 880 SCQ4-SLSS6 @ 90.0°
12	4.250	28.494	LOCK 880 SCQ4-SLSS6 @ 90.0°

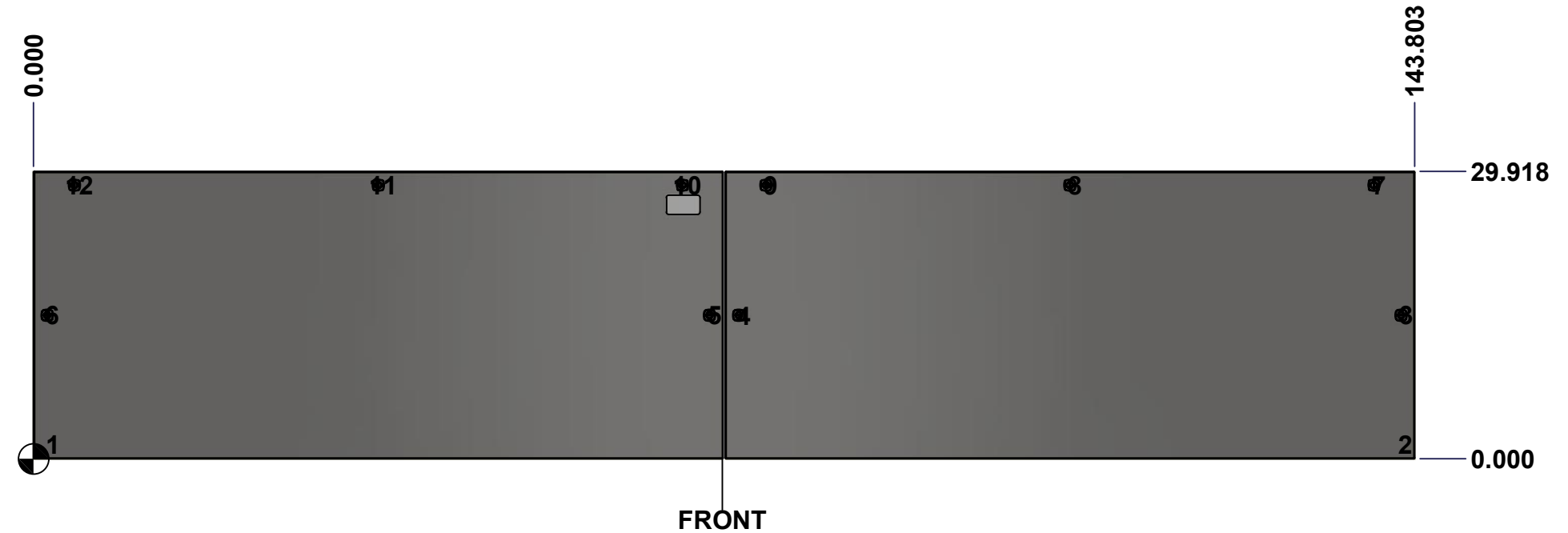

	Description	Status
	1412BTSSCU 30" x 144" Cover	(NULL)
	Part Number Numéro Pièce	Rev.
	1412BTSSCU12604DTC	0
		12
		17

This drawing is confidential and must not be reproduced or used without the consent of EXM

Ce dessin est confidentiel et ne doit pas être reproduit ou utilisé sans le consentement de EXM

No.	Revisions	Date	By/Par

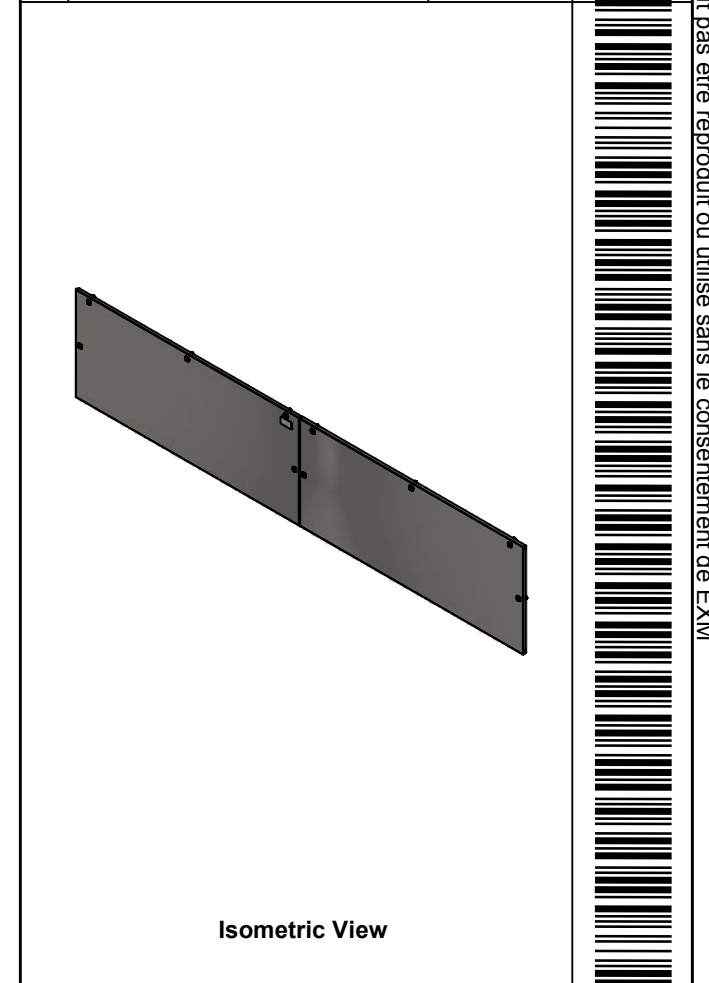

Isometric View

 Tél: (450) 979-4373 Fax: (450) 979-4626 www.exmweb.com	Flatness Aplatissement
	Max 3.0mm
Projection	

Customer Client	Date
Drawn By / Dessiné Par: BoxCad: BoxCad	Date: 03-Nov-22

Material / Matière	14 Ga Stainless Steel 304 (1.7mm)
--------------------	-----------------------------------

Color / Couleur: Unpainted	Finish / Fini: Brushed
----------------------------	------------------------

Description: 1412BTSSCU 30" x 144" Cover	Detail Rev.
--	-------------

Part Number / Numéro Pièce: 1412BTSSCU12604DTC	Rev. 0	13
		17

Qty	Part Name	Rev	Description
2	1412BTSSCU12604DTG	0	1412BTSSCU 30" x 144" Cover Gasket
8	STK-K-09850	6	5412 ESS Hinge with 2 Captive Hinge Pins
2	STK-Q-16095	0	M6 x 16mm Stainless Steel Ground Stud
1	STK-S-00100	0	3.5" x 2" Silver Milar Flexcon Sticker
1	1412BTSSCU12604DTC-P	0	1412BTSSCU 30" x 72" Left Cover Part
1	1412BTSSCU12604DTF-P	0	1412BTSSCU 30" x 144" Right Cover Part
10	880 SCQ4-SLSS6	7	5412 ESS 1/4 Turn Lock
Parts List			

This drawing is confidential and must not be reproduced or used without the consent of EXM

Ce dessin est confidentiel et ne doit pas être reproduit ou utilisé sans le consentement de EXM

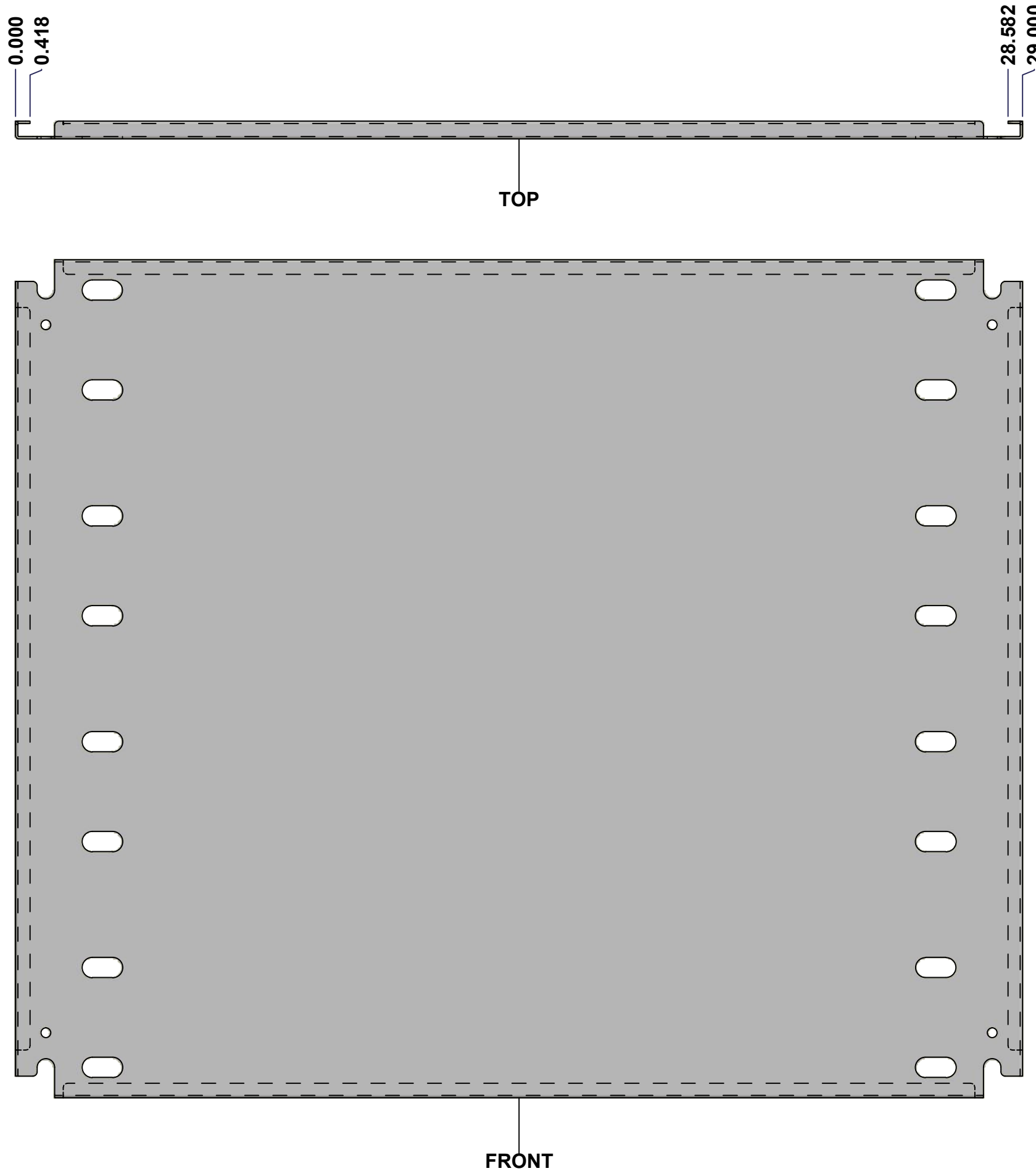

No.	Revisions	Date	By/Par

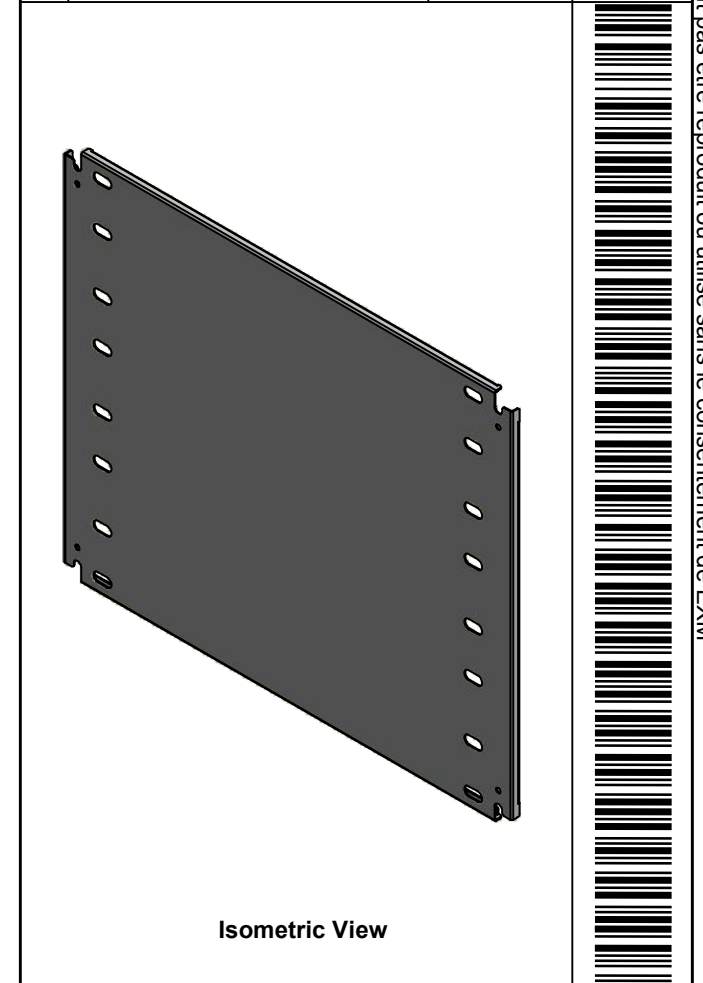

<p>Tél: (450) 979-4373 Fax: (450) 979-4626 www.exmweb.com</p>	Flatness Aplatissement Max 3.0mm
	Projection
Customer Client	Date
Drawn By Dessiné Par BoxCad: BoxCad	Date 03-Nov-22
Material Matière 14 Ga Cold Rolled A1008 CS Type B (1.7mm)	
Color Couleur White RAL9003	Finish Fini Smooth
Description 1412BTSSCU 24.125" x 29" Left Inner Panel	
Part Number Numéro Pièce 1412BTSSCU12604DTIP1	Detail Rev. Rev. 14 0

SEE BILL OF MATERIAL ON LAST PAGE

This drawing is confidential and must not be reproduced or used without the consent of EXM

Ce dessin est confidentiel et ne doit pas être reproduit ou utilisé sans le consentement de EXM

No.	Revisions	Date	By/Par

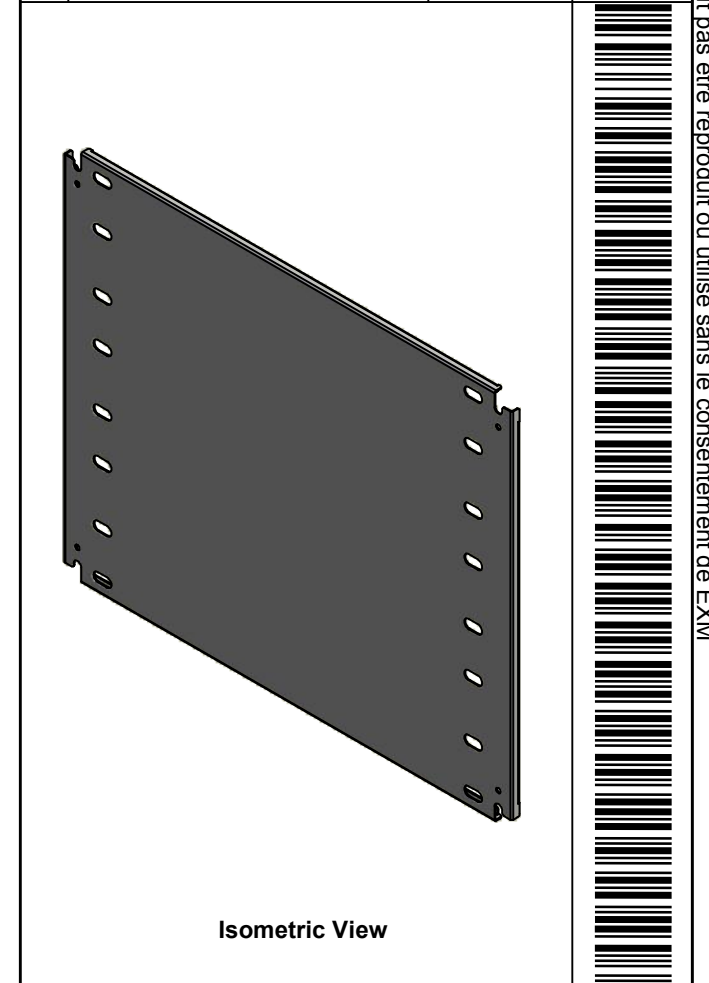

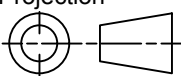
 Tél: (450) 979-4373 Fax: (450) 979-4626 www.exmweb.com		Flatness Aplatissement Max 3.0mm Projection 
Customer Client	Date	
Drawn By Dessiné Par	BoxCad: BoxCad	Date 03-Nov-22
Material Matière	14 Ga Cold Rolled A1008 CS Type B (1.7mm)	
Color Couleur	White RAL9003	Finish Fini Smooth
Description		Detail Rev.
1412BTSSCU 24.125" x 29" Left Inner Panel		
Part Number Numéro Pièce	Rev.	15
1412BTSSCU12604DTIP1	0	17

Qty	Part Number	Rev	Description
1	STK-P-02401S	0	Powder Paint (White / Smooth)
1	1412BTSSCU12604DTIP1-P	0	1412BTSSCU 24.125" x 144" Left Inner Panel Part
Parts List			

This drawing is confidential and must not be reproduced or used without the consent of EXM

Ce dessin est confidentiel et ne doit pas être reproduit ou utilisé sans le consentement de EXM



TOP

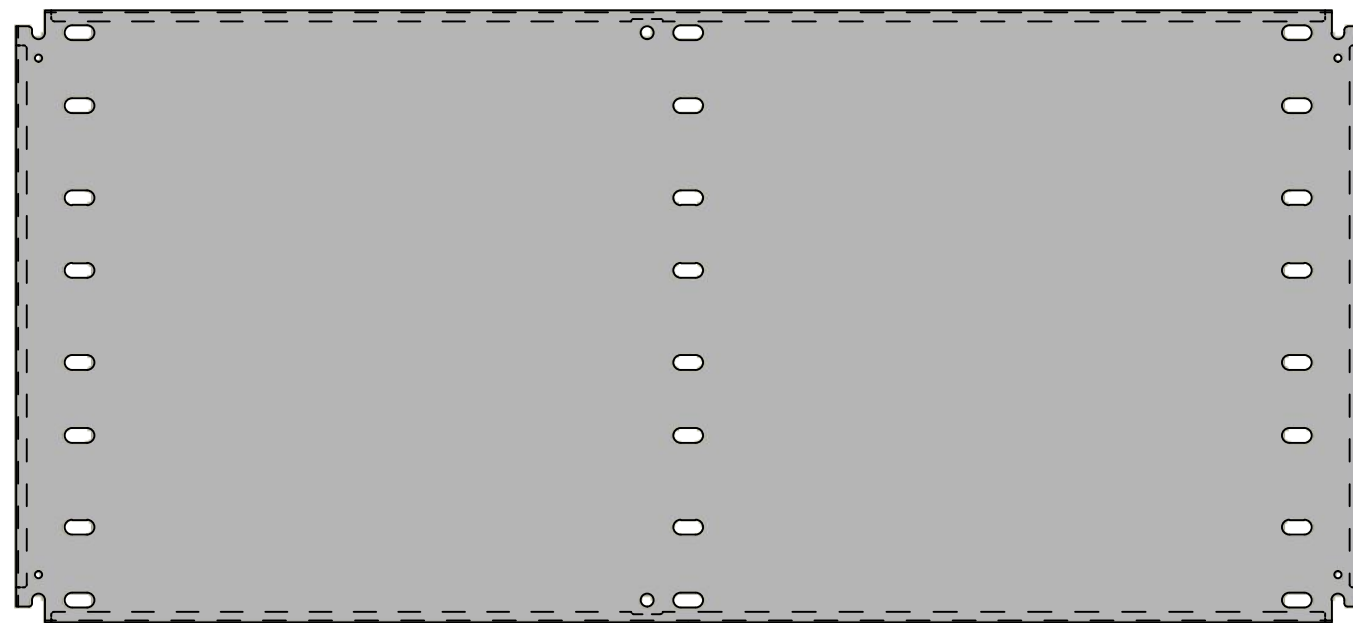

FRONT

24.125
23.707



RIGHT

0.418
0.000

No.	Revisions	Date	By/Par

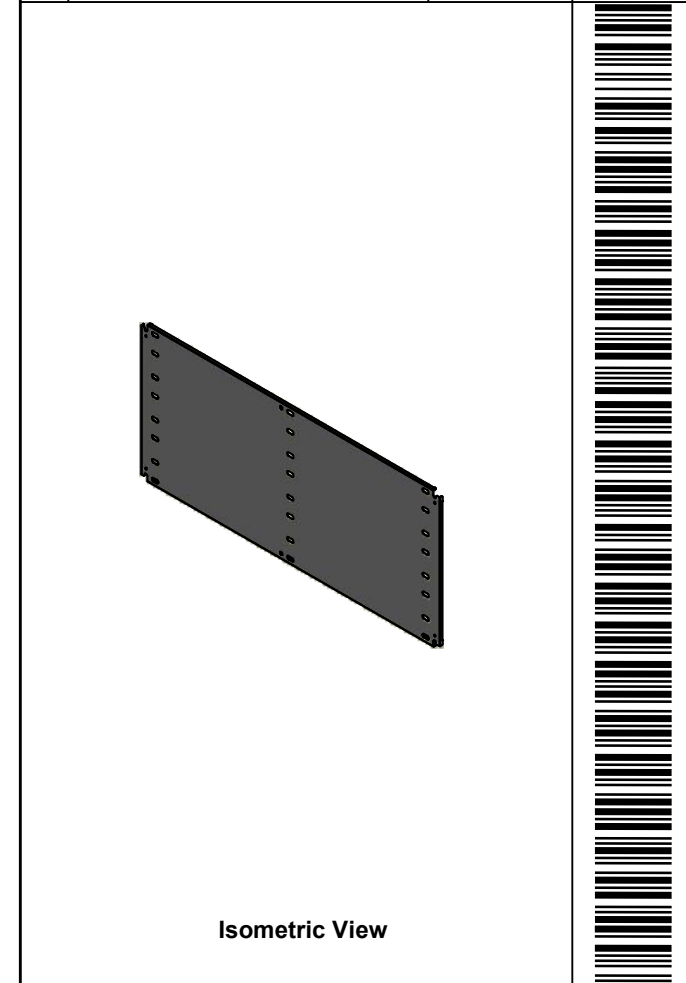

Isometric View

 Tél: (450) 979-4373
 Fax: (450) 979-4626
www.exmweb.com

Flatness / Aplatissement: Max 3.0mm
 Projection: 

Customer Client	Date
Drawn By / Dessiné Par: BoxCad: BoxCad	Date: 03-Nov-22
Material / Matière: 14 Ga Cold Rolled A1008 CS Type B (1.7mm)	
Color / Couleur: White RAL9003	Finish / Fini: Smooth
Description: 1412BTSSCU 24.125" x 53" Right Inner Panel	Detail Rev.
Part Number / Numéro Pièce: 1412BTSSCU12604DTIP2	Rev. 0

SEE BILL OF MATERIAL ON LAST PAGE

This drawing is confidential and must not be reproduced or used without the consent of EXM

Ce dessin est confidentiel et ne doit pas être reproduit ou utilisé sans le consentement de EXM

No.	Revisions	Date	By/Par

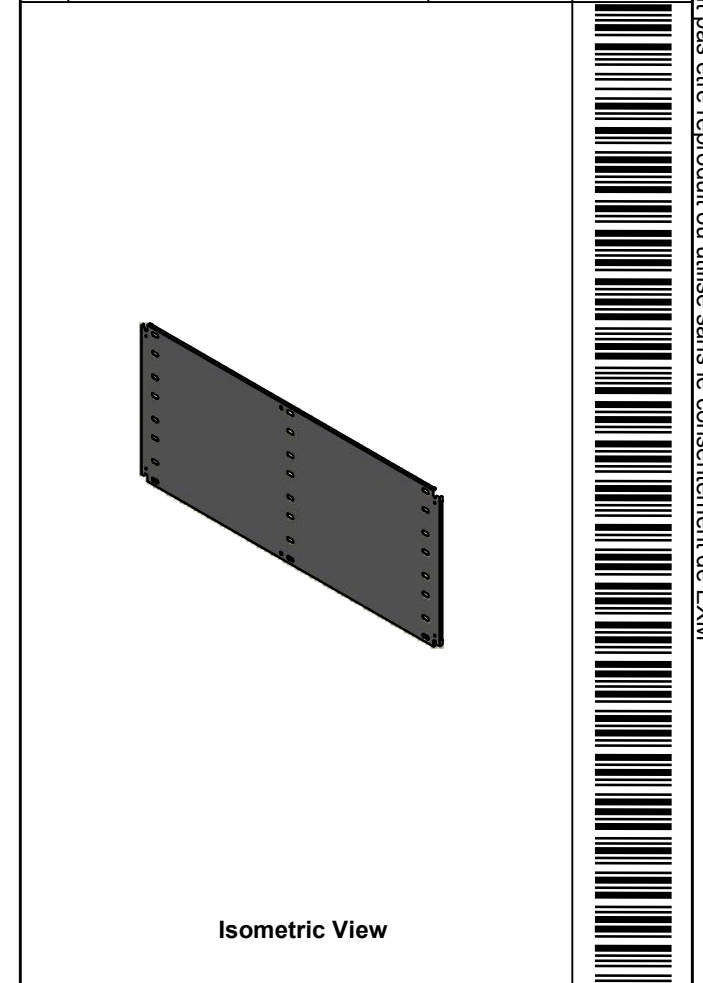

 Tél: (450) 979-4373 Fax: (450) 979-4626 www.exmweb.com	Flatness Aplatissement	Max 3.0mm
	Projection	

Customer Client	Date
Drawn By / Dessiné Par: BoxCad: BoxCad	Date: 03-Nov-22
Material / Matière: 14 Ga Cold Rolled A1008 CS Type B (1.7mm)	

Color / Couleur: White RAL9003	Finish / Fini: Smooth
--------------------------------	-----------------------

Qty	Part Number	Rev	Description
1	STK-P-02401S	0	Powder Paint (White / Smooth)
1	1412BTSSCU12604DTIP2-P	0	1412BTSSCU 24.125" x 144" Right Inner Panel Part
Parts List			

Description: 1412BTSSCU 24.125" x 53" Right Inner Panel	Detail Rev.
Part Number / Numéro Pièce: 1412BTSSCU12604DTIP2	Rev. 0
	17 / 17