

This drawing is confidential and must not be reproduced or used without the consent of EXM

Ce dessin est confidentiel et ne doit pas être reproduit ou utilisé sans le consentement de EXM

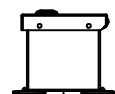

TOP

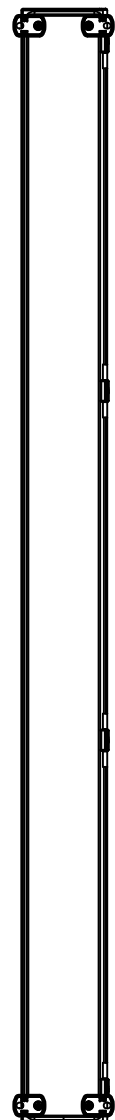

BACK

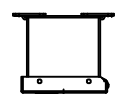

BOTTOM

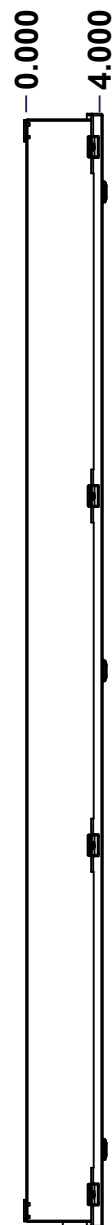

LEFT

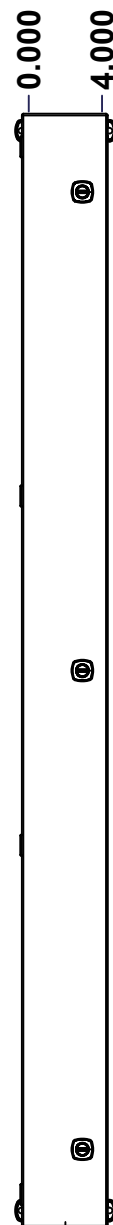

FRONT

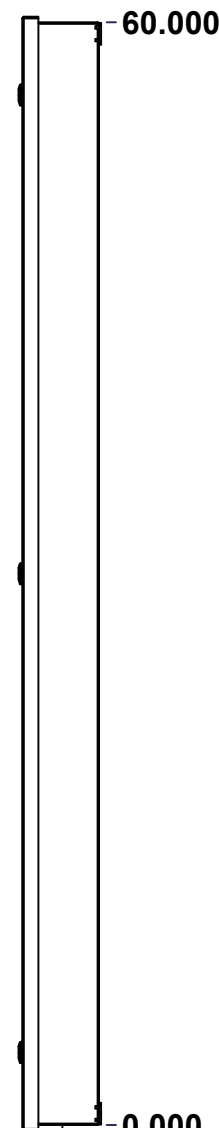

RIGHT

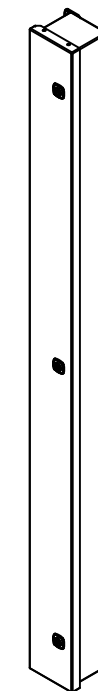

Isometric View



No.	Revisions	Date	By/Par

 Tél: (450) 979-4373 Fax: (450) 979-4626 <a href="http://www.exmweb.com">www.exmweb.com</a>		Flatness Aplatissement Max 3.0mm Projection 
Customer Client	Date	Date
Drawn By Dessiné Par	BoxCad: BoxCad	Date 16-Jan-14
Material Matière	16 Ga Cold Rolled A1008 CS Type B (1.4mm)	
Color Couleur	Asa-61 Grey	Finish Fini Smooth
Description	1412CH 60" x 4" x 4" Assembly	
Part Number Numéro Pièce	Rev. 0	1 2

SEE BILL OF MATERIAL ON LAST PAGE

**1412CH040460**

This drawing is confidential and must not be reproduced or used without the consent of EXM

Ce dessin est confidentiel et ne doit pas être reproduit ou utilisé sans le consentement de EXM

NOTE	
ITEM	DESCRIPTION
1	NEMA 4/12 Enclosure
2	C/W Standard ground standoffs on box and cover
3	W/O Standard door stiffener
4	W/O Inner panel
5	W/O Inner panel mounting standoffs

No.	Revisions	Date	By/Par

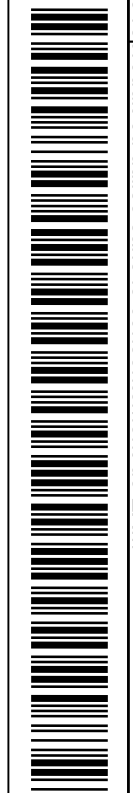
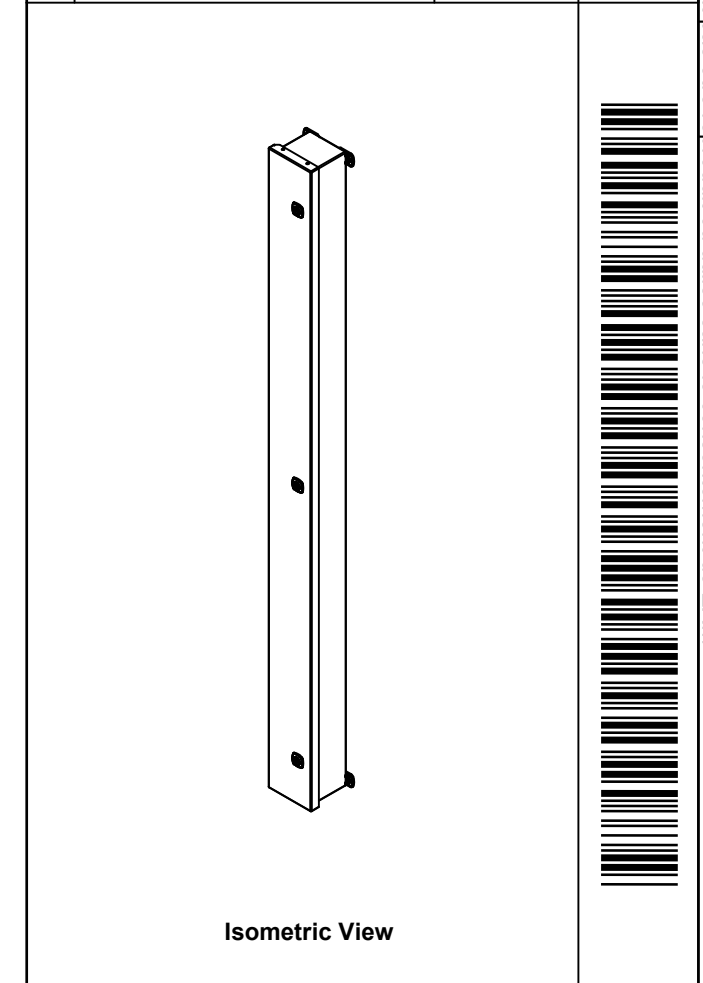

	Tél: (450) 979-4373 Fax: (450) 979-4626 <a href="http://www.exmweb.com">www.exmweb.com</a>	Flatness Aplatissement
		Max 3.0mm
Projection		
Customer Client	Date	
Drawn By Dessiné Par	BoxCad: BoxCad	Date 16-Jan-14
Material Matière	16 Ga Cold Rolled A1008 CS Type B (1.4mm)	
Color Couleur	Asa-61 Grey	Finish Fini Smooth

PACKING		
ITEM	QTY	DESCRIPTION
Cardboard sleeve	1	Top
Thermal plastic film	1	Use with Packing Tunnel Wrapper Machine
Packaging label	1	White label with product number

Qty	Part Number	Rev	Description
1	1412CH040460C	0	1412CH 60" x 4" Cover
1	1412CH040460B	0	1412CH 60" x 4" x 4" Body
2	STK-K-02570	0	1412 CH Accessory Kit
4	STK-Q-08100	1	M5 Nylon Insert Lock Nut
Parts List			

Description	Detail Rev.
1412CH 60" x 4" x 4" Assembly	
Part Number Numéro Pièce	Rev.
<b>1412CH040460</b>	<b>0</b>
	2
	2

This drawing is confidential and must not be reproduced or used without the consent of EXM

Ce dessin est confidentiel et ne doit pas être reproduit ou utilisé sans le consentement de EXM

TOP



BACK



BOTTOM

0.000  
4.000



LEFT

0.000  
4.000



FRONT

60.000

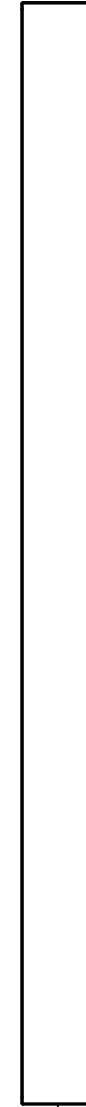

RIGHT

0.000

No.	Revisions	Date	By/Par

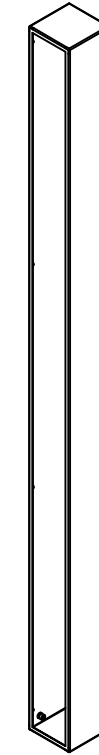

Isometric View



Tél: (450) 979-4373  
Fax: (450) 979-4626  
[www.exmweb.com](http://www.exmweb.com)

Flatness  
Aplatissement

Max 3.0mm

Projection

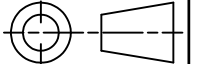

Customer Client	Date
Drawn By Dessiné Par BoxCad: BoxCad	Date 16-Jan-14
Material Matière 16 Ga Cold Rolled A1008 CS Type B (1.4mm)	
Color Couleur Asa-61 Grey	Finish Fini Smooth
Description 1412CH 60" x 4" x 4" Body	Detail Rev.
Part Number Numéro Pièce <b>1412CH040460B</b>	Rev. 0

SEE BILL OF MATERIAL ON LAST PAGE

1  
7

This drawing is confidential and must not be reproduced or used without the consent of EXM

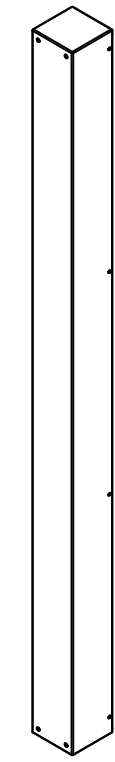

Ce dessin est confidentiel et ne doit pas être reproduit ou utilisé sans le consentement de EXM

No.	Revisions	Date	By/Par



Isometric View

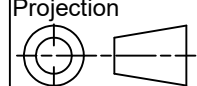

 Tél: (450) 979-4373 Fax: (450) 979-4626 <a href="http://www.exmweb.com">www.exmweb.com</a>		Flatness Aplatissement  Max 3.0mm Projection 
Customer Client	Date	
Drawn By Dessiné Par	BoxCad: BoxCad	Date 16-Jan-14
Material Matière	16 Ga Cold Rolled A1008 CS Type B (1.4mm)	
Color Couleur	Asa-61 Grey	Finish Fini Smooth
Description		Detail Rev.
1412CH 60" x 4" x 4" Body		
Part Number Numéro Pièce	Rev.	7
<b>1412CH040460B</b>	<b>0</b>	7

Qty	Part_Number	Rev	Description
1	1412CH040460B-P	0	1412CH 60" x 4" x 4" Body Part
1	STK-P-02400S	0	Powder Paint (Asa-61 Grey / Smooth)
1	STK-Q-08350	5	Standoff M6 x 10mm
Parts List			

This drawing is confidential and must not be reproduced or used without the consent of EXM

Ce dessin est confidentiel et ne doit pas être reproduit ou utilisé sans le consentement de EXM

TOP

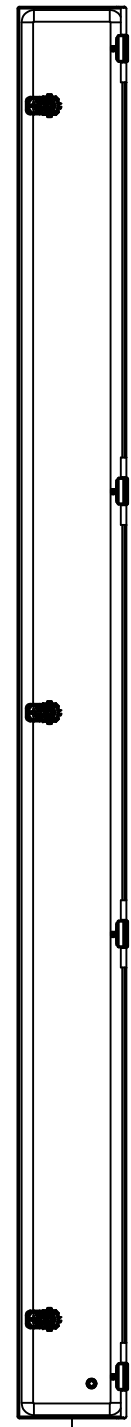

BACK

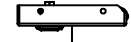

BOTTOM

0.000  
0.875

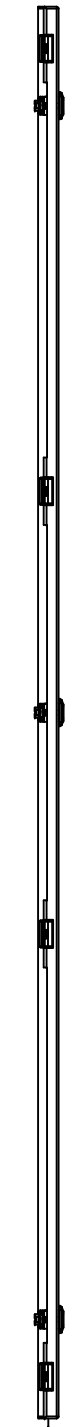

LEFT

0.000  
4.687

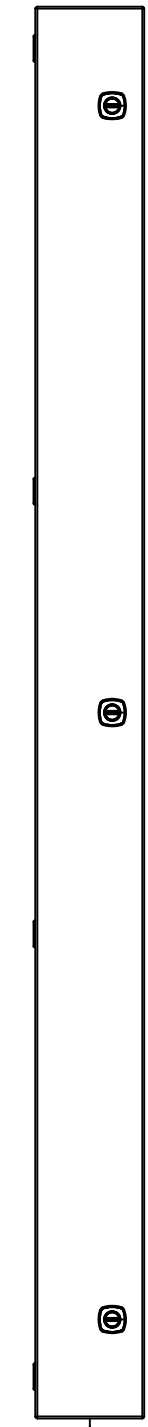

FRONT

60.592



RIGHT

0.000

No.	Revisions	Date	By/Par

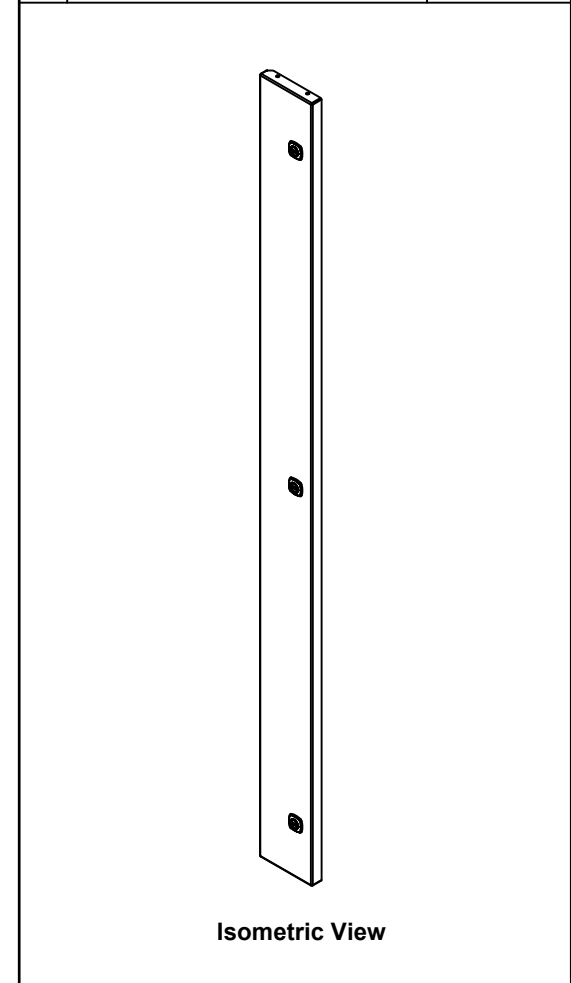

Isometric View

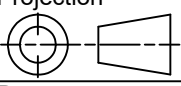

 Tél: (450) 979-4373 Fax: (450) 979-4626 <a href="http://www.exmweb.com">www.exmweb.com</a>		Flatness Aplatissement Max 3.0mm Projection 
Customer Client	Date	Date 16-Jan-14
Drawn By Dessiné Par	BoxCad: BoxCad	
Material Matière	16 Ga Cold Rolled A1008 CS Type B (1.4mm)	
Color Couleur	Asa-61 Grey	Finish Fini Smooth
Description	Detail Rev.	
1412CH 60" x 4" Cover		
Part Number Numéro Pièce	Rev.	1 3
<b>1412CH040460C</b>		<b>0</b>

SEE BILL OF MATERIAL ON LAST PAGE

This drawing is confidential and must not be reproduced or used without the consent of EXM

Ce dessin est confidentiel et ne doit pas être reproduit ou utilisé sans le consentement de EXM

STANDARD FEATURES ARE NOT LISTED IN THIS HOLE TABLE			
HOLE TABLE - FRONT VIEW (CUSTOM FEATURE ONLY)			
CUT-OUT	XDIM	YDIM	DESCRIPTION
1	3.307	56.342	LOCK 880 SCQ4CH-SL @ 180.0°
2	3.307	30.296	LOCK 880 SCQ4CH-SL @ 180.0°
3	3.307	4.250	LOCK 880 SCQ4CH-SL @ 180.0°

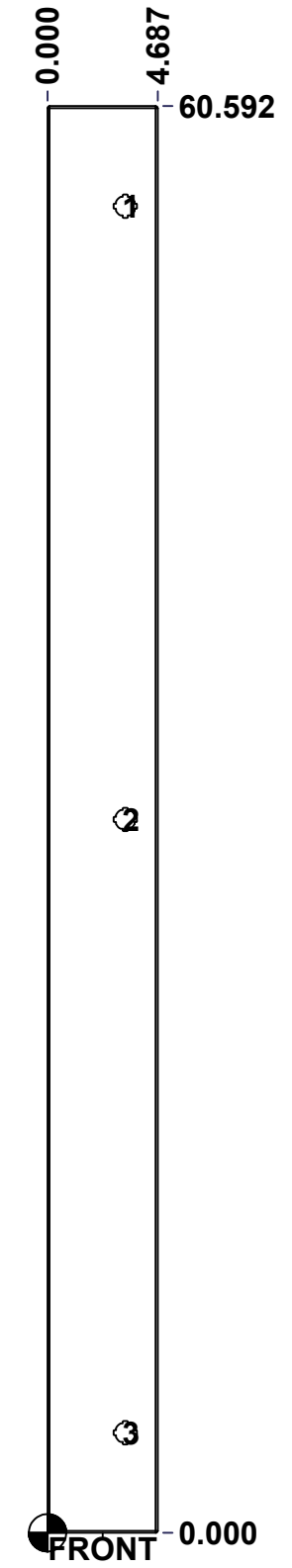



	Description	Status	
	1412CH 60" x 4" Cover	(NULL)	
	Part Number Numéro Pièce	Rev.	
	<b>1412CH040460C</b>	<b>0</b>	2 / 3

This drawing is confidential and must not be reproduced or used without the consent of EXM

Ce dessin est confidentiel et ne doit pas être reproduit ou utilisé sans le consentement de EXM

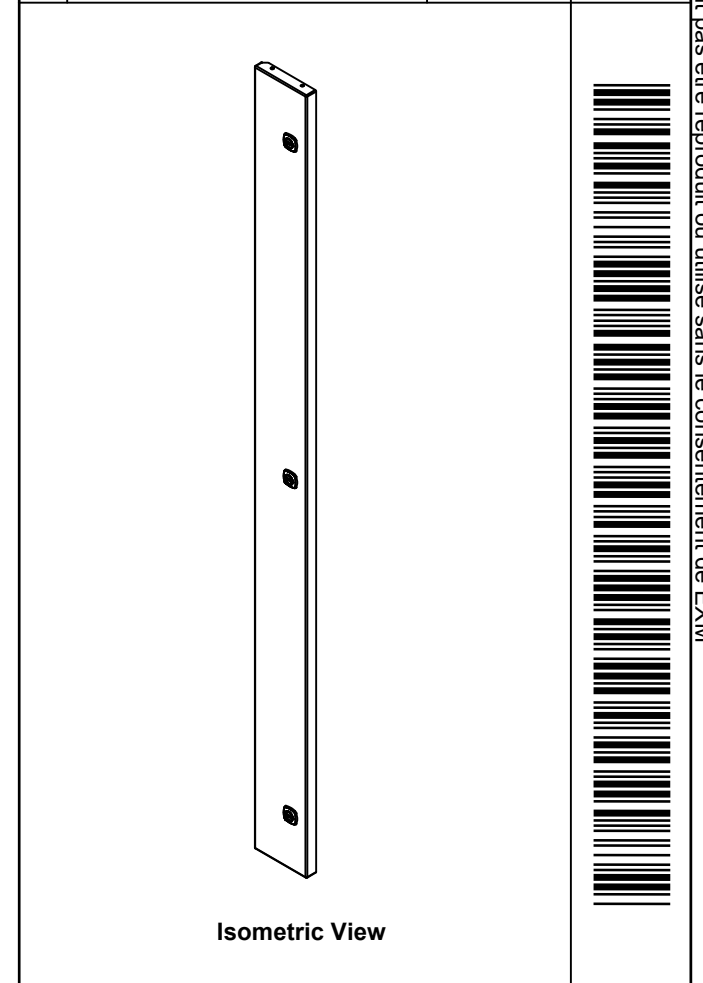
No.	Revisions	Date	By/Par

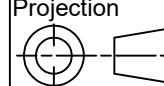

 Tél: (450) 979-4373 Fax: (450) 979-4626 <a href="http://www.exmweb.com">www.exmweb.com</a>		Flatness Aplatissement  Max 3.0mm Projection 	
Customer Client		Date	
Drawn By / Dessiné Par: BoxCad: BoxCad		Date: 16-Jan-14	
Material / Matière: 16 Ga Cold Rolled A1008 CS Type B (1.4mm)			
Color / Couleur: Asa-61 Grey		Finish / Fini: Smooth	
Description: 1412CH 60" x 4" Cover			Detail Rev.
Part Number / Numéro Pièce: <b>1412CH040460C</b>			Rev. 3

Qty	Part Number	Rev	Description
1	1412CH040460G	0	1412CH 60" x 4" Gasket
1	STK-P-02400S	0	Powder Paint (Asa-61 Grey / Smooth)
1	STK-Q-08350	5	Standoff M6 x 10mm
1	1412CH040460C-P	0	1412CH 60" x 4" Cover Part
4	STK-A-33033	4	5412 ESMCH Hinge
3	880 SCQ4CH-SL	0	5412 CH 1/4 Turn Lock
Parts List			